

view without cover  
(2:1)

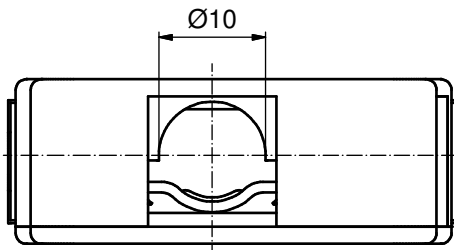

COUNTERSUNK HEAD SCREWS  
(6x)

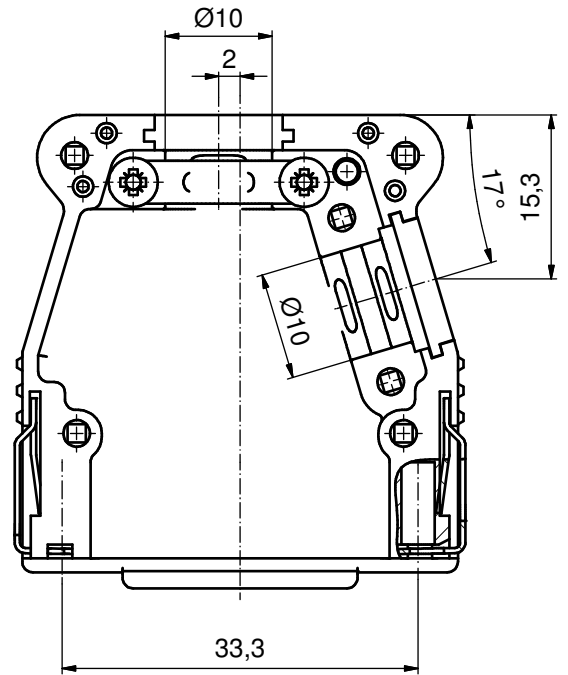
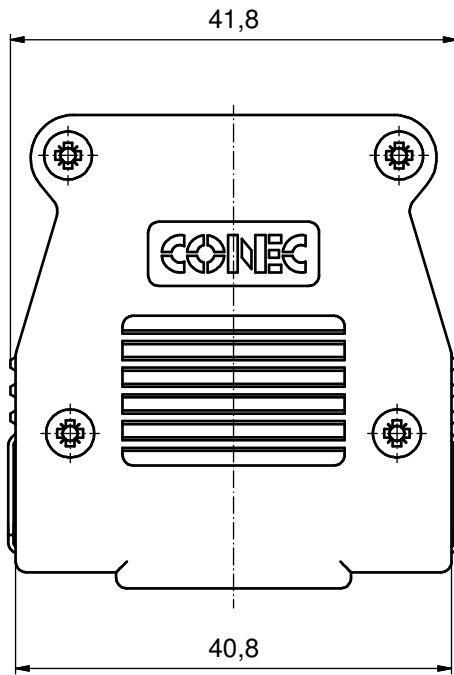
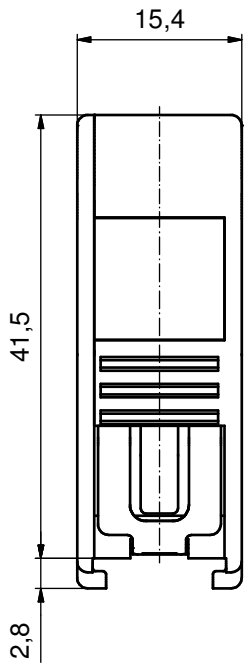

CABLE STRAIN RELIEF

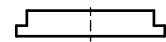

BLANKING PLUG

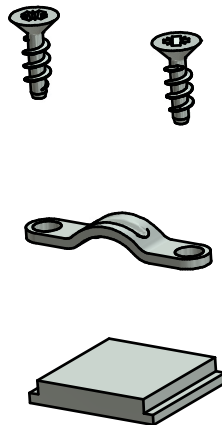
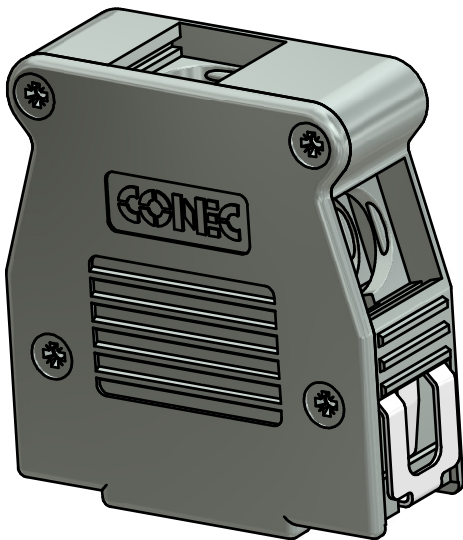

(b)	Part-No.	Part-No.
	Bulk package	Single package
	16-001760	16-001760E

**HOOD ASSEMBLY CONSISTS OF:**

1. HOOD + COVER: ABS UL 94 V-0; NICKEL PLATED
2. BLANKING PLUGS: ABS UL 94 V-0; NICKEL PLATED
3. CABLE STRAIN RELIEF: STEEL; NICKEL PLATED
4. CLIP: STAINLESS STEEL
5. COUNTERSUNK HEAD SCREWS: STEEL; NICKEL PLATED

RoHS compliant

THIS DRAWING MAY NOT BE COPIED OR REPRODUCED IN ANY WAY, AND MAY NOT BE PASSED ON TO A THIRD PARTY WITHOUT WRITTEN PERMISSION. OWNERSHIP AND COPYRIGHT OF CONEC GmbH DO NOT ALTER CAD DRAWING BY HAND				tolerance		scale:	2:1	
					dim. in mm	material:	see drawing	
				date	name	title:		
				drawn	24.09.14			Henneboel
				appd.	24.09.14			Strakerjahn
				norm			Plastic Hood 15pos with Snap Lock / top and side cable exit	
			d-old					
2 x b	Ä5619	22.04.2015	K.H.			dwg no:	DIN-A3	
a	Original					16K1A3530	sh: 1	
rev.	description	date	name			part no:	(b) SEE TABLE	

# Mouser Electronics

Authorized Distributor

Click to View Pricing, Inventory, Delivery & Lifecycle Information:

[CONEC:](#)

[16-001760E](#)