

# Surface Mount PTC

## OZCK Series

HF  OZCK Series – 0805 Chip

RoHS 2 Compliant

### Product Features

- 0805 Chip Size, Fast Trip Time, Low DCR Resistance
- AEC-Q Compliant
- Meets Bel automotive qualification\*
- \* - Largely based on internal AEC-Q test plan

### Operating (Hold Current) Range

100mA – 1.1A

### Maximum Voltage

6 - 24V (per table)

### Temperature Range



-40°C to 85°C

### Agency Approval



TUV (Std. EN/IEC 60738-1-1 and EN/IEC 60730-1, Cert. R50102117)  
UL Recognized Component (Std. UL1434, File E305051)



**AEC-Q Compliant**

LEAD FREE =   
HALOGEN FREE = 

### Electrical Characteristics (23°C)

	Part Number	Hold Current	Trip Current	Rated Voltage	Maximum Current	Typical Power	Max Time to Trip		Resistance Tolerance		Agency Approvals	
							Current	Time	Rmin	R1max		
							A	Sec	Ohms	Ohms		
New Rating	A 0ZCK0010FF2G	0.10	0.30	15	100	0.5	0.50	1.50	0.700	6.000	Y	Y
	0ZCK0010AF2G	0.10	0.30	24	100	0.5	0.50	1.50	0.700	6.000	Y	Y
	B 0ZCK0020FF2G	0.20	0.50	9	100	0.5	8.00	0.02	0.400	3.500	Y	Y
	C 0ZCK0035FF2G	0.35	0.75	6	100	0.5	8.00	0.10	0.250	1.200	Y	Y
	D 0ZCK0050FF2E	0.50	1.00	6	100	0.5	8.00	0.10	0.150	0.850	Y	Y
	0ZCK0050AF2E	0.50	1.00	9	100	0.5	8.00	0.10	0.150	0.850	Y	Y
	E 0ZCK0075FF2E	0.75	1.50	6	40	0.6	8.00	0.20	0.090	0.350	Y	Y
	F 0ZCK0100FF2E	1.00	1.95	6	40	0.6	8.00	0.30	0.060	0.210	Y	Y
New Rating	G 0ZCK0110FF2E	1.10	2.20	6	100	0.6	8.00	0.20	0.050	0.200	Y	Y

IH Hold Current- The maximum current at which the device will not trip in still air at 23°C.

IT Trip current- The minimum current at which the device will trip in still air at 23°C.

Vmax Maximum voltage device can withstand at its rated current without suffering damage.

Imax Maximum fault current device can withstand at rated voltage (Vmax) without damage.

Pd Typical power dissipated by device when in tripped state in 23°C still air environment.

Rmin Minimum device resistance at 23°C in initial un-soldered state.

R1max Maximum device resistance at 23°C, 1 hour after initial device trip, or after being soldered to PCB in end application

Specifications subject to change without notice

## PTC's – Basic Theory of Operation / “Tripped” Resistance Explanation

A Bel PTC consists of a block of polymeric material containing conductive carbon granules which is sandwiched between two conductive metal plates. When this polymer block reaches approximately 125C, either due to current passing through it via conductive chains of carbon particles or due to an external heat source; it swells volumetrically. This expansion breaks apart a majority of the chains of carbon granules that run randomly between the two conductive plates. This behavior results in a sharp increase in resistance across the two plates which all but eliminates current flow through the device, allowing just enough residual current flow to maintain the block's internal temperature at 125C. Once this “tripped” state current is cut off, the polymer brick cools and shrinks to its original size, thereby allowing its broken carbon chains to reestablish themselves and permit the part to return to its low resistance state. Once cooled to room ambient, the PTC will once again exhibit a resistance less than its “R1max” rating.

At currents below the device I<sub>HOLD</sub> rating, AND at temperatures below 100C, the PTC maintains a resistance value below its R1 MAX rating.

The catalog data for each device specifies a "Typical Power" value. This is the power required to exactly match the heat lost by the tripped device to its ambient surroundings at 23C. By Ohm's Law, power can be stated as:  $W = E^2/R$ . Thus the approximate resistance of a “Tripped” PTC can be determined by:  $R = E^2/W$ , where "E" is the voltage appearing across the PTC (usually the supply's open circuit voltage), and "W" is the Typical Power value for the particular PTC.

Since the PPTC acts to maintain a constant internal temperature, its apparent resistance will change based upon applied voltage and, to a lesser degree, ambient conditions. Consider the following example....

A PTC with a Typical Power of 1 watt protecting a circuit using a 60V supply will demonstrate an apparent, tripped resistance "R" of:

$$R = 60^2/1 = 3,600 \text{ ohms}$$

This same tripped device when used to protect a 12V circuit would now present an apparent resistance of:

$$R = 12^2/1 = 144 \text{ ohms}$$

The value for Typical Power is "typical" because any physical factors that affect heat loss (such as ambient temperature or air convection) will somewhat alter the level of power that the PTC needs to maintain its internal temperature. In short, PTCs do not exhibit a constant, quantifiable tripped resistance value.

## Average Time Current Characteristic Curve at 23°C

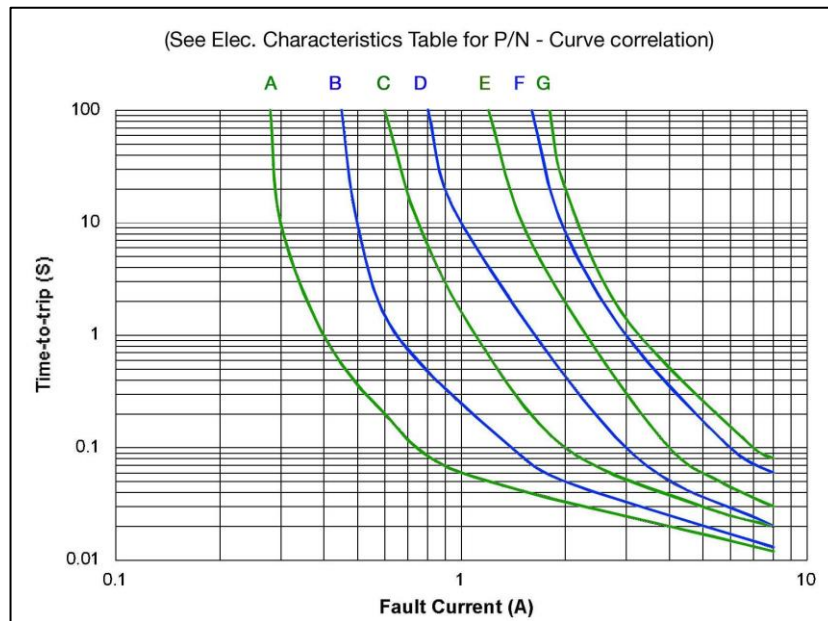

The Average Time Current Characteristic Curve and Temperature Rerating Curve are affected by a number of variables and these curves are provided for guidance only.



Specifications subject to change without notice

Bel Fuse Inc.  
206 Van Vorst Street  
Jersey City, NJ 07302 USA

+1 201.432.0463  
Bel.US.CS@belf.com  
[belfuse.com/circuit-protection](http://belfuse.com/circuit-protection)

## Pad Layout

The dimensions in the table below provide the recommended pad layout.

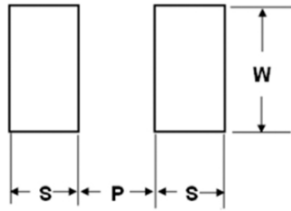

P		S		W	
Nominal		Nominal		Nominal	
mm	Inch	mm	Inch	mm	Inch
1.20	0.047	1.00	0.039	1.50	0.059

## Termination Pad Materials

Matte Tin – Plated Copper

## Mechanical Dimensions and Marking

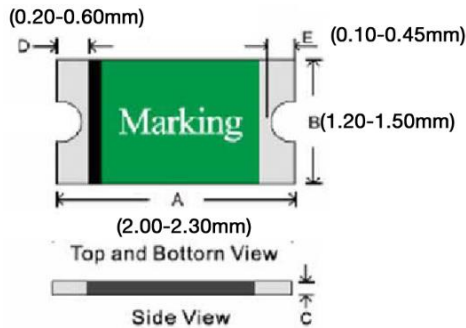

All dimensions in mm.

Part Number	Dimensions		Marking Code
	Min	Max	
0ZCK0010FF2G	0.30	1.00	D
0ZCK0010AF2G	0.30	1.00	d
0ZCK0020FF2G	0.30	1.00	F
0ZCK0035FF2G	0.25	0.75	J
0ZCK0050FF2E	0.55	1.25	M
0ZCK0050AF2E	0.55	1.25	N
0ZCK0075FF2E	0.55	1.25	P
0ZCK0100FF2E	0.75	1.80	1
0ZCK0110FF2E	0.75	1.80	R

## Temperature Derating Table

I Hold Value	Temperature Derating									
	-40	-20	0	23	30	40	50	60	70	85
0010	167%	145%	123%	100%	93%	83%	73%	63%	54%	40%
0020 thru 0110	134%	123%	113%	100%	92%	81%	78%	75%	64%	49%

## Thermal Derating Curve

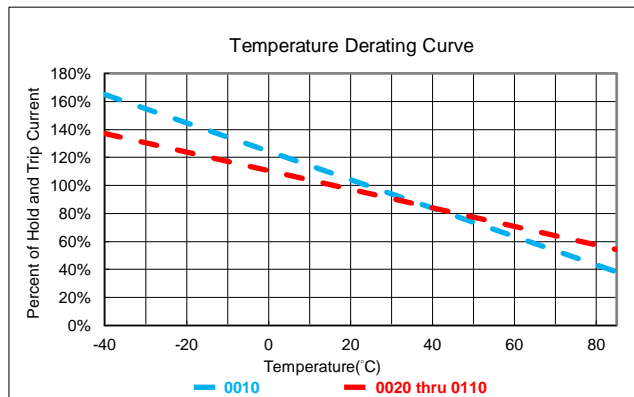

## Cautionary Notes

1. Operation beyond the specified maximum ratings or improper use may result in damage and possible electrical arcing and/or flame.
2. These Polymer PTC (PPTC) devices are intended for protection against occasional overcurrent/overtemperature fault conditions and may not be suitable for use in applications where repeated and/or prolonged fault conditions are anticipated.
3. Avoid contact of PTC device with chemical solvent. Prolonged contact may adversely impact the PTC performance.
4. These PTC devices may not be suitable for use in circuits with a large inductance, as the PTC trip can generate circuit voltage spikes above the PTC rated voltage.
5. These devices may be used in both DC and AC circuits provided that peak-to-peak line voltage when carrying AC does not exceed the PTC's Vmax rating. As PTCs are essentially thermal devices, the RMS value of AC current carried by a PTC will produce tripping parameters and times-to-trip similar to those of a DC voltage of the same magnitude.
6. If potting is mandated, avoid rigid potting compounds as they will encase the PTC and prevent it from volumetrically expanding to properly respond to a trip event.
7. MSL: 2a (According to IPC J-Std-020).

## Environmental Specifications

Temperature cycling	JESD22 Method JA-104
Biased humidity	MIL-STD-202 Method 103
Operational life	MIL-STD-202 Method 108
Resistance to solvents	MIL-STD-202 Method 215
Mechanical shock	MIL-STD-202 Method 213
Vibration	MIL-STD-202 Method 204
Resistance to soldering heat	MIL-STD-202 Method 210
Thermal shock	MIL-STD-202 Method 107
Solderability	ANSI/J-STD-002
Board flex(SMD)	AEC-Q200-005
Terminal strength	AEC-Q200-006

## Solder Reflow and Rework Recommendations

Profile Feature	Pb-Free Assembly
Average Ramp-Up Rate (T <sub>smax</sub> to T <sub>p</sub> )	3°C/second max
Preheat :	
Temperature Min (T <sub>smin</sub> )	150°C
Temperature Max (T <sub>smax</sub> )	200°C
Time (t <sub>smin</sub> to t <sub>smax</sub> )	60-180 seconds
Time maintained above:	
Temperature(T <sub>L</sub> )	217°C
Time (t <sub>L</sub> )	60-150 seconds
Peak/Classification Temperature(T <sub>p</sub> ) :	260°C
Time within 5°C of actual Peak :	
Temperature (t <sub>p</sub> )	20-40 seconds
Ramp-Down Rate :	6°C/second max.
Time 25°C to Peak Temperature :	8 minutes max

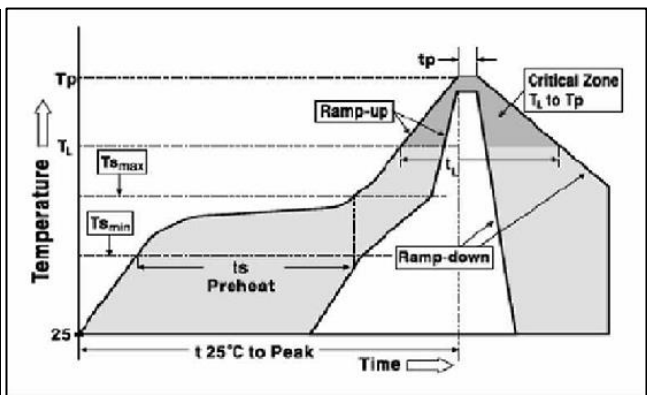

### Solder Reflow

Due to "lead free / RoHS 2" construction of these PTC devices, the required Temperature and Dwell Time in the "Soldering" zone of the reflow profile are greater than those used for non-RoHS devices.

1. Recommended reflow methods; IR, vapor phase oven, hot air oven.
2. Not Recommended For Wave Solder / Direct Immersion.
3. Recommended paste thickness range – 0.20 – 0.25mm.
4. Devices are compatible with standard industry cleaning solvents and methods.
5. MSL: 2a (According to IPC J-Std-020).

### Caution

If reflow temperature / dwell times exceed the recommended profile, the electrical performance of the PTC may be affected.

Rework: MIL-STD-202G Method 210F, Test Condition A.

## Standard Packaging

Part Number	Tape/Reel Qty
0ZCK0010FF2G Thru 0ZCK0035FF2G	4,000
0ZCK0050FF2E Thru 0ZCK0110FF2E	3,000

4000 or 3000 fuses in 7 inches dia. Reel, 8mm wide tape, 4mm pitch, per EIA-481 (equivalent IEC-286 part 3).

## P/N Explanation and Ordering Information

	0ZCK	0XXX	X	X	XX
PTC series	_____				
0ZCK,0805 Size	_____				
I HOLD Rating	_____				
Refer to Part Number and IH Rating in Electrical Characteristics Table on P.1.					
Electrical Characteristics	_____				
F = Standard Design					
A to Z (except F) = Special, customer spec, DCR sort, etc.					
Mechanical Features	_____				
F = Standard Design					
A to Z (except F) = Special, customer spec, lead forming, etc.					
Tape & Reel Qty	_____				
See standard packaging					

Specifications subject to change without notice



Bel Fuse Inc.  
206 Van Vorst Street  
Jersey City, NJ 07302 USA

+1 201.432.0463  
Bel.US.CS@belf.com  
[belfuse.com/circuit-protection](http://belfuse.com/circuit-protection)

# Mouser Electronics

Authorized Distributor

Click to View Pricing, Inventory, Delivery & Lifecycle Information:

Bel:

[0ZCK0050FF2E](#) [0ZCK0020FF2G](#) [0ZCK0010FF2G](#) [0ZCK0075FF2E](#) [0ZCK0100FF2E](#) [0ZCK0035FF2G](#)  
[0ZCK0050AF2E](#)