

SP-T2A-F

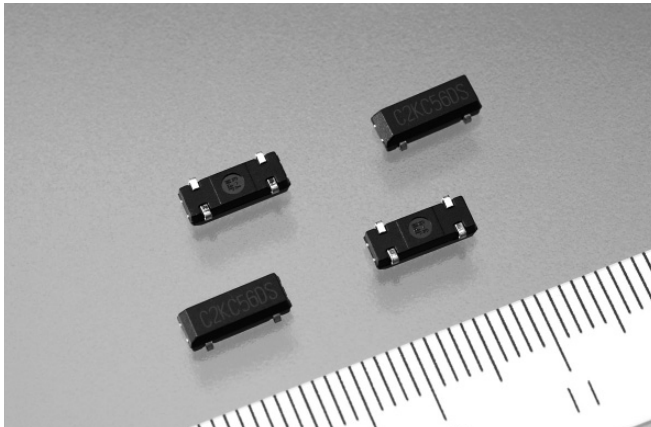

FEATURES

- Plastic mold package incorporated tubular type quartz crystal.
- Suitable for automatic and high density surface mounting.
- Excellent shock and heat resistance.
- RoHS directive compliant.

APPLICATIONS

Notebook Computers, Camcorders, Car Audio, LCD TV, Water/Electricity/Gas Meter, Security Devices, Payment Terminal, Portable Applications, Clock Source for Micro-Computers

STANDARD SPECIFICATIONS

Conditions without notice (Temperature: +25±2°C, DL: 0.1μW)

Item	Symbol	Specifications		Conditions / Notes
Nominal Frequency	f_nom	32.768kHz	32kHz to 200kHz*	
Frequency Tolerance	f_tol	±20 x 10 ⁻⁶ , ±50 x 10 ⁻⁶ , ±100 x 10 ⁻⁶		
Turnover Temperature	Ti	+25±5°C	+25±8°C	
Parabolic Coefficient	B	(-3.5±0.8) x 10 ⁻⁸ /°C ²		
Load Capacitance	CL	6.0 to 12.5pF		
Motional Resistance (ESR)	R1 typ./max.	34kΩ / 50kΩ		
Absolute Maximum Drive Level	DLmax	1μW		
Level of Drive	DL	0.1μW		
Shunt Capacitance	Co	1.0pF typ.	0.95pF typ.	
Frequency Ageing	f_age	±3 x 10 ⁻⁶		+25±3°C, First Year
Operating Temperature	T_use	-40°C to +85°C		
Storage Temperature	T_stg	-55°C to +125°C		Piece part basis

* Please feel free to contact us for inquiries about other frequencies in need.

DIMENSIONS

(For details, please refer to individual specification)

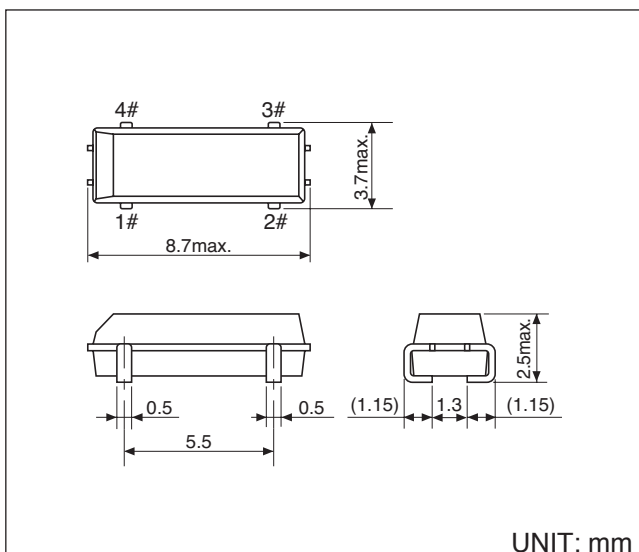

INTERNAL LEAD CONNECTION

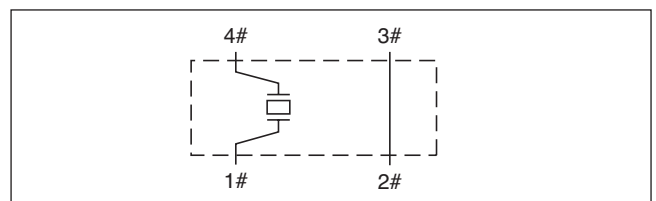

RECOMMENDED SOLDERING PATTERN

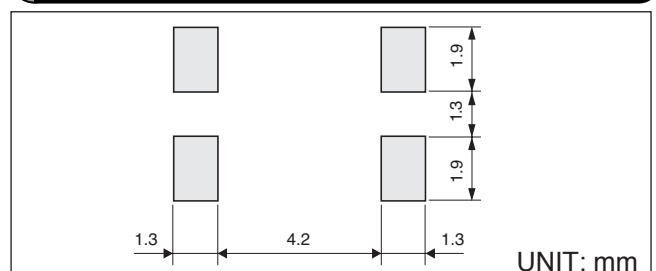

- Remarks**
1. Do not connect terminals #2, #3 to external device and GND. These are dummy terminals.
 2. The part of the cylinder inside resin mold may be sometimes exposed, however, it does not affect the characteristics of crystal unit.