

N-channel 650 V, 0.79 Ω typ., 5 A MDmesh M2 Power MOSFET in a TO-220FP ultra narrow leads package

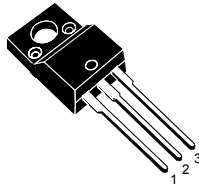

TO-220FP
ultra narrow leads

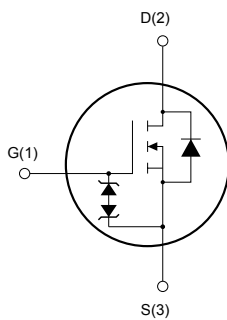

AM15572v1_no_tab



Product status link

[STFU9N65M2](#)

Product summary

Order code	STFU9N65M2
Marking	9N65M2
Package	TO-220FP ultra narrow leads
Packing	Tube

Features

Order code	V_{DS}	$R_{DS(on)}$ max.	I_D
STFU9N65M2	650 V	0.90 Ω	5 A

- Extremely low gate charge
- Excellent output capacitance (C_{OSS}) profile
- 100% avalanche tested
- Zener-protected

Applications

- Switching applications

Description

This device is an N-channel Power MOSFET developed using MDmesh M2 technology. Thanks to its strip layout and an improved vertical structure, the device exhibits low on-resistance and optimized switching characteristics, rendering it suitable for the most demanding high efficiency converters.

1 Electrical ratings

Table 1. Absolute maximum ratings

Symbol	Parameter	Value	Unit
V_{GS}	Gate-source voltage	± 25	V
$I_D^{(1)}$	Drain current (continuous) at $T_C = 25\text{ }^\circ\text{C}$	5	A
$I_D^{(1)}$	Drain current (continuous) at $T_C = 100\text{ }^\circ\text{C}$	3.2	A
$I_{DM}^{(2)}$	Drain current pulsed	20	A
P_{TOT}	Total power dissipation at $T_C = 25\text{ }^\circ\text{C}$	20	W
V_{ISO}	Insulation withstand voltage (RMS) from all three leads to external heat sink ($t = 1\text{ s}$; $T_C = 25\text{ }^\circ\text{C}$)	2.5	kV
$dv/dt^{(3)}$	Peak diode recovery voltage slope	15	V/ns
$dv/dt^{(4)}$	MOSFET dv/dt ruggedness	50	
T_J	Operating junction temperature range	-55 to 150	$^\circ\text{C}$
T_{stg}	Storage temperature range		

1. Current limited by package.
2. Pulse width limited by safe operating area.
3. $I_{SD} \leq 5\text{ A}$, $di/dt \leq 400\text{ A}/\mu\text{s}$, $V_{DS(peak)} \leq V_{(BR)DSS}$, $V_{DD} = 400\text{ V}$.
4. $V_{DS} \leq 520\text{ V}$.

Table 2. Thermal data

Symbol	Parameter	Value	Unit
$R_{thj-case}$	Thermal resistance junction-case	6.25	$^\circ\text{C}/\text{W}$
$R_{thj-amb}$	Thermal resistance junction-ambient	62.5	$^\circ\text{C}/\text{W}$

Table 3. Avalanche characteristics

Symbol	Parameter	Value	Unit
I_{AR}	Avalanche current, repetitive or not repetitive (pulse width limited by T_J max)	1	A
E_{AS}	Single pulse avalanche energy (starting $T_J = 25\text{ }^\circ\text{C}$, $I_D = I_{AR}$, $V_{DD} = 50\text{ V}$)	105	mJ

2 Electrical characteristics

($T_C = 25\text{ °C}$ unless otherwise specified)

Table 4. On/off states

Symbol	Parameter	Test conditions	Min.	Typ.	Max.	Unit
$V_{(BR)DSS}$	Drain-source breakdown voltage	$V_{GS} = 0\text{ V}$, $I_D = 1\text{ mA}$	650			V
I_{DSS}	Zero gate voltage drain current	$V_{GS} = 0\text{ V}$, $V_{DS} = 650\text{ V}$			1	μA
		$V_{GS} = 0\text{ V}$, $V_{DS} = 650\text{ V}$, $T_C = 125\text{ °C}^{(1)}$			100	μA
I_{GSS}	Gate-body leakage current	$V_{DS} = 0\text{ V}$, $V_{GS} = \pm 25\text{ V}$			± 10	μA
$V_{GS(th)}$	Gate threshold voltage	$V_{DS} = V_{GS}$, $I_D = 250\text{ }\mu\text{A}$	2	3	4	V
$R_{DS(on)}$	Static drain-source on-resistance	$V_{GS} = 10\text{ V}$, $I_D = 2.5\text{ A}$		0.79	0.90	Ω

1. Defined by design, not subject to production test.

Table 5. Dynamic

Symbol	Parameter	Test conditions	Min.	Typ.	Max.	Unit
C_{iss}	Input capacitance	$V_{DS} = 100\text{ V}$, $f = 1\text{ MHz}$, $V_{GS} = 0\text{ V}$	-	310	-	pF
C_{oss}	Output capacitance		-	18	-	pF
C_{rss}	Reverse transfer capacitance		-	0.9	-	pF
$C_{oss\text{ eq.}}^{(1)}$	Equivalent capacitance energy related	$V_{DS} = 0\text{ to }520\text{ V}$, $V_{GS} = 0\text{ V}$	-	109	-	pF
R_g	Intrinsic gate resistance	$f = 1\text{ MHz}$ open drain	-	6.6	-	Ω
Q_g	Total gate charge	$V_{DD} = 520\text{ V}$, $I_D = 5\text{ A}$	-	10.3	-	nC
Q_{gs}	Gate-source charge	$V_{GS} = 0\text{ to }10\text{ V}$	-	2.4	-	nC
Q_{gd}	Gate-drain charge	(see Figure 14. Test circuit for gate charge behavior)	-	4.8	-	nC

1. $C_{oss\text{ eq.}}$ is defined as a constant equivalent capacitance giving the same charging time as C_{oss} when V_{DS} increases from 0 to 80% V_{DSS} .

Table 6. Switching times

Symbol	Parameter	Test conditions	Min.	Typ.	Max.	Unit
$t_{d(on)}$	Turn-on delay time	$V_{DD} = 325\text{ V}$, $I_D = 2.5\text{ A}$,	-	7.5	-	ns
t_r	Rise time	$R_G = 4.7\text{ }\Omega$, $V_{GS} = 10\text{ V}$	-	6.6	-	ns
$t_{d(off)}$	Turn-off delay time	(see Figure 13. Test circuit for resistive load switching times and	-	22.5	-	ns
t_f	Fall time	Figure 18. Switching time waveform)	-	18	-	ns

Table 7. Source-drain diode

Symbol	Parameter	Test conditions	Min.	Typ.	Max.	Unit
I_{SD}	Source-drain current		-		5	A
$I_{SDM}^{(1)}$	Source-drain current (pulsed)		-		20	A
$V_{SD}^{(2)}$	Forward on voltage	$I_{SD} = 5\text{ A}$, $V_{GS} = 0\text{ V}$	-		1.6	V
t_{rr}	Reverse recovery time	$I_{SD} = 5\text{ A}$, $V_{DD} = 60\text{ V}$	-	276		ns
Q_{rr}	Reverse recovery charge	$di/dt = 100\text{ A}/\mu\text{s}$	-	1.7		μC
I_{RRM}	Reverse recovery current	(see Figure 15. Test circuit for inductive load switching and diode recovery times)	-	12.5		A
t_{rr}	Reverse recovery time	$I_{SD} = 5\text{ A}$, $V_{DD} = 60\text{ V}$	-	312		ns
Q_{rr}	Reverse recovery charge	$di/dt = 100\text{ A}/\mu\text{s}$,	-	1.9		μC
I_{RRM}	Reverse recovery current	$T_J = 150\text{ }^\circ\text{C}$ (see Figure 15. Test circuit for inductive load switching and diode recovery times)	-	12.4		A

1. Pulse width limited by safe operating area.

2. Pulsed: pulse duration = 300 μs , duty cycle 1.5 %.

2.1 Electrical characteristics (curves)

Figure 1. Safe operating area

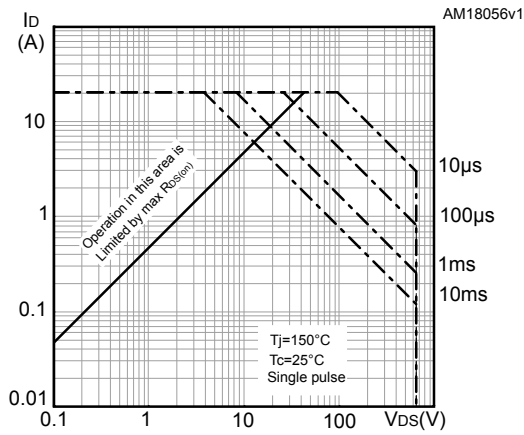

Figure 2. Thermal Impedance

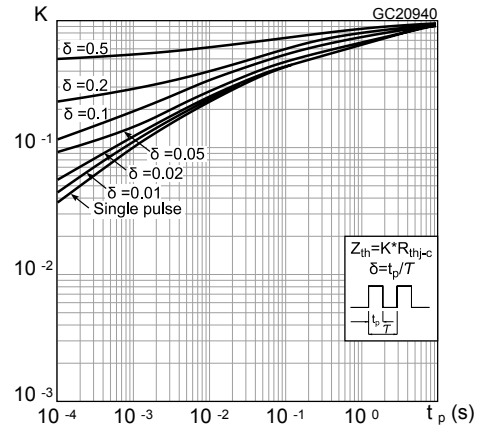

Figure 3. Output characteristics

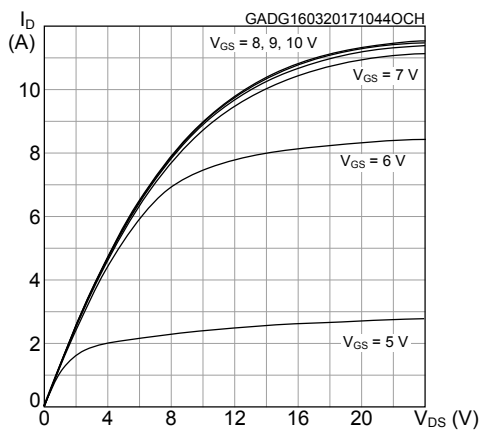

Figure 4. Transfer characteristics

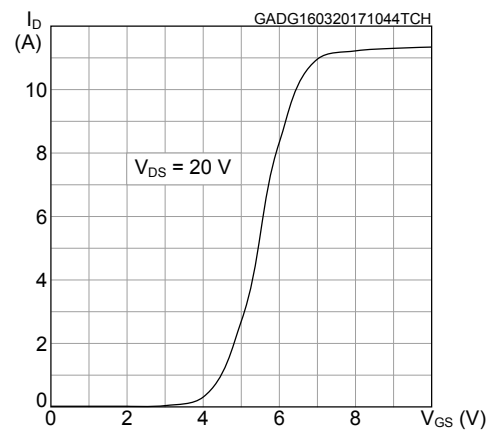

Figure 5. Gate charge vs gate-source voltage

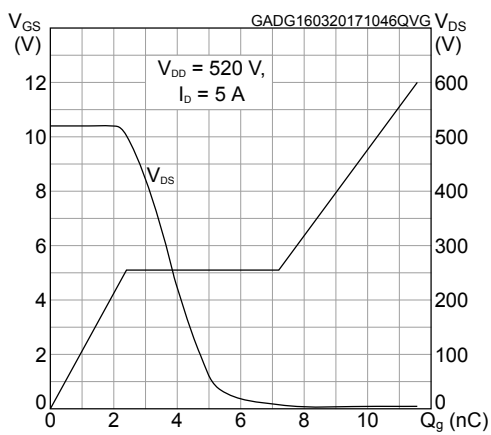

Figure 6. Static drain-source on-resistance

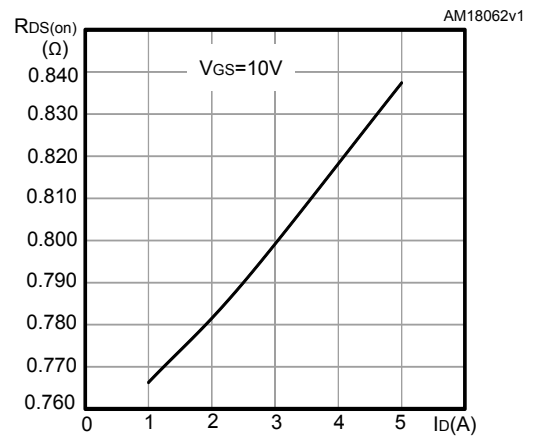

Figure 7. Capacitance variations

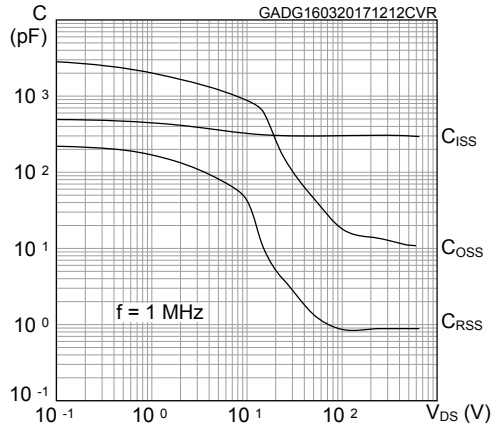

Figure 8. Output capacitance stored energy

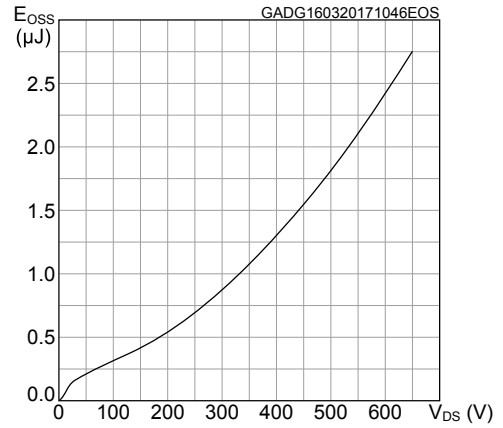

Figure 9. Normalized gate threshold voltage vs temperature

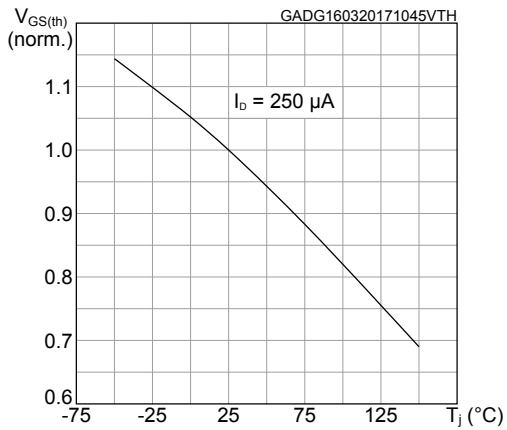

Figure 10. Normalized on-resistance vs temperature

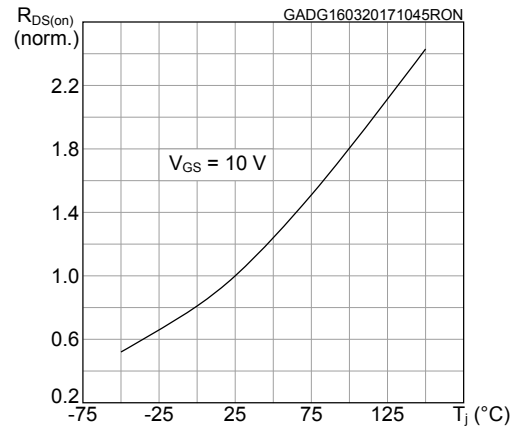

Figure 11. Normalized $V_{(BR)DSS}$ vs temperature

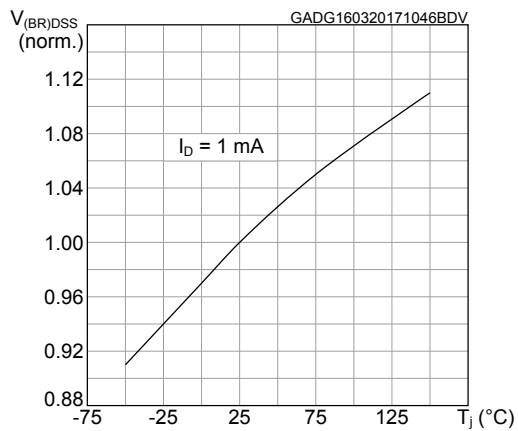
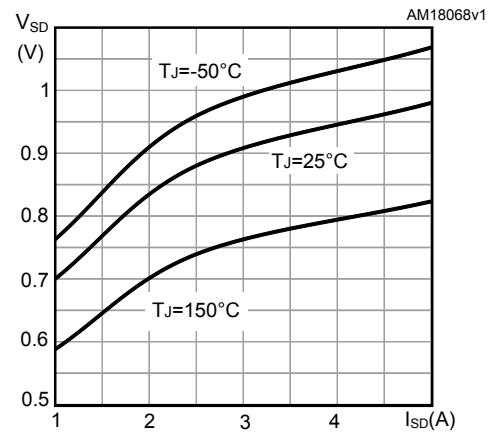
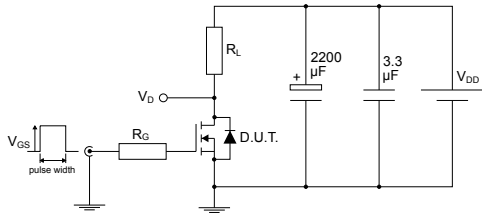

Figure 12. Source-drain diode forward characteristics



3 Test circuits

Figure 13. Test circuit for resistive load switching times

AM01468v1

Figure 14. Test circuit for gate charge behavior

AM01469v1

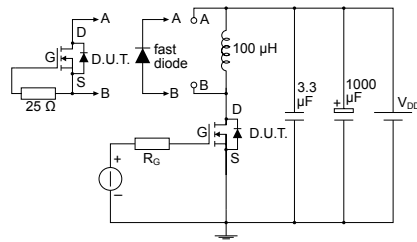
Figure 15. Test circuit for inductive load switching and diode recovery times

AM01470v1

Figure 16. Unclamped inductive load test circuit

AM01471v1

Figure 17. Unclamped inductive waveform

AM01472v1

Figure 18. Switching time waveform



AM01473v1

4 Package information

In order to meet environmental requirements, ST offers these devices in different grades of **ECOPACK** packages, depending on their level of environmental compliance. ECOPACK specifications, grade definitions and product status are available at: www.st.com. ECOPACK is an ST trademark.

4.1 TO-220FP ultra narrow leads package information

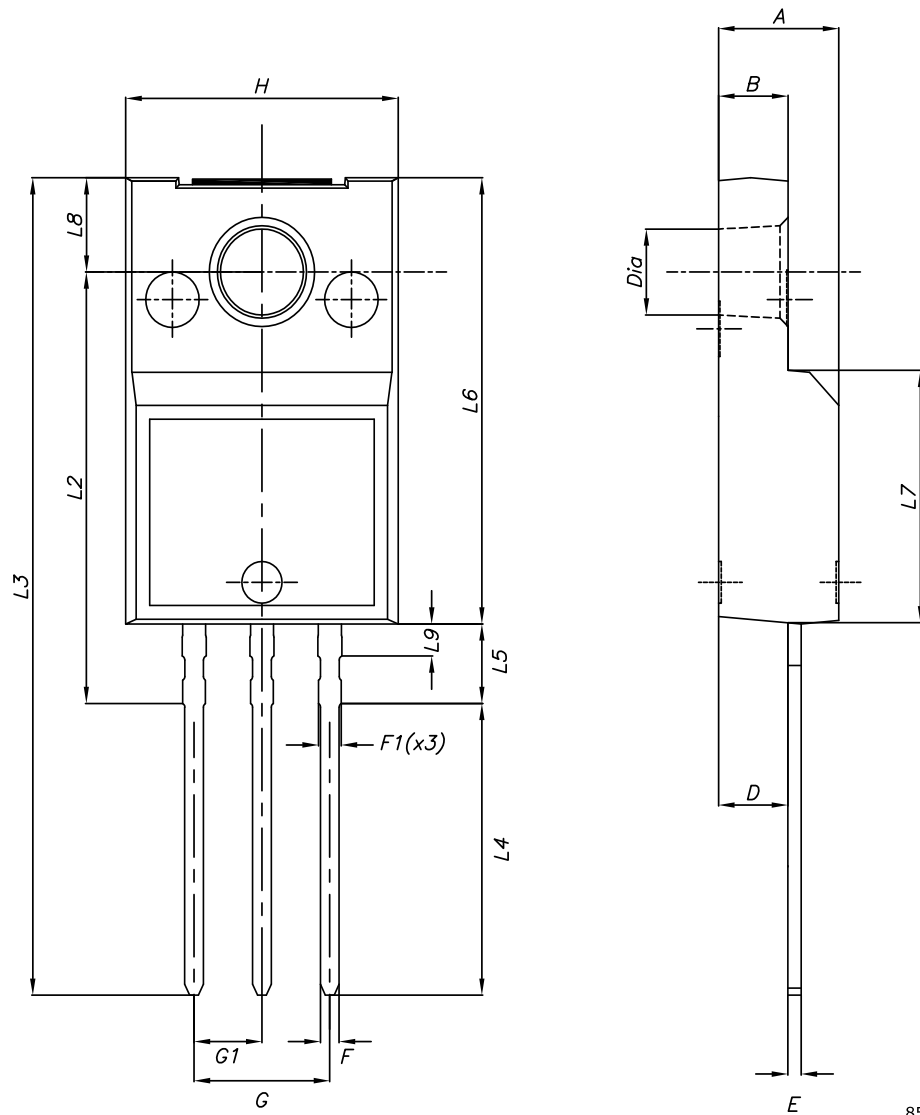
Figure 19. TO-220FP ultra narrow leads package outline



8576148_2

Table 8. TO-220FP ultra narrow leads mechanical data

Dim.	mm		
	Min.	Typ.	Max.
A	4.40		4.60
B	2.50		2.70
D	2.50		2.75
E	0.45		0.60
F	0.65		0.75
F1	-		0.90
G	4.95		5.20
G1	2.40	2.54	2.70
H	10.00		10.40
L2	15.10		15.90
L3	28.50		30.50
L4	10.20		11.00
L5	2.50		3.10
L6	15.60		16.40
L7	9.00		9.30
L8	3.20		3.60
L9	-		1.30
Dia.	3.00		3.20

Revision history

Table 9. Document revision history

Date	Revision	Changes
04-Aug-2016	1	First release.
08-Sep-2016	2	Document status updated from preliminary to production data.
21-Jun-2019	3	Updated Table 1. Absolute maximum ratings and Table 5. Dynamic . Updated Section 2.1 Electrical characteristics (curves) . Minor text changes.

Contents

1	Electrical ratings	2
2	Electrical characteristics	3
2.1	Electrical characteristics (curves)	5
3	Test circuits	7
4	Package information	8
4.1	TO-220FP ultra narrow leads package information	8
	Revision history	10

IMPORTANT NOTICE – PLEASE READ CAREFULLY

STMicroelectronics NV and its subsidiaries (“ST”) reserve the right to make changes, corrections, enhancements, modifications, and improvements to ST products and/or to this document at any time without notice. Purchasers should obtain the latest relevant information on ST products before placing orders. ST products are sold pursuant to ST’s terms and conditions of sale in place at the time of order acknowledgement.

Purchasers are solely responsible for the choice, selection, and use of ST products and ST assumes no liability for application assistance or the design of Purchasers’ products.

No license, express or implied, to any intellectual property right is granted by ST herein.

Resale of ST products with provisions different from the information set forth herein shall void any warranty granted by ST for such product.

ST and the ST logo are trademarks of ST. For additional information about ST trademarks, please refer to www.st.com/trademarks. All other product or service names are the property of their respective owners.

Information in this document supersedes and replaces information previously supplied in any prior versions of this document.

© 2019 STMicroelectronics – All rights reserved

Mouser Electronics

Authorized Distributor

Click to View Pricing, Inventory, Delivery & Lifecycle Information:

[STMicroelectronics:](#)

[STFU9N65M2](#)