

Description: 1.575 GHz GNSS Ceramic Chip Antenna

Series: Ceramic Chip Antenna

PART NUMBER: W3011A



Features:

- Frequency 1559-1606.6MHz
- Gain 1.3 / 2.0 / 2.2dBi
- Size 3.2 x 1.6 x 1.1 mm
- PCB Keep out 4 x 6.25 mm
- Polarization Linear
- Radiation pattern Omni

Applications:

- L1 GNSS Receivers
- Beidou, GPS, Galileo Glonass
- IoT, M2M
- Asset tracking
- Portable satellite receivers

All dimensions are in mm / inches

Issue: 2019

In the effort to improve our products, we reserve the right to make changes judged to be necessary.

CONFIDENTIAL AND PROPRIETARY INFORMATION

This document contains confidential and proprietary information of Pulse Electronics, Inc. (Pulse) and is protected by copyright, trade secret and other state and federal laws. Its receipt or possession does not convey any rights to reproduce, disclose its contents, or to manufacture, use or sell anything it may describe. Reproduction, disclosure or use without specific written authorization of Pulse is strictly forbidden.

For more information:

Pulse Worldwide Headquarters
15255 Innovation Drive #100
San Diego, CA 92128
USA
Tel: 1-858-674-8100

Pulse/Larsen Antennas
18110 SE 34th St Bldg 2 Suite 250
Vancouver, WA 98683
USA
Tel: 1-360-944-7551

Europe Headquarters
Pulse GmbH & Do, KG
Zeppelinstrasse 15
Herrenberg, Germany
Tel: 49 7032 7806 0

Pulse (Suzhou) Wireless Products Co, Inc.
99 Huo Ju Road(#29 Bldg,4th Phase
Suzhou New District
Jiangsu Province, Suzhou 215009 PR China
Tel: 86 512 6807 9998



Description: 1.575 GHz GNSS Ceramic
 Chip Antenna

Series: Ceramic Chip Antenna

PART NUMBER: W3011A

ELECTRICAL SPECIFICATIONS

Antenna Type	Chip antenna
Frequency	1559-1563MHz 1574.4-1576.4MHz 1598.6-1606.6MHz
Nominal Impedance	50 Ω
Return Loss (Max)	-7 / -10 / -10 dB
Radiation Pattern	Omni
Gain(Min)	1.3 / 2.0 / 2.2dBi
Efficiency(Min)	65 / 75 / 78 %
Polarization	Vertical
Power Withstanding	2W

MECHANICAL SPECIFICATIONS

Compact size	3.2 x 1.6 x 1.1mm
Weight	0.033g
Fixing system	SMT
MSL(MOISTURE SENSITIVITY LEVEL)	1

ENVIRONMENTAL SPECIFICATIONS

Operating Temperature	-40 ~ +85° C
Storage Temperature	-40 ~ +85° C
RoHS Compliant	Yes

Issue: 2019

In the effort to improve our products, we reserve the right to make changes judged to be necessary.

CONFIDENTIAL AND PROPRIETARY INFORMATION

This document contains confidential and proprietary information of Pulse Electronics, Inc. (Pulse) and is protected by copyright, trade secret and other state and federal laws. Its receipt or possession does not convey any rights to reproduce, disclose its contents, or to manufacture, use or sell anything it may describe. Reproduction, disclosure or use without specific written authorization of Pulse is strictly forbidden.

Description: 1.575 GHz GNSS Ceramic Chip Antenna

Series: Ceramic Chip Antenna

PART NUMBER: W3011A

MECHANICAL DRAWING

Ag metallization contact pad area (2x)

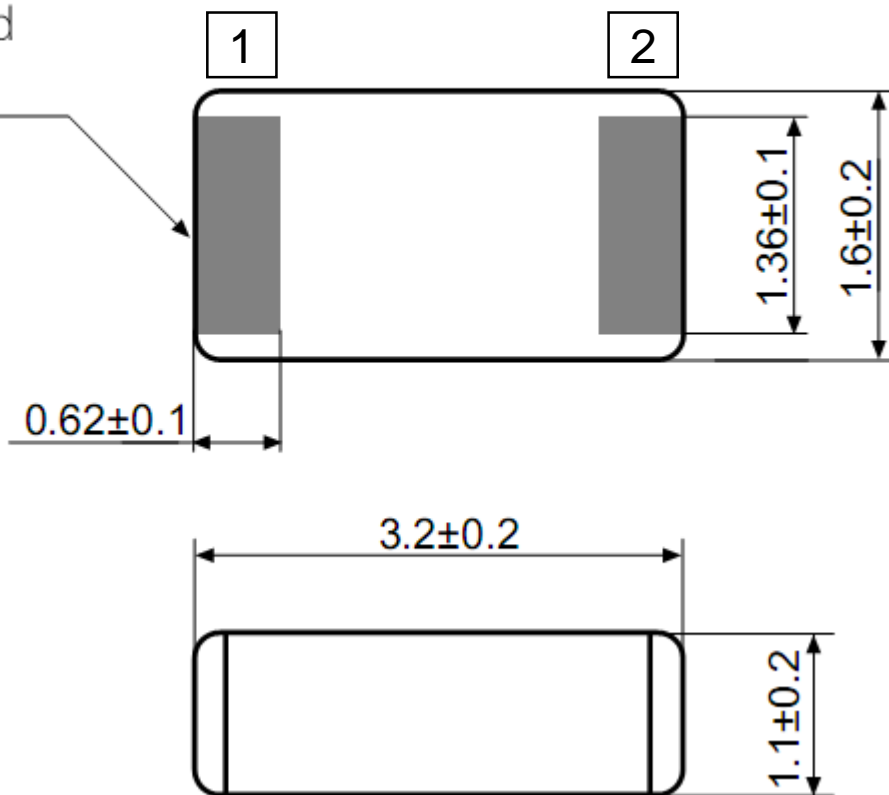

Antenna features

No.	Terminal name	Terminal Dimensions
1	Feed / GND	0.62 x 1.36 mm
2	Feed / GND	0.62 x 1.36 mm

Antenna is symmetrical.

Either of terminals 1 or 2 can be feed / GND

Issue: 2019

In the effort to improve our products, we reserve the right to make changes judged to be necessary.

CONFIDENTIAL AND PROPRIETARY INFORMATION

This document contains confidential and proprietary information of Pulse Electronics, Inc. (Pulse) and is protected by copyright, trade secret and other state and federal laws. Its receipt or possession does not convey any rights to reproduce, disclose its contents, or to manufacture, use or sell anything it may describe. Reproduction, disclosure or use without specific written authorization of Pulse is strictly forbidden.

Description: 1.575 GHz GNSS Ceramic
Chip Antenna

Series: Ceramic Chip Antenna

PART NUMBER: W3011A

W3011 GPS Antenna PWB Layout

Ground cleared under antenna, clearance area 4.00 x 6.25 mm
Matching and tuning component value and placement depend on
application and surrounding mechanics / materials.

Feed line should be designed to match 50 Ω characteristic
impedance, depending on PWB material and thickness.

Recommended test board layout for electrical characteristic
measurement, test board outline size 80 x 37 mm.

Issue: 2019

In the effort to improve our products, we reserve the right to make changes judged to be necessary.

CONFIDENTIAL AND PROPRIETARY INFORMATION

This document contains confidential and proprietary information of Pulse Electronics, Inc. (Pulse) and is protected by copyright, trade secret and other state and federal laws. Its receipt or possession does not convey any rights to reproduce, disclose its contents, or to manufacture, use or sell anything it may describe. Reproduction, disclosure or use without specific written authorization of Pulse is strictly forbidden.

Description: 1.575 GHz GNSS Ceramic Chip Antenna

Series: Ceramic Chip Antenna

PART NUMBER: W3011A

PWB layout for W3011A GPS Antenna

Note: All dimensions are in metric system.

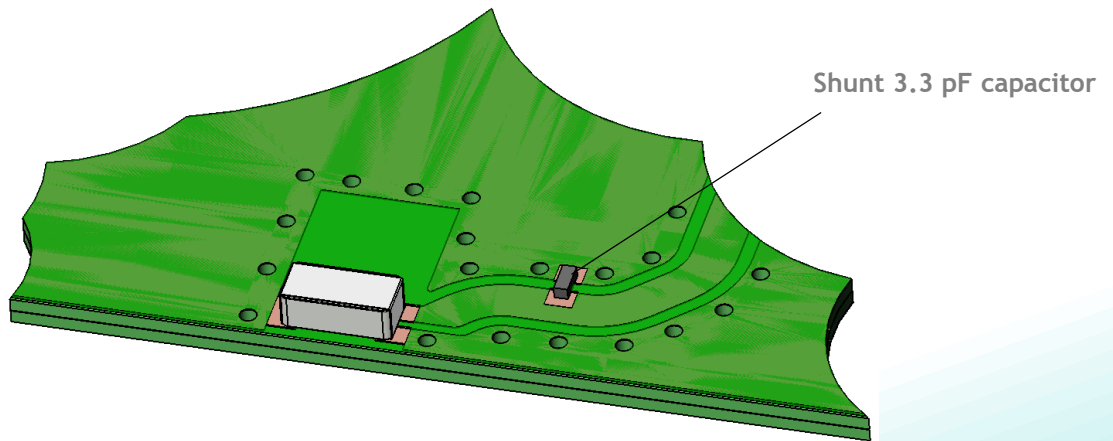
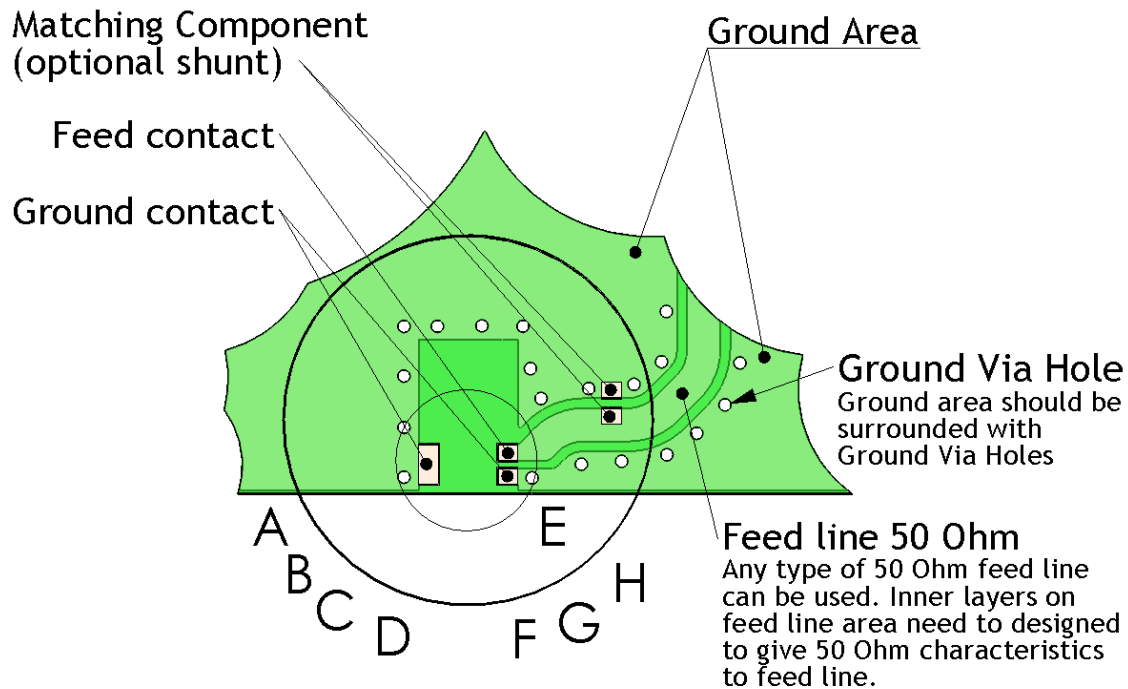

Issue: 2019

In the effort to improve our products, we reserve the right to make changes judged to be necessary.

CONFIDENTIAL AND PROPRIETARY INFORMATION

This document contains confidential and proprietary information of Pulse Electronics, Inc. (Pulse) and is protected by copyright, trade secret and other state and federal laws. Its receipt or possession does not convey any rights to reproduce, disclose its contents, or to manufacture, use or sell anything it may describe. Reproduction, disclosure or use without specific written authorization of Pulse is strictly forbidden.

Description: 1.575 GHz GNSS Ceramic Chip Antenna

Series: Ceramic Chip Antenna

PART NUMBER: W3011A

Ground clearance area for W3011A GPS Antenna

Ground clearance area (4,00 x 6,25 mm)

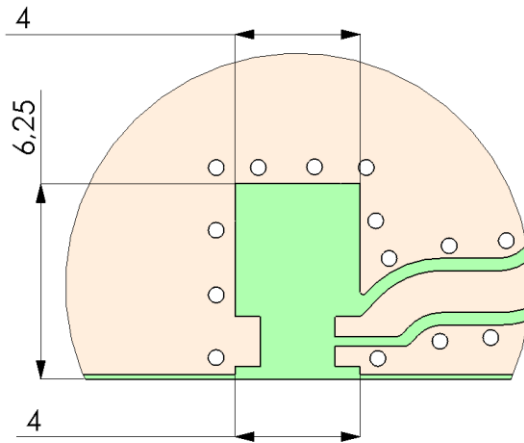

All metallization should be removed from all PWB layers on ground clearance area (4,00 x 6,25 mm).

DETAIL A

Opening in bottom/inner ground layers

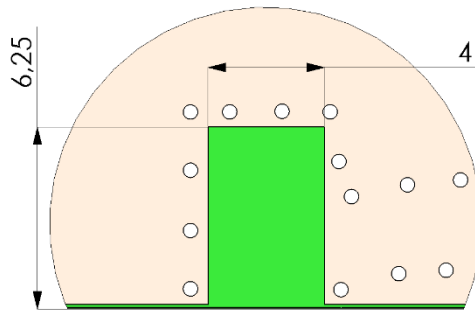

DETAIL B

Opening in other layers (no ground/ RF)

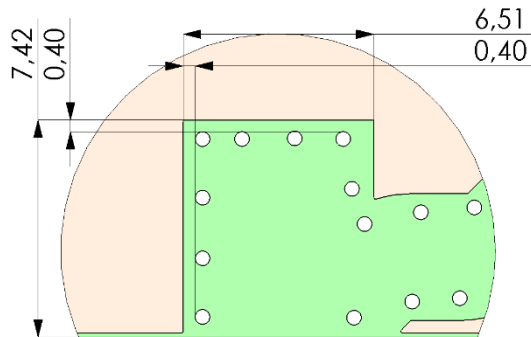

DETAIL C

Issue: 2019

In the effort to improve our products, we reserve the right to make changes judged to be necessary.

CONFIDENTIAL AND PROPRIETARY INFORMATION

This document contains confidential and proprietary information of Pulse Electronics, Inc. (Pulse) and is protected by copyright, trade secret and other state and federal laws. Its receipt or possession does not convey any rights to reproduce, disclose its contents, or to manufacture, use or sell anything it may describe. Reproduction, disclosure or use without specific written authorization of Pulse is strictly forbidden.

Description: 1.575 GHz GNSS Ceramic Chip Antenna

Series: Ceramic Chip Antenna

PART NUMBER: W3011A

PWB pad dimensions and antenna position for W3011A GPS Antenna

Pad dimensions in top copper

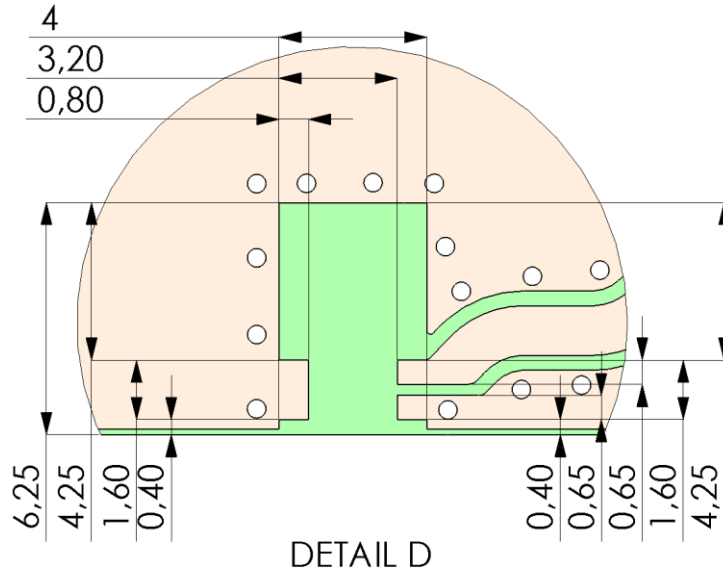

Antenna position on PWB layout

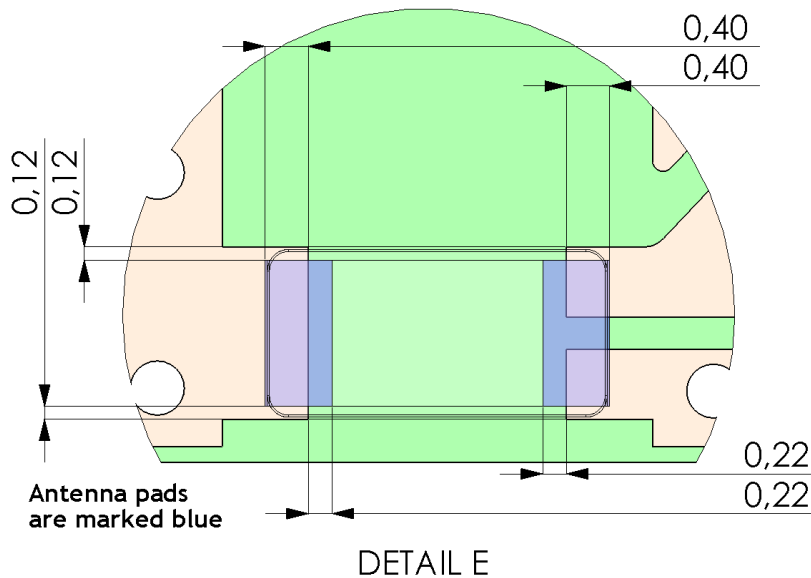

Issue: 2019

In the effort to improve our products, we reserve the right to make changes judged to be necessary.

CONFIDENTIAL AND PROPRIETARY INFORMATION

This document contains confidential and proprietary information of Pulse Electronics, Inc. (Pulse) and is protected by copyright, trade secret and other state and federal laws. Its receipt or possession does not convey any rights to reproduce, disclose its contents, or to manufacture, use or sell anything it may describe. Reproduction, disclosure or use without specific written authorization of Pulse is strictly forbidden.

Description: 1.575 GHz GNSS Ceramic Chip Antenna

Series: Ceramic Chip Antenna

PART NUMBER: W3011A

Typical Ground via hole placement in PWB layout for W3011A GPS Antenna

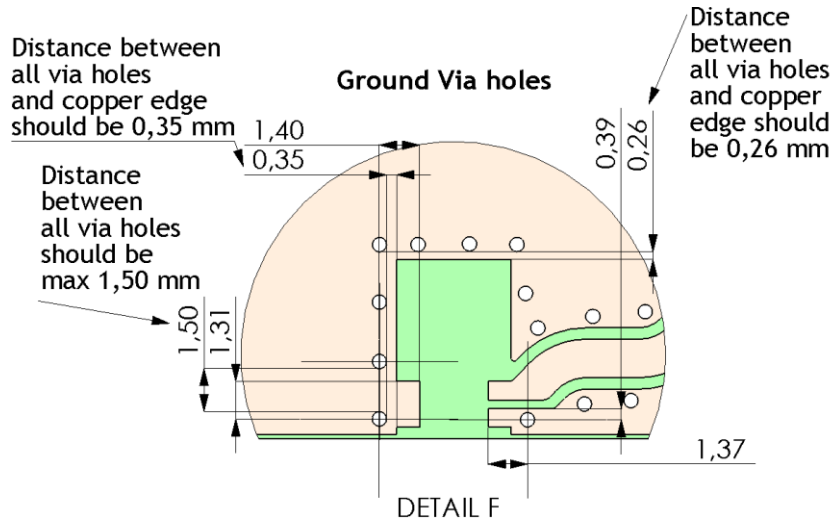

Solder resist opening and paste stencil recommendations for W3011A GPS Antenna

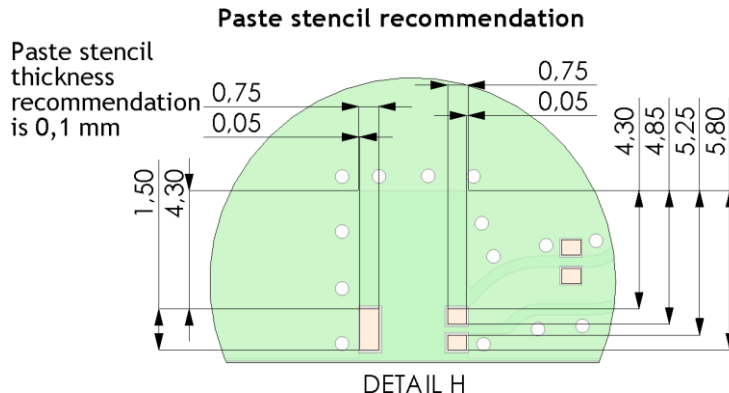
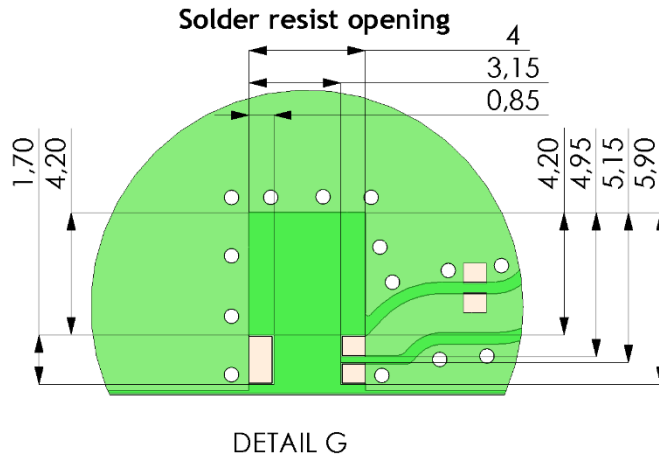

Issue: 2019

In the effort to improve our products, we reserve the right to make changes judged to be necessary.

CONFIDENTIAL AND PROPRIETARY INFORMATION

This document contains confidential and proprietary information of Pulse Electronics, Inc. (Pulse) and is protected by copyright, trade secret and other state and federal laws. Its receipt or possession does not convey any rights to reproduce, disclose its contents, or to manufacture, use or sell anything it may describe. Reproduction, disclosure or use without specific written authorization of Pulse is strictly forbidden.

Description: 1.575 GHz GNSS Ceramic
Chip Antenna

Series: Ceramic Chip Antenna

PART NUMBER: W3011A

TEST SETUP

All RF parameters tested on 80x37mm sized test board.
Antenna position on side center of PCB long edge.

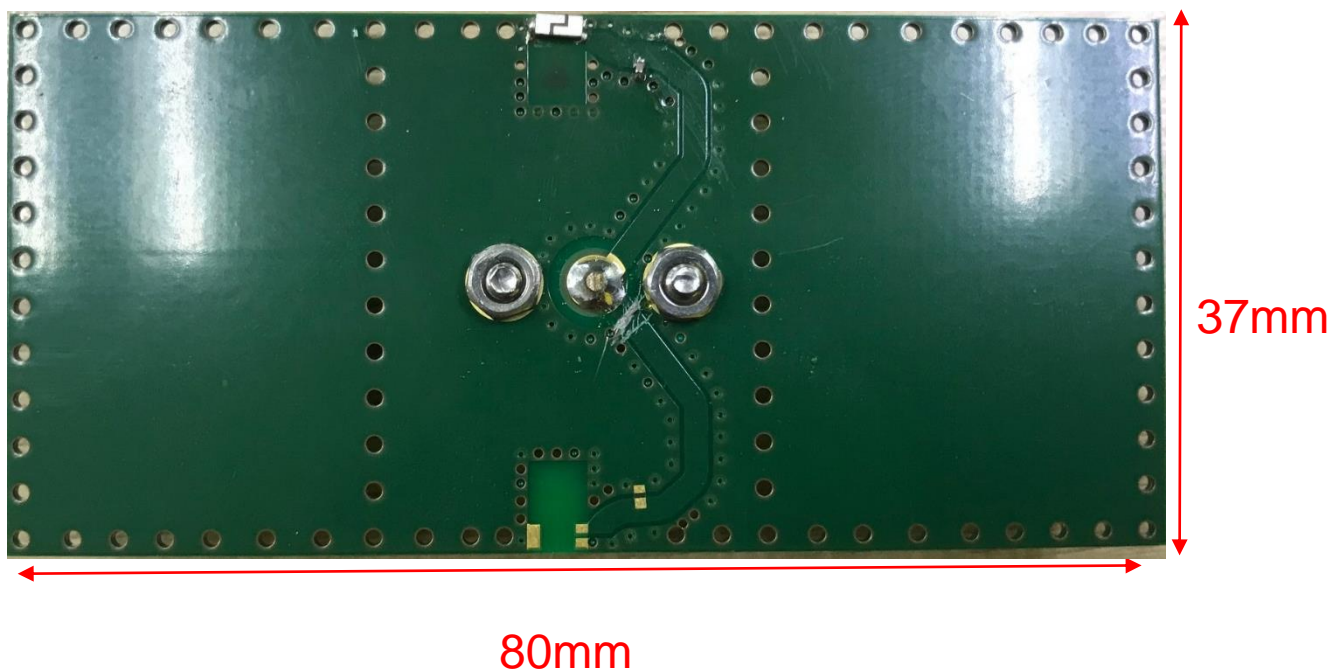

Issue: 2019

In the effort to improve our products, we reserve the right to make changes judged to be necessary.

CONFIDENTIAL AND PROPRIETARY INFORMATION

This document contains confidential and proprietary information of Pulse Electronics, Inc. (Pulse) and is protected by copyright, trade secret and other state and federal laws. Its receipt or possession does not convey any rights to reproduce, disclose its contents, or to manufacture, use or sell anything it may describe. Reproduction, disclosure or use without specific written authorization of Pulse is strictly forbidden.

Description: 1.575 GHz GNSS Ceramic Chip Antenna

Series: Ceramic Chip Antenna

PART NUMBER: W3011A

CHARTS

Return Loss vs Frequency

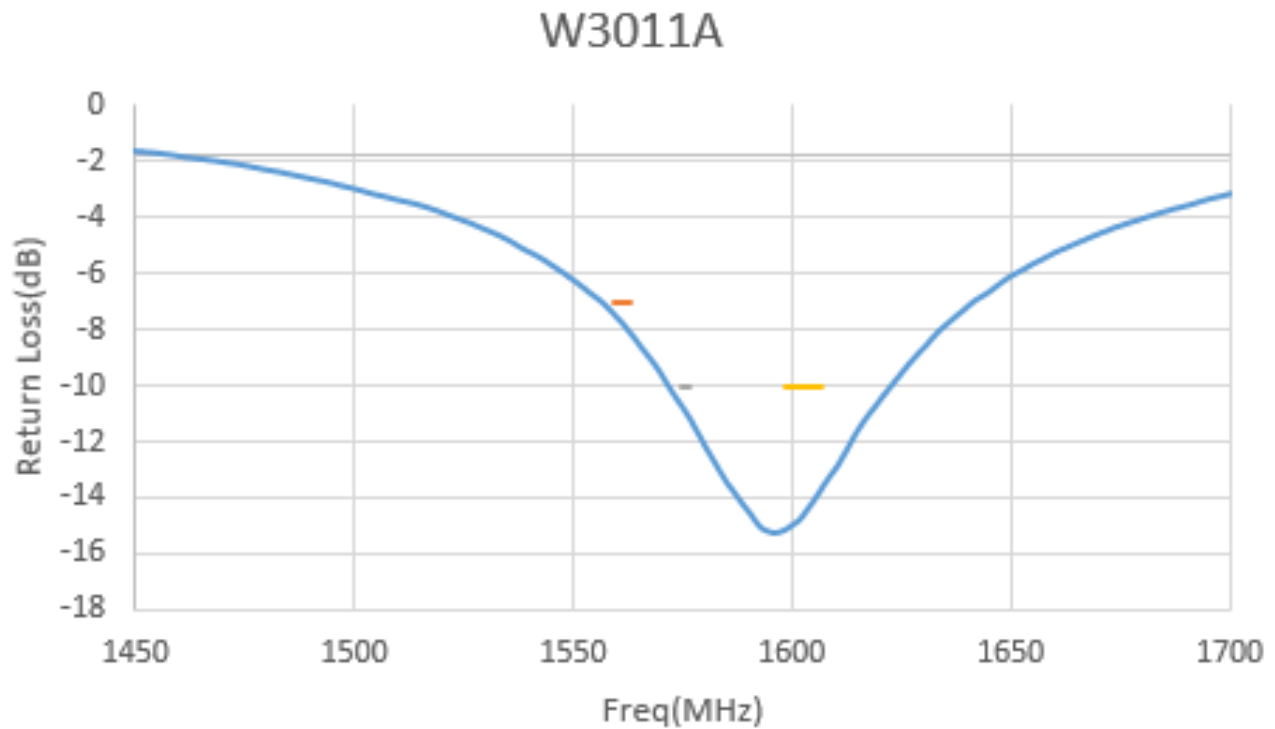

Issue: 2019

In the effort to improve our products, we reserve the right to make changes judged to be necessary.

CONFIDENTIAL AND PROPRIETARY INFORMATION

This document contains confidential and proprietary information of Pulse Electronics, Inc. (Pulse) and is protected by copyright, trade secret and other state and federal laws. Its receipt or possession does not convey any rights to reproduce, disclose its contents, or to manufacture, use or sell anything it may describe. Reproduction, disclosure or use without specific written authorization of Pulse is strictly forbidden.



Description: 1.575 GHz GNSS Ceramic Chip Antenna

Series: Ceramic Chip Antenna

PART NUMBER: W3011A

CHARTS

Gain vs Frequency

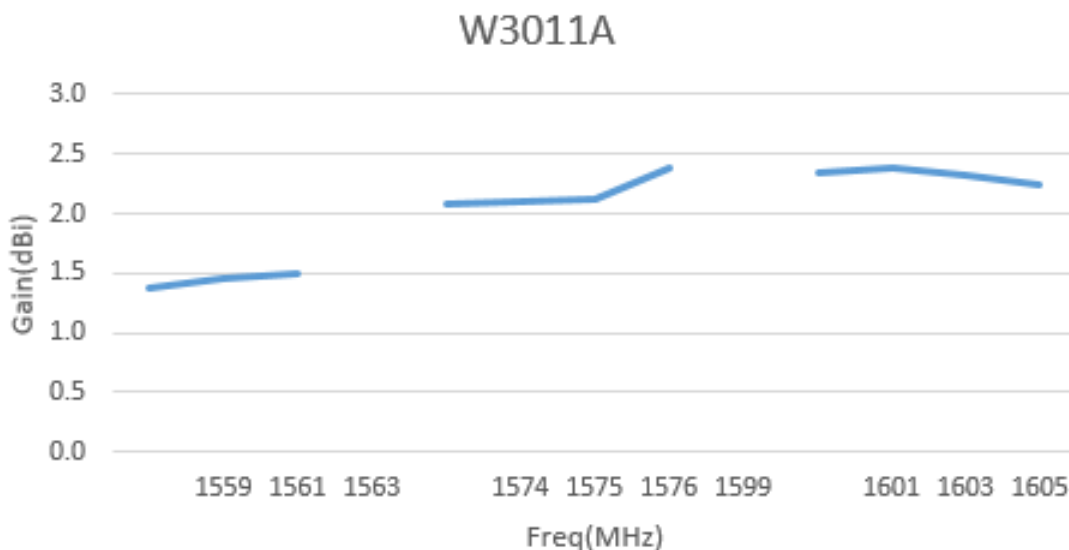

Radiation Efficiency vs Frequency

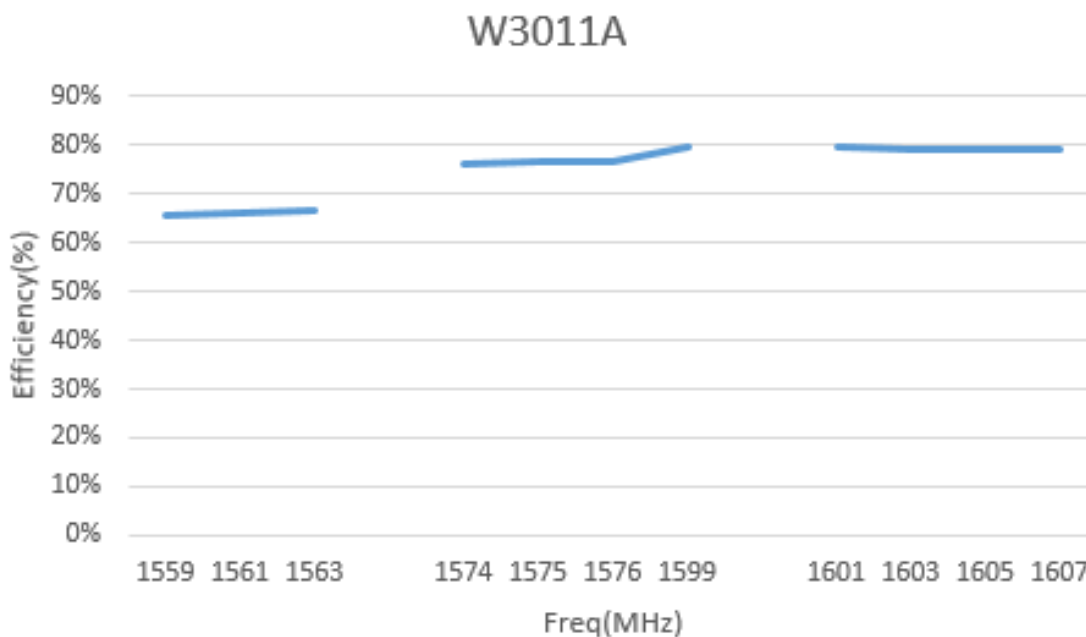

Issue: 2019

In the effort to improve our products, we reserve the right to make changes judged to be necessary.

CONFIDENTIAL AND PROPRIETARY INFORMATION

This document contains confidential and proprietary information of Pulse Electronics, Inc. (Pulse) and is protected by copyright, trade secret and other state and federal laws. Its receipt or possession does not convey any rights to reproduce, disclose its contents, or to manufacture, use or sell anything it may describe. Reproduction, disclosure or use without specific written authorization of Pulse is strictly forbidden.



Description: 1.575 GHz GNSS Ceramic Chip Antenna

Series: Ceramic Chip Antenna

PART NUMBER: W3011A

CHARTS

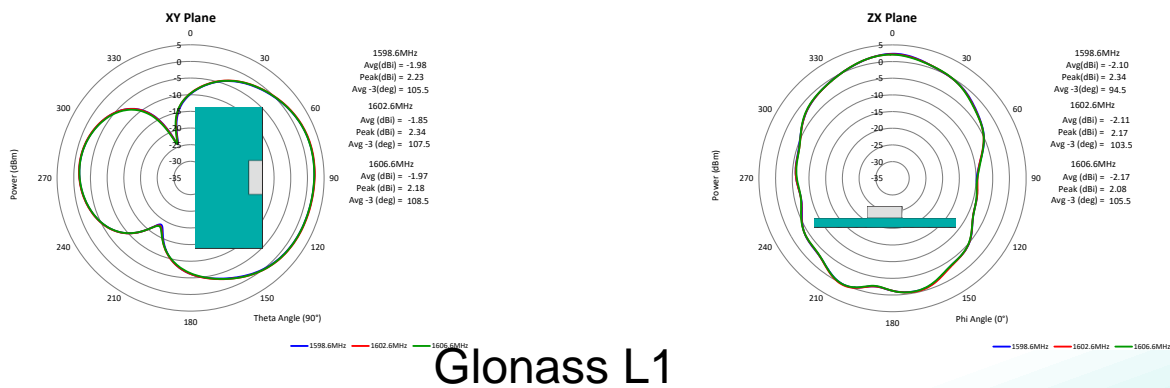
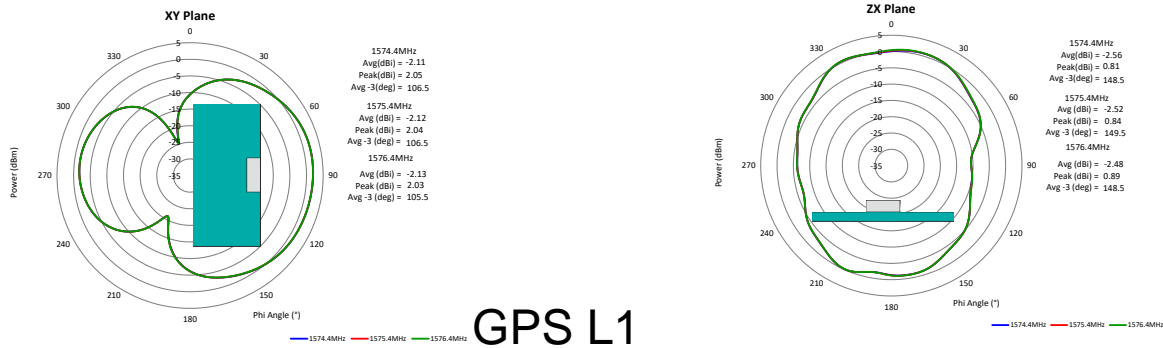
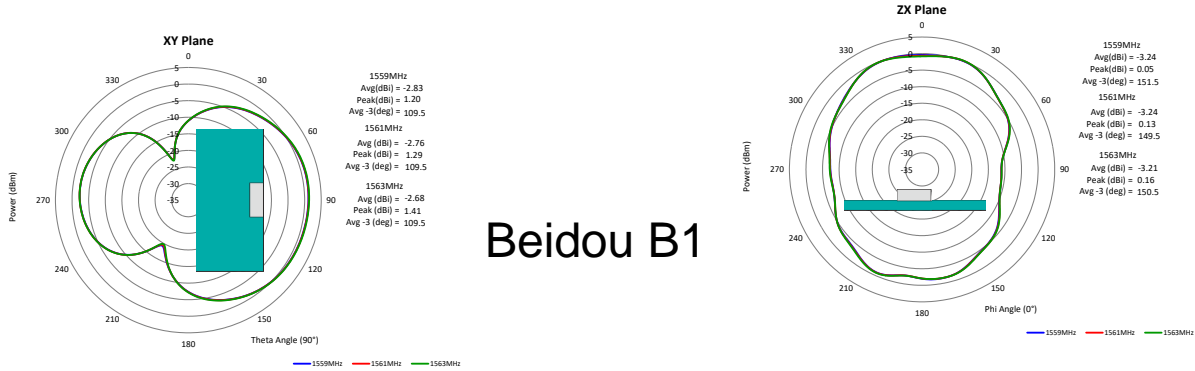

Issue: 2019

In the effort to improve our products, we reserve the right to make changes judged to be necessary.

CONFIDENTIAL AND PROPRIETARY INFORMATION

This document contains confidential and proprietary information of Pulse Electronics, Inc. (Pulse) and is protected by copyright, trade secret and other state and federal laws. Its receipt or possession does not convey any rights to reproduce, disclose its contents, or to manufacture, use or sell anything it may describe. Reproduction, disclosure or use without specific written authorization of Pulse is strictly forbidden.



Description: 1.575 GHz GNSS Ceramic Chip Antenna

Series: Ceramic Chip Antenna

PART NUMBER: W3011A

Recommendation for reflow soldering process

Printing stencil thickness 0,15 - 0,25 mm is recommended for the solder paste. The maximum soldering temperature should not exceed 260°C. The temperature profile recommendations for reflow soldering process is presented in the Figures 1 and 2. The reflow profile

presented in figure 1 describes minimum reflow temperatures. The reflow profile presented in figure 2 describes maximum reflow temperatures. located at the center of the coverage area.

	Method of heat transfer	Controlled hot air convection
1	Average temperature gradient in preheating	2.5 °C/s
2	Soak time	2-3 minutes
3	Max temperature gradient in reflow	3 °C/s
4	Time above 217 °C	Max 30 sec
5	Peak temperature in reflow	230 °C for 10 seconds
6	Temperature gradient in cooling	Max -5 °C/s

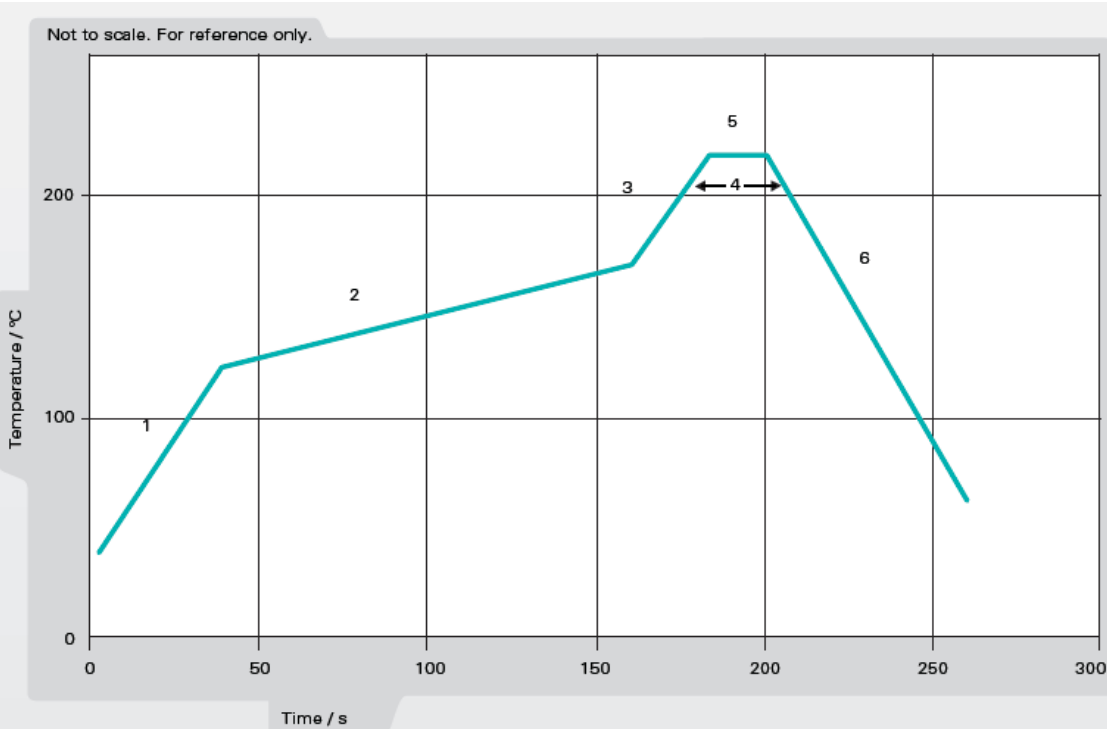

Figure 1. Minimum temperature profile recommendation for reflow soldering process

Issue: 2019

In the effort to improve our products, we reserve the right to make changes judged to be necessary.

CONFIDENTIAL AND PROPRIETARY INFORMATION

This document contains confidential and proprietary information of Pulse Electronics, Inc. (Pulse) and is protected by copyright, trade secret and other state and federal laws. Its receipt or possession does not convey any rights to reproduce, disclose its contents, or to manufacture, use or sell anything it may describe. Reproduction, disclosure or use without specific written authorization of Pulse is strictly forbidden.

Description: 1.575 GHz GNSS Ceramic Chip Antenna

Series: Ceramic Chip Antenna

PART NUMBER: W3011A

Recommendation for reflow soldering process

	Method of heat transfer	Controlled hot air convection
1	Average temperature gradient in preheating	2.5 °C/s
2	Soak time	2-3 minutes
3	Max temperature gradient in reflow	3 °C/s
4	Time above 217 °C	Max 60 sec
5	Time above 230 °C	Max 50 sec
6	Time above 250 °C	Max 10 sec
7	Peak temperature in reflow	260 °C for 5 seconds
8	Temperature gradient in cooling	Max -5 °C/s

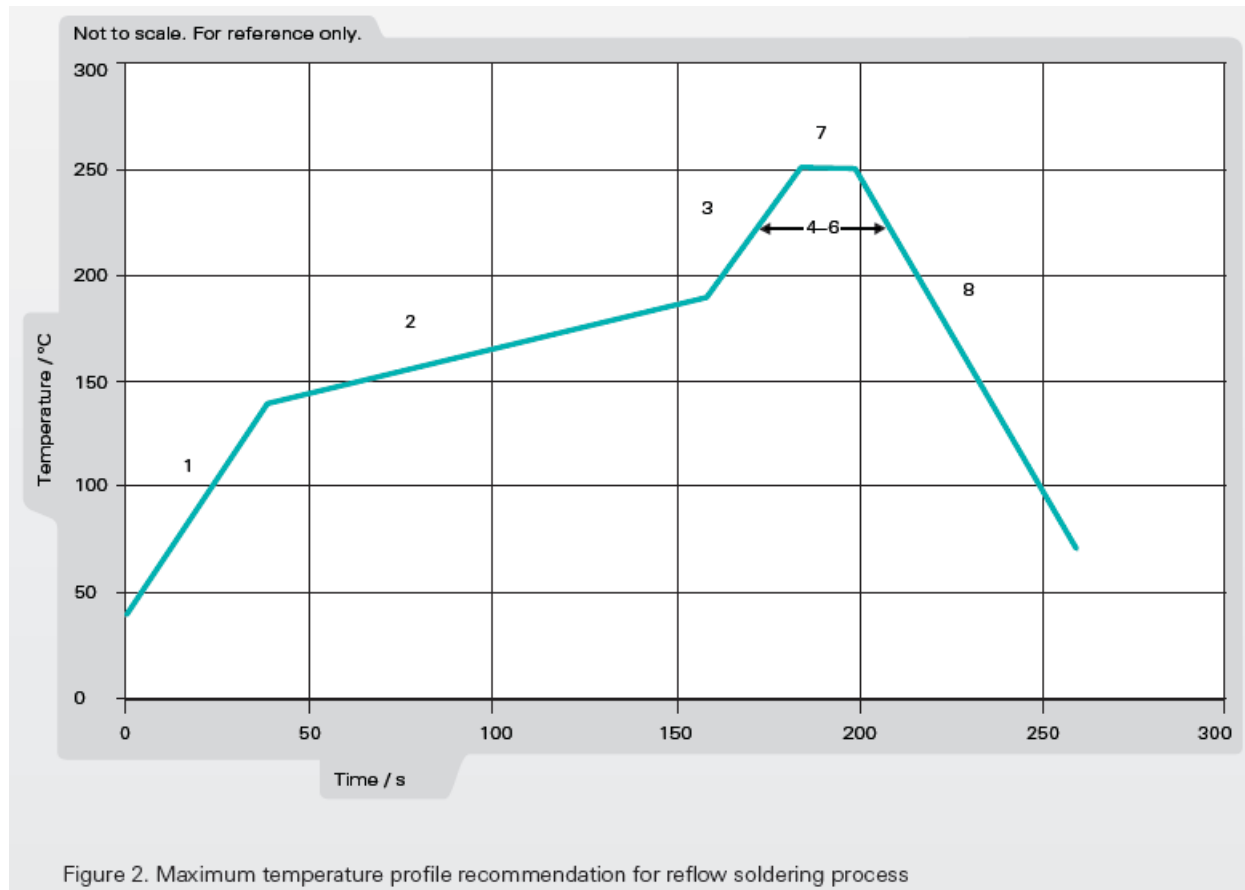

Issue: 2019

In the effort to improve our products, we reserve the right to make changes judged to be necessary.

CONFIDENTIAL AND PROPRIETARY INFORMATION

This document contains confidential and proprietary information of Pulse Electronics, Inc. (Pulse) and is protected by copyright, trade secret and other state and federal laws. Its receipt or possession does not convey any rights to reproduce, disclose its contents, or to manufacture, use or sell anything it may describe. Reproduction, disclosure or use without specific written authorization of Pulse is strictly forbidden.

Description: 1.575 GHz GNSS Ceramic Chip Antenna

Series: Ceramic Chip Antenna

PART NUMBER: W3011A

PACKAGING

Taping package
3000PCS/Reel
30000PCS/Carton box

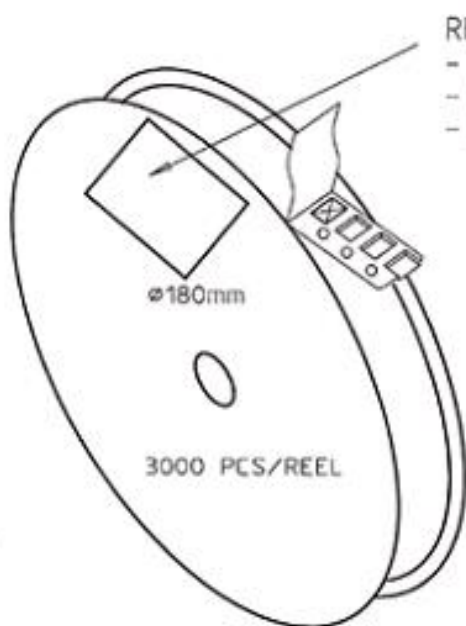

REEL LABEL INFORMATION:
- TRACEABILITY
- QUANTITY
- PRODUCT CODE

CARRIER TAPE H85-00125
width=8,00 depth=1,22
COVER TAPE H85-00126
width=5,60

LENGTH OF TAPE:

- Leader section: 50 empty cavities before component section
- Trailer section: 25 empty cavities after component section.

Empty part cavities at leader and trailer section of the tape must be sealed with top cover tape.

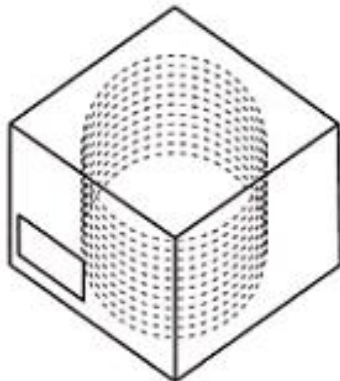

BOX H85-00128 (182x182x132)	1 pcs
- LABEL	1 pcs/BOX
REEL H85-00127 (D180, W12)	10 pcs
- REEL LABEL	1 pcs/REEL

Issue: 2019

In the effort to improve our products, we reserve the right to make changes judged to be necessary.

CONFIDENTIAL AND PROPRIETARY INFORMATION

This document contains confidential and proprietary information of Pulse Electronics, Inc. (Pulse) and is protected by copyright, trade secret and other state and federal laws. Its receipt or possession does not convey any rights to reproduce, disclose its contents, or to manufacture, use or sell anything it may describe. Reproduction, disclosure or use without specific written authorization of Pulse is strictly forbidden.

Description: 1.575 GHz GNSS Ceramic Chip Antenna

Series: Ceramic Chip Antenna

PART NUMBER: W3011A

PACKAGING

Tape size

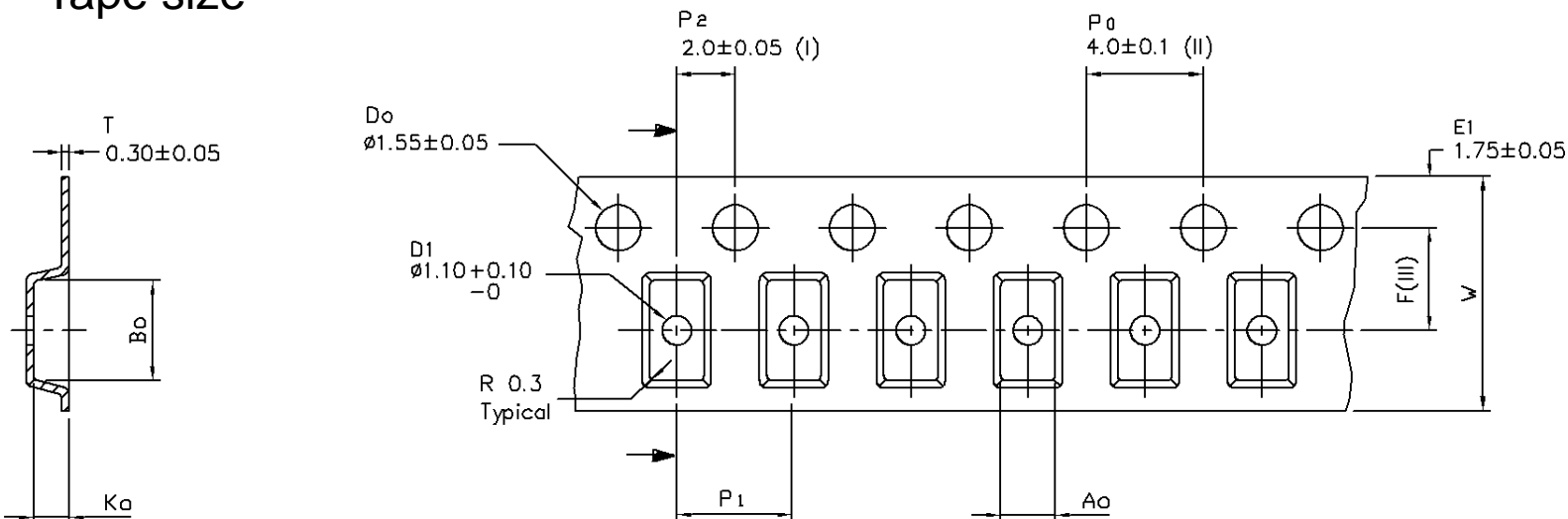

Ao	1.85	+ / - 0.1
Bo	3.43	+ / - 0.1
Ko	1.22	+ / - 0.1
F	3.50	+ / - 0.05
P1	4.00	+ / - 0.1
W	8.00	+ / - 0.1

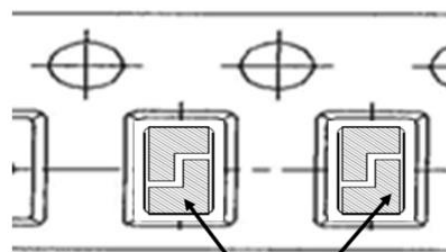

TOP SURFACE OF THE ANTENNA
(ANTENNA SOLDERING PADS
FACING DOWN TO THE BOTTOM
OF THE CARRIER TAPE)

TOP VIEW OF THE CARRIER TAPE

Issue: 2019

In the effort to improve our products, we reserve the right to make changes judged to be necessary.

CONFIDENTIAL AND PROPRIETARY INFORMATION

This document contains confidential and proprietary information of Pulse Electronics, Inc. (Pulse) and is protected by copyright, trade secret and other state and federal laws. Its receipt or possession does not convey any rights to reproduce, disclose its contents, or to manufacture, use or sell anything it may describe. Reproduction, disclosure or use without specific written authorization of Pulse is strictly forbidden.