

## FEATURES

- 300mA Buck Regulator, Drives Up to 10 LEDs per Channel with Fast NPN Current Sources
- Fast Current Sources for  $<1\mu\text{s}$  Pulse Widths (10,000:1 True Color PWM™ Dimming at 100Hz)
- LEDs Disconnected in Shutdown
- Adaptive  $V_{\text{OUT}}$  for Increased Efficiency
- 6V to 60V Input Voltage Range
- $\pm 1.5\%$  Accurate LED Current Matching
- External Resistors Set LED Current for Each Channel
- Requires No External Compensation
- Programmable Switching Frequency (200kHz to 1MHz)
- Synchronizable to External Clock
- Open, Short LED Detection and Reporting
- Programmable LED Thermal Derating and Reporting
- Programmable Temperature Protection
- 5mm  $\times$  8mm Thermally Enhanced QFN Package with 0.6mm High Voltage Pin Spacing

## APPLICATIONS

- LED Billboards and Signboards
- Mono, Multi, Full Color LED Displays
- Large Screen Display LED Backlighting
- Automotive, Industrial and Medical Displays

## DESCRIPTION

The LT<sup>®</sup>3596 is a 60V step-down LED Driver. It achieves 10,000:1 digital PWM dimming at 100Hz with fast NPN current sources driving up to 10 LEDs in each channel. 100:1 LED dimming can also be done with analog control of the CTRL1-3 pin.

The step-down switching frequency is programmable between 200kHz and 1MHz and is synchronizable to an external clock. The LT3596 also provides maximum LED brightness while adhering to manufacturers' specifications for thermal derating. The derate temperature is programmed by placing a negative temperature coefficient (NTC) resistor on the master control pin.

The LT3596 adaptively controls  $V_{\text{OUT}}$  in order to achieve optimal efficiency. Other features include: 1.5% LED current matching between channels, open LED reporting, shorted LED pin protection and reporting, programmable LED current and programmable temperature protection.

LT, LT, LTC, LTM, Linear Technology and the Linear logo are registered trademarks of Linear Technology Corporation and True Color PWM is a trademark of Linear Technology Corporation. All other trademarks are the property of their respective owners.

## TYPICAL APPLICATION

### 48V 1MHz Step-Down 8W, 100mA LED Driver (Eight White LEDs per Channel)

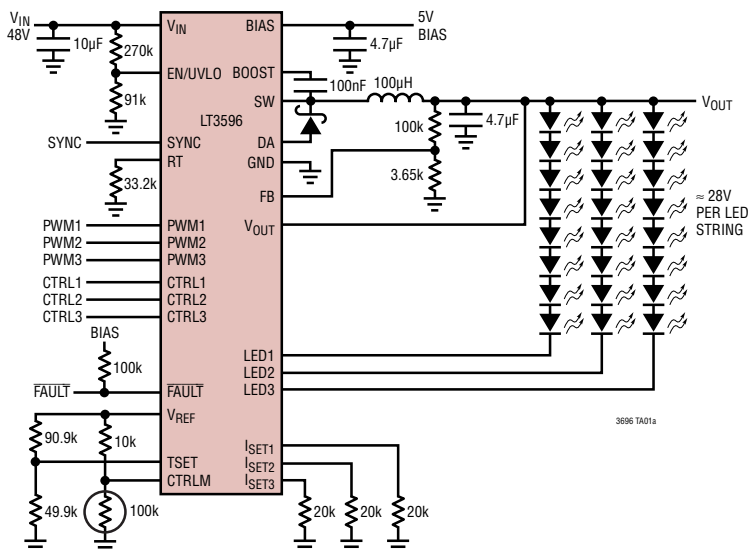

10,000:1 PWM Dimming at 100Hz

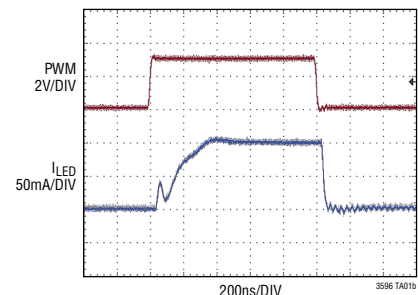

## ABSOLUTE MAXIMUM RATINGS

(Note 1)

Input Voltage ( $V_{IN}$ ), EN/UVLO .....	60V
BOOST .....	80V
BOOST Pin Above SW Pin .....	25V
LED1-3, $V_{OUT}$ .....	42V
BIAS, $\overline{FAULT}$ .....	25V
$V_{REF}$ , RT, $I_{SET1-3}$ , TSET, CTRLM .....	3V
FB, CTRL1-3, PWM1-3, SYNC .....	6V
Operating Temperature Range	
(Notes 2, 3) .....	-40°C to 125°C
Maximum Junction Temperature .....	125°C
Storage Temperature Range .....	-65°C to 150°C

## PIN CONFIGURATION

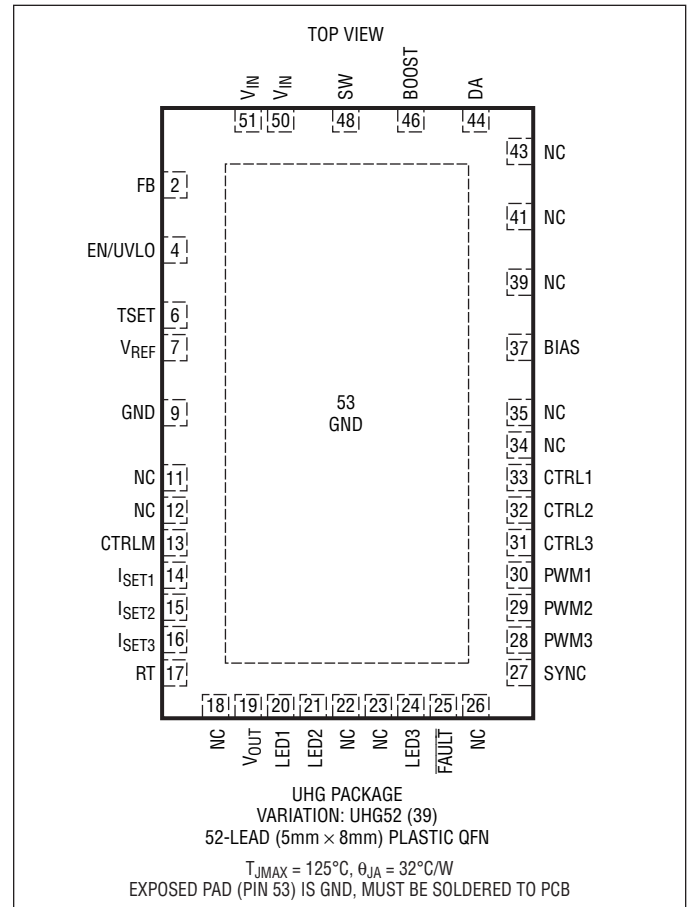

## ORDER INFORMATION

LEAD FREE FINISH	TAPE AND REEL	PART MARKING*	PACKAGE DESCRIPTION	TEMPERATURE RANGE
LT3596EUHG#PBF	LT3596EUHG#TRPBF	3596	52-Lead (5mm × 8mm) Plastic QFN	-40°C to 125°C
LT3596IUHG#PBF	LT3596IUHG#TRPBF	3596	52-Lead (5mm × 8mm) Plastic QFN	-40°C to 125°C

Consult LTC Marketing for parts specified with wider operating temperature ranges. \*The temperature grade is identified by a label on the shipping container. Consult LTC Marketing for information on non-standard lead based finish parts.

For more information on lead free part marking, go to: <http://www.linear.com/leadfree/>

For more information on tape and reel specifications, go to: <http://www.linear.com/tapeandreeel/>

**ELECTRICAL CHARACTERISTICS** The ● denotes the specifications which apply over the full operating temperature range, otherwise specifications are at  $T_A = 25^\circ\text{C}$ .  $V_{IN} = 24\text{V}$ ,  $\text{BOOST} = 30\text{V}$ ,  $\text{BIAS} = 5\text{V}$ ,  $\text{EN/UVLO} = 5\text{V}$ ,  $\text{PWM1-3} = 3.3\text{V}$ ,  $\text{CTRL1-3} = \text{CTRLM} = \text{TSET} = 2\text{V}$ ,  $V_{OUT} = 24\text{V}$ ,  $\text{SYNC} = 0\text{V}$  unless otherwise specified. (Note 2)

PARAMETER	CONDITIONS	MIN	TYP	MAX	UNITS
$V_{IN}$ Operating Voltage		● 6		55	V
Quiescent Current from $V_{IN}$	EN/UVLO = 0.4V BIAS = 5V, Not Switching BIAS = 0V, Not Switching			2 1.3 3	$\mu\text{A}$ mA mA
Minimum BIAS Voltage			3	3.1	V
Quiescent Current from BIAS	EN/UVLO = 0.4V BIAS = 5V, Not Switching BIAS = 0V, Not Switching, Current Out of Pin			2 1.4 70	$\mu\text{A}$ mA $\mu\text{A}$
EN Threshold		0.4	0.7		V
UVLO Threshold (Falling)		1.47	1.51	1.53	V
EN/UVLO Pin Current (Hysteresis)	EN/UVLO = 1.6V EN/UVLO = 1.4V		10 5.1	5.75	nA $\mu\text{A}$
FB Regulation Voltage		1.15	1.21	1.25	V
FB Pin Bias Current	FB = 6V			200	nA
Maximum Duty Cycle	$R_T = 220\text{k}$ (200kHz) $R_T = 33.2\text{k}$ (1MHz)	90 80	99 90		% %
Switch Saturation Voltage	$I_{SW} = 300\text{mA}$		330		mV
Switch Current Limit		0.8	1.0	1.25	A
DA Pin Current to Stop OSC		500	650	750	mA
Switch Leakage	$V_{SW} = 0\text{V}$			700	nA
BOOST Pin Current	$I_{SW} = 100\text{mA}$		3		mA
Switching Frequency	$R_T = 220\text{k}$ $R_T = 33.2\text{k}$	170 900	200 1000	230 1100	kHz kHz
SYNC Input Low				0.4	V
SYNC Input High		1.6			V
SYNC Frequency Range	$R_T = 220\text{k}$ $R_T = 47\text{k}$	240		1000	kHz kHz
SYNC Pin Bias Current	$V_{SYNC} = 3.3\text{V}$			200	nA
Soft-Start Time	(Note 4)		2.2		ms
$V_{REF}$ Voltage	$I_{VREF} = 0\mu\text{A}$	● 1.96	2.0	2.04	V
Maximum $V_{REF}$ Current		200			$\mu\text{A}$
$I_{SET1-3}$ Pin Voltage	$R_{ISET1-3} = 20\text{k}$		1.0		V
TSET Voltage for LED Current Derating			540		mV
TSET Pin Leakage Current	$V_{TSET} = 1\text{V}$			200	nA
$I_{LED1-3}$ LED Current	$R_{ISET1-3} = 20\text{k}$	● 98 97	100 100	102 103	mA mA
LED String Current Matching	$R_{ISET1-3} = 20\text{k}$	●	$\pm 0.35$ $\pm 0.35$	$\pm 1.5$ $\pm 2$	% %
LED Pin Voltage	Adaptive $V_{OUT}$ Loop Enabled		1.07		V
LED1-3 Open Detection Threshold			0.29		V
LED1-3 Short Protection Threshold (from GND)		10		15	V
LED1-3 Short Protection Threshold (from $V_{OUT}$ )	$V_{OUT} = 6\text{V}$ , $V_{OUT} > V_{LED1-3}$	1	1.2	1.6	V
LED1-3 Pin Leakage Current	$V_{LED1-3} = 42\text{V}$ , $\text{PWM1-3} = 0\text{V}$			200	nA

## ELECTRICAL CHARACTERISTICS

The ● denotes the specifications which apply over the full operating temperature range, otherwise specifications are at  $T_A = 25^\circ\text{C}$ .  $V_{IN} = 24\text{V}$ ,  $\text{BOOST} = 30\text{V}$ ,  $\text{BIAS} = 5\text{V}$ ,  $\text{EN/UVLO} = 5\text{V}$ ,  $\text{PWM1-3} = 3.3\text{V}$ ,  $\text{CTRL1-3} = \text{CTRLM} = \text{TSET} = 2\text{V}$ ,  $V_{OUT} = 24\text{V}$ ,  $\text{SYNC} = 0\text{V}$  unless otherwise specified. (Note 2)

PARAMETER	CONDITIONS	MIN	TYP	MAX	UNITS
PWM1-3 Input Low Voltage				0.4	V
PWM1-3 Input High Voltage		1.6			V
PWM1-3 Pin Bias Current				200	nA
CTRL1-3 Voltage for Full LED Current		1.2			V
CTRL1-3 Pin Bias Current	$V_{CTRL1-3} = 6\text{V}$			200	nA
CTRLM Voltage for Full LED Current		1.2			V
CTRLM Pin Bias Current	$V_{CTRLM} = 3\text{V}$			200	nA
FAULT Output Voltage Low	$I_{FAULT} = 200\mu\text{A}$		0.10		V
FAULT Pin Input Leakage Current	$V_{FAULT} = 25\text{V}$			200	nA

**Note 1:** Stresses beyond those listed under Absolute Maximum Ratings may cause permanent damage to the device. Exposure to any Absolute Maximum Rating condition for extended periods may affect device reliability and lifetime.

**Note 2:** The LT3596E is guaranteed to meet performance specifications from  $0^\circ\text{C}$  to  $125^\circ\text{C}$  junction temperature. Specifications over the  $-40^\circ\text{C}$  to  $125^\circ\text{C}$  operating junction temperature range are assured by design, characterization and correlation with statistical process controls. The LT3596I specifications are guaranteed over the full  $-40^\circ\text{C}$  to  $125^\circ\text{C}$  operating junction temperature range.

**Note 3:** For maximum operating ambient temperature, see the High Temperature Considerations section in the Applications Information section.

**Note 4:** Guaranteed by design.

**TYPICAL PERFORMANCE CHARACTERISTICS**  $T_A = 25^\circ\text{C}$ , unless otherwise noted

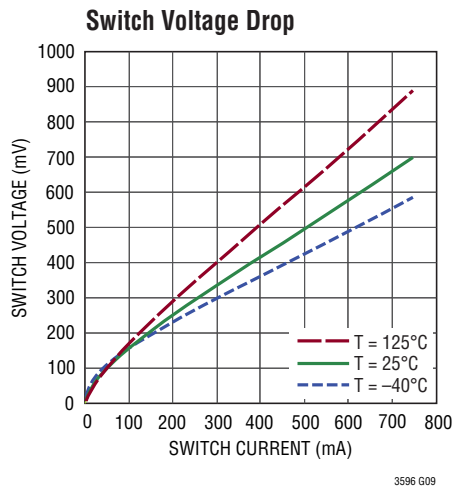
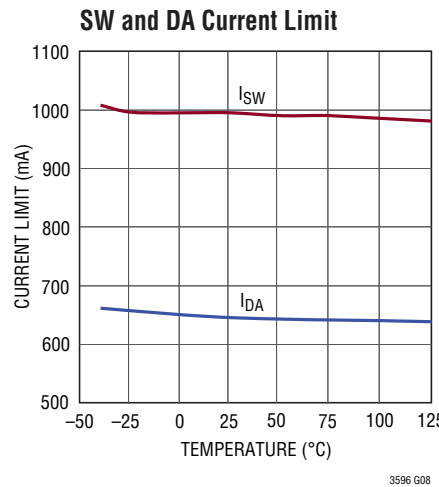
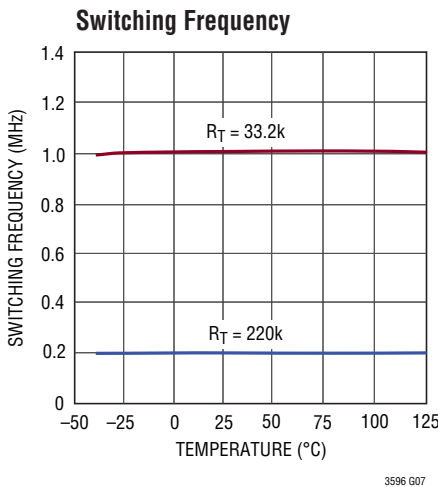
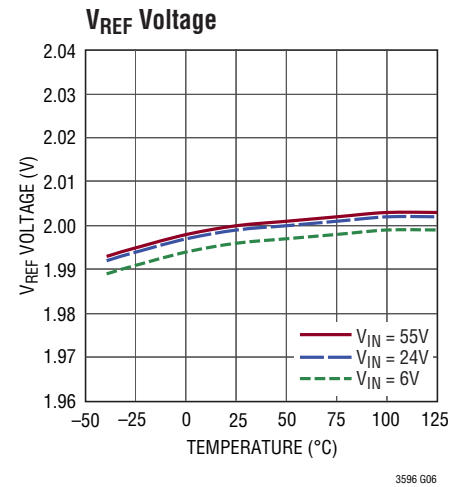
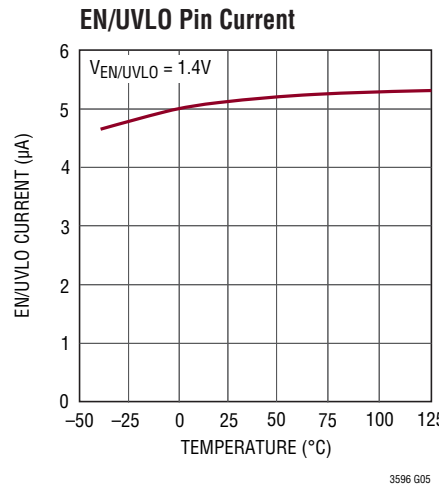
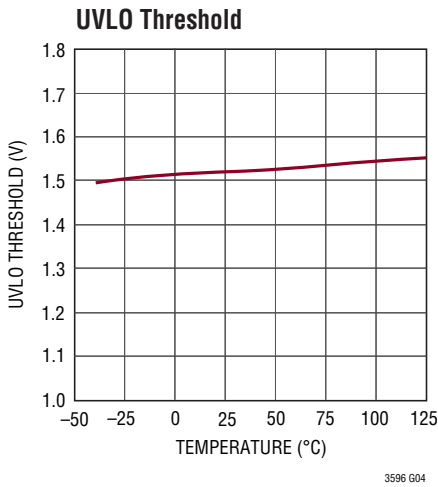
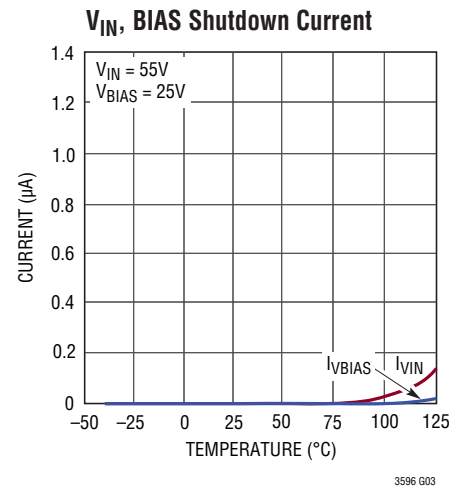
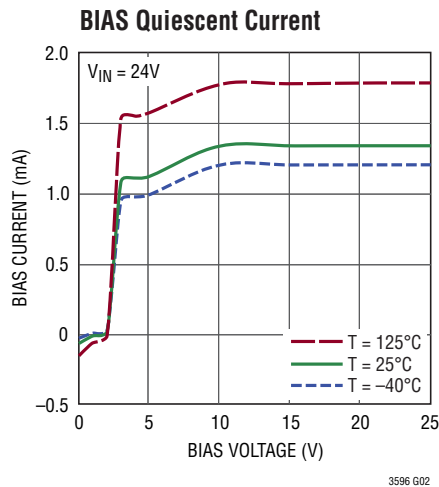
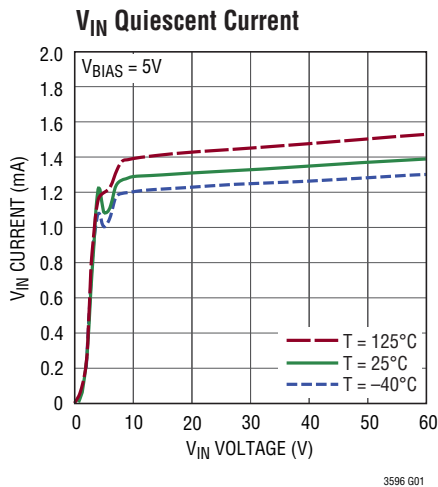

**TYPICAL PERFORMANCE CHARACTERISTICS**  $T_A = 25^\circ\text{C}$ , unless otherwise noted

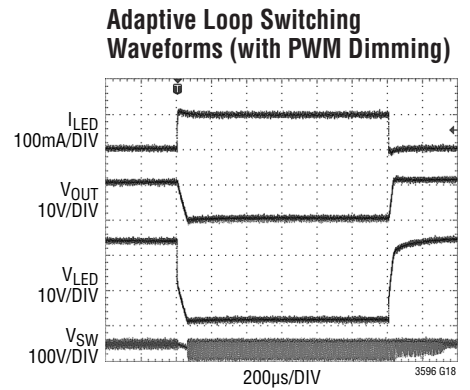
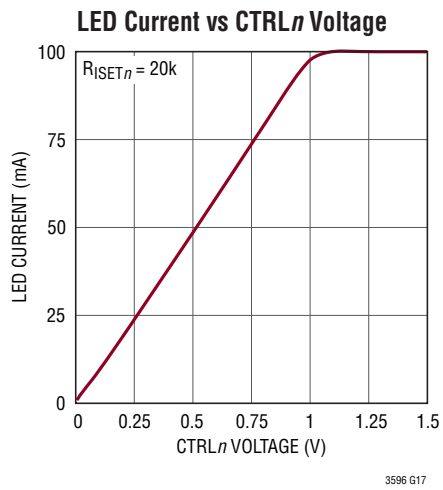
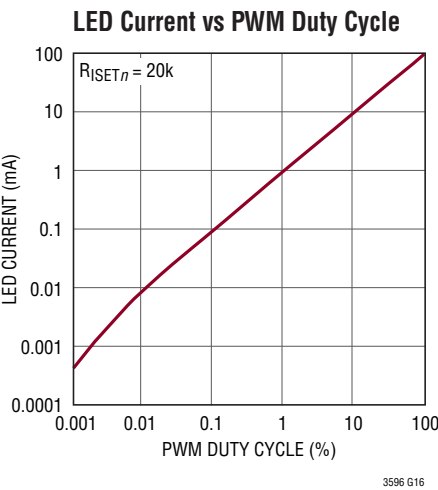
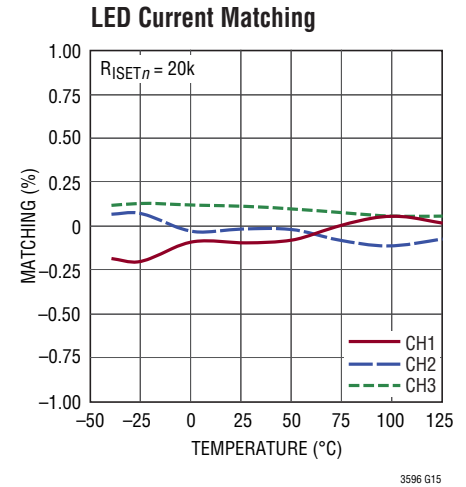
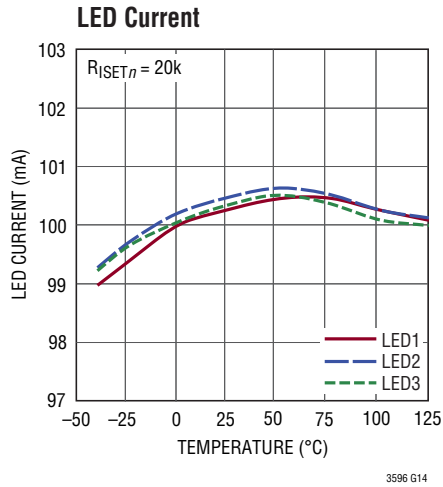
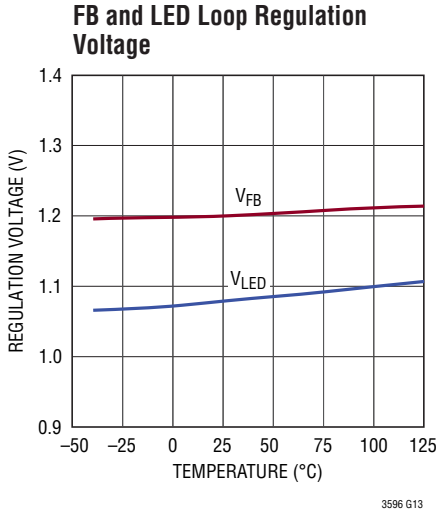
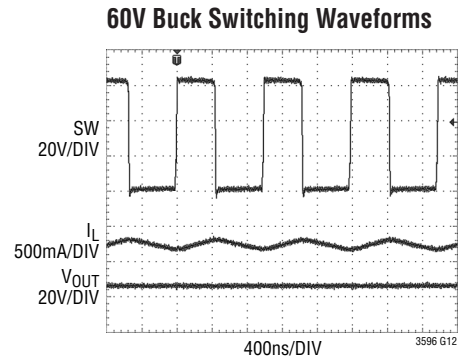
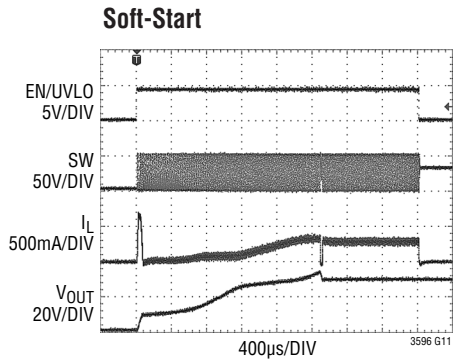
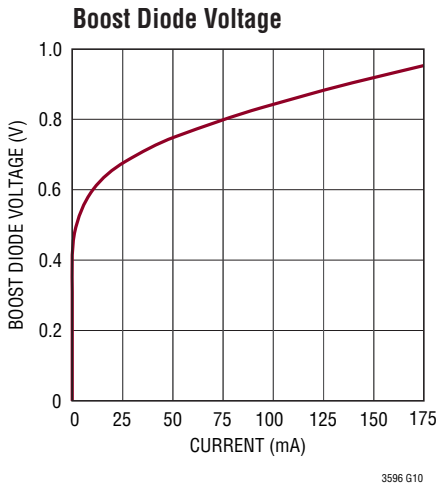

**TYPICAL PERFORMANCE CHARACTERISTICS**  $T_A = 25^\circ\text{C}$ , unless otherwise noted

**10,000:1 PWM Dimming at 100Hz**

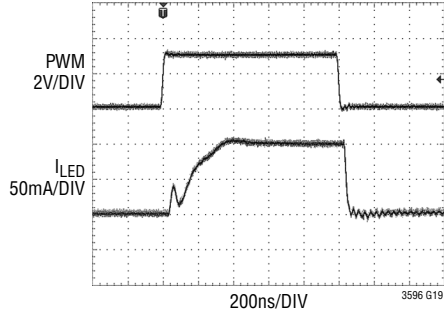

**1,000:1 PWM Dimming at 100Hz**

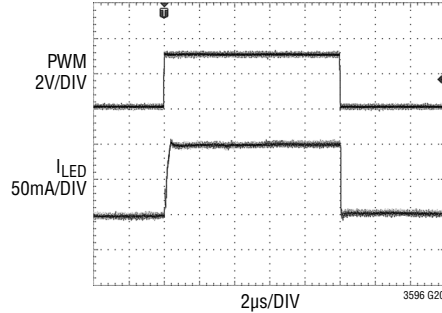

**PWM Dimming Waveforms (Overlapping PWM Signals)**

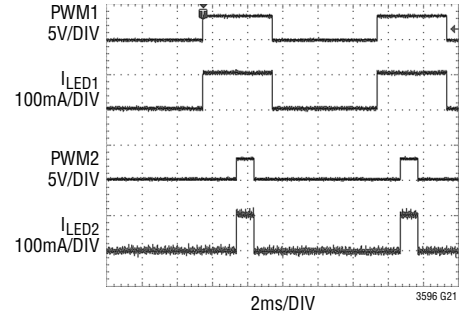

**PWM Dimming Waveforms (Nonoverlapping PWM Signals)**

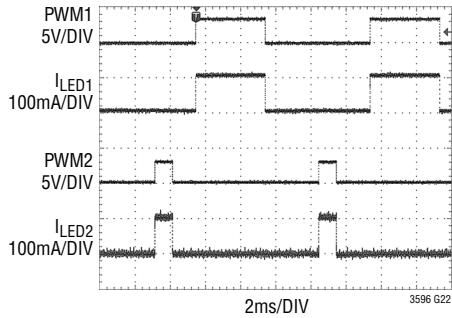

**LED Open-Fault Waveforms**

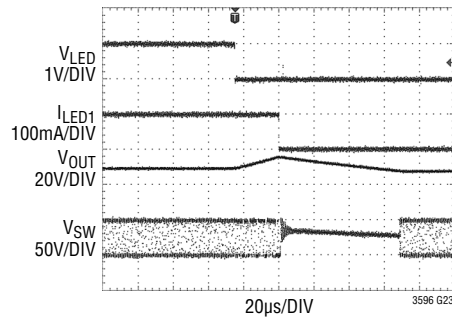

**LED Short to VOUT Waveforms**

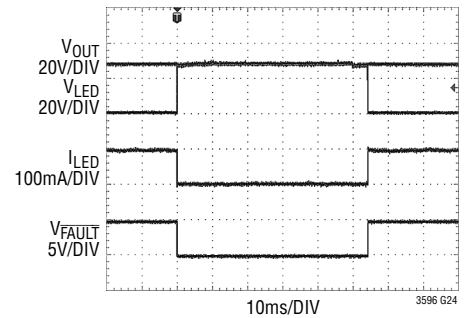

**FAULT Output Voltage**

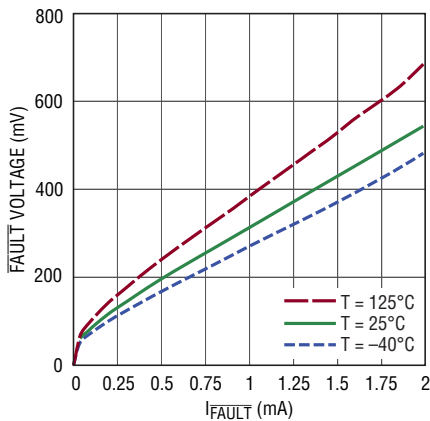

**$V_{TSET}$  for LED Current Derating**

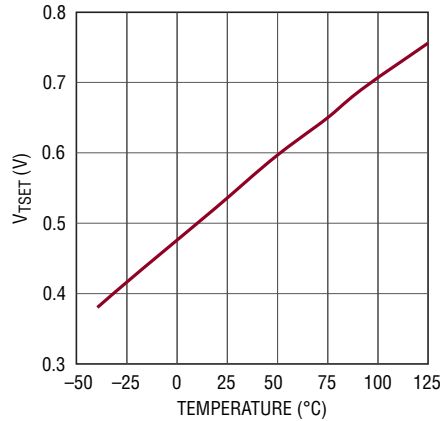

**TSET LED Current Derating**

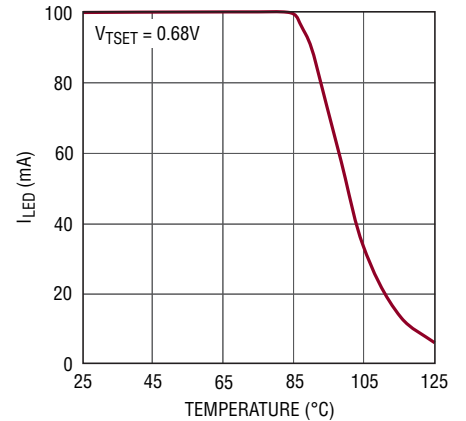

## PIN FUNCTIONS

**FB (Pin 2):** Feedback Pin. This pin is regulated to the internal bandgap voltage. The maximum buck output voltage is set by connecting this pin to a resistor divider from  $V_{OUT}$ .

**EN/UVLO (Pin 4):** Enable and Undervoltage Lockout Pin. Accurate 1.5V falling threshold. UVLO threshold is programmed by using a resistor divider from  $V_{IN}$ .

**TSET (Pin 6):** Thermal Regulation Pin. Programs the LT3596 junction temperature at which LED current begins to derate.

**$V_{REF}$  (Pin 7):** 2V Reference Output Pin. This pin sources up to 200 $\mu$ A and is used to program TSET and CTRLM.

**GND (Pin 9/Exposed Pad Pin 53):** Ground Pin. This is the ground for both the IC and the switching converter. Exposed pad must be soldered to PCB ground.

**NC (Pins 11, 12, 18, 22, 23, 26, 34, 35, 39, 41, 43):** No Connection Pins. Tie to ground if unused.

**CTRLM (Pin 13):** Master Control Pin. LED current derating vs temperature is achievable for all channels if the voltage on CTRLM has a negative coefficient using an external NTC resistor divider from  $V_{REF}$ .

**$I_{SET1}$ ,  $I_{SET2}$ ,  $I_{SET3}$  (Pins 14, 15, 16):** LED Current Programming Pin. Resistor to ground programs full-scale LED current.

**RT (Pin 17):** Switching Frequency Programming Pin. A resistor to ground programs switching frequency between 200kHz and 1MHz. For the SYNC function, choose the resistor to program a frequency 20% slower than the SYNC pulse frequency.

**$V_{OUT}$  (Pin 19):** Buck Output. This is the buck regulator output voltage sense into the IC.

**LED1, LED2, LED3 (Pins 20, 21, 24):** Constant-Current Sink Pin. These are three LED driver outputs, each containing an open collector, constant current sink. All outputs are matched within  $\pm 1.5\%$  and are individually programmed up to 100mA using an external resistor at the  $I_{SET1-3}$  pin. Outputs are rated to allow a maximum  $V_{OUT}$  of 42V. Connect the cathode of the LED string to LED1-3. Connect the anode of the LED string to  $V_{OUT}$ .

**$\overline{FAULT}$  (25):** Fault Detection Pin. Open-collector pin used to report open LED faults.  $\overline{FAULT}$  must be externally pulled to a positive supply.

**SYNC (Pin 27):** External Clock Synchronization Pin. When an external clock drives this pin, the buck regulator is synchronized to that frequency. Frequency programmed by the RT pin resistor must be at least 20% slower than the SYNC pin clock frequency.

**PWM1, PWM2, PWM3 (Pins 30, 29, 28):** PWM Dimming Control Pin. When driven to a logic high, the LED1-3 current sink is enabled. Channels can be individually disabled by tying PWM1-3 to ground. If PWM dimming is not desired then the pin should be connected to  $V_{REF}$ .

**CTRL1, CTRL2, CTRL3 (Pins 33, 32, 31):** Analog Dimming Control Pin. This pin is used to dim the LED current in an analog fashion. If the pin is tied to a voltage lower than 1.0V, it will linearly reduce the LED current. If unused the pin must be connected to  $V_{REF}$ .

**BIAS (37):** Supply Pin. This pin is the supply for an internal voltage regulator for analog and digital circuitry. BIAS must be locally bypassed with a 4.7 $\mu$ F capacitor.

**DA (44):** Catch Diode Anode. This pin is used to provide frequency foldback in extreme situations.

**BOOST (Pin 46):** Boost Capacitor Pin. This pin is used to provide a voltage above the input voltage when the switch is on. It supplies current to the switch driver.

**SW (Pin 48):** Switch Pin. Connect the inductor, catch diode and boost capacitor to this pin.

**$V_{IN}$  (Pins 50, 51):** Input Supply Pins. Pins are electrically connected inside the package.  $V_{IN}$  must be locally bypassed with a 10 $\mu$ F capacitor to ground.



**BLOCK DIAGRAM**

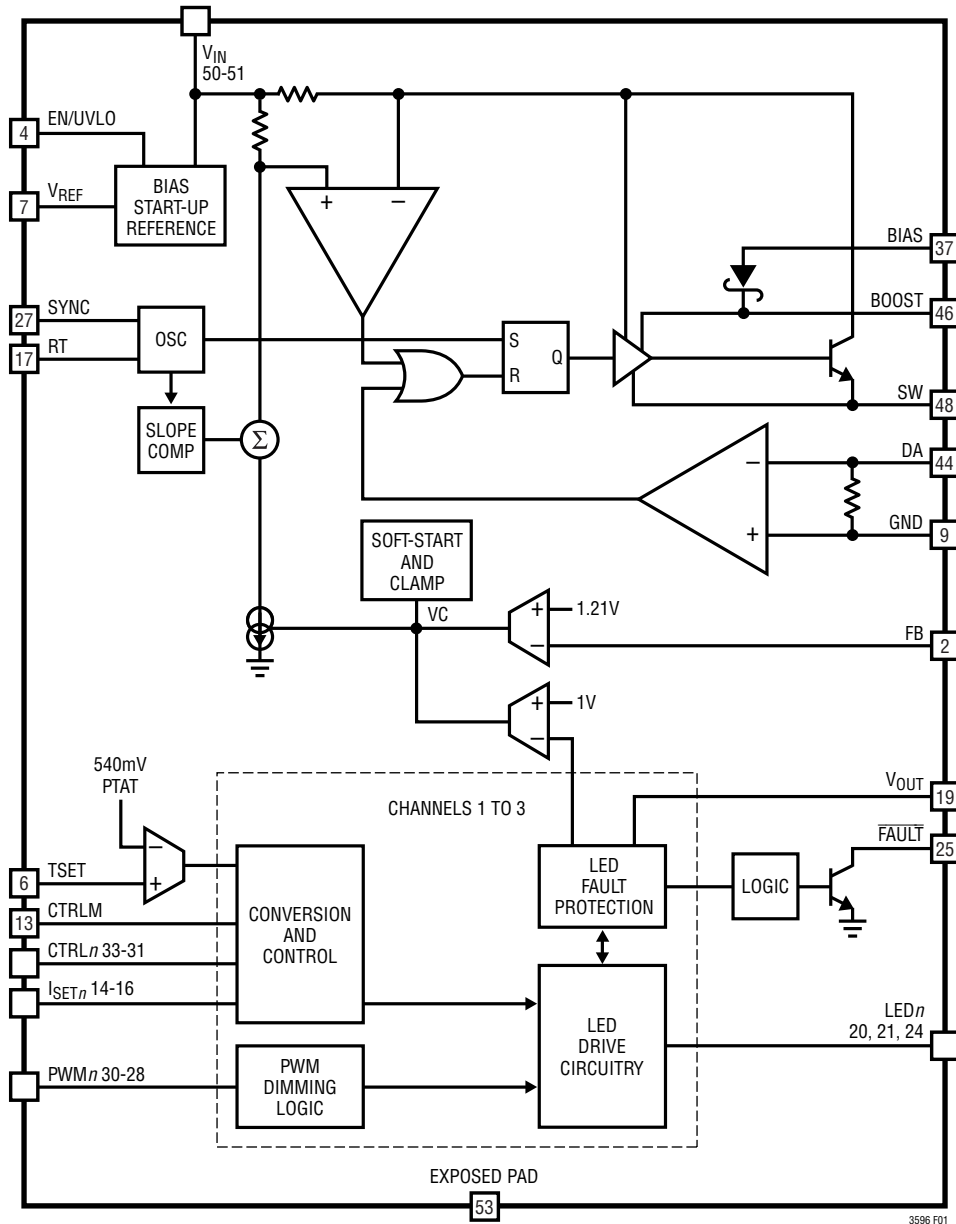

Figure 1. Block Diagram

3596 F01

## OPERATION

The LT3596 uses a constant-frequency, peak current mode control scheme to provide excellent line and load regulation. Operation is best understood by referring to the Block Diagram (Figure 1). The bias, start-up, reference, oscillator, TSET amplifier and the buck regulator are shared by the three LED current sources. The conversion and control, PWM dimming logic, LED fault detection, and LED drive circuitry are identical for all three current sources.

Enable and undervoltage lockout (UVLO) are both controlled by a single pin. If the EN/UVLO pin falls below 1.51V (typical), an accurate comparator turns off the LED drivers and the buck regulator. If the pin continues to fall to less than 0.4V, the part enters a low quiescent current shutdown mode.

The LT3596 contains three constant-current sink LED drivers. These drivers sink up to 100mA with 1.5% matching accuracy between LED strings. The LED strings are powered from the buck converter.

The buck converter contains an adaptive loop that adjusts the output voltage based on LED string voltage to ensure maximum efficiency. External compensation and soft-start components are not required, minimizing component count and simplifying board layout. An external resistor programs the buck's switching frequency between 200kHz and 1MHz. The frequency can also be synchronized to an external clock using the SYNC pin.

### Step-Down Adaptive Control

Adaptive control of the output voltage maximizes system efficiency. This control scheme regulates the output voltage to the minimum that ensures all three LED strings turn on. This accounts for the variation in the forward voltage of the LEDs, and minimizes the power dissipation across the internal current sources.

Activation of the adaptive loop is set by the status of the PWM $n$  pins. If any channel's PWM pin is low, then the buck regulator output ascends to an externally programmed output voltage. This voltage is always set above the maximum voltage drop of the LEDs. This guarantees that the buck output voltage is high enough to immediately supply the LED current once the strings are reactivated. As soon as all of the PWM pins transition high, the output voltage of the buck drops until the adaptive loop regulates the output with about 1V across the LED current sinks. This scheme optimizes the efficiency for the system since the output voltage regulates to the minimum voltage required for all three LED strings.

### LED Current

Each LED string current is individually programmed to a maximum of 100mA with 1.5% matching accuracy between the strings. An external resistor on the I<sub>SET $n$</sub>  pin programs the maximum current for each string. The CTRL $n$  pin is used for analog dimming. Digital dimming is programmed using the PWM $n$  pin. A dimming ratio of 10,000:1 is achievable at a frequency of 100Hz.

### Fault Protection and Reporting

The LT3596 features diagnostic circuitry that protects the system in the event that a LED $n$  pin is shorted to an undesirable voltage. The LT3596 detects when the LED $n$  voltage exceeds 12V or is within 1.2V of V<sub>OUT</sub> when the LED string is sinking current. If either faulted condition occurs, the channel is disabled until the fault is removed. The fault is reported on  $\overline{\text{FAULT}}$  until the fault has cleared.

The LT3596 also offers open-LED detection and reporting. If a LED string is opened and no current flows in the string, then a fault is reported on  $\overline{\text{FAULT}}$ . A fault is also reported if the internal die temperature reaches the TSET programmed derating limit. LED faults are only reported if the respective PWM signal is high.

## APPLICATIONS INFORMATION

### Inductor Selection

Inductor values between 100µH and 470µH are recommended for most applications. It is important to choose an inductor that can handle the peak current without saturating. The inductor DCR (copper wire resistance) must also be low in order to minimize I<sup>2</sup>R power losses. Table 1 lists several recommended inductors.

**Table 1. Recommended Inductors**

PART	L (µH)	MAX DCR (Ω)	CURRENT RATING (A)	VENDOR
MSS1038	100	0.3	1.46	Coilcraft www.coilcraft.com
MSS1038	220	0.76	0.99	
MSS1246T	470	0.935	1.0	
CDRH10D68	100	0.205	1.5	Sumida www.sumida.com
	220	0.362	1.0	
CDRH12D58R	470	0.67	1.01	
DS1262C2	100	0.17	1.5	Toko www.toko.com
	220	0.35	1.0	
VLF10040	100	0.22	1.3	TDK www.tdk.com
	220	0.47	0.9	
DR124	100	0.26	1.79	Coiltronics www.cooperet.com
	220	0.56	1.15	
DR127	470	0.861	1.6	
DR74	100	0.383	0.99	
744771220	220	0.40	1.2	Würth Elektronik www.we-online.com

### Capacitor Selection

Low ESR (equivalent series resistance) capacitors should be used at the outputs to minimize output ripple voltage. Use only X5R or X7R dielectrics, as these materials retain their capacitance over wider voltage and temperature ranges than other dielectrics. Table 2 lists some suggested manufacturers. Consult the manufacturers for detailed information on their entire selection of ceramic surface mount parts.

**Table 2. Recommended Ceramic Capacitor Manufacturers**

Taiyo Yuden	www.t-yuden.com
AVX	www.avxcorp.com
Murata	www.murata.com
Kemet	www.kemet.com
TDK	www.tdk.com

Typically 10µF capacitors are sufficient for the V<sub>IN</sub> and BIAS pins. The output capacitor for the buck regulator depends on the number of LEDs and switching frequency. Refer to Table 3 for the proper output capacitor selection.

**Table 3. Recommended Output Capacitor Values (Volts/LED = 3.5V)**

SWITCHING FREQUENCY (kHz)	# LEDs	C <sub>OUT</sub> (µF)
1000	1 to 3	6.8
	>3	4.7
500	1 to 3	10
	>3	6.8
200	1 to 3	22
	>3	10

### Diode Selection

Schottky diodes, with their low forward voltage drop and fast switching speed, must be used for all LT3596 applications. Do not use P-N junction diodes. The diode's average current rating must exceed the application's average current. The diode's maximum reverse voltage must exceed the application's input voltage. Table 4 lists some recommended Schottky diodes.

**Table 4. Recommended Diodes**

PART	MAX CURRENT (A)	MAX REVERSE VOLTAGE (V)	MANUFACTURER
DFLS160	1	60	Diodes, Inc. www.diodes.com
CMMSH1-60	1	60	Central Semiconductor www.centralsemi.com
ESIPB	1	100	Vishay www.vishay.com

### Undervoltage Lockout (UVLO)

EN/UVLO programs the UVLO threshold by connecting the pin to a resistor divider from V<sub>IN</sub> as shown in Figure 2.

Select R1 and R2 according to the following equation:

$$V_{IN(UVLO)} = 1.51V \cdot \left( 1 + \frac{R2}{R1} \right)$$

APPLICATIONS INFORMATION

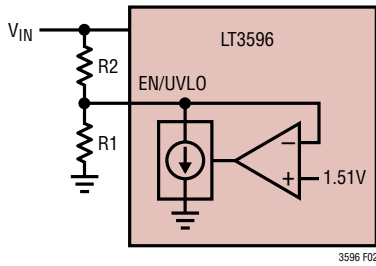

Figure 2. EN/UVLO Control

In UVLO an internal 5.1µA (typical) pull-down current source is connected to the pin for programmable UVLO hysteresis. The hysteresis is set according to the following equation:

$$V_{UVLO(HYST)} = 5.1\mu A \cdot R2$$

Care must be taken if too much hysteresis is programmed, the pin voltage might drop too far and cause the current source to saturate.

Once the EN/UVLO pin goes below 0.4V, the part enters shutdown.

Programming Maximum LED Current

Maximum LED current is programmed by placing a resistor (R<sub>ISETn</sub>) between the I<sub>SETn</sub> pin and ground. R<sub>ISETn</sub> values between 20k and 100k can be chosen to set the maximum LED current between 100mA and 20mA respectively.

The LED current is programmed according to the following equation:

$$I_{LED1-3} = 1V \cdot \frac{2000}{R_{ISETn}}$$

where R<sub>ISETn</sub> is in kΩ and I<sub>LEDn</sub> is in mA. See Table 5 and Figure 3 for resistor values and corresponding programmed LED current.

Table 5. R<sub>ISETn</sub> Value for LED Current

R <sub>ISETn</sub> VALUE (kΩ)	LED CURRENT (mA)
20	100
24.9	80
33.2	60
49.9	40
100	20

LED Current Dimming

The LT3596 has two different types of dimming control. The LED current is dimmed using the CTRL<sub>n</sub> pin or the PWM<sub>n</sub> pin.

For some applications, a variable DC voltage that adjusts the LED current is the preferred method for brightness control. In this case, the CTRL<sub>n</sub> pin is modulated to set the LED dimming. As the CTRL<sub>n</sub> pin voltage rises from 0V to 1V, the LED current increases from 0mA to the maximum programmed LED current in a linear fashion (see Figure 4). As the CTRL<sub>n</sub> pin increases beyond 1V, the maximum programmed LED current is maintained. If this type of dimming control is not desired, the CTRL<sub>n</sub> pin can be connected to V<sub>REF</sub>.

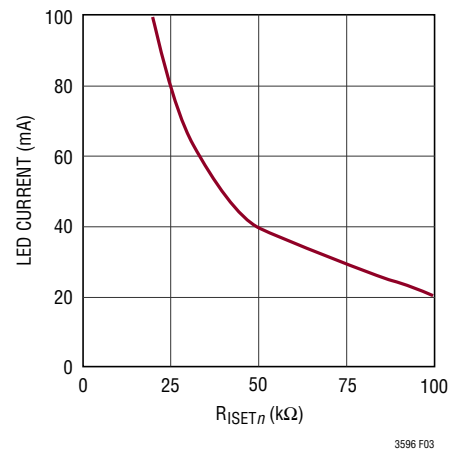

Figure 3. R<sub>ISETn</sub> Value for LED Current

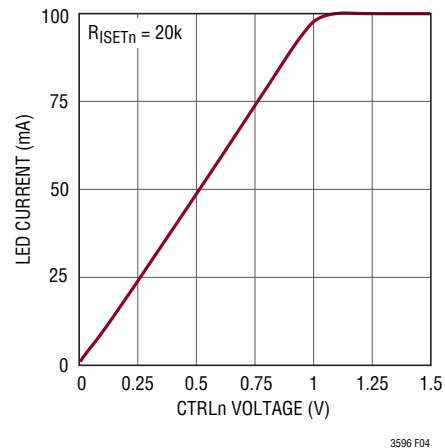

Figure 4. LED Current vs CTRL<sub>n</sub> Voltage

## APPLICATIONS INFORMATION

For True Color PWM dimming, the LT3596 provides up to 10,000:1 PWM dimming range at 100Hz. This is done by reducing the duty cycle of the PWM<sub>n</sub> pin from 100% to 0.01% for a PWM frequency of 100Hz (see Figure 5). This equates to a minimum on time of 1μs and a maximum period of 10ms. PWM duty cycle dimming allows for constant LED color to be maintained over the entire dimming range.

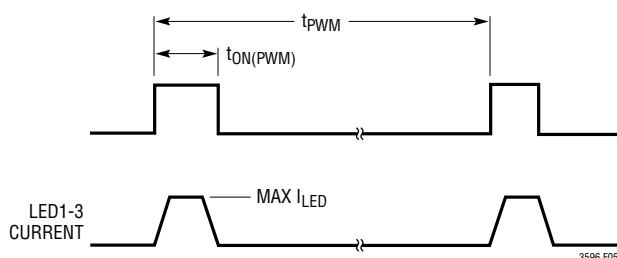

Figure 5. LED Current Using PWM Dimming

### Using the TSET Pin for Thermal Protection

The LT3596 contains a special programmable thermal regulation loop that limits the internal junction temperature. This thermal regulation feature provides important protection at high ambient temperatures. It allows an application to be optimized for typical, not worst-case, ambient temperatures with the assurance that the LT3596 automatically protects itself and the LED strings under worst-case conditions.

As the ambient temperature increases, so does the internal junction temperature of the part. Once the programmed maximum junction temperature is reached, the LT3596 linearly reduces the LED current, as needed, to maintain this junction temperature. This is only achieved when the ambient temperature stays below the maximum programmed junction temperature. If the ambient temperature continues to rise above the programmed maximum junction temperature, the LED current will reduce to less than 10% of the full current.

A resistor divider from the V<sub>REF</sub> pin programs the maximum IC junction temperature as shown in Figure 6.

Table 6 shows commonly used values for R1 and R2. Choose the ratio of R1 and R2 for the desired junction temperature limit as shown in Figure 7.

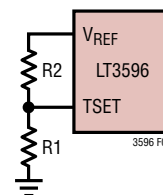

Figure 6. Programming the TSET Pin

Table 6. TSET Programmed Junction Temperature

T <sub>J</sub> (°C)	R1 (kΩ)	R2 (kΩ)
85	49.9	97.6
100	49.9	90.9
115	49.9	84.5

The TSET pin must be tied to V<sub>REF</sub> if the temperature protection feature is not desired.

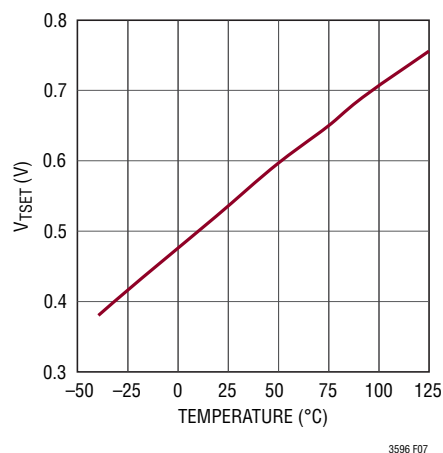

Figure 7. V<sub>TSET</sub> for LED Current Derating

### LED Current Derating Using the CTRLM Pin

A useful feature of the LT3596 is its ability to program a derating curve for maximum LED current versus temperature. LED data sheets provide curves of maximum allowable LED current versus temperature to warn against exceeding this current limit and damaging the LED. The LT3596 allows the output LEDs to be programmed for maximum allowable current while still protecting the LEDs from excessive currents at high temperature. This is achieved by programming a voltage at the CTRLM pin with a negative temperature coefficient using a resistor divider with temperature-dependent resistance (Figure 8). As ambient temperature increases, the CTRLM voltage falls below the internal 1V voltage reference, causing

3596fa

APPLICATIONS INFORMATION

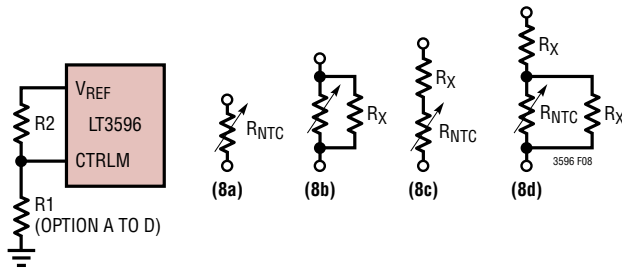

Figure 8. Programming the CTRLM Pin

LED currents to be controlled by the CTRLM pin voltage. The LED current-curve breakpoint and slope versus temperature are defined by the choice of resistor ratios and use of temperature-dependent resistance in the divider for the CTRLM pin.

Table 7 shows a list of manufacturers/distributors of NTC resistors. There are several other manufacturers available. The chosen supplier should be contacted for more detailed information.

Table 7. NTC Resistor Manufacturers/Distributors

Murata	www.murata.com
TDK Corporation	www.tdk.com
Digi-Key	www.digikey.com

If an NTC resistor is used to indicate LED temperature, it is effective only if the resistor is placed as close as possible to the LED strings. LED derating curves shown by manufacturers are listed for ambient temperature. The NTC resistor should have the same ambient temperature as the LEDs. Since the temperature dependence of an NTC resistor is nonlinear as a function of temperature, it is important to obtain its temperature characteristics from the manufacturer. Hand calculations of the CTRLM voltage are then performed at each given temperature using the following equation:

$$V_{CTRLM} = V_{REF} \cdot \left( \frac{R1}{R1+R2} \right)$$

This produces a plot of  $V_{CTRLM}$  versus temperature. From this curve, the LED current is found using Figure 9.

Several iterations of resistor value calculations may be necessary to achieve the desired breakpoint and slope of the LED current derating curve.

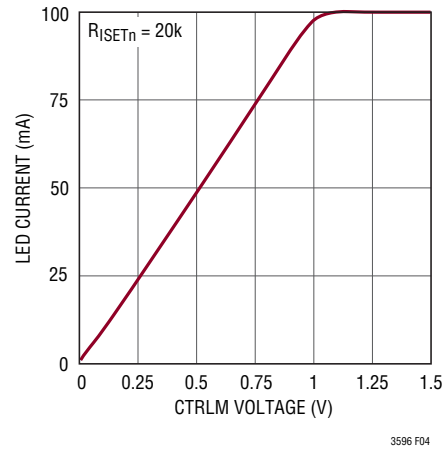

Figure 9. LED Current vs CTRLM Voltage

If calculating the CTRLM voltage at various temperatures gives a downward slope that is too strong, use alternative resistor networks (B, C, D in Figure 8). They use temperature independent resistance to reduce the effects of the NTC resistor over temperature.

Murata Electronics provides a selection of NTC resistors with complete data over a wide range of temperatures. In addition, a software tool is available which allows the user to select from different resistor networks and NTC resistor values, and then simulate the exact output voltage curve (CTRLM behavior) over temperature. Referred to as the Murata Chip NTC Thermistor Output Voltage Simulator, users can log on to www.murata.com and download the software followed by instructions for creating an output voltage  $V_{OUT}$  (CTRLM) from a specified  $V_{CC}$  supply ( $V_{REF}$ ).

The CTRLM pin must be tied to  $V_{REF}$  if the temperature derating function is not desired.

Programming Switching Frequency

The switching frequency of the LT3596 can be programmed between 200kHz and 1MHz by an external resistor connected between the RT pin and ground. Do not leave this pin open. See Table 8 and Figure 10 for resistor values and corresponding frequencies.

Selecting the optimum switching frequency depends on several factors. Inductor size is reduced with higher frequency, but efficiency drops slightly due to higher switching



## APPLICATIONS INFORMATION

losses. Some applications require very low duty cycles to drive a small number of LEDs from a high supply. Low switching frequency allows a greater range of operational duty cycle and so a lower number of LEDs can be driven. In each case, the switching frequency can be tailored to provide the optimum solution. When programming the switching frequency, the total power losses within the IC should be considered.

**Table 8. R<sub>T</sub> Resistor Selection**

R <sub>T</sub> VALUE (kΩ)	SWITCHING FREQUENCY (MHz)
33.2	1.0
80.6	0.5
220	0.2

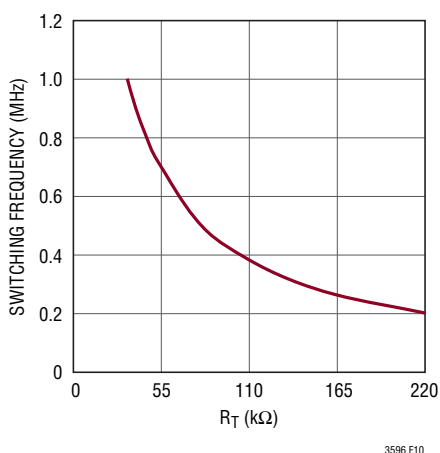

**Figure 10. Programming Switching Frequency**

### Switching Frequency Synchronization

The nominal operating frequency of the LT3596 is programmed using a resistor from the R<sub>T</sub> pin to ground. The frequency range is 200kHz to 1MHz. In addition, the internal oscillator can be synchronized to an external clock applied to the SYNC pin. The synchronizing clock signal input to the LT3596 must have a frequency between 240kHz and 1MHz, a duty cycle between 20% and 80%, a low state below 0.4V and a high state above 1.6V. Synchronization signals outside of these parameters cause erratic switching behavior. For proper operation, an R<sub>T</sub> resistor is chosen to program a switching frequency 20% slower than the SYNC pulse frequency. Synchronization occurs at a fixed delay after the rising edge of SYNC.

The SYNC pin must be grounded if the clock synchronization feature is not used. When the SYNC pin is grounded, the internal oscillator controls the switching frequency of the converter.

### Operating Frequency Trade-Offs

Selection of the operating frequency is a trade-off between efficiency, component size, input voltage and maximum output voltage. The advantage of high frequency operation is smaller component size and value. The disadvantages are lower efficiency and lower maximum output voltage for a fixed input voltage. The highest acceptable switching frequency (f<sub>SW(MAX)</sub>) for a given application can be calculated as follows:

$$f_{SW(MAX)} = \frac{V_D + V_{OUT}}{t_{ON(MIN)}(V_D + V_{IN} - V_{SW})}$$

where V<sub>IN</sub> is the typical input voltage, V<sub>OUT</sub> is the output voltage, V<sub>D</sub> is the catch diode drop (~0.5V) and V<sub>SW</sub> is the internal switch drop (~0.4V at max load). This equation shows that slower switching is necessary to accommodate high V<sub>IN</sub>/V<sub>OUT</sub> ratios. The input voltage range depends on the switching frequency due to the finite minimum switch on and off times. The switch minimum on and off times are 150ns.

### Adaptive Loop Control

The LT3596 uses an adaptive control mechanism to set the buck output voltage. This control scheme ensures maximum efficiency while not compromising minimum PWM pulse widths. When any PWM<sub>n</sub> is low, the output of the buck rises to a maximum value set by an external resistor divider to the FB pin. When all PWM<sub>n</sub> pins go high, the output voltage is adaptively reduced until the voltage across the LED current sink is about 1V. Figure 11 shows how the maximum output voltage is set by an external resistor divider.

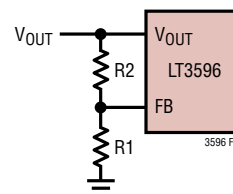

**Figure 11. Programming Maximum V<sub>OUT</sub>**

## APPLICATIONS INFORMATION

The maximum output voltage must be set to exceed the maximum LED drop plus 1.07V by a margin greater than 15%. However, this margin must not exceed a value of 10V. This ensures proper adaptive loop control. The equation below is used to estimate the resistor divider ratio. The sum of the resistors should be approximately 100k to avoid noise coupling to the FB pin.

$$V_{OUT(MAX)} = 1.15 \cdot (V_{LED(MAX)} + 1.07V) = 1.21V \cdot \left(1 + \frac{R2}{R1}\right)$$

$$V_{OUT(MAX)} = V_{LED(MAX)} + 1.07V + V_{MARGIN}$$

$$V_{MARGIN} \leq 10V$$

### Minimum Input Voltage

The minimum input voltage required to generate an output voltage is limited by the maximum duty cycle and the output voltage ( $V_{OUT}$ ) set by the FB resistor divider. The duty cycle is:

$$DC = \frac{V_D + V_{OUT}}{V_{IN} - V_{CESAT} + V_D}$$

where  $V_D$  is the Schottky forward drop and  $V_{CESAT}$  is the saturation voltage of the internal switch. The minimum input voltage is:

$$V_{IN(MIN)} = \left( \frac{V_D + V_{OUT(MAX)}}{DC_{MAX}} \right) + V_{CESAT} - V_D$$

where  $V_{OUT(MAX)}$  is calculated from the equation in the Adaptive Loop Control section, and  $DC_{MAX}$  is the minimum rating of the maximum duty cycle.

### Start-Up

At start-up, when  $V_{OUT}$  reaches 90% of the FB programmed output voltage, the adaptive loop is enabled. At this point, the LED string with the highest voltage drop is selected. The output voltage reduces until the selected string's LED pin is about 1V. This regulation method ensures that all three LED strings run their programmed current at a minimum output voltage despite mismatches in LED forward voltage. This minimizes the drop across the internal current sources and maximizes system efficiency.

Another benefit of this regulation method is that the LT3596 starts up with 10,000:1 dimming even if the PWM pulse

width is 1 $\mu$ s. Since  $V_{OUT}$  starts up even if PWM is low, the part achieves high dimming ratios with narrow pulse widths within a couple of PWM clock cycles.

### High Temperature Considerations

The LT3596 provides three channels for LED strings with internal NPN devices serving as constant current sources. When LED strings are regulated, the lowest LED pin voltage is typically 1V. For 100mA of LED current with a 100% PWM dimming ratio, at least 300mW is dissipated within the IC due to current sources. If the forward voltages of the three LED strings are very dissimilar, significant power dissipation will occur. Thermal calculations must include the power dissipation in the current sources in addition to conventional switch DC loss, switch transient loss and input quiescent loss. For best efficiency, it is recommended that each LED string have approximately the same voltage drop.

In addition, the die temperature of the LT3596 must be lower than the maximum rating of 125°C. This is generally not a concern unless the ambient temperature is above 100°C. Care should be taken in the board layout to ensure good heat sinking of the LT3596. The maximum load current (300mA) must be derated as the ambient temperature approaches 125°C. The die temperature is calculated by multiplying the LT3596 power dissipation by the thermal resistance from junction to ambient. Power dissipation within the LT3596 is estimated by calculating the total power loss from an efficiency measurement and subtracting the losses of the catch diode and the inductor. Thermal resistance depends on the layout of the circuit board, but 32°C/W is typical for the 5mm  $\times$  8mm QFN package.

### Board Layout

As with all switching regulators, careful attention must be paid to the PCB layout and component placement. To prevent electromagnetic interference (EMI) problems, proper layout of high frequency switching paths is essential. Minimize the length and area of all traces connected to the switching node (SW). Always use a ground plane under the switching regulator to minimize interplane coupling. Resistors connected between ground and the CTRL1-3, CTRLM, FB, TSET,  $I_{SETn}$ , RT and EN/UVLO pins are best connected to a quiet ground.



# TYPICAL APPLICATIONS

## 24V 200kHz Step-Down 4W, 100mA LED Driver

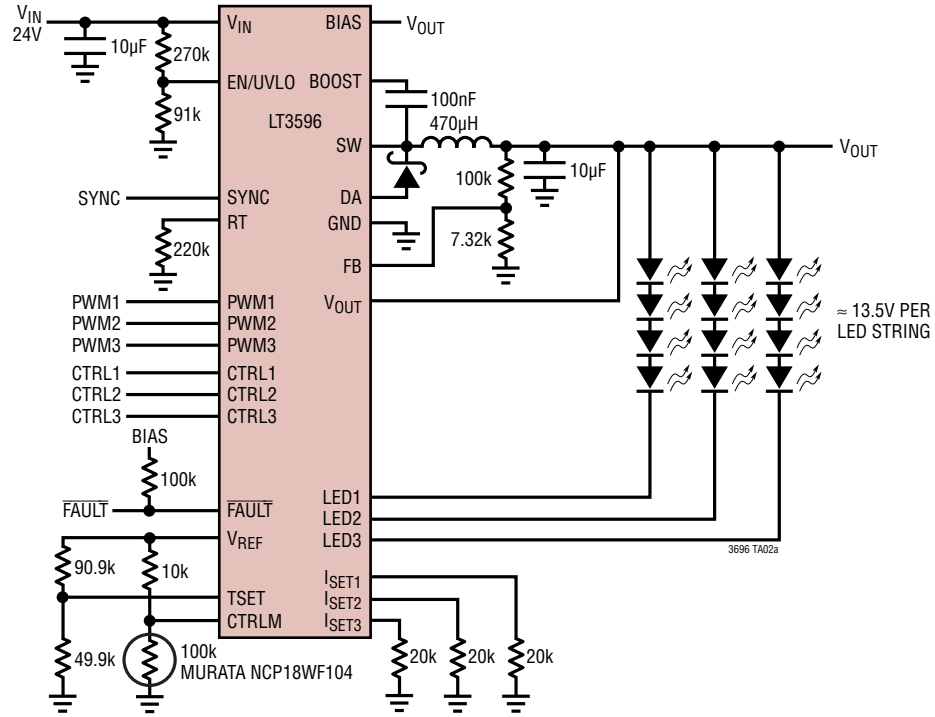

Efficiency

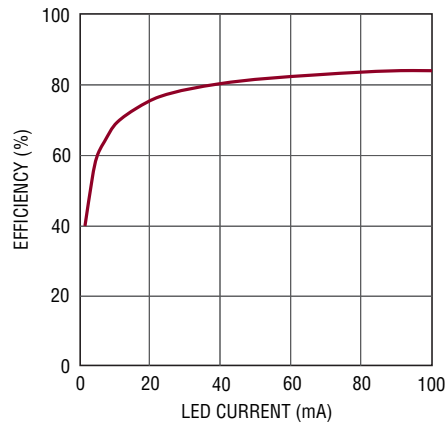

3596 TA02b

TYPICAL APPLICATIONS

12V 1MHz Step-Down 100mA Single Pixel R-G-B Driver

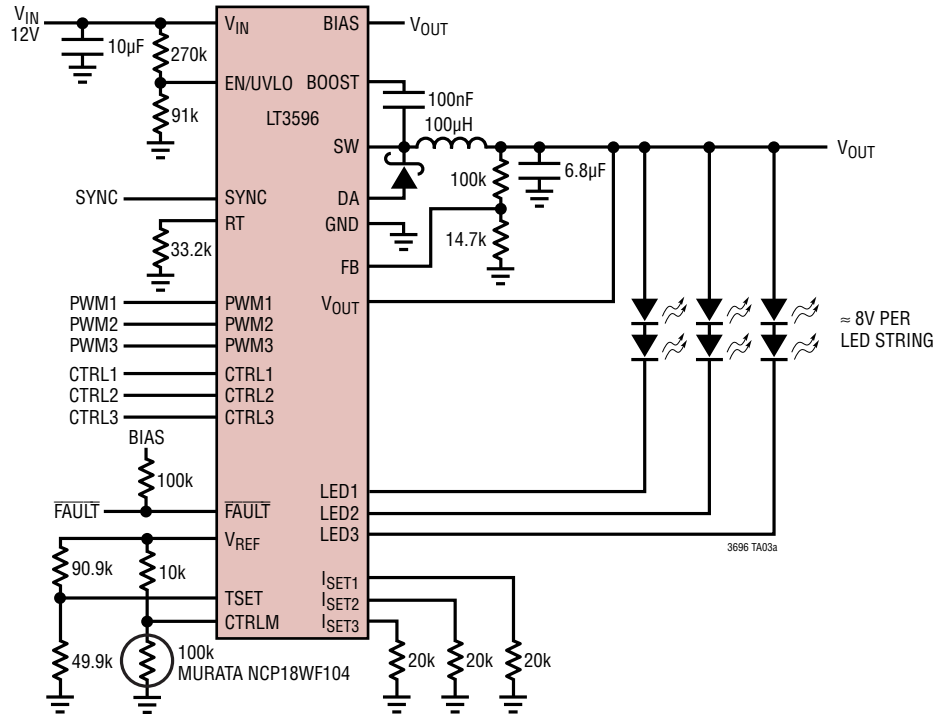

Efficiency

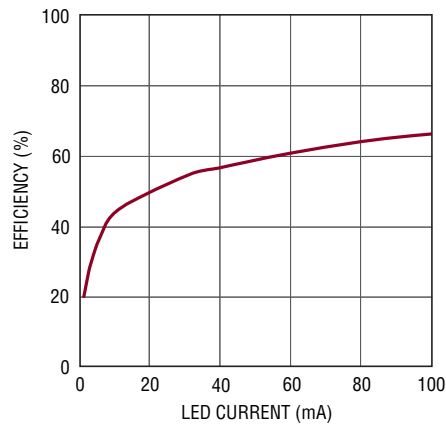

3596 TA03b

# TYPICAL APPLICATIONS

## 48V 500kHz Step-Down 10W, 100mA LED Driver

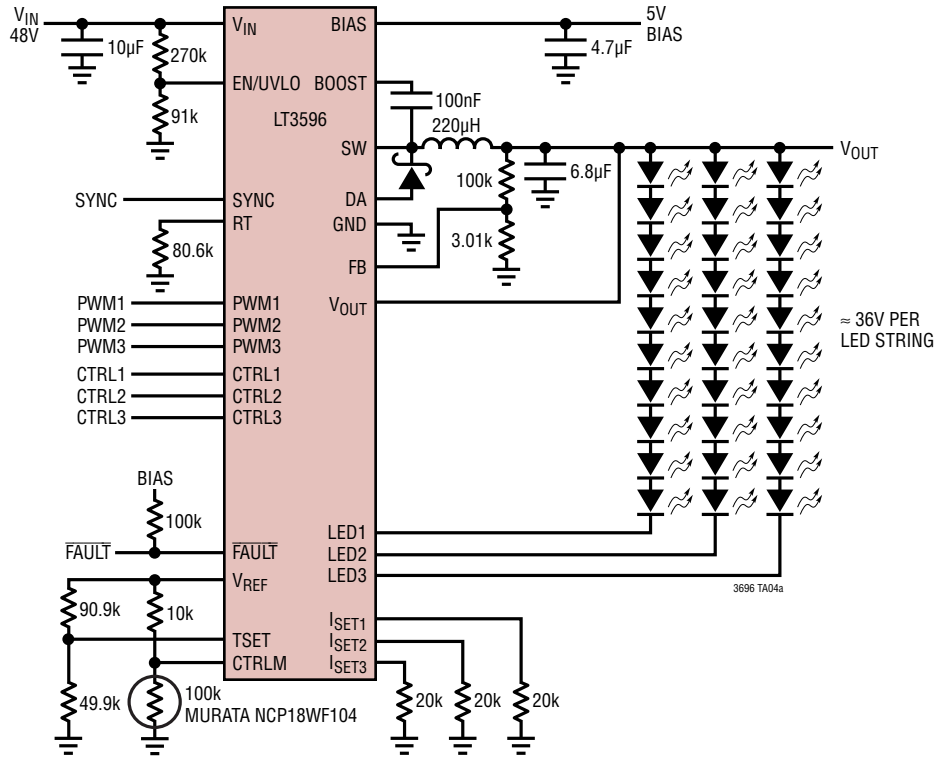

Efficiency

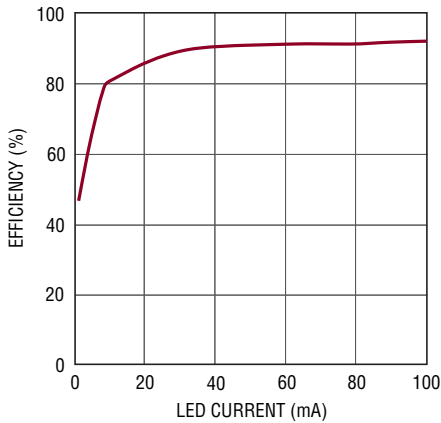

3596 TA04b

10,000:1 PWM Dimming at 100Hz

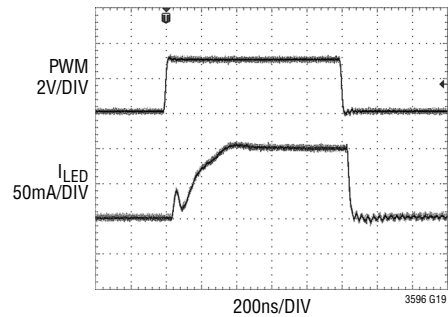

3596 G19

**PACKAGE DESCRIPTION**

**UHG Package**  
**Variation: UHG52 (39)**  
**52-Lead Plastic QFN (5mm × 8mm)**  
 (Reference LTC DWG # 05-08-1846 Rev B)

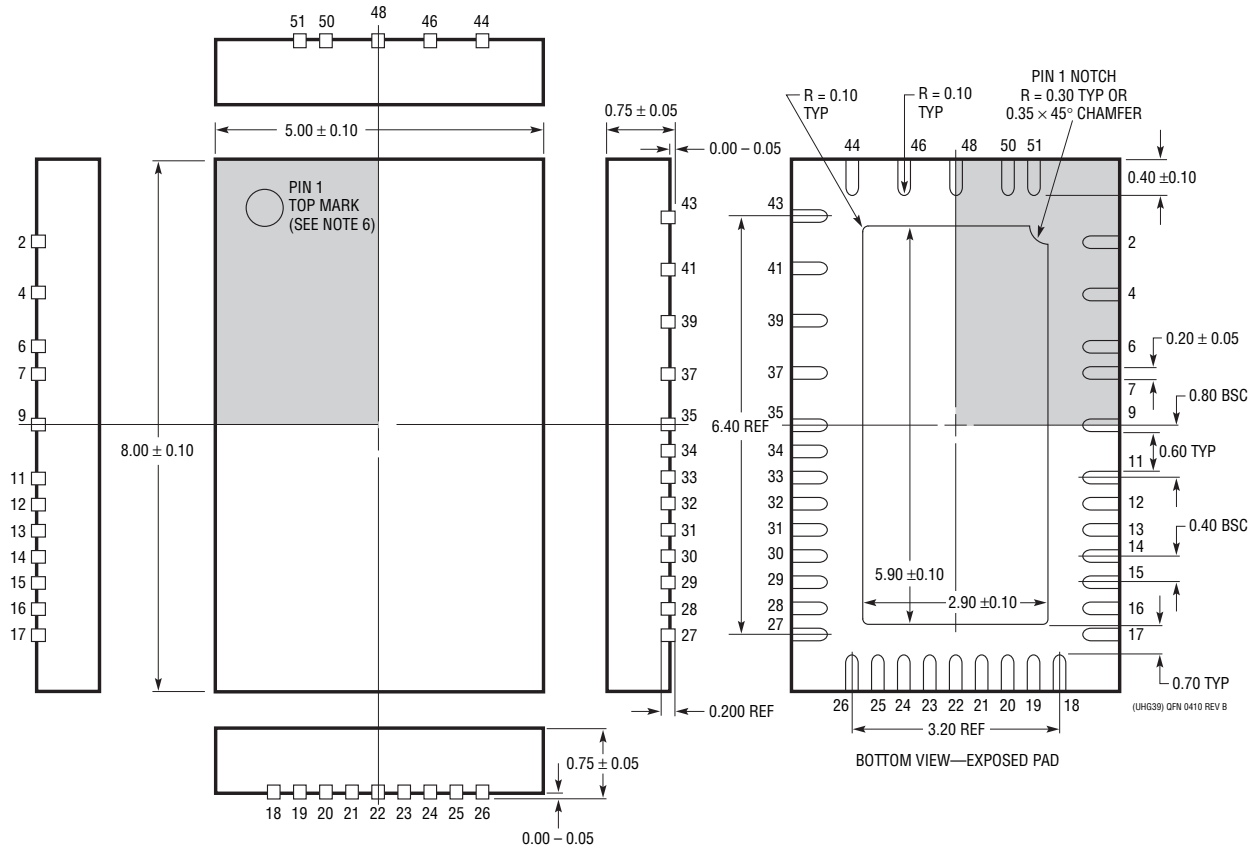
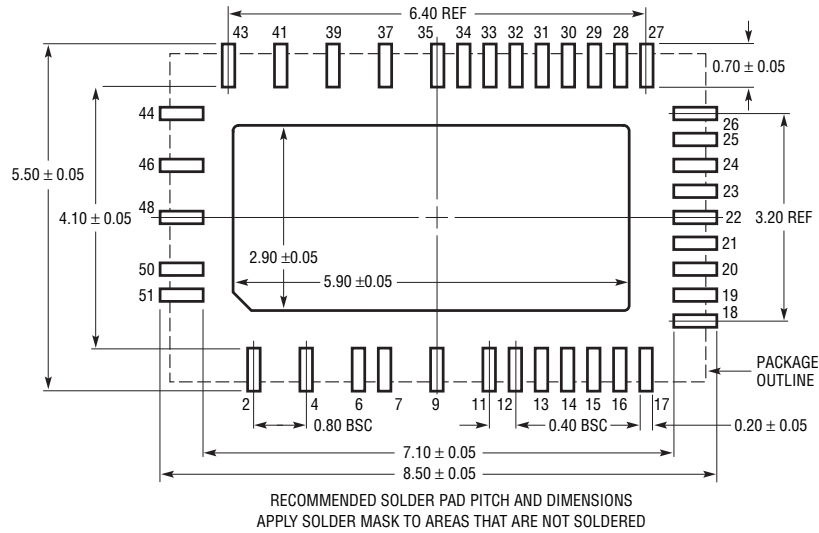

## REVISION HISTORY

REV	DATE	DESCRIPTION	PAGE NUMBER
A	9/10	Added " $\approx 28V$ per LED String" to Typical Application drawing	1, 22
		Added text and equations to Adaptive Loop Control section in Applications Information	16
		Added " $\approx 13.5V$ per LED String" and " $\approx 8V$ per LED String" to Typpplications drawings	17

## TYPICAL APPLICATION

### 48V 1MHz Step-Down 8W, 100mA LED Driver (Eight White LEDs per Channel)

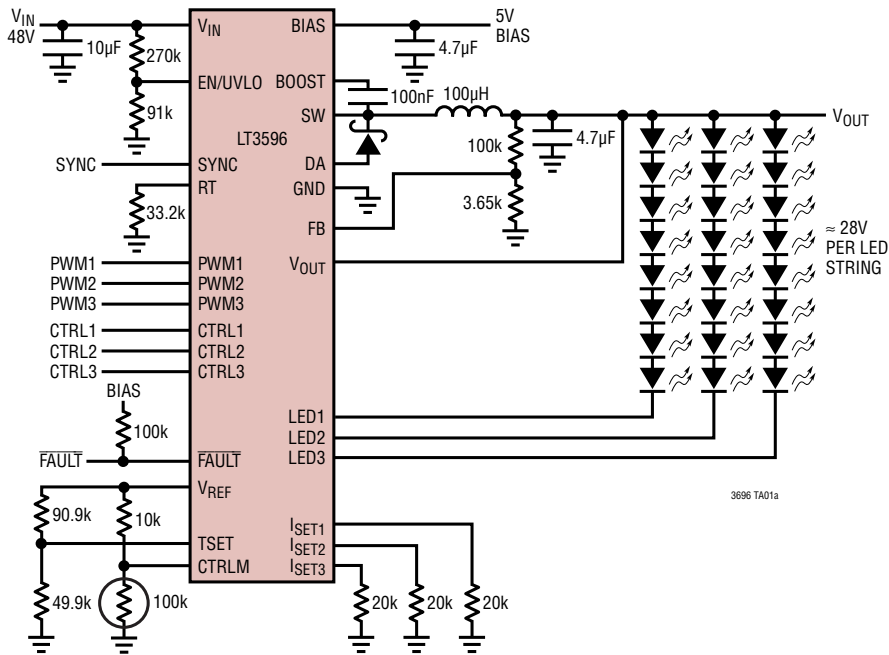

10,000:1 PWM Dimming at 100Hz

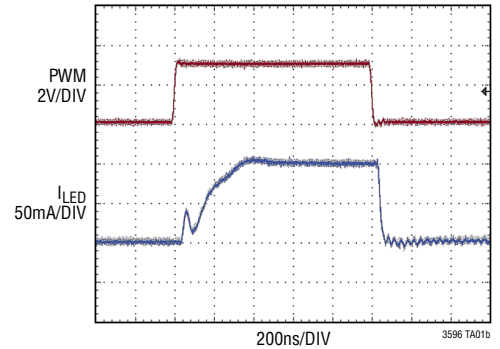

## RELATED PARTS

PART NUMBER	DESCRIPTION	COMMENTS
LT3476	Quad Output 1.5A, 2MHz High Current LED Driver with 1000:1 Dimming	$V_{IN}$ : 2.8V to 16V, $V_{OUT(MAX)}$ = 36V, True Color PWM Dimming = 1000:1, $I_{SD} < 10\mu A$ , 5mm $\times$ 7mm QFN-10 Package
LT3496	45V, 2.1MHz 3-Channel ( $I_{LED} = 1A$ ) Full-Featured LED Driver	$V_{IN}$ : 3V to 30V (40V <sub>MAX</sub> ), $V_{OUT(MAX)}$ = 45V, True Color PWM Dimming = 3000:1, $I_{SD} < 1\mu A$ , 4mm $\times$ 3mm QFN-28 Package
LT3590	48V, 850kHz 50mA Buck Mode LED Driver	$V_{IN}$ : 4.5V to 55V, True Color PWM Dimming = 200:1, $I_{SD} < 15\mu A$ , 2mm $\times$ 2mm DFN-6 and SC70 Packages
LT3595	45V, 2MHz 16-Channel Full-Featured LED Driver	$V_{IN}$ : 4.5V to 55V, $V_{OUT(MAX)}$ = 45V True Color PWM Dimming = 5000:1, $I_{SD} < 1\mu A$ , 5mm $\times$ 9mm QFN-56 Package
LT3598	44V, 1.5A, 2.5MHz Boost 6-Channel LED Driver	$V_{IN}$ : 3V to 30V (40V <sub>MAX</sub> ), $V_{OUT(MAX)}$ = 44V, True Color PWM Dimming = 1000:1, $I_{SD} < 1\mu A$ , 4mm $\times$ 4mm QFN-24 Package
LT3599	2A Boost Converter with Internal 4-String 150mA LED Ballaster	$V_{IN}$ : 3V to 30V, $V_{OUT(MAX)}$ = 44V, True Color PWM Dimming = 1000:1, $I_{SD} < 1\mu A$ , 5mm $\times$ 5mm QFN-32 and TSSOP-28 Packages
LT3754	16-Channel $\times$ 50mA LED Driver with 60V Boost Controller and PWM Dimming	$V_{IN}$ : 6V to 40V, $V_{OUT(MAX)}$ = 45V, True Color PWM Dimming = 3000:1, $I_{SD} < 1\mu A$ , 5mm $\times$ 5mm QFN-32 Package

# Mouser Electronics

Authorized Distributor

Click to View Pricing, Inventory, Delivery & Lifecycle Information:

[Analog Devices Inc.:](#)

[LT3596EUHG#PBF](#) [LT3596IUHG#TRPBF](#) [LT3596EUHG#TRPBF](#) [LT3596IUHG#PBF](#)