



ANT-868-MHW

868 MHz Helical Dipole LPWA Antenna

MHW series antennas are durable remote-mount adhesive-backed dipole antennas that can be attached permanently to a variety of non-conductive surfaces such as windows, drywall, ceiling tiles, and most plastic surfaces.

Providing excellent performance for low-power, wide-area (LPWA) wireless applications, the MHW series antennas are available with either, 2.0 m (78.7 in) or 4.6 m (181.1 in) of RG-174 coaxial cable terminated in an SMA plug (male pin) connector.

FEATURES

- Performance summary
 - VSWR: ≤ 1.3
 - Peak Gain: 4.0
 - Efficiency: 54%
- Omnidirectional pattern
- Rugged & damage-resistant
- Durable adhesive backing
- Available with 2.0 m or 4.6 m of RG-174 coaxial cable
- SMA plug (male pin) connector

APPLICATIONS

- Low-power, wide-area (LPWA) applications
 - LoRaWAN®
 - Sigfox®
- Remote sensing, monitoring and control
 - Security systems
 - Industrial machinery
- Internet of Things (IoT) devices

ORDERING INFORMATION

Part Number	Description
ANT-868-MHW-SMA-L	4.6 m (181.1 in) RG-174 coax cable terminated in an SMA plug (male pin)
ANT-868-MHW-SMA-S	2.0 m (78.7 in) RG-174 coax cable terminated in an SMA plug (male pin)

Available from Linx Technologies and select distributors and representatives.

ELECTRICAL SPECIFICATIONS

ANT-868-MHW	862 MHz to 876 MHz
VSWR (max)	1.3
Peak Gain (dBi)	4.0
Average Gain (dBi)	-2.8
Efficiency (%)	54
Polarization	Linear
Radiation	Omnidirectional
Max Power	10 W
Wavelength	1/2-wave
Electrical Type	Dipole
Impedance	50 Ω
Cable	2.0 m (78.7 in) or 4.6 m (181.1 in) of RG-174 coaxial cable
Connection	SMA plug (male pin)
Weight	ANT-868-MHW-SMA-S: 44.0 g (1.60 oz)
Dimensions	ANT-868-MHW-SMA-L: 76.5 g (2.70 oz)
Operating Temperature Range	138.0 mm x 15.5 mm x 9.2 mm (5.43 in x 0.61 x 0.36 in)
ESD Sensitivity	-20 °C to +70 °C

PACKAGING INFORMATION

ANT-868-MHW antennas are packed in a clear plastic labeled bag, 25 antennas per bag for "-L" antennas, and 50 antennas per bag for "-S" antennas. Distribution channels may offer alternative packaging options.

PRODUCT DIMENSIONS

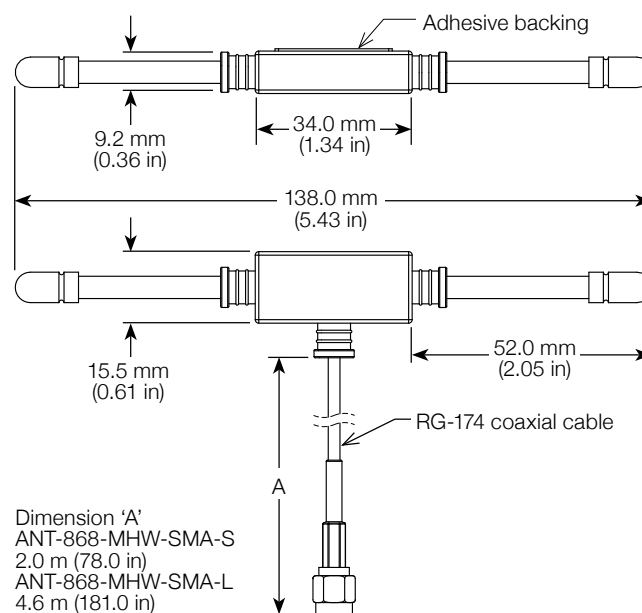

Figure 1. ANT-868-MHW Dimensions

VSWR

Figure 2 provides the voltage standing wave ratio (VSWR) across the antenna bandwidth. VSWR describes the power reflected from the antenna back to the radio. A lower VSWR value indicates better antenna performance at a given frequency. Reflected power is also shown on the right-side vertical axis as a gauge of the percentage of transmitter power reflected back from the antenna.

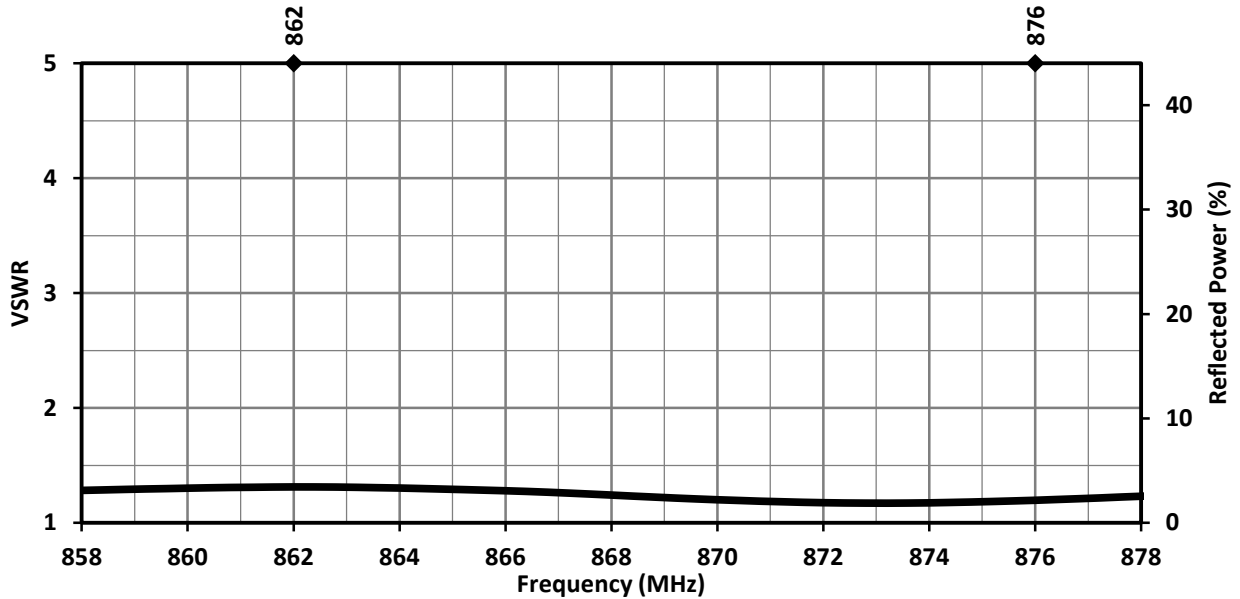

Figure 2. 868-CPA VSWR

RETURN LOSS

Return loss (Figure 3), represents the loss in power at the antenna due to reflected signals. Like VSWR, a lower return loss value indicates better antenna performance at a given frequency.

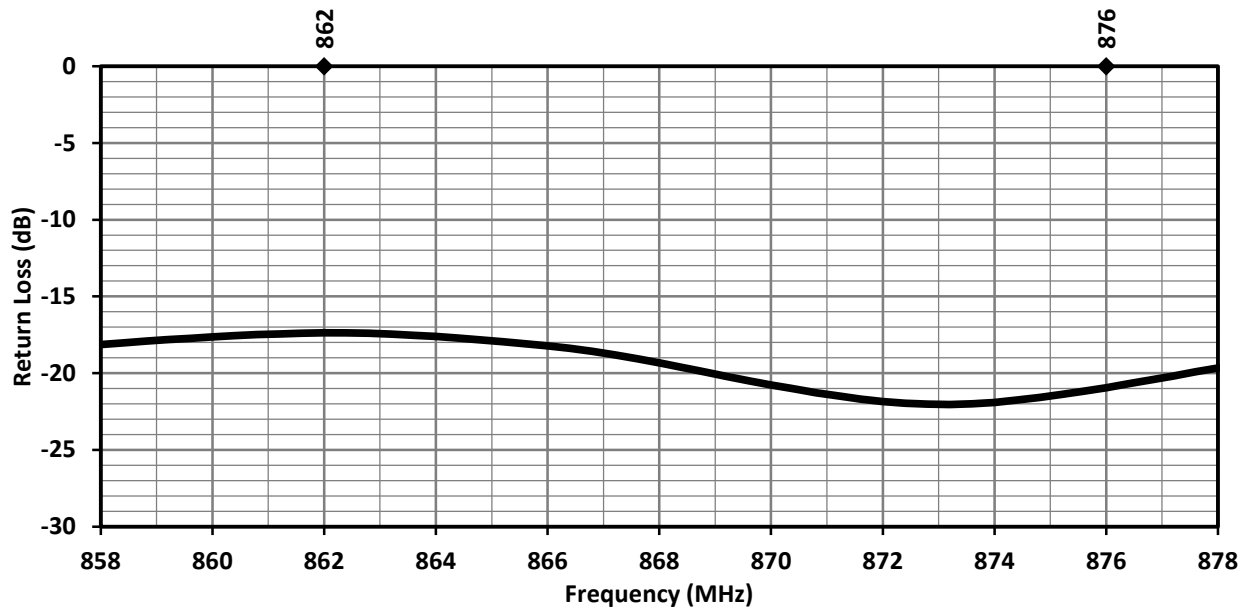

Figure 3. ANT-868-MHW Antenna Return Loss

PEAK GAIN

The peak gain across the antenna bandwidth is shown in Figure 4. Peak gain represents the maximum antenna input power concentration across 3-dimensional space, and therefore peak performance, at a given frequency, but does not consider any directionality in the gain pattern.

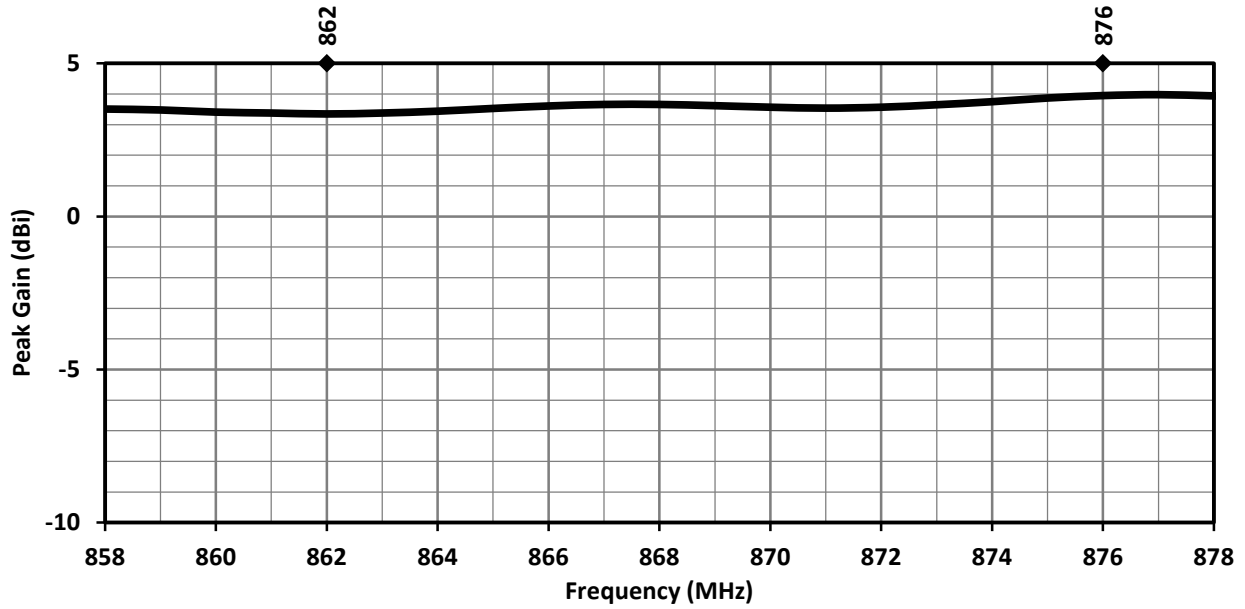

Figure 4. ANT-868-MHW Antenna Peak Gain

AVERAGE GAIN

Average gain (Figure 5), is the average of all antenna gain in 3-dimensional space at each frequency, providing an indication of overall performance without expressing antenna directionality

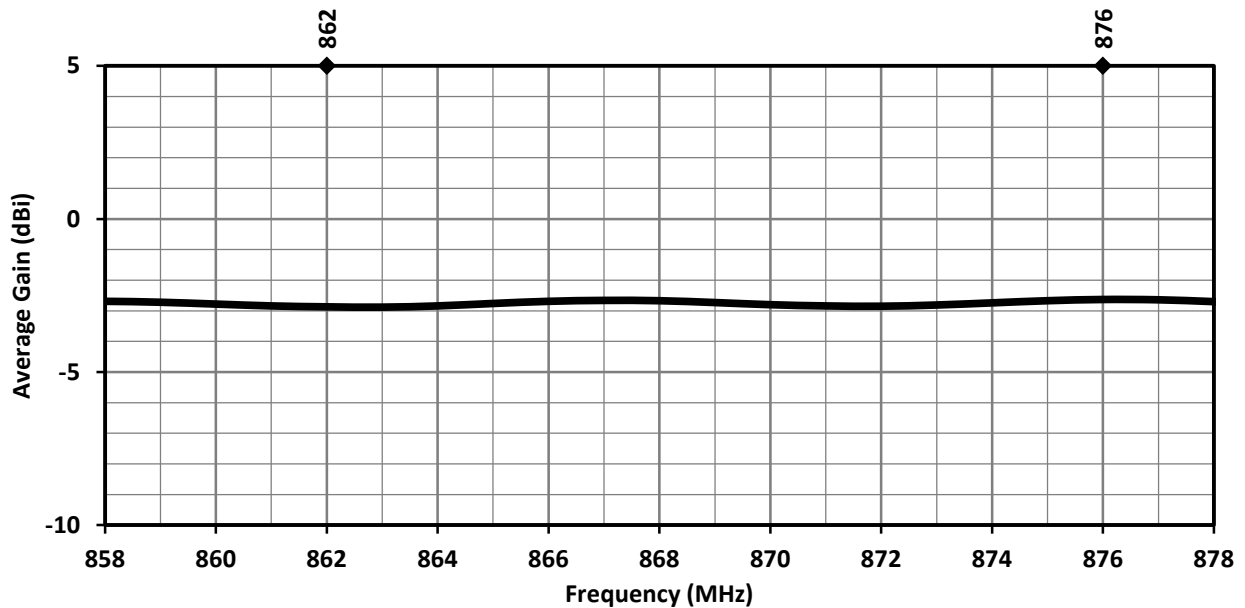

Figure 5. ANT-868-MHW Antenna Average Gain

RADIATION EFFICIENCY

Radiation efficiency (Figure 6), shows the ratio of power delivered to the antenna relative to the power radiated at the antenna, expressed as a percentage, where a higher percentage indicates better performance at a given frequency.

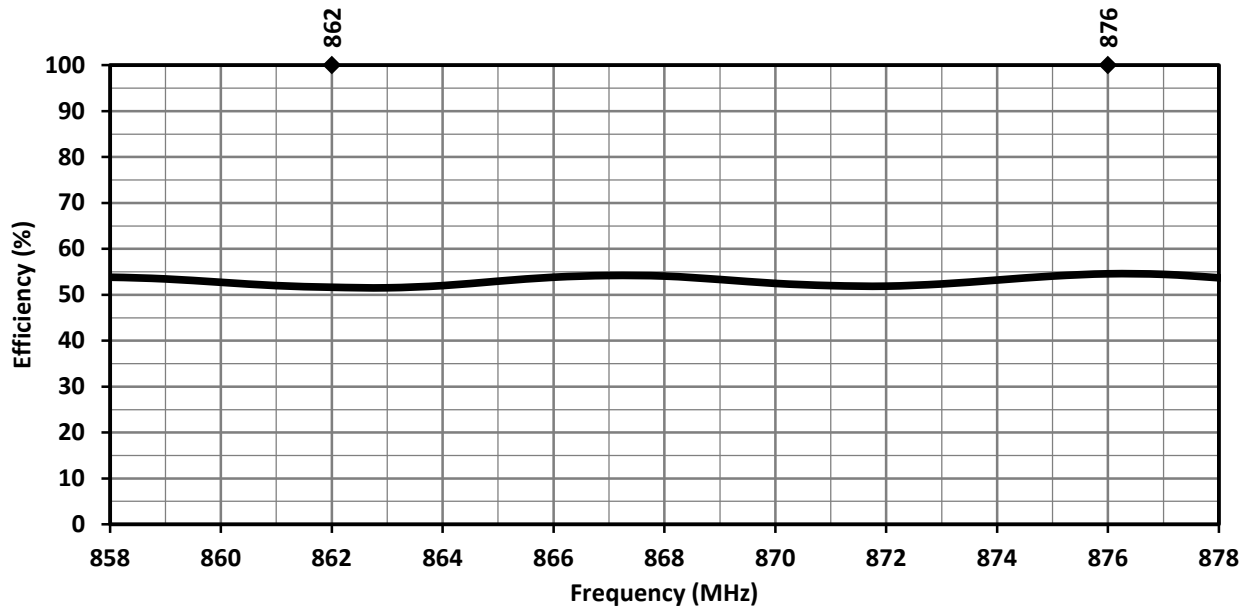

Figure 6. ANT-868-MHW Antenna Radiation Efficiency

RADIATION PATTERNS

Radiation patterns provide information about the directionality and 3-dimensional gain performance of the antenna by plotting gain at specific frequencies in three orthogonal planes. Antenna radiation patterns (Figure 7), are shown using polar plots covering 360 degrees. The antenna graphic above the plots provides reference to the plane of the column of plots below it. Note: when viewed with typical PDF viewing software, zooming into radiation patterns is possible to reveal fine detail.



XZ-Plane Gain



YZ-Plane Gain

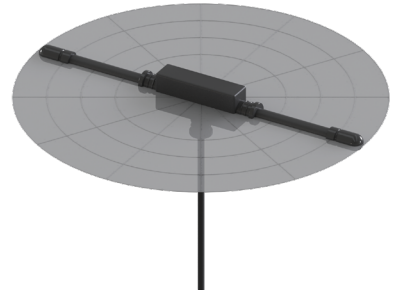

XY-Plane Gain

862 MHZ TO 876 MHZ (868 MHZ)

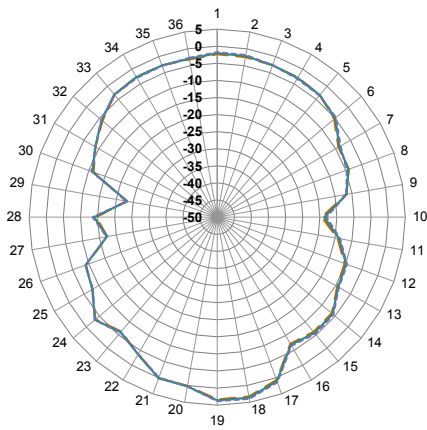

XZ-Plane Gain

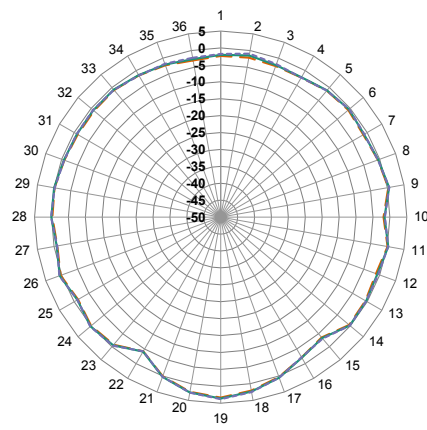

YZ-Plane Gain

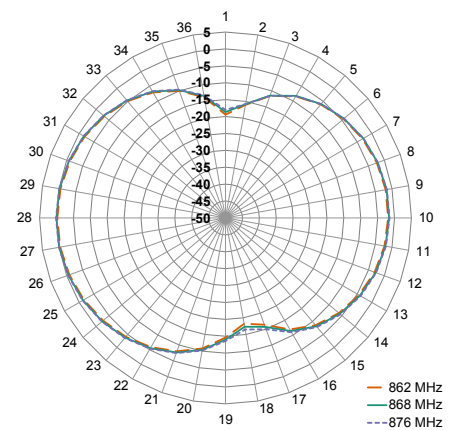

XY-Plane Gain

Figure 7. Radiation Patterns for ANT-868-MHW Antenna

ANTENNA DEFINITIONS AND USEFUL FORMULAS

VSWR - Voltage Standing Wave Ratio. VSWR is a unitless ratio that describes the power reflected from the antenna back to the radio. A lower VSWR value indicates better antenna performance at a given frequency. VSWR is easily derived from Return Loss.

$$\text{VSWR} = \frac{10^{\left[\frac{\text{Return Loss}}{20}\right]} + 1}{10^{\left[\frac{\text{Return Loss}}{20}\right]} - 1}$$

Return Loss - Return loss represents the loss in power at the antenna due to reflected signals, measured in decibels. A lower return loss value indicates better antenna performance at a given frequency. Return Loss is easily derived from VSWR.

$$\text{Return Loss} = -20 \log_{10} \left[\frac{\text{VSWR} - 1}{\text{VSWR} + 1} \right]$$

Efficiency (η) - The total power radiated from an antenna divided by the input power at the feed point of the antenna as a percentage.

Total Radiated Efficiency - (TRE) The total efficiency of an antenna system comprising the radiation efficiency of the antenna and the transmitted (forward) efficiency from the transmitter.

$$\text{TRE} = \eta \cdot \left(1 - \left(\frac{\text{VSWR} - 1}{\text{VSWR} + 1} \right)^2 \right)$$

Gain - The ratio of an antenna's efficiency in a given direction (G) to the power produced by a theoretical lossless (100% efficient) isotropic antenna. The gain of an antenna is almost always expressed in decibels.

$$G_{\text{db}} = 10 \log_{10}(G)$$

$$G_{\text{dBd}} = G_{\text{dBi}} - 2.51\text{dB}$$

Peak Gain - The highest antenna gain across all directions for a given frequency range. A directional antenna will have a very high peak gain compared to average gain.

Average Gain - The average gain across all directions for a given frequency range.

Maximum Power - The maximum signal power which may be applied to an antenna feed point, typically measured in watts (W).

Reflected Power - A portion of the forward power reflected back toward the amplifier due to a mismatch at the antenna port.

$$\left(\frac{\text{VSWR} - 1}{\text{VSWR} + 1} \right)^2$$

decibel (dB) - A logarithmic unit of measure of the power of an electrical signal.

decibel isotropic (dBi) - A comparative measure in decibels between an antenna under test and an isotropic radiator.

decibel relative to a dipole (dBd) - A comparative measure in decibels between an antenna under test and an ideal half-wave dipole.

Dipole - An ideal dipole comprises a straight electrical conductor measuring 1/2 wavelength from end to end connected at the center to a feed point for the radio.

Isotropic Radiator - A theoretical antenna which radiates energy equally in all directions as a perfect sphere.

Omnidirectional - Term describing an antenna radiation pattern that is uniform in all directions. An isotropic antenna is the theoretical perfect omnidirectional antenna. An ideal dipole antenna has a donut-shaped radiation pattern and other practical antenna implementations will have less perfect but generally omnidirectional radiation patterns which are typically plotted on three axes.

TE TECHNICAL SUPPORT CENTER

USA:	+1 (800) 522-6752
Canada:	+1 (905) 475-6222
Mexico:	+52 (0) 55-1106-0800
Latin/S. America:	+54 (0) 11-4733-2200
Germany:	+49 (0) 6251-133-1999
UK:	+44 (0) 800-267666
France:	+33 (0) 1-3420-8686
Netherlands:	+31 (0) 73-6246-999
China:	+86 (0) 400-820-6015

te.com

TE Connectivity, TE, TE connectivity (logo), Linx and Linx Technologies are trademarks owned or licensed by the TE Connectivity Ltd. family of companies. All other logos, products and/or company names referred to herein might be trademarks of their respective owners.

The information given herein, including drawings, illustrations and schematics which are intended for illustration purposes only, is believed to be reliable. However, TE Connectivity makes no warranties as to its accuracy or completeness and disclaims any liability in connection with its use. TE Connectivity's obligations shall only be as set forth in TE Connectivity's Standard Terms and Conditions of Sale for this product and in no case will TE Connectivity be liable for any incidental, indirect or consequential damages arising out of the sale, resale, use or misuse of the product. Users of TE Connectivity products should make their own evaluation to determine the suitability of each such product for the specific application.

TE Connectivity warrants to the original end user customer of its products that its products are free from defects in material and workmanship. Subject to conditions and limitations TE Connectivity will, at its option, either repair or replace any part of its products that prove defective because of improper workmanship or materials. This limited warranty is in force for the useful lifetime of the original end product into which the TE Connectivity product is installed. Useful lifetime of the original end product may vary but is not warranted to exceed one (1) year from the original date of the end product purchase.

©2022 TE Connectivity. All Rights Reserved.

11/22 Original

Mouser Electronics

Authorized Distributor

Click to View Pricing, Inventory, Delivery & Lifecycle Information:

[TE Connectivity:](#)

[ANT-868-MHW-SMA-L](#)