



80x80x38 mm

San Ace 80 9GA type Low Power Consumption Fan

General Specifications

- Material Frame: Plastic (Flammability: UL 94V-0), Impeller: Plastic (Flammability: UL 94V-0)
- Expected life See the table below. (L10 life: 90% survival rate for continuous operation in free air at 60°C, rated voltage) Expected life at 40°C is for reference only.
- Motor protection function Locked rotor burnout protection, Reverse polarity protection For details, please refer to p. 580.
- Dielectric strength 50/60 Hz, 500 VAC, for 1 minute (between lead wire conductors and frame)
- Insulation resistance 10 MΩ min. at 500 VDC (between lead wire conductors and frame)
- Sound pressure level (SPL) A-weighted sound pressure level (SPL) at 1 m away from the air inlet.
- Storage temperature -30 to +70°C (Non-condensing)
- Lead wire ⊕Red ⊖Black Sensor Yellow Control Brown
- Mass 160 g

Specifications

The models listed below **have ribs and pulse sensors with PWM control function.** For models without ribs, append "1" to the end of model numbers.

Model no.	Rated voltage [V]	Operating voltage range [V]	PWM duty cycle [%]	Rated current [A]	Rated input [W]	Rated speed [min ⁻¹]	Max. airflow [m ² /min] [CFM]	Max. static pressure [Pa] [inchH ₂ O]	SPL [dB (A)]	Operating temperature [°C]	Expected life [h]			
9GA0812P1G61	12	10.8 to 13.2	100	1.2	14.4	10500	2.85 100.6	480 1.93	60	-20 to +70	40000/60°C (70000/40°C)			
			0	0.07	0.48	2000	0.51 18.0	28.7 0.11	21					
9GA0812P1S61			100	0.94	11.28	9550	2.6 91.8	480 1.93	59					
			0	0.1	1.2	2900	0.74 26.1	60 0.24	27					
9GA0812P1H61			100	0.6	7.2	8250	2.25 79.4	380 1.53	55					
			0	0.08	0.96	2500	0.64 22.6	45 0.18	24					
9GA0824P1S61		24	20.4 to 27.6	100	0.47	11.28	9550	2.6 91.8	480 1.93			59		
				0	0.06	1.44	2900	0.74 26.1	60 0.24			27		
9GA0824P1H61				100	0.3	7.2	8250	2.25 79.4	380 1.53			55		
				0	0.05	1.2	2500	0.64 22.6	45 0.18			24		
9GA0848P1S61				48	40.8 to 55.2	100	0.25	12	9550			2.6 91.8	480 1.93	59
						0	0.04	1.92	2900			0.74 26.1	60 0.24	27

* PWM frequency is 25 kHz. Models without ratings for 0% PWM duty cycle have zero speed at 0%. When control terminal is open, speed is the same as at 100% duty cycle.

Note 1: Sensor and control options are available for selection. Refer to the table on pp. 608 to 609.

Note 2: The mark indicates Short LeadTime Service applicable models. See p. 630 for details.

Airflow - Static Pressure Characteristics / PWM Duty - Speed Characteristics Example

9GA0812P1G61 With pulse sensor with PWM control function

PWM duty cycle

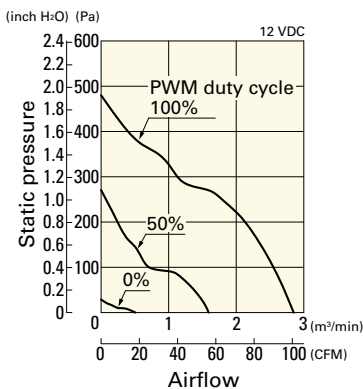

Operating voltage range

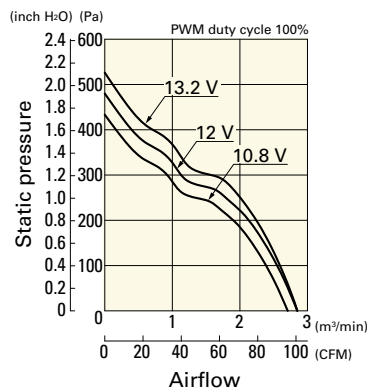

PWM duty - Speed characteristics example

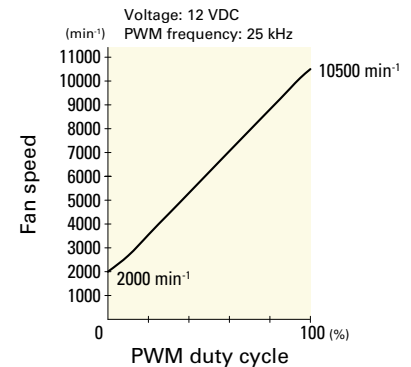

Airflow - Static Pressure Characteristics / PWM Duty - Speed Characteristics Example

9GA0812P1S61 With pulse sensor with PWM control function

PWM duty cycle

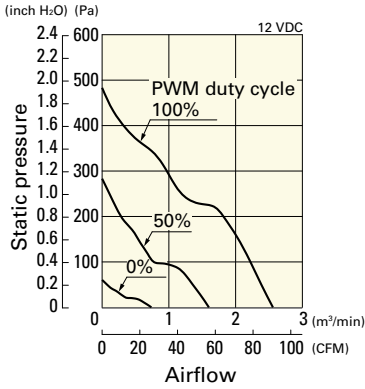

Operating voltage range

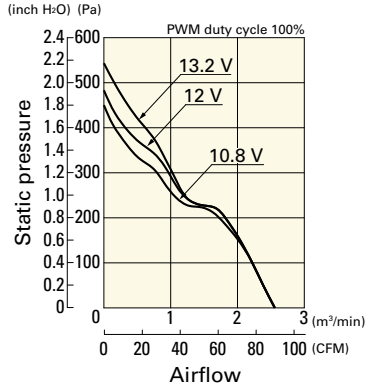

PWM duty - Speed characteristics example

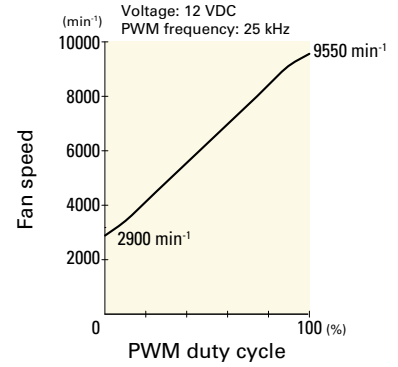

9GA0812P1H61 With pulse sensor with PWM control function

PWM duty cycle

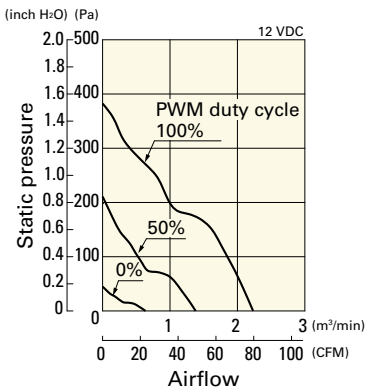

Operating voltage range

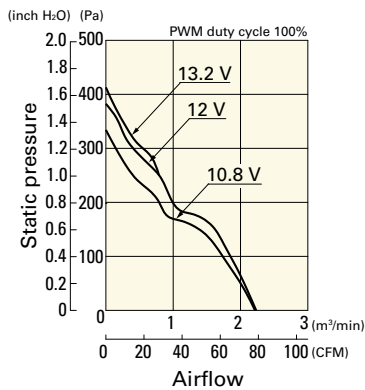

PWM duty - Speed characteristics example

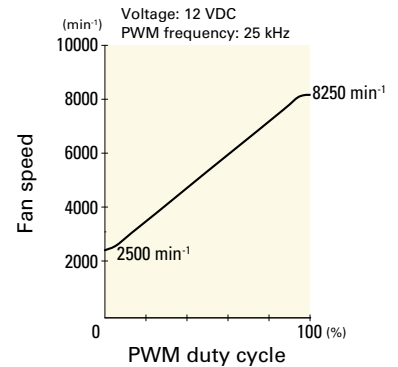

9GA0824P1S61 With pulse sensor with PWM control function

PWM duty cycle

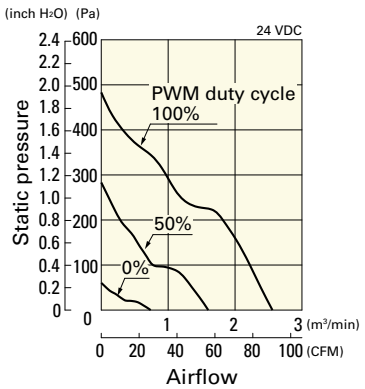

Operating voltage range

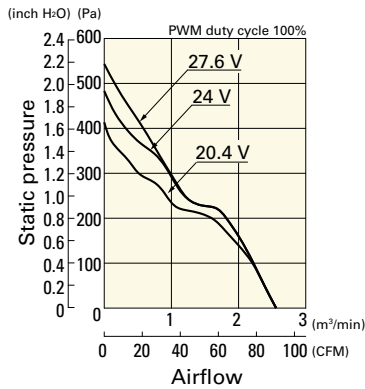

PWM duty - Speed characteristics example

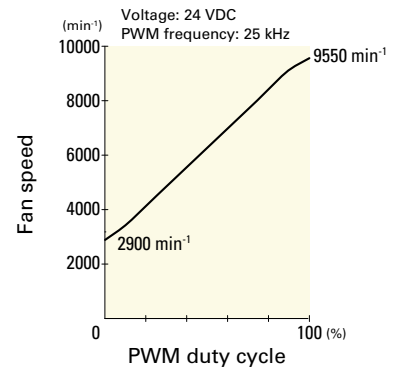

9GA0824P1H61 With pulse sensor with PWM control function

PWM duty cycle

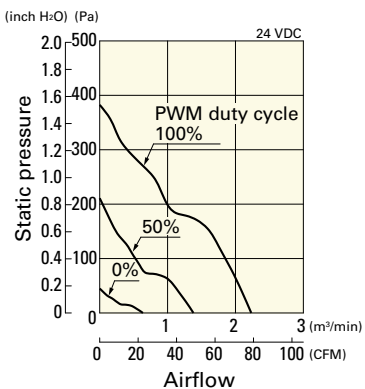

Operating voltage range

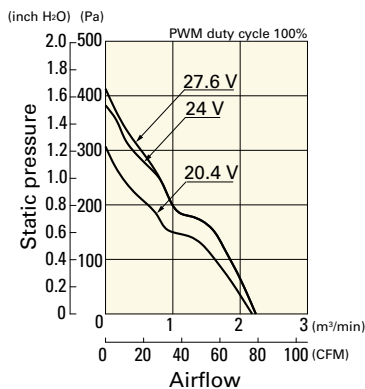

PWM duty - Speed characteristics example

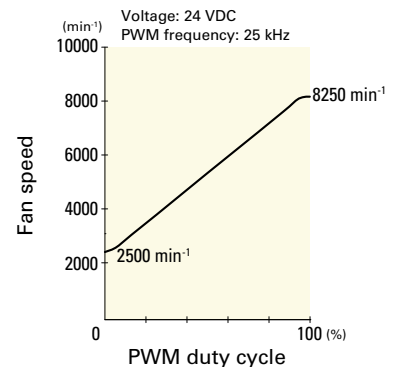

Airflow - Static Pressure Characteristics / PWM Duty - Speed Characteristics Example

9GA0848P1S61 With pulse sensor with PWM control function

PWM duty cycle

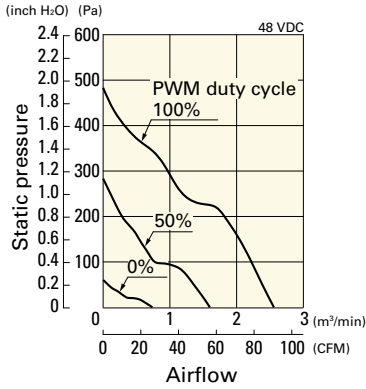

Operating voltage range

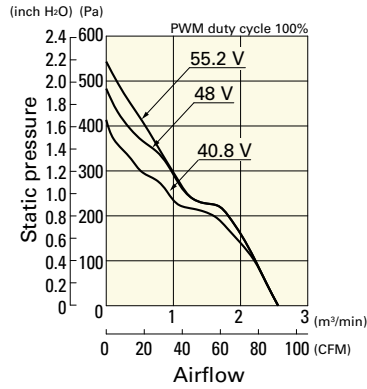

PWM duty - Speed characteristics example

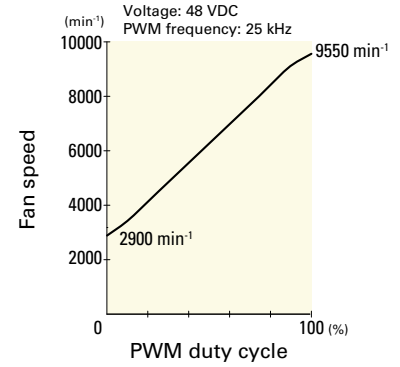

Dimensions (unit: mm) (With ribs)

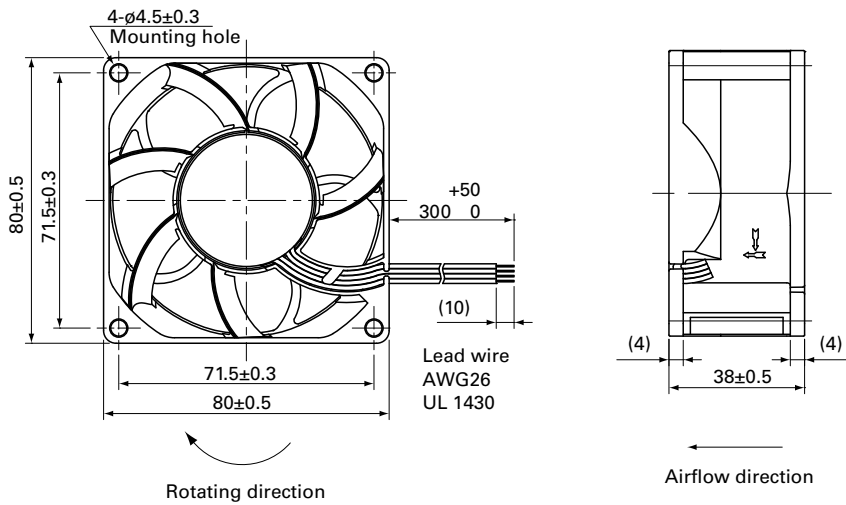

Reference Dimensions of Mounting Holes and Vent Opening (unit: mm)

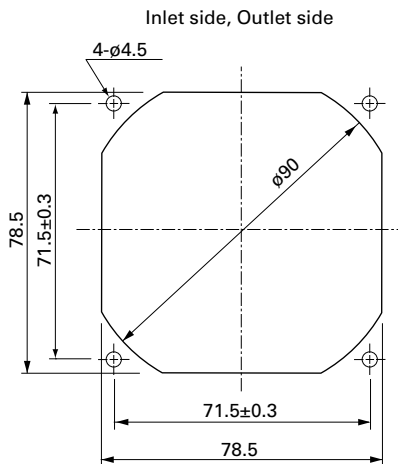

Options

Finger guards

page: p. 564

Model no.: 109-049E, 109-049H, 109-049C

Resin finger guards

page: p. 571

Model no.: 109-1002G

Resin filter kits

page: p. 572

Model no.: 109-1002F13 (13PPI), 109-1002F20 (20PPI),
109-1002F30 (30PPI), 109-1002F40 (40PPI)