



# LED Display Product Data Sheet LTD-5623AG

Spec No.: DS-30-97-033

Effective Date: 05/06/2000

Revision: -

**LITE-ON DCC**

**RELEASE**

BNS-OD-FC001/A4

**FEATURES**

- \* 0.56INCH (14.22mm) DIGIT HEIGHT
- \* CONTINUOUS UNIFORM SEGMENTS
- \* LOW POWER REQUIREMENT
- \* EXCELLENT CHARACTERS APPEARANCE
- \* HIGH BRIGHTNESS & HIGH CONTRAST
- \* WIDE VIEWING ANGLE
- \* SOLID STATE RELIABILITY
- \* CATEGORIZED FOR LUMINOUS INTENSITY

**DESCRIPTION**

The LTD-5623AG is a 0.56inch (14.22mm) digit height dual digit seven-segment display. The device utilizes green LED chips, which are made from GaP on a transparent GaP substrate, and has a gray face and green segments.

**DEVICE**

PART NO.	DESCRIPTION
GREEN	COMMON CATHODE
LTD-5623AG	RT. HAND DECIMAL

## PACKAGE DIMENSIONS

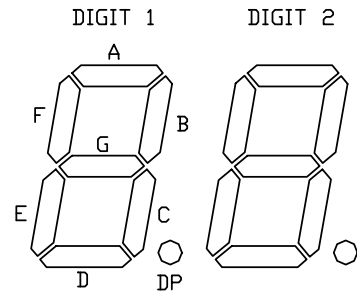
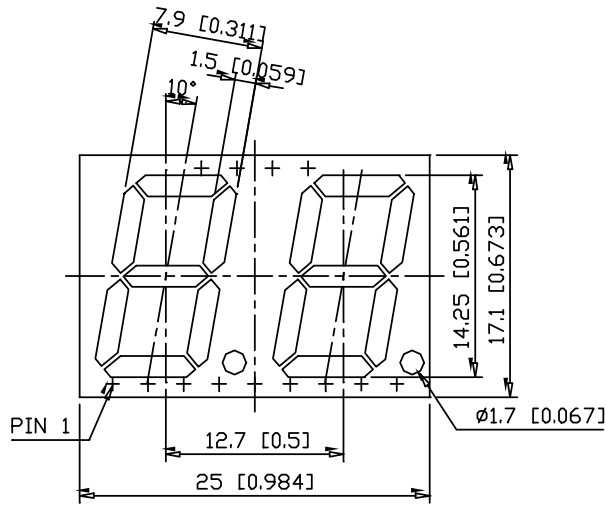

PART NO.  
DATE CODE  
BIN CODE

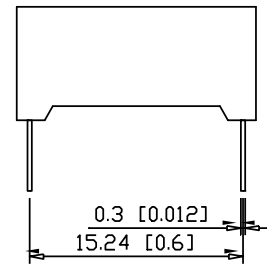
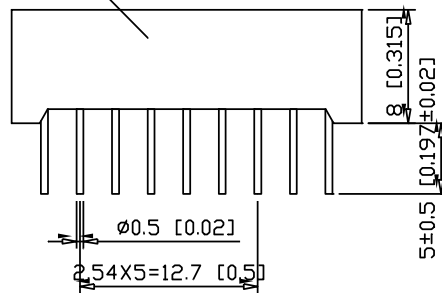

NOTES: All dimensions are in millimeters. Tolerances are ± 0.25 mm unless otherwise noted.

## INTERNAL CIRCUIT DIAGRAM

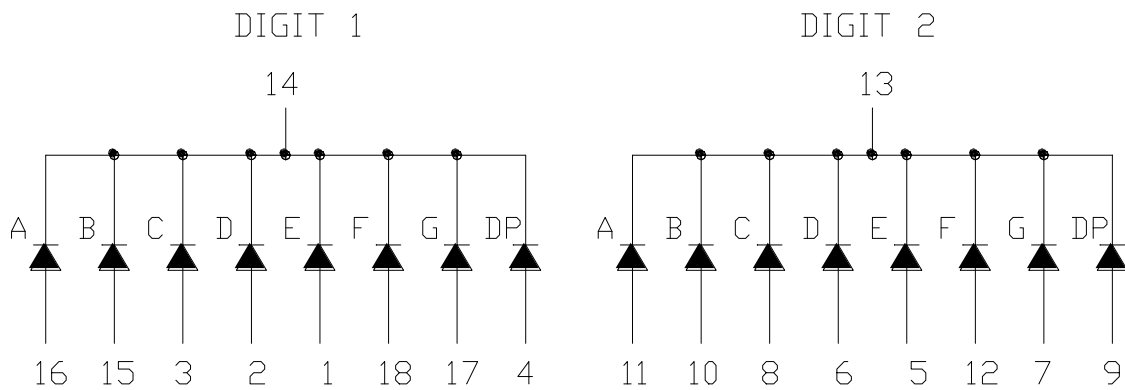

**PIN CONNECTION**

<b>No.</b>	<b>CONNECTION</b>
1	ANODE E (DIGIT 1)
2	ANODE D (DIGIT 1)
3	ANODE C (DIGIT 1)
4	ANODE DP (DIGIT 1)
5	ANODE E (DIGIT 2)
6	ANODE D (DIGIT 2)
7	ANODE G (DIGIT 2)
8	ANODE C (DIGIT 2)
9	ANODE DP (DIGIT 2)
10	ANODE B (DIGIT 2)
11	ANODE A (DIGIT 2)
12	ANODE F (DIGIT 2)
13	COMMON CATHODE DIGIT 2
14	COMMON CATHODE DIGIT 1
15	ANODE B (DIGIT 1)
16	ANODE A (DIGIT 1)
17	ANODE G (DIGIT 1)
18	ANODE F (DIGIT 1)

**ABSOLUTE MAXIMUM RATING AT T<sub>A</sub>=25°C**

PARAMETER	MAXIMUM RATING	UNIT
Power Dissipation Per Chip	75	mW
Peak Forward Current Per Chip ( 1/10 Duty Cycle, 0.1ms Pulse Width )	100	mA
Continuous Forward Current Per Chip	25	mA
Derating Linear From 25°C Per Chip	0.33	mA/°C
Reverse Voltage Per Chip	5	V
Operating Temperature Range	-35°C to +85°C	
Storage Temperature Range	-35°C to +85°C	
Solder Temperature: max 260°C for max 3sec at 1.6mm below seating plane		

**TRICAL / OPTICAL CHARACTERISTICS AT T<sub>A</sub>=25°C**

PARAMETER	SYMBOL	MIN.	TYP.	MAX.	UNIT	TEST CONDITION
Average Luminous Intensity	I <sub>v</sub>	800	2400		μcd	I <sub>F</sub> =10mA
Peak Emission Wavelength	λ <sub>p</sub>		565		nm	I <sub>F</sub> =20mA
Spectral Line Half-Width	Δλ		30		nm	I <sub>F</sub> =20mA
Dominant Wavelength	λ <sub>d</sub>		569		nm	I <sub>F</sub> =20mA
Forward Voltage Per Chip	V <sub>F</sub>		2.1	2.6	V	I <sub>F</sub> =20mA
Reverse Current Per Chip	I <sub>R</sub>			100	μA	V <sub>R</sub> =5V
Luminous Intensity Matching Ratio	I <sub>v</sub> -m			2:1		I <sub>F</sub> =10mA

Note: Luminous intensity is measured with a light sensor and filter combination that approximates the CIE (Commision Internationale De L'Eclairage) eye-response curve.

**TYPICAL ELECTRICAL / OPTICAL CHARACTERISTIC CURVES**

(25°C Ambient Temperature Unless Otherwise Noted)

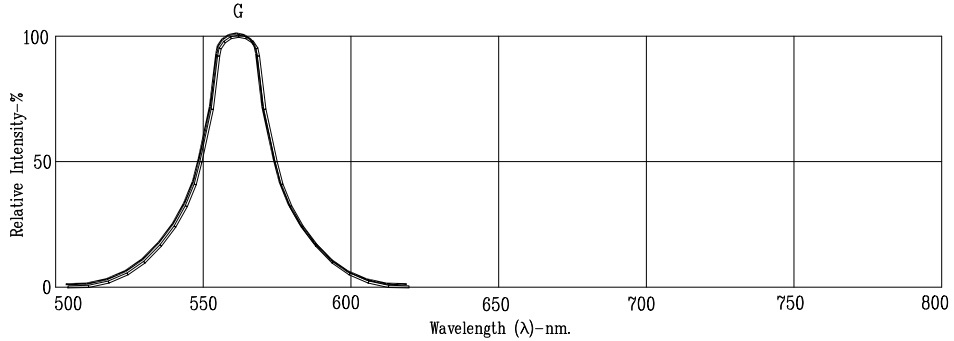

Fig1. RELATIVE INTENSITY VS. WAVELENGTH

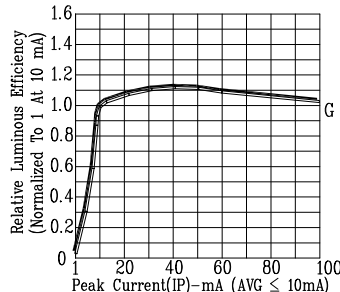

Fig2. RELATIVE LUMINOUS EFFICIENCY (LUMINOUS INTENSITY PER UNIT CURRENT) VS. PEAK CURRENT (REFRESH RATE 1KHz)

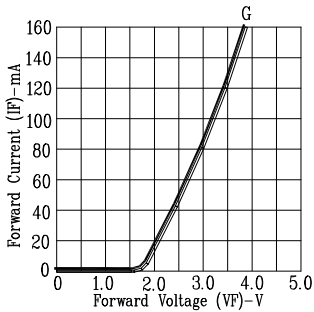

Fig3. FORWARD CURRENT VS. FORWARD VOLTAGE

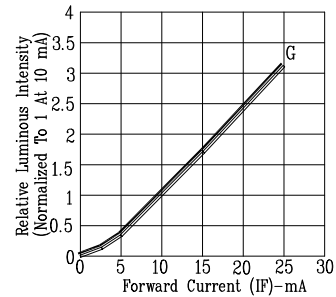

Fig4. RELATIVE LUMINOUS INTENSITY VS. FORWARD CURRENT

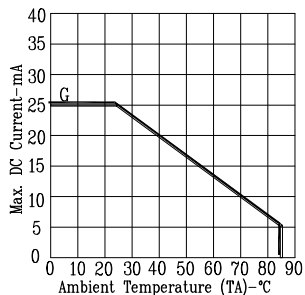

Fig5. MAX. ALLOWABLE DC CURRENT VS. AMBIENT TEMPERATURE.

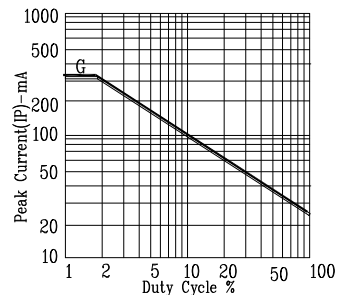

Fig6. MAX. PEAK CURRENT VS. DUTY CYCLE % (REFRESH RATE 1KHz)

NOTE: G=GREEN

# Mouser Electronics

Authorized Distributor

Click to View Pricing, Inventory, Delivery & Lifecycle Information:

[Lite-On:](#)

[LTD-5623AG](#)