

## 12 A 800 V Snubberless Triac in TO-220AB package

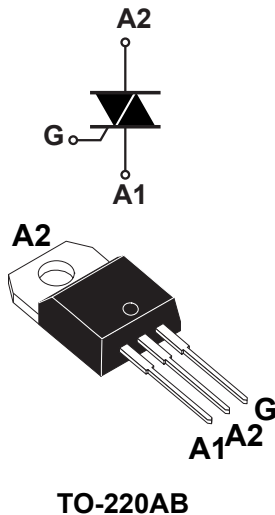

### Features

- Medium current Triac
- High static and dynamic commutation
- Three quadrants
- **ECOPACK2** compliant

### Applications

- General purpose AC line load switching
- Motor control circuits
- Small home appliances
- Lighting
- Inrush current limiting circuits
- Overvoltage crowbar protection

### Description

Available in through-hole package, the **T1235T-8T** Triac can be used for the on/off or phase angle control function in general purpose AC switching where high commutation capability is required.

This device can be used without a snubber circuit when the limits defined in this datasheet are respected.

#### Product status link

[T1235T-8T](#)

#### Product summary

<b>Order code</b>	T1235T-8T
<b>Package</b>	TO-220AB
<b><math>I_{T(RMS)}</math></b>	12 A
<b><math>V_{DRM}/V_{RRM}</math></b>	800 V
<b><math>V_{DSM}/V_{RSM}</math></b>	900 V
<b><math>I_{GT}</math></b>	35 mA

# 1 Characteristics

**Table 1. Absolute maximum ratings (limiting values)**

Symbol	Parameter		Value	Unit	
$I_{T(RMS)}$	On-state RMS current (full sine wave)		$T_c = 131\text{ °C}$	12	A
$I_{TSM}$	Non repetitive surge peak on-state current ( $T_j$ initial = 25 °C)	F = 50 Hz t = 20 ms	90	A	
		F = 60 Hz t = 16.7 ms	95		
$I^2t$	$I^2t$ value for fusing, ( $T_j$ initial = 25 °C)		$t_p = 10\text{ ms}$	54	A <sup>2</sup> s
$V_{DRM}/V_{RRM}$	Repetitive surge peak off-state voltage		$T_j = 150\text{ °C}$	600	V
			$T_j = 125\text{ °C}$	800	
$V_{DSM}/V_{RSM}$	Non repetitive surge peak off-state voltage		$t_p = 10\text{ ms}$	900	V
dI/dt	Critical rate of rise of on-state current $I_G = 2 \times I_{GT}$ , $tr \leq 100\text{ ns}$		F = 100 Hz	100	A/ $\mu$ s
$I_{GM}$	Peak gate current	$t_p = 20\text{ }\mu$ s	$T_j = 150\text{ °C}$	4	A
$P_{G(AV)}$	Average gate power dissipation		$T_j = 150\text{ °C}$	1	W
$T_{stg}$	Storage junction temperature range			-40 to +150	°C
$T_j$	Operating junction temperature range			-40 to +150	°C
$T_L$	Maximum lead temperature soldering during 10 s			260	°C

**Table 2. Electrical characteristics ( $T_j = 25\text{ °C}$  unless otherwise specified)**

Symbol	Test conditions		Value	Unit		
$I_{GT}^{(1)}$	$V_D = 12\text{ V}$ , $R_L = 30\text{ }\Omega$	I - II - III	Min.	1.75	mA	
			Max.	35		
$V_{GT}$	$V_D = 12\text{ V}$ , $R_L = 30\text{ }\Omega$	I - II - III	Max.	1.3	V	
$V_{GD}$	$V_D = V_{DRM}$ , $R_L = 3.3\text{ k}\Omega$ , $T_j = 150\text{ °C}$	I - II - III	Min.	0.2	V	
$I_H$	$I_T = 500\text{ mA}$		Max.	40	mA	
$I_L$	$I_G = 1.2 \times I_{GT}$	I - III	Max.	60	mA	
		II		65		
dV/dt <sup>(2)</sup>	$V_D = 536\text{ V}$ , gate open	$T_j = 125\text{ °C}$	Min.	2000	V/ $\mu$ s	
	$V_D = 402\text{ V}$ , gate open	$T_j = 150\text{ °C}$		1000		
(dI/dt) <sup>(2)</sup>	Without snubber (dV/dt) <sub>c</sub> > 20 V/ $\mu$ s		Min.	$T_j = 125\text{ °C}$	12	A/ms
				$T_j = 150\text{ °C}$	6	

1. Minimum  $I_{GT}$  is guaranteed at 5% of  $I_{GT}$  max.
2. For both polarities of A2 referenced to A1

**Table 3. Static characteristics**

Symbol	Test conditions			Value	Unit
$V_T^{(1)}$	$I_{TM} = 17 \text{ A}$ , $t_p = 380 \mu\text{s}$	$T_j = 25 \text{ }^\circ\text{C}$	Max.	1.55	V
$V_{TO}^{(1)}$	Threshold voltage	$T_j = 150 \text{ }^\circ\text{C}$	Max.	0.85	
$R_d^{(1)}$	Dynamic resistance	$T_j = 150 \text{ }^\circ\text{C}$	Max.	37	m $\Omega$
$I_{DRM}$ , $I_{RRM}$	$V_D = V_R = 800 \text{ V}$	$T_j = 25 \text{ }^\circ\text{C}$	Max.	7.5	$\mu\text{A}$
		$T_j = 125 \text{ }^\circ\text{C}$		1.0	mA
	$V_D = V_R = 600 \text{ V}$	$T_j = 150 \text{ }^\circ\text{C}$	Max.	2.7	

1. For both polarities of A2 referenced to A1

**Table 4. Thermal parameters**

Symbol	Parameter	Value	Unit
$R_{th(j-c)}$	Junction to case (AC)	1.3	$^\circ\text{C/W}$
$R_{th(j-a)}$	Junction to ambient	60	$^\circ\text{C/W}$

### 1.1 Characteristics curves

**Figure 1. Maximum power dissipation versus on-state RMS current (full cycle)**

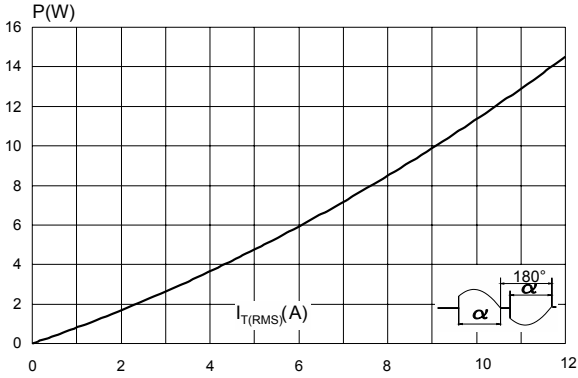

**Figure 2. On-state RMS current versus case temperature (full cycle)**

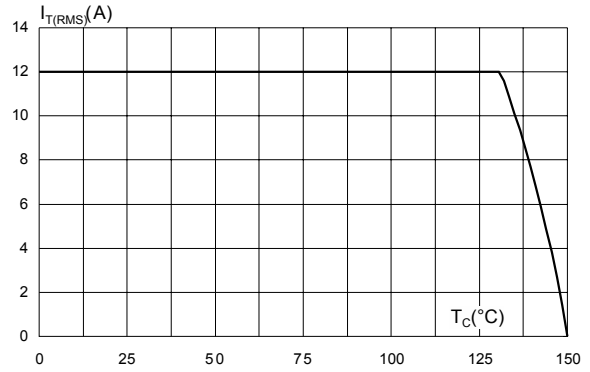

**Figure 3. On-state RMS current versus ambient temperature (free air convection)**

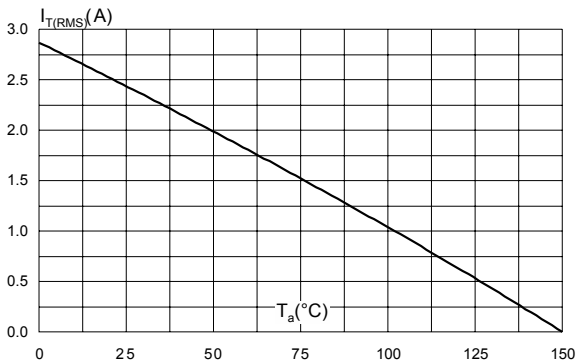

**Figure 4. Relative variation of thermal impedance versus pulse duration**

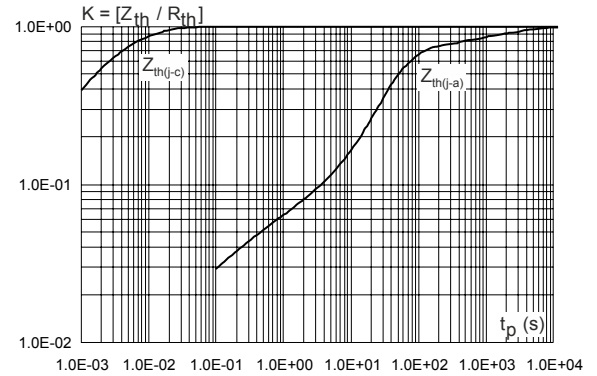

**Figure 5. On-state characteristics (maximum values)**

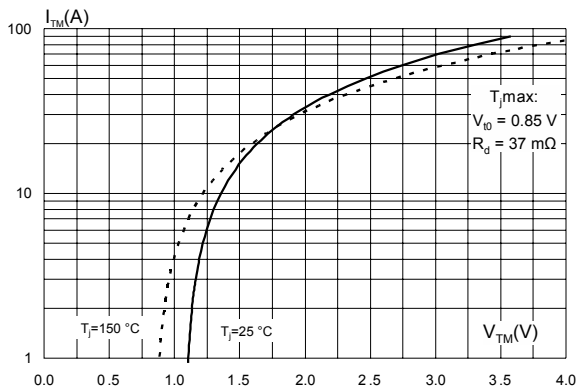

**Figure 6. Surge peak on-state current versus number of cycles**

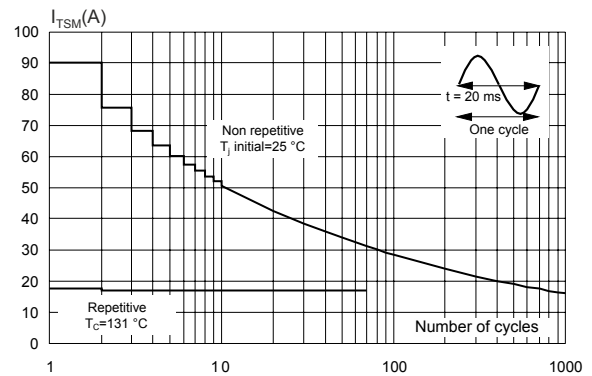

**Figure 7. Non repetitive surge peak on-state current**

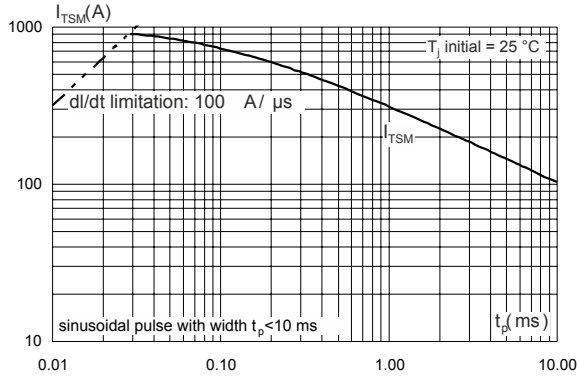

**Figure 8. Relative variation of gate trigger current and gate voltage versus junction temperature (typical values)**

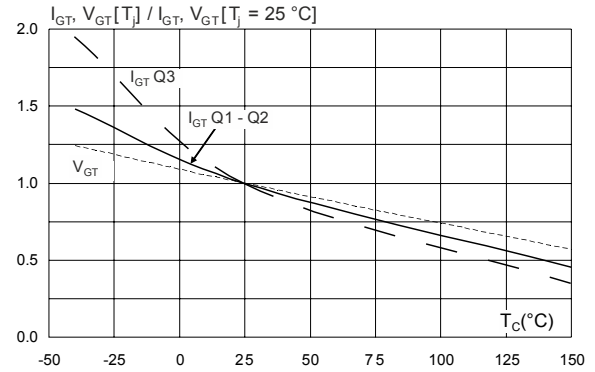

**Figure 9. Relative variation of static dV/dt immunity versus junction temperature (typical values)**

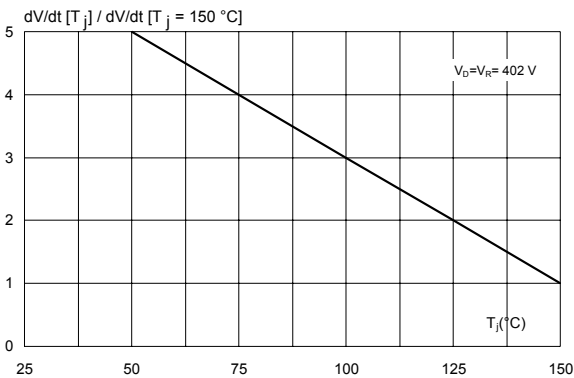

**Figure 10. Relative variation of holding current and latching current versus junction temperature (typical values)**

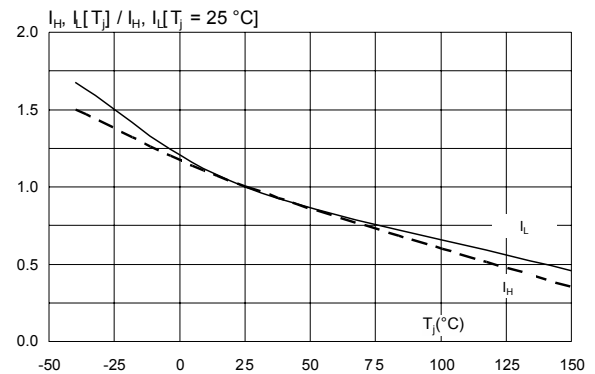

**Figure 11. Relative variation of critical rate of decrease of main current (di/dt)c versus reapplied (dV/dt)c (typical values)**

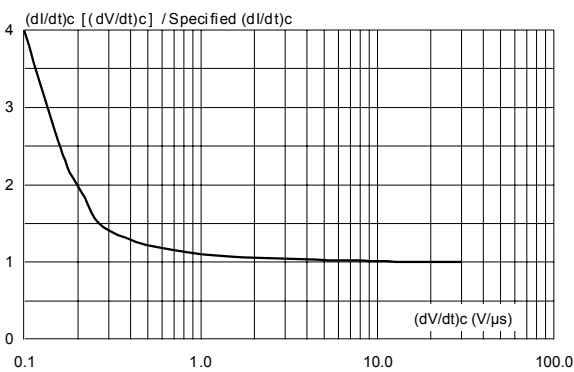

**Figure 12. Relative variation of critical rate of decrease of main current (di/dt)c versus junction temperature (typical values)**

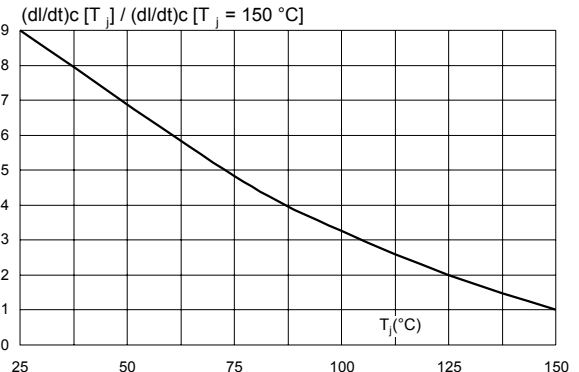
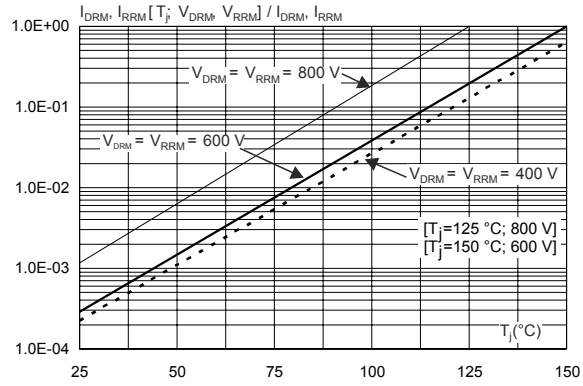

Figure 13. Relative variation of leakage current versus junction temperature for  $V_D = V_{DRM} / V_R = V_{RRM}$  blocking voltage (typical values)



## 2 Package information

In order to meet environmental requirements, ST offers these devices in different grades of **ECOPACK** packages, depending on their level of environmental compliance. ECOPACK specifications, grade definitions and product status are available at: [www.st.com](http://www.st.com). ECOPACK is an ST trademark.

### 2.1 TO-220AB package information

- Epoxy resin is halogen free and meets UL94 flammability standard, level V0
- Lead-free plating package leads
- Recommended torque: 0.4 to 0.6 N·m

Figure 14. TO-220AB package outline

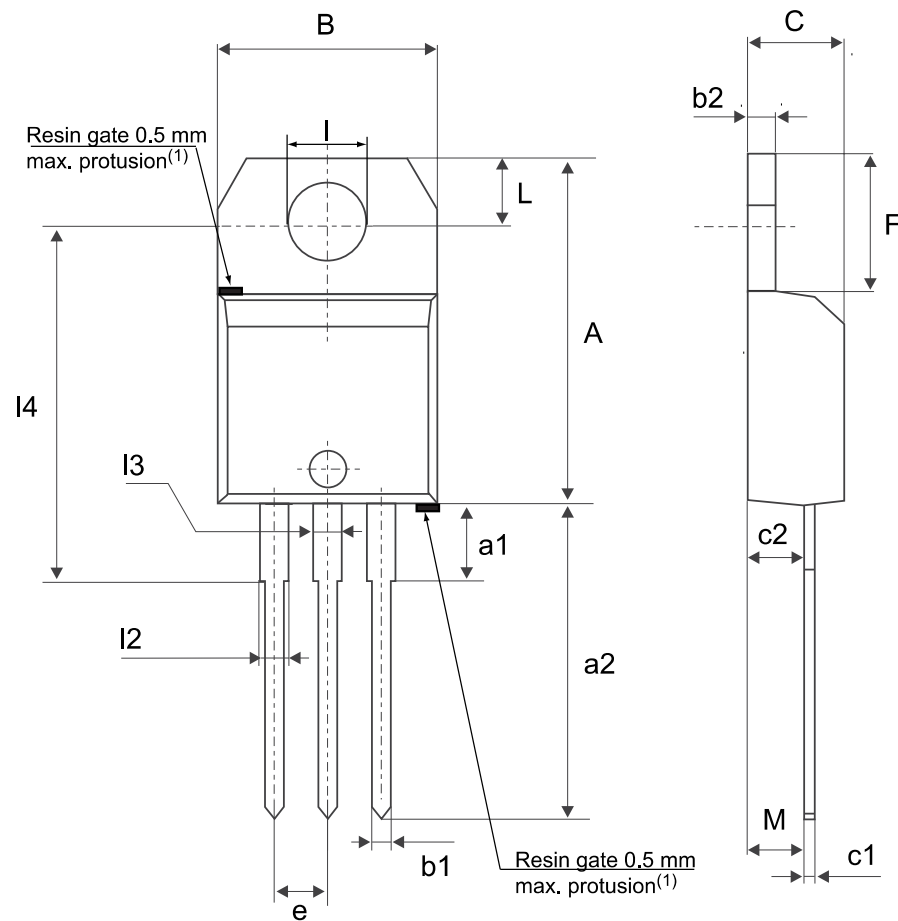

(1) Resin gate position accepted in one of the two positions or in the symmetrical opposites.

**Table 5. TO-220AB package mechanical data**

Ref.	Dimensions					
	Millimeters			Inches		
	Min.	Typ.	Max.	Min.	Typ.	Max.
A	15.20		15.90	0.5984		0.6260
a1		3.75			0.1476	
a2	13.00		14.00	0.5118		0.5512
B	10.00		10.40	0.3937		0.4094
b1	0.61		0.88	0.0240		0.0346
b2	1.23		1.32	0.0484		0.0520
C	4.40		4.60	0.1732		0.1811
c1	0.49		0.70	0.0193		0.0276
c2	2.40		2.72	0.0945		0.1071
e	2.40		2.70	0.0945		0.1063
F	6.20		6.60	0.2441		0.2598
I	3.73		3.88	0.1469		0.1528
L	2.65		2.95	0.1043		0.1161
I2	1.14		1.70	0.0449		0.0669
I3	1.14		1.70	0.0449		0.0669
I4	15.80	16.40	16.80	0.6220	0.6457	0.6614
M		2.6			0.1024	

1. Inch dimensions are for reference only.



### 3 Ordering information

Figure 15. Ordering information scheme

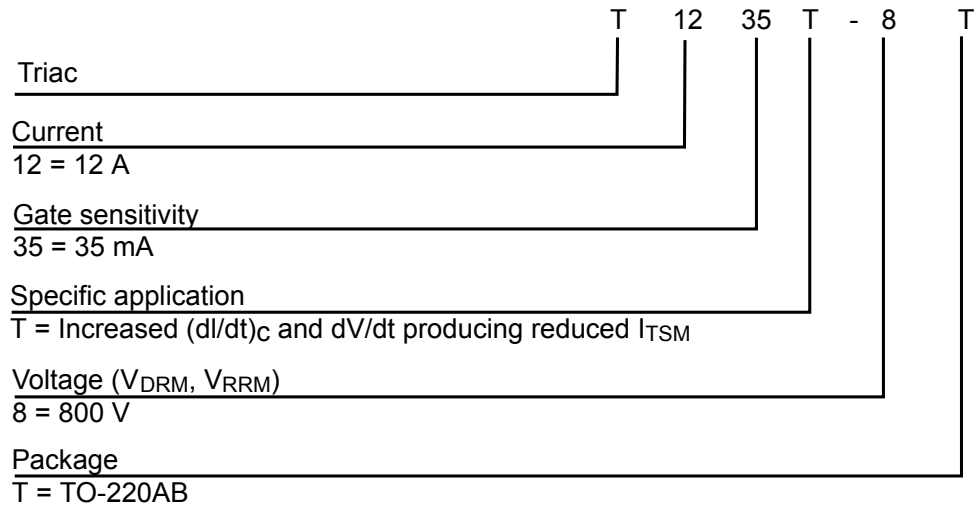

Table 6. Ordering information

Order code	Marking	Package	Weight	Base qty.	Delivery mode
T1235T-8T	T1235T-8T	TO-220AB	2.0 g	50	Tube

## Revision history

**Table 7. Document revision history**

Date	Revision	Changes
05-Aug-2013	1	Initial release.
01-Jul-2014	2	Updated Table 2.
28-Jul-2014	3	Updated Table 5.
13-Sep-2019	4	Updated <a href="#">Figure 14</a> and <a href="#">Table 5</a> .

**IMPORTANT NOTICE – PLEASE READ CAREFULLY**

STMicroelectronics NV and its subsidiaries (“ST”) reserve the right to make changes, corrections, enhancements, modifications, and improvements to ST products and/or to this document at any time without notice. Purchasers should obtain the latest relevant information on ST products before placing orders. ST products are sold pursuant to ST’s terms and conditions of sale in place at the time of order acknowledgement.

Purchasers are solely responsible for the choice, selection, and use of ST products and ST assumes no liability for application assistance or the design of Purchasers’ products.

No license, express or implied, to any intellectual property right is granted by ST herein.

Resale of ST products with provisions different from the information set forth herein shall void any warranty granted by ST for such product.

ST and the ST logo are trademarks of ST. For additional information about ST trademarks, please refer to [www.st.com/trademarks](http://www.st.com/trademarks). All other product or service names are the property of their respective owners.

Information in this document supersedes and replaces information previously supplied in any prior versions of this document.

© 2019 STMicroelectronics – All rights reserved

# Mouser Electronics

Authorized Distributor

Click to View Pricing, Inventory, Delivery & Lifecycle Information:

[STMicroelectronics:](#)

[T1235T-8T](#)