

ANT-LTE-CER

Data Sheet

Product Description

The CER Series LTE ceramic chip antenna is a compact, high efficiency antenna designed to be easily integrated into wireless telecommunication devices. Operating in all common 4G/3G/2G LTE bands, it has better efficiency and gain at lower cellular bands compared to competitive products, providing enhanced performance for NB-IoT (Narrow Band Internet of Things) applications. The CER Series antenna's small size saves valuable board space and the integrated solution saves time and money for labor, cable, and connector costs during installation or deployment.

Features

- Covers all common 4G/3G/2G LTE bands
- High efficiency and gain at the lower bands for CAT-M1 and NB-IoT applications
- Small, surface mount package is ideal for integration in small devices

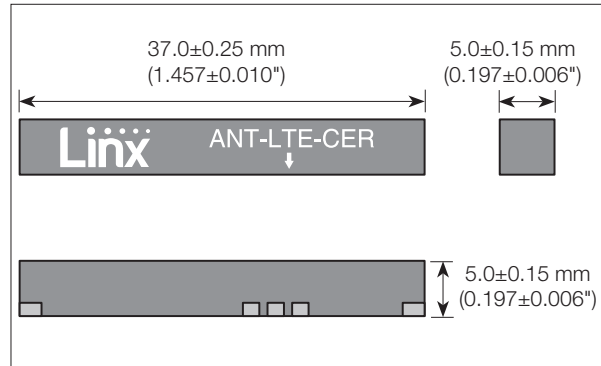

Ordering Information

ANT-LTE-CER-B (supplied in cut tape)
ANT-LTE-CER-T (Tape and reel of 450 pieces)
AEK-LTE-CER (Evaluation Kit)

Electrical Specifications

Electrical Specifications				
Parameter	LTE/ GSM850/ GSM900	DCS/ PCS/ UMTS1	LTE 2300	LTE 2600
Recommended Frequency Range	698 – 960	1710 – 2170	2300 – 2400	2500 – 2700
VSWR	<4:1	<3.2:1	<2.5:1	<2.5:1
Peak Gain	3.5dBi	4.0dBi	3.75dBi	3.0dBi
Average Gain	-2.77dBi	-1.72dBi	-1.23dBi	-2.04dBi
Efficiency	55%	75%	75%	65%
Polarization	Linear			
Radiation	Omni-Directional			
Wavelength	¼-wave			
Impedance	50-ohms			
Connection	Surface-mount			
Weight	3g (0.1oz)			
Operating Temperature Range	-40°C to +85°C			
Storage Temperature Range	-40°C to +85°C			
Relative Humidity	+40°C, 0-95% r.h.			
Polarization	Linear			

Electrical specifications and plots measured with a 45mm x 120mm (1.77" x 4.72") reference ground plane.

VSWR Graph

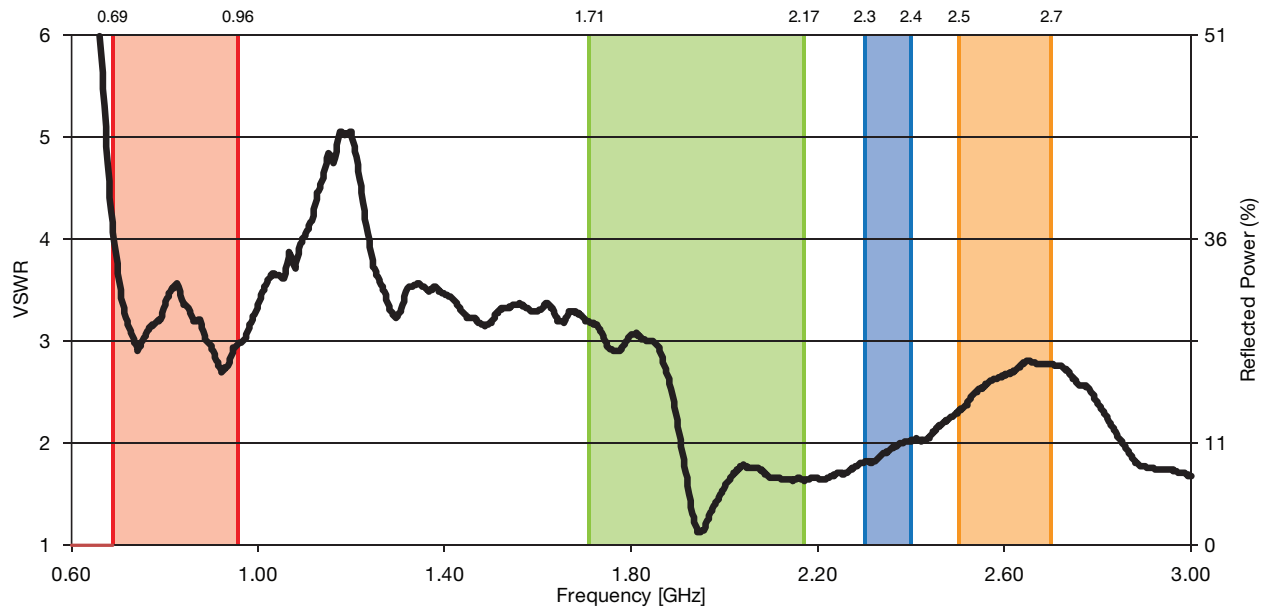

Return Loss

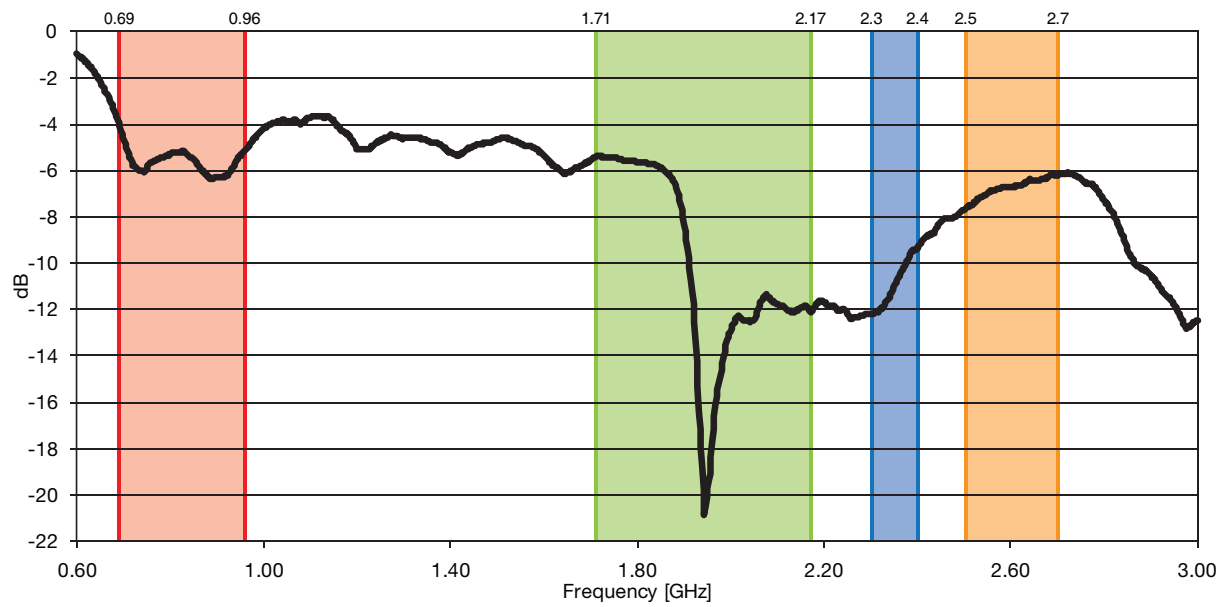

Gain Plots

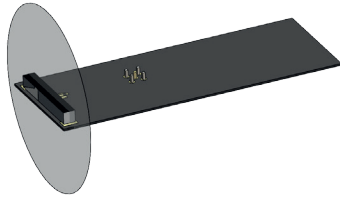

XZ-Plane Gain

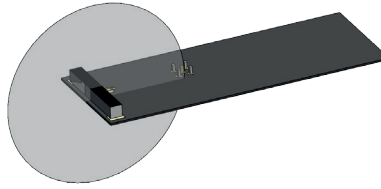

YZ-Plane Gain

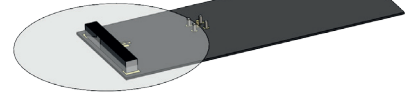

XY-Plane Gain

700 - 960MHz

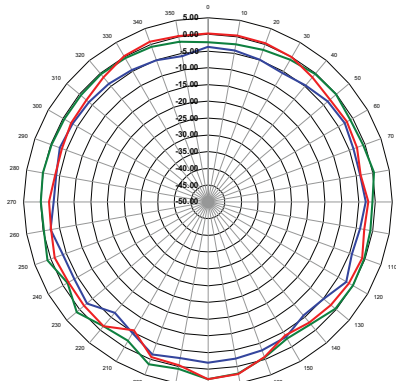

XZ-Plane Gain

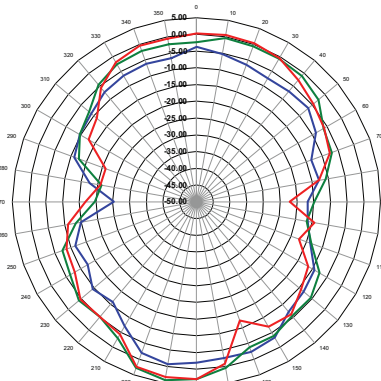

YZ-Plane Gain

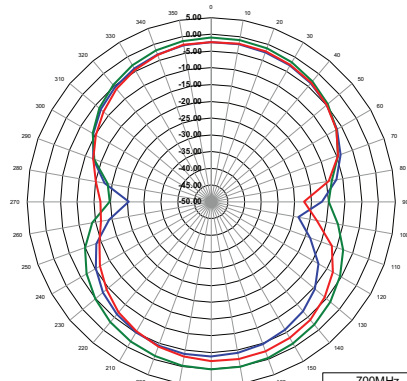

XY-Plane Gain



1710 - 2170MHz

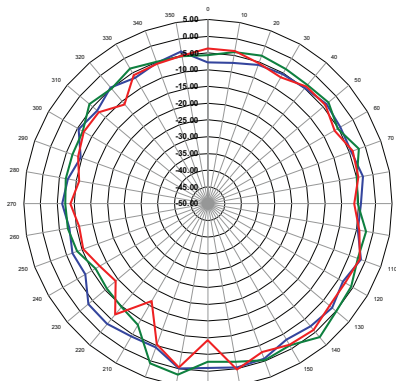

XZ-Plane Gain

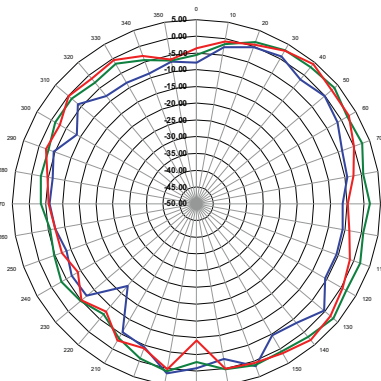

YZ-Plane Gain

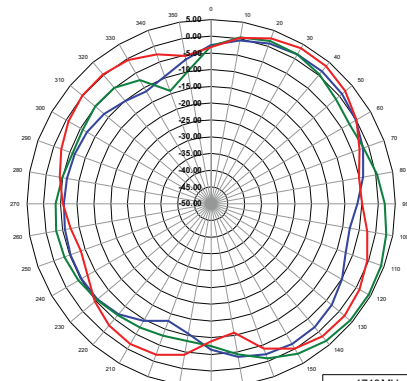

XY-Plane Gain



Gain Plots

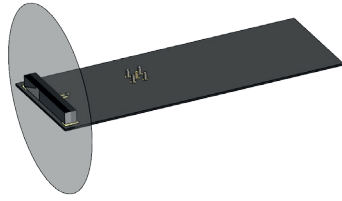

XZ-Plane Gain

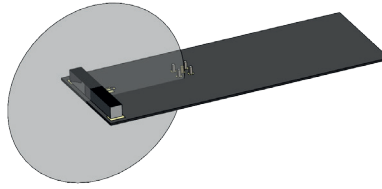

YZ-Plane Gain

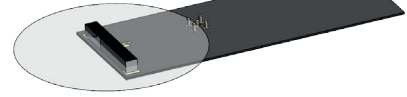

XY-Plane Gain

2300 - 2400MHz

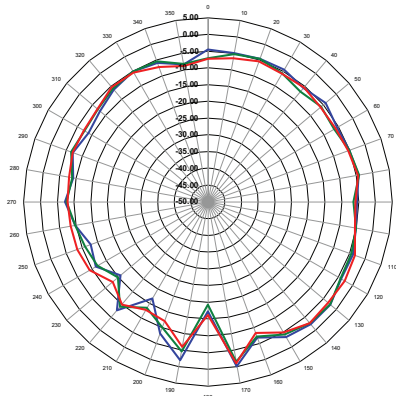

XZ-Plane Gain

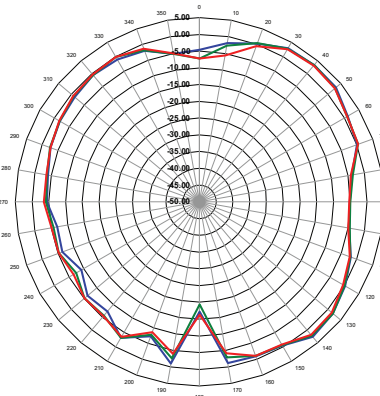

YZ-Plane Gain

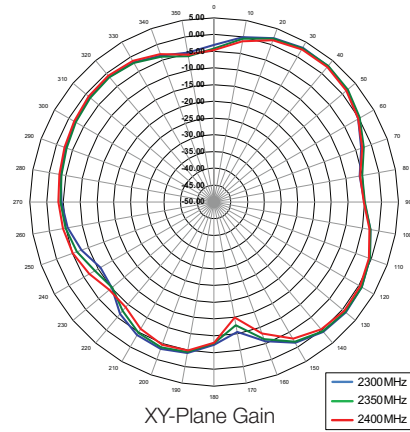

XY-Plane Gain

2500 - 2700MHz

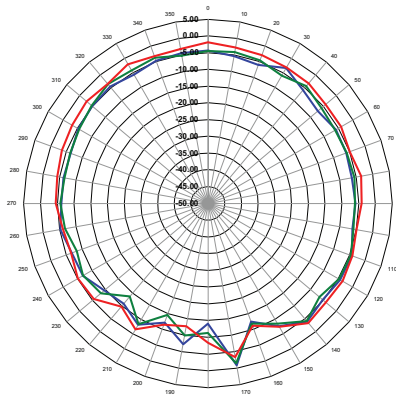

XZ-Plane Gain

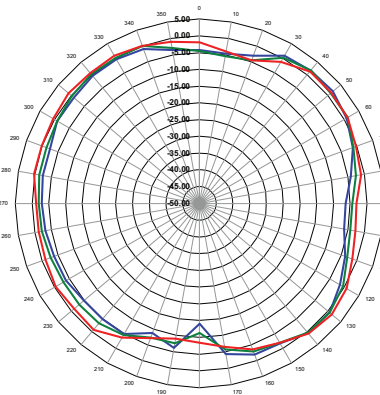

YZ-Plane Gain

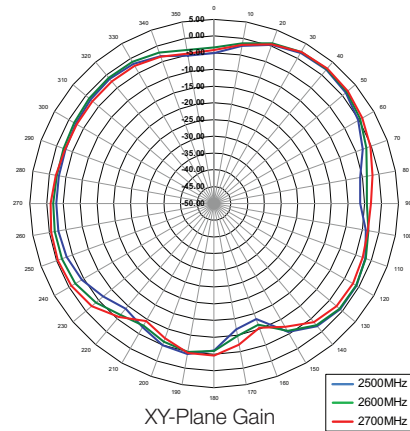

XY-Plane Gain

Peak Gain

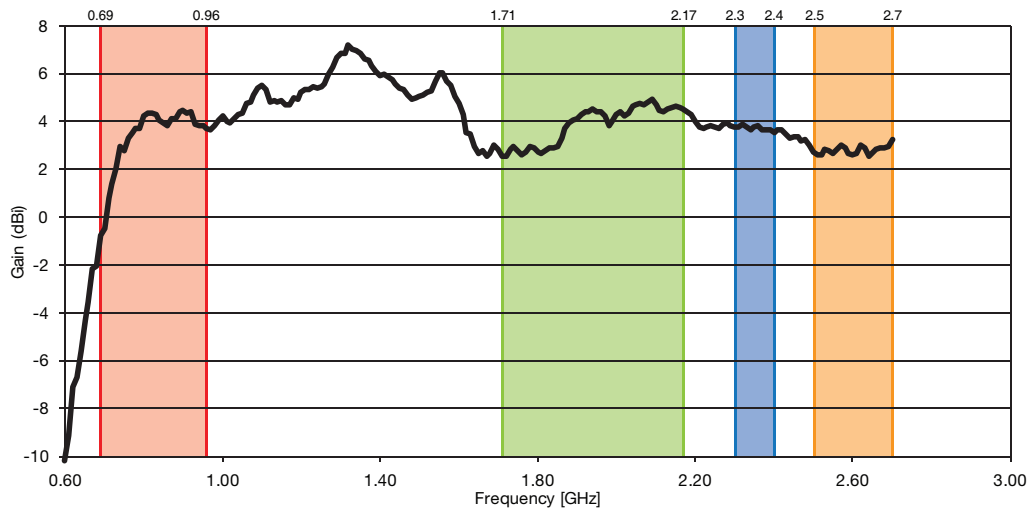

Average Gain

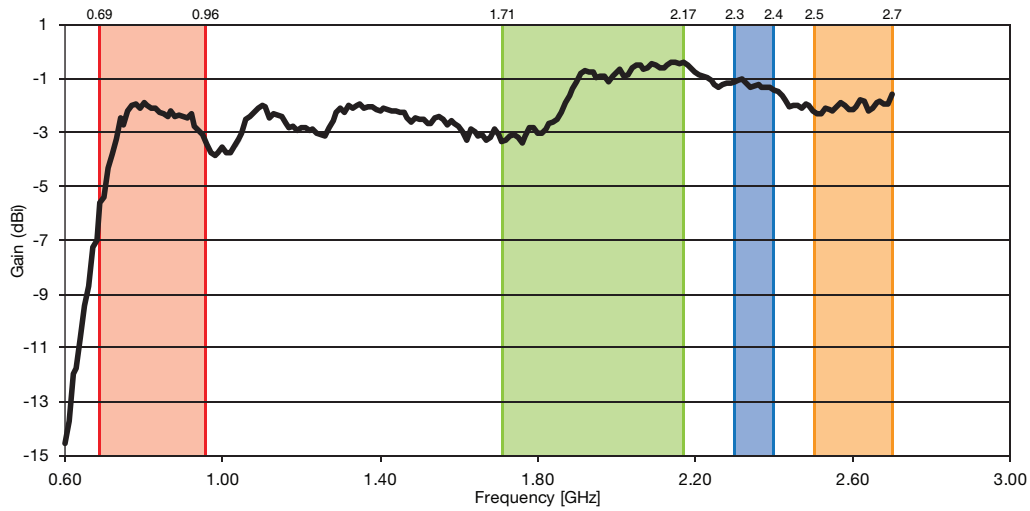

Radiation Efficiency

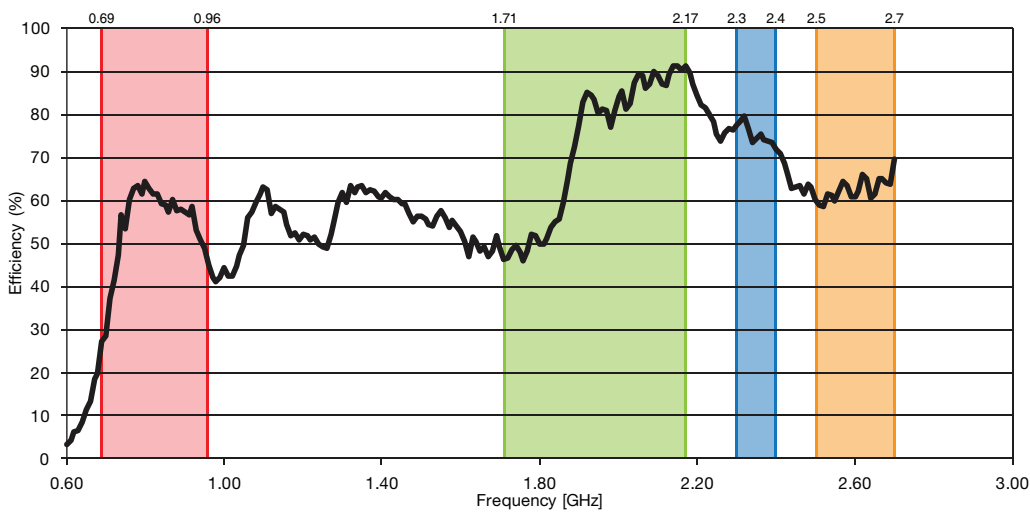

Matching Network

The antenna requires a matching network for optimum performance. This network allows the antenna's response to be optimized for each board, taking into account the PCB layout, other components in the device and the enclosure.

The evaluation board requires two components for a proper match; a series capacitor and a shunt inductor.

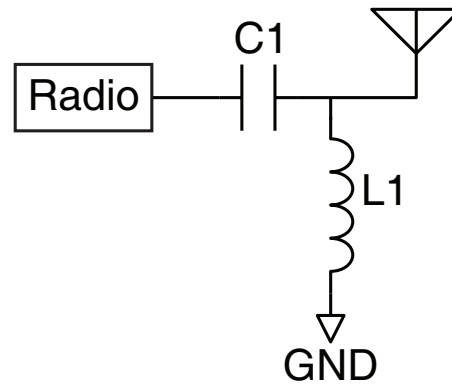

Matching Network		
Designator	Size	Description
L1	0402	6.8nH Inductor (Taiyo Yuden HK10056N8S-T)
C1	0402	3pF Capacitor (Murata Electronics GRM1555C1H3R0CA01D)

These values give the antenna the performance specified in this data sheet on the specified test board. The final product design may change the performance due to the components on the board, different PCB material and layout, and the enclosure around the antenna. It may be necessary to adjust these values to match the specific board.

The performance is critically dependent on many variables, so it is generally not possible to estimate the performance before fabricating the board. Testing on the final board is needed to determine the final values. Linx can help with this tuning if needed. Please contact us for more information.

PCB designs that have a significantly smaller ground plane or large conductive objects near the antenna may need additional tuning. In these cases it is recommended to add pads for a full matching network, as shown below. It is likely that not all of the elements will be needed in the final tuning, but having the pads provides the options to place them if necessary. Testing on the final board is needed to determine which elements are required and what their values should be.

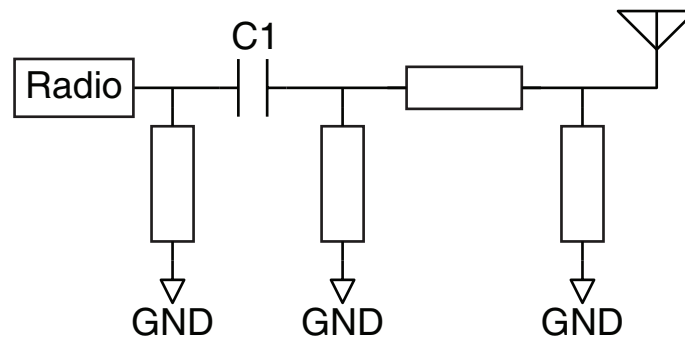

PCB Layout - Typical Matching Network

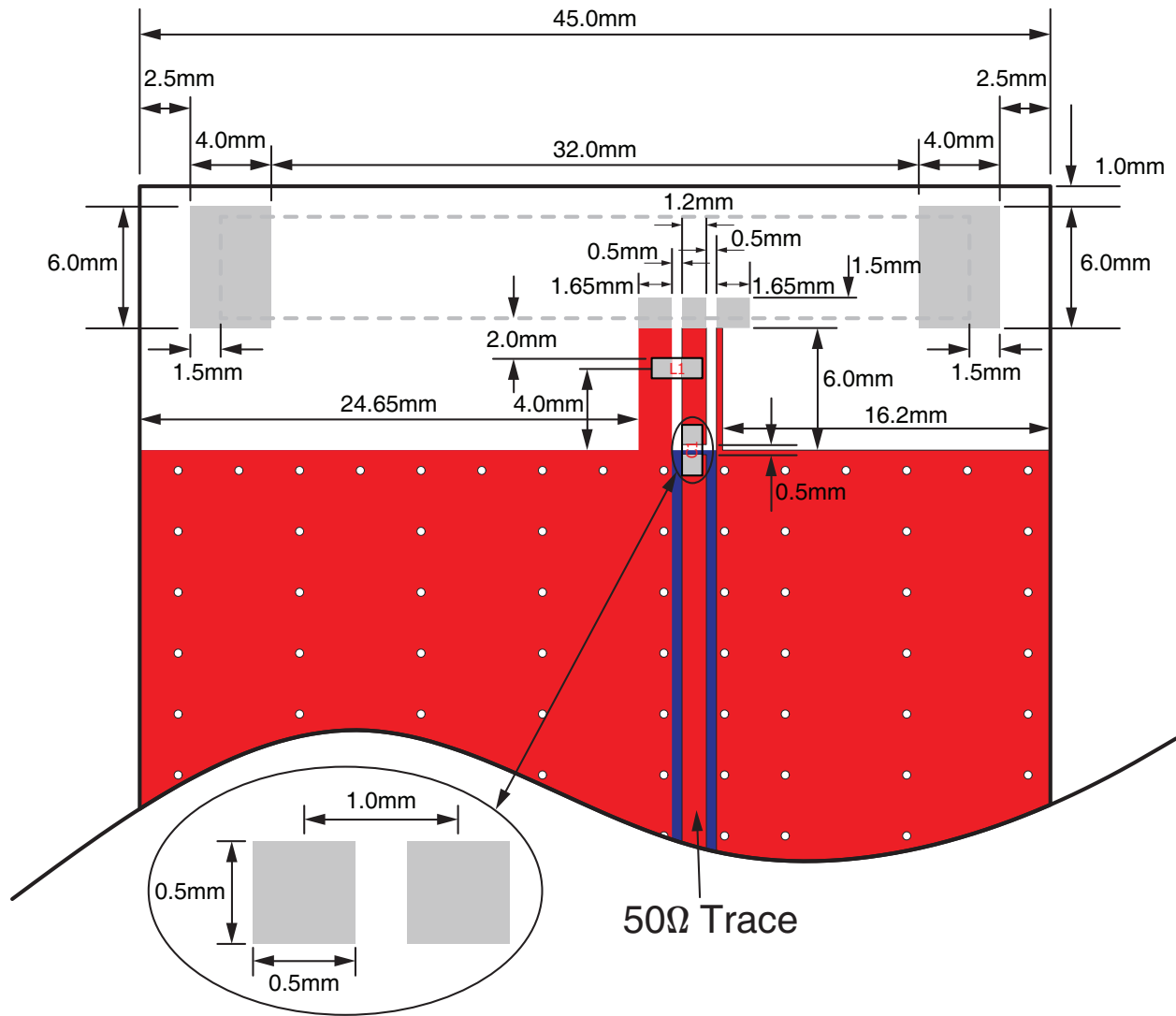

Matching Network

Designator	Size	Description
L1	0402	6.8nH Inductor (Taiyo Yuden HK10056N8S-T)
C1	0402	3pF Capacitor (Murata Electronics GRM1555C1H3R0CA01D)

PCB Layout - Full Matching Network

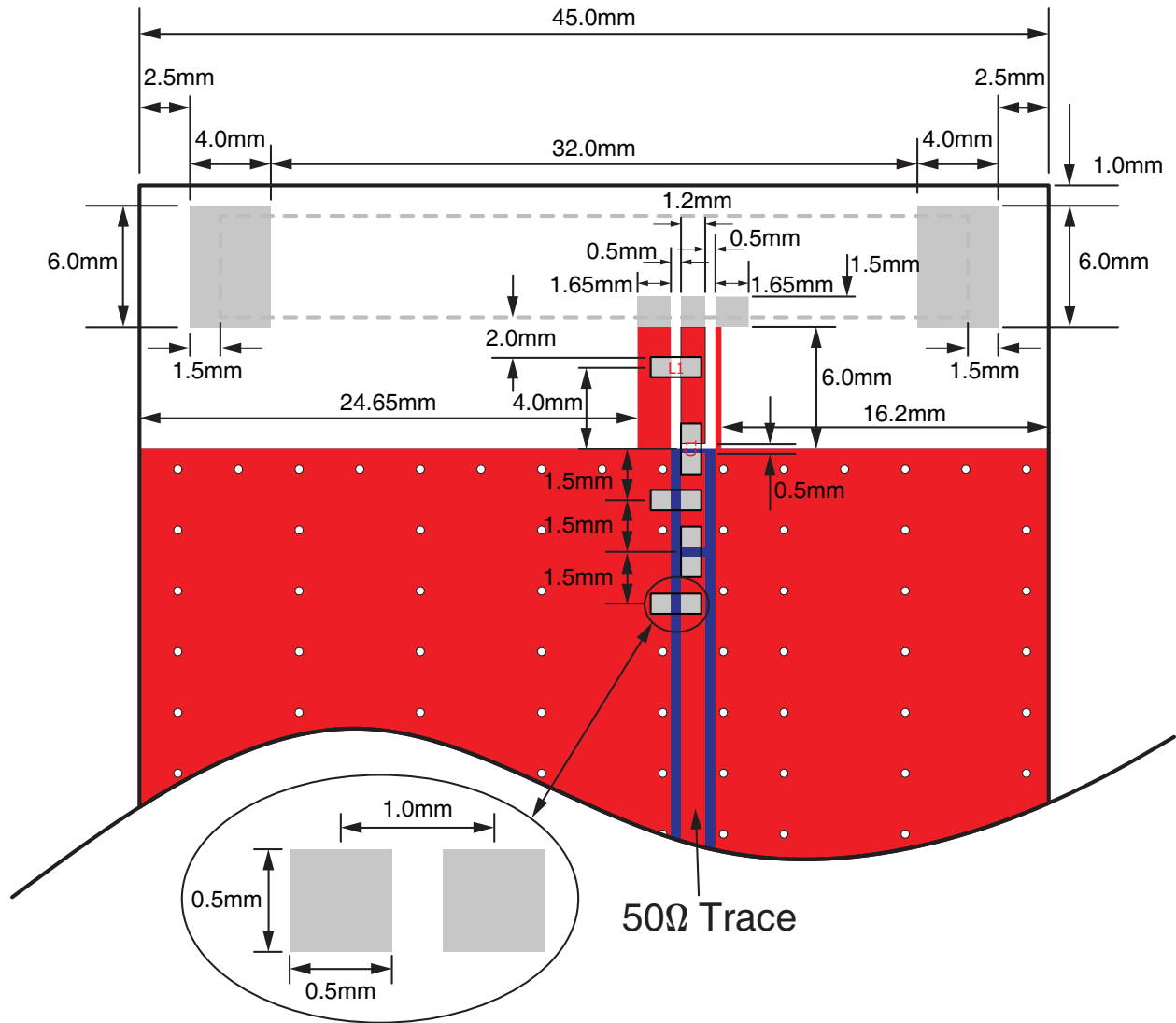

Component values are determined through testing. Contact Linx for more information on matching network assistance.

PCB Layout Guidelines and Considerations

The PCB layout is critical to the antenna's successful implementation. The following guidelines should be followed to get the optimum performance out of the antenna.

- Use a manufactured board for testing the antenna performance. RF is very picky and perf boards or other "hacked" boards will at best give a poor indication of the antenna's true performance and at worst will simply not work. The recommended layout that should be followed as closely as possible to get the specified performance. An evaluation kit that includes a test board is available, so please contact us for details.
- The antenna should, as much as reasonably possible, be isolated from other components on the PCB, especially high-frequency circuitry such as crystal oscillators, switching power supplies, and high-speed bus lines. Everything in the antenna's near field (within one wavelength) has an impact on the radiation pattern and performance, so the antenna needs to be on its own. This is contrary to much of today's designs where everything is compacted as much as possible, but it is what is necessary to get the most out of the antenna.
- Keep traces away from the antenna. Traces can become antennas themselves, frequently at a harmonic of the operational frequency. This can cause issues when going for regulatory certifications. This includes traces under the antenna itself on any layer of the board. Unshielded wires and wire harnesses inside the enclosure also need to be kept away for the same reason. Be sure to secure them so that they will not come loose and fall across the antenna.
- The antenna is only half of the complete antenna structure. The other half is a ground plane counterpoise on the circuit board. The dimensions of the plane are critical to the antenna's performance and it should be as solid as possible. It can act as the ground connection for other circuits on the board. More details on the function of the ground plane can be found in application notes AN-00500 and AN-00501.
- The antennas are tuned to be 50 ohms at the frequency of operation. The connection to the radio needs to be a single-ended 50-ohm transmission line. This is typically either a microstrip line or a co-planar waveguide.
- The product's enclosure needs to be non-conductive. Embedded antennas cannot be used effectively in metal, carbon fiber or some fiberglass enclosures. Placing non-conductive panels in metal enclosures does allow some signal to get out in the direction of the panel, but has a significant impact on the overall performance. Not only does it potentially reduce the radiated power, it also focuses the power just like a flashlight focuses the light from a bulb. This gives great range during initial testing, but can be a great disappointment when regulatory compliance testing requires the transmitter power to be reduced. This could result in much less range than was achieved during initial testing and greatly affects the product's performance.
- There should be no traces, planes or any copper under the antenna or to its sides on any layer of the board. Anything conductive in this area will impact the radiation pattern and the antenna's performance.
- A matching circuit is recommended to allow the antenna's performance to be tuned to the final product.
- The antenna should be placed on the PCB's shortest edge, allowing the longest dimension to be dedicated to the ground plane counterpoise.

Evaluation Board Layout

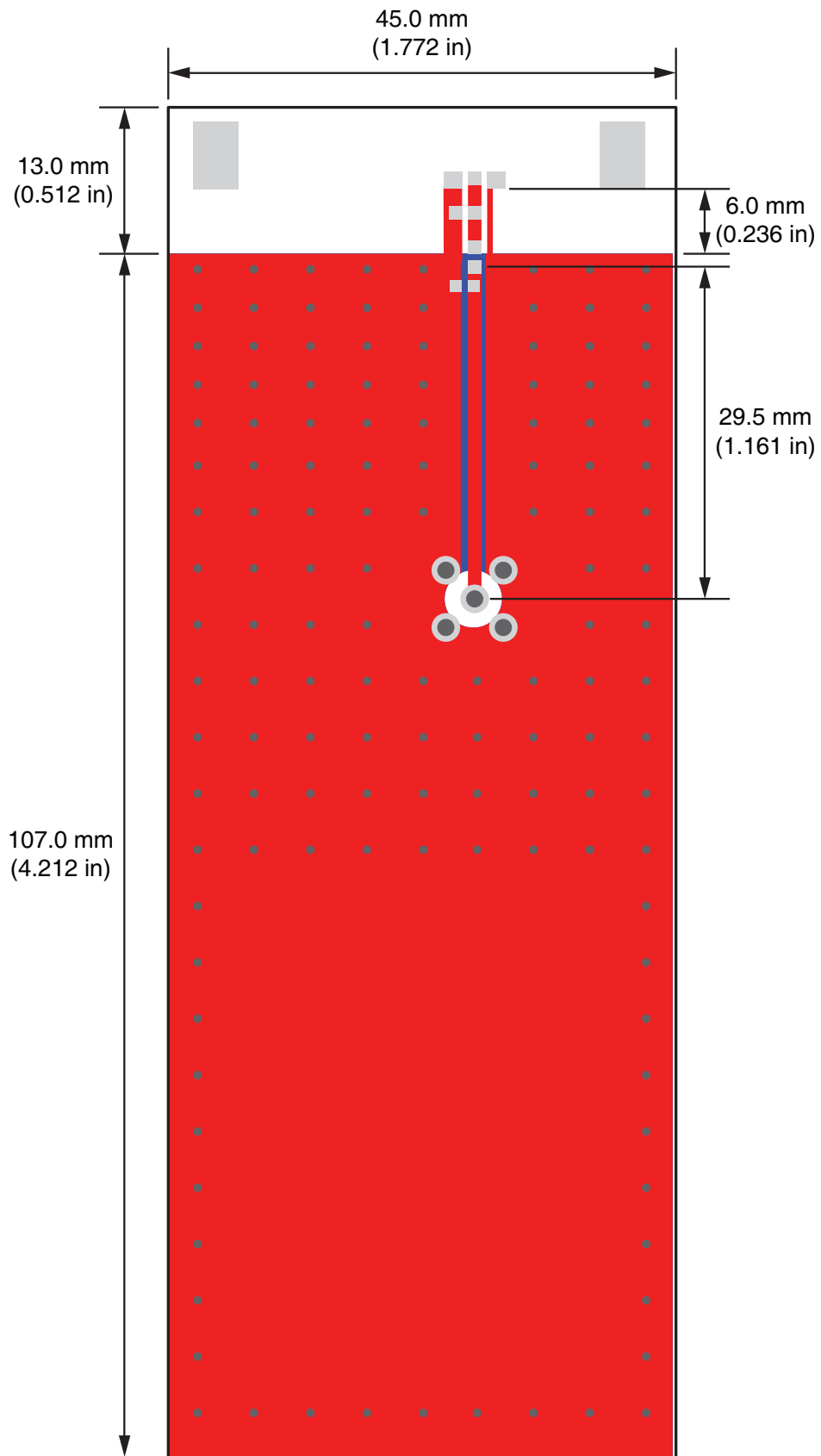

Reflow Solder Profile

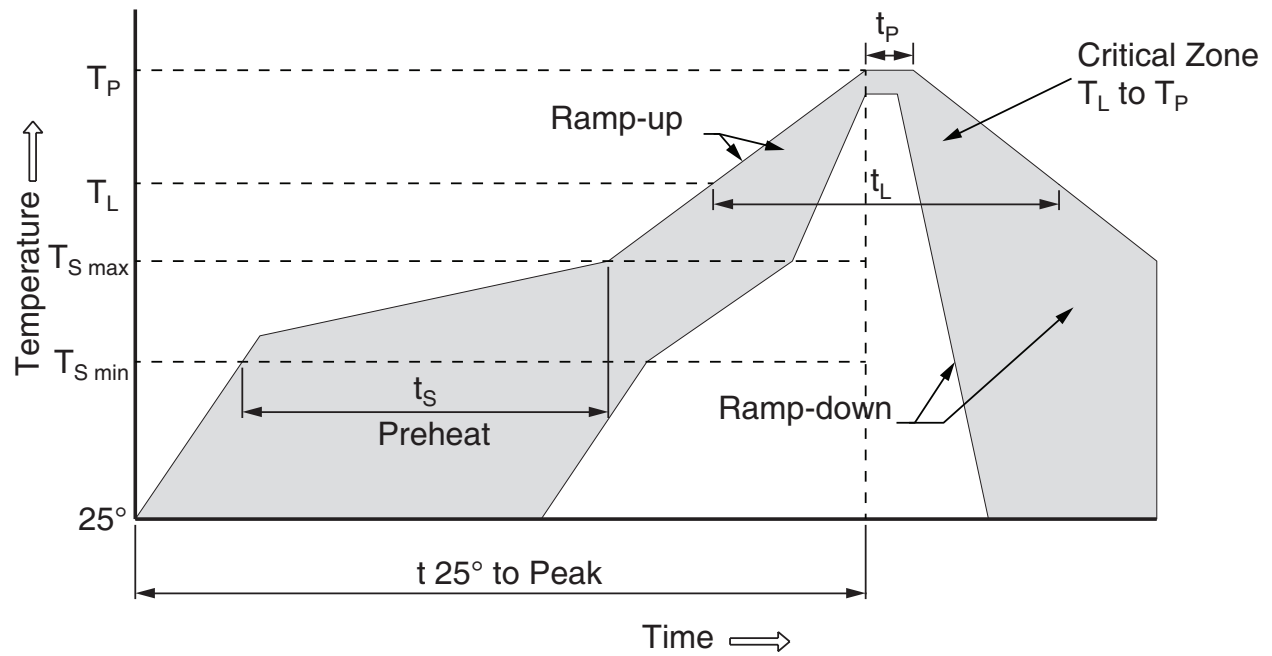

Reflow Solder Profile			
Phase	Profile Features	Leaded Solder Profile	Lead-Free Solder Profile
Ramp-up	Avg. Ramp-up Rate (Tsmax to TP)	3°C per second (max)	3°C per second (max)
Preheat	Temperature Min (TSmin) Temperature Max (Tsmax) Time (tsmin to tsmax)	100°C 150°C 60 to 120 seconds	100°C 150°C 60 to 120 seconds
Reflow	Temperature(TL) Total Time above TL (tL)	183°C 60 to 150 seconds	217°C 60 to 150 seconds
Peak	Temperature(TP) Time(tp)	235°C 10 to 30 seconds	260°C 20 to 40 seconds
Ramp-down	Rate	6°C per second (max)	6°C per second (max)
Time from 25°C to Peak Temperature		6 minutes max	8 minutes max

Tape and Reel Packaging

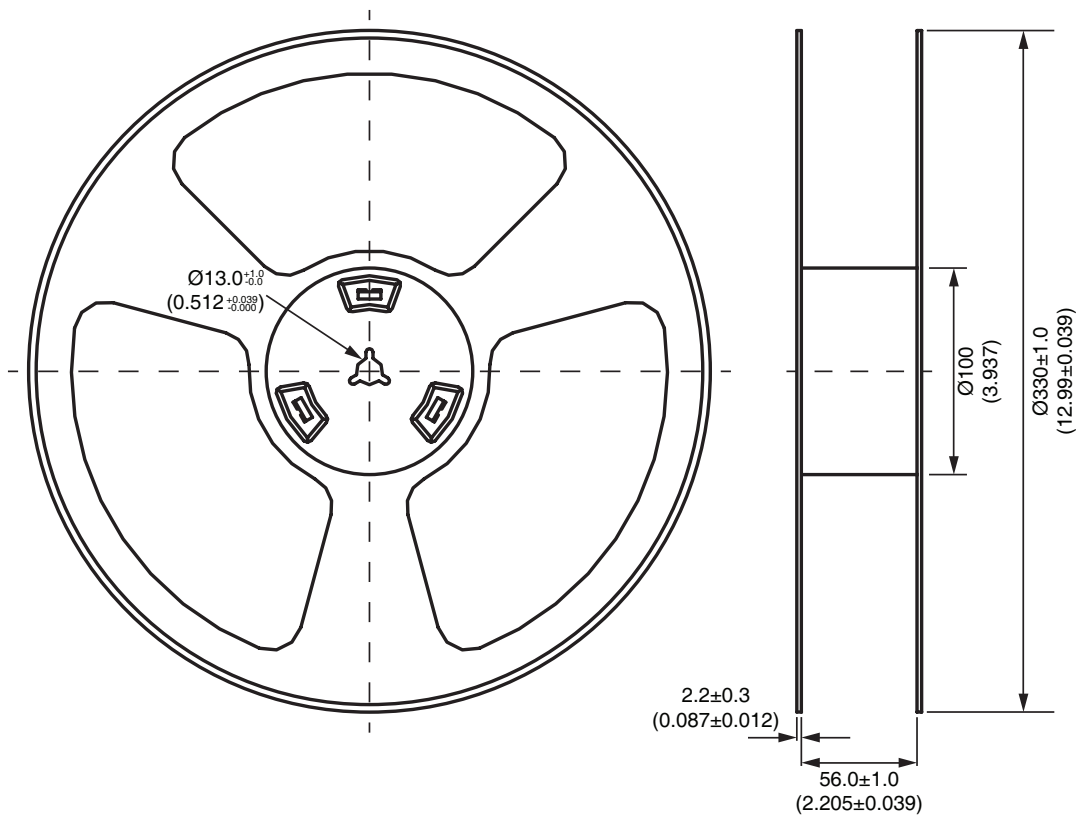
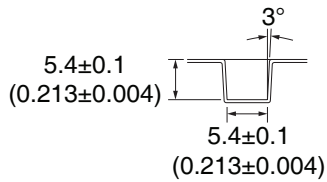
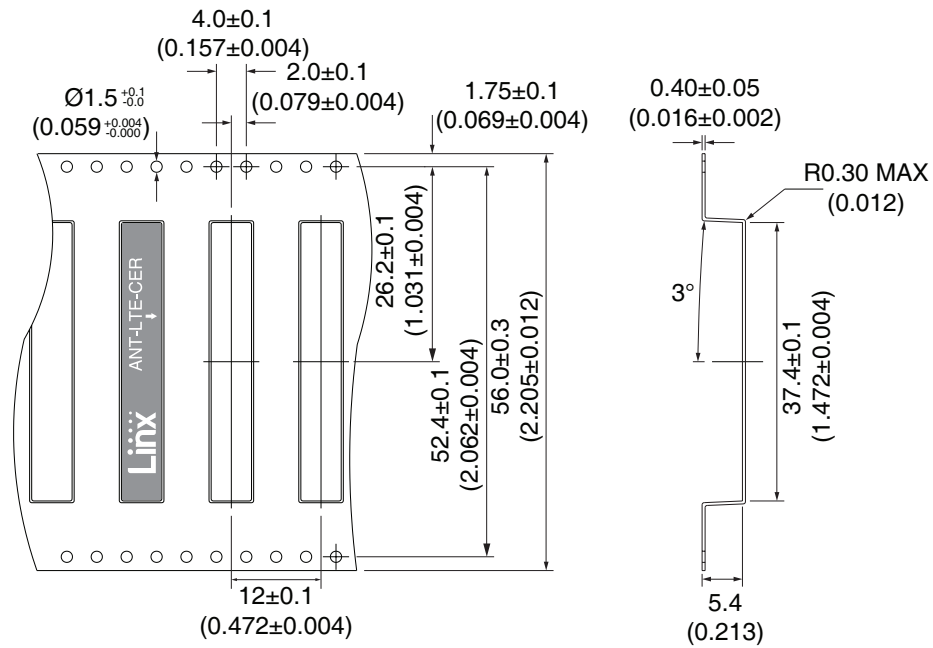

Appendix 1, Transmission Lines for Embedded Antennas

A transmission line is a medium whereby RF energy is transferred from one place to another with minimal loss. It is designed for a specific characteristic impedance to match the antenna to the radio. This is a critical factor, especially in high-frequency products because the trace leading to the antenna can effectively contribute to the length of the antenna, changing its resonant frequency. This detuning increases energy loss in the system and reduces overall range of the radio link. In order to minimize loss and detuning, some form of transmission line between the antenna and the radio should be used. There are several kinds of transmission lines but two are commonly used for low-cost embedded radios; a microstrip line and a co-planar waveguide.

Microstrip Transmission Lines

A microstrip is a PCB trace that runs over a ground plane. There are several factors that contribute to its characteristic impedance, but the two most critical ones are distance from the ground plane and width of the trace. The calculations and some examples are shown below.

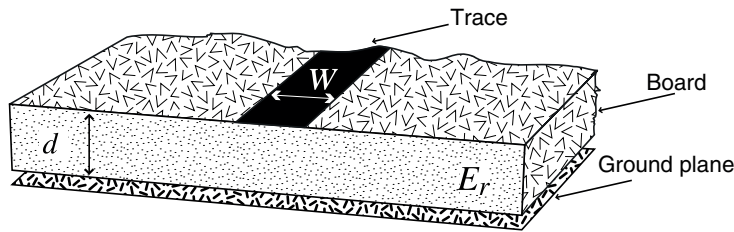

$$E_e = \frac{E_r + 1}{2} + \frac{E_r - 1}{2} \cdot \frac{1}{\sqrt{1 + 12d/W}}$$

$$Z_0 = \begin{cases} \frac{60}{\sqrt{E_e}} \cdot \ln\left(\frac{8d}{W} + \frac{W}{4d}\right) & \text{For } \frac{W}{d} \leq 1 \\ \frac{120\pi}{\sqrt{E_e} \cdot \left(\frac{W}{d} + 1.393 + 0.667 \cdot \ln\left(\frac{W}{d} + 1.444\right)\right)} & \text{For } \frac{W}{d} \geq 1 \end{cases}$$

E_r = Dielectric constant of PCB material

Example Microstrip Calculations

Dielectric Constant	Width / Height Ratio (W / d)	Effective Dielectric Constant	Characteristic Impedance (Ω)
4.80	1.8	3.59	50.0
4.00	2.0	3.07	51.0
2.55	3.0	2.12	48.8

Grounded Coplanar Waveguide

A grounded coplanar waveguide is a PCB trace that has ground plane on both sides and on a lower layer. This structure allows more precise control over the line impedance and results in smaller trace widths at a

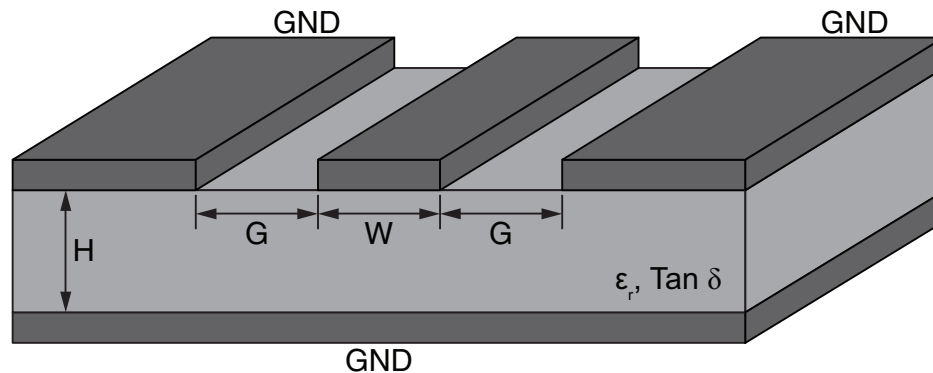

given impedance. The calculations for the design get fairly complicated, so online calculators are generally used or calculators built into design software.

Because the ground plane is on both sides of the trace and on the bottom, it is important to ensure that the planes are at the same impedance. Vias are typically added in rows along the edge of the gaps to connect the top plane to the bottom plane. This is referred to as “fencing” or “stapling”. When adding vias, the rule-of-thumb is to add them at spacings of $1/8$ of a wavelength or less. This gives good isolation and makes the ground plane look solid.

For the best isolation, the rule is to space vias at $1/20$ of a wavelength or less. However, this is generally overkill for most commercial products and the $1/8$ rule is more practical.

TE TECHNICAL SUPPORT CENTER

USA:	+1 (800) 522-6752
Canada:	+1 (905) 475-6222
Mexico:	+52 (0) 55-1106-0800
Latin/S. America:	+54 (0) 11-4733-2200
Germany:	+49 (0) 6251-133-1999
UK:	+44 (0) 800-267666
France:	+33 (0) 1-3420-8686
Netherlands:	+31 (0) 73-6246-999
China:	+86 (0) 400-820-6015

te.com

TE Connectivity, TE, TE connectivity (logo), Linx and Linx Technologies are trademarks owned or licensed by the TE Connectivity Ltd. family of companies. All other logos, products and/or company names referred to herein might be trademarks of their respective owners.

The information given herein, including drawings, illustrations and schematics which are intended for illustration purposes only, is believed to be reliable. However, TE Connectivity makes no warranties as to its accuracy or completeness and disclaims any liability in connection with its use. TE Connectivity's obligations shall only be as set forth in TE Connectivity's Standard Terms and Conditions of Sale for this product and in no case will TE Connectivity be liable for any incidental, indirect or consequential damages arising out of the sale, resale, use or misuse of the product. Users of TE Connectivity products should make their own evaluation to determine the suitability of each such product for the specific application.

TE Connectivity warrants to the original end user customer of its products that its products are free from defects in material and workmanship. Subject to conditions and limitations TE Connectivity will, at its option, either repair or replace any part of its products that prove defective because of improper workmanship or materials. This limited warranty is in force for the useful lifetime of the original end product into which the TE Connectivity product is installed. Useful lifetime of the original end product may vary but is not warranted to exceed one (1) year from the original date of the end product purchase.

©2023 TE Connectivity. All Rights Reserved.

04/23 Original

Mouser Electronics

Authorized Distributor

Click to View Pricing, Inventory, Delivery & Lifecycle Information:

[TE Connectivity:](#)

[ANT-LTE-CER-T](#)