



1

2

3

4

5

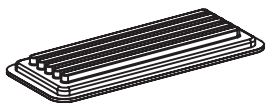
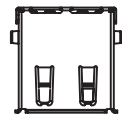

TRAY

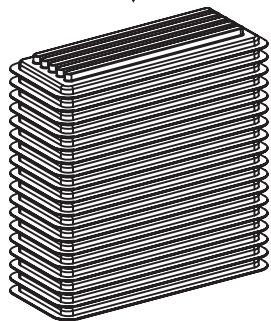

22 TRAYS

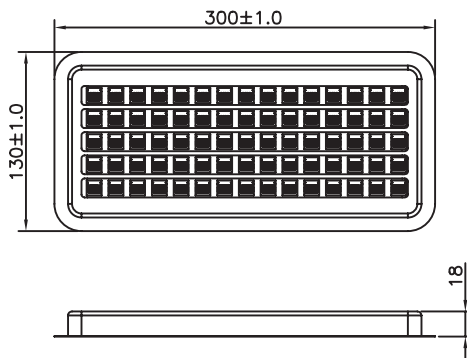

Two Row

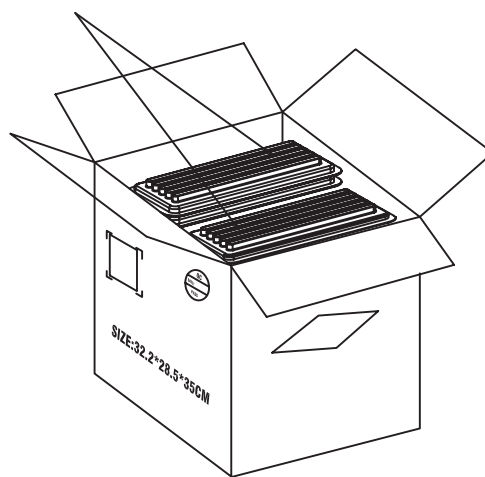

Note:

1.Dimension:  
Tray Size: 300(L)X130(W)X18.0(H) (mm)  
Carton Size: 322X285X350 (mm)

2.Quqntity:  
60pcs/Tray  
44Tray/ Carton  
Q'TY: 2640pcs

3.G.W: 7.12KG/Carton

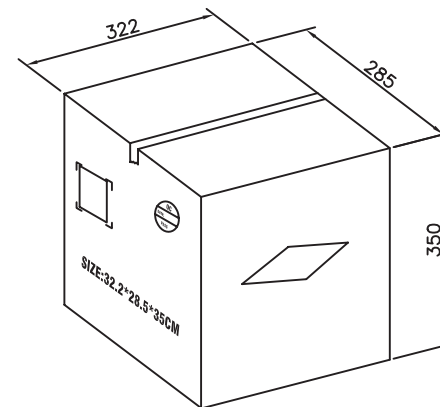

CARTON

RoHS Compliant

PROJECTION:

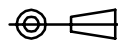

GENERAL TOLERANCE

.X = +/- 0.2

.XX = +/- 0.15



APPROVAL: NP

UNIT: MM

SCALE:

SHEET: 2/2

DRAW: QL

DESCRIPTION: USB 2.0 FEMALE R/A A TYPE

WERI PART NO: 614 004 160 21

SIZE

A4

G				APPROVAL: NP UNIT: MM SCALE: SHEET: 2/2 DRAW: QL	DESCRIPTION: USB 2.0 FEMALE R/A A TYPE WERI PART NO: 614 004 160 21	SIZE <b>A4</b>
F						
E						
D						
C						
B						
A						
REV	DATE	FILE	BY			