

## High Speed Infrared Emitting Diode, 940 nm, Surface Emitter Technology

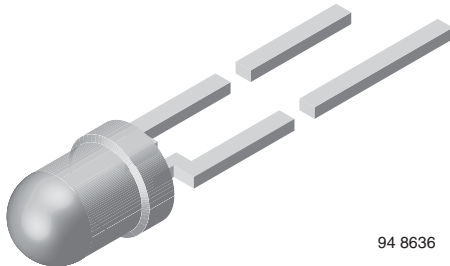

94 8636

### DESCRIPTION

As part of the SurfLight™ portfolio, the VSLY3943 is a high speed infrared emitting diode based on surface emitter technology, molded in a blue-gray plastic package.

### FEATURES

- Package type: leaded
- Package form: T-1, clear epoxy
- Dimensions: Ø 3 mm
- Peak wavelength:  $\lambda_p = 940$  nm
- High speed
- High radiant power
- High radiant intensity
- Angle of half intensity:  $\phi = \pm 17^\circ$
- Low forward voltage
- Good spectral matching to Si photodetectors
- Material categorization: for definitions of compliance please see [www.vishay.com/doc?99912](http://www.vishay.com/doc?99912)



### APPLICATIONS

- Infrared remote control units
- Free air transmission systems
- Infrared source for optical counters and card readers

### PRODUCT SUMMARY

COMPONENT	$I_e$ (mW/sr)	$\phi$ (deg)	$\lambda_p$ (nm)	$t_r$ (ns)
VSLY3943	70	$\pm 17$	940	5

#### Note

- Test conditions see table “Basic Characteristics”

### ORDERING INFORMATION

ORDERING CODE	PACKAGING	REMARKS	PACKAGE FORM
VSLY3943	Bulk	MOQ: 5000 pcs, 5000 pcs/bulk	T-1
VSLY3943-MSZ	Ammopack	MOQ: 10 000 pcs, 2000 pcs/box	T-1

#### Note

- MOQ: minimum order quantity

### ABSOLUTE MAXIMUM RATINGS ( $T_{amb} = 25$ °C, unless otherwise specified)

PARAMETER	TEST CONDITION	SYMBOL	VALUE	UNIT
Reverse voltage		$V_R$	5	V
Forward current		$I_F$	70	mA
Peak forward current	$t_p/T = 0.1, t_p = 100$ $\mu$ s	$I_{FM}$	140	mA
Surge forward current	$t_p = 100$ $\mu$ s	$I_{FSM}$	500	mA
Power dissipation		$P_V$	160	mW
Junction temperature		$T_j$	100	°C
Operating temperature range		$T_{amb}$	-40 to +85	°C
Storage temperature range		$T_{stg}$	-40 to +100	°C
Soldering temperature	$t \leq 5$ s, 2 mm from case	$T_{sd}$	260	°C
Thermal resistance junction-to-ambient	J-STD-051, leads 7 mm, soldered on PCB	$R_{thJA}$	300	K/W

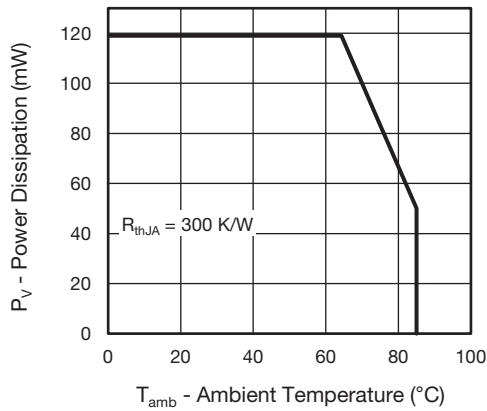

Fig. 1 - Power Dissipation Limit vs. Ambient Temperature

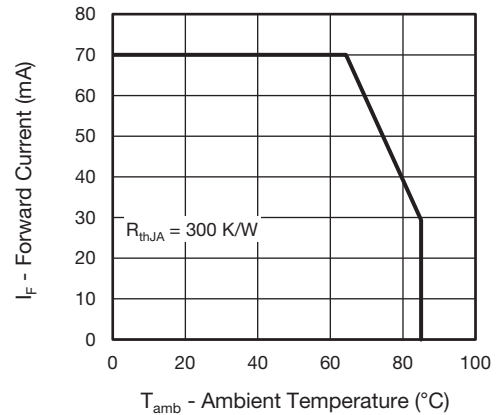

Fig. 2 - Forward Current Limit vs. Ambient Temperature

<b>BASIC CHARACTERISTICS</b> ( $T_{amb} = 25\text{ }^{\circ}\text{C}$ , unless otherwise specified)						
PARAMETER	TEST CONDITION	SYMBOL	MIN.	TYP.	MAX.	UNIT
Forward voltage	$I_F = 70\text{ mA}$ , $t_p = 20\text{ ms}$	$V_F$	-	1.5	1.7	V
	$I_F = 500\text{ mA}$ , $t_p = 100\text{ }\mu\text{s}$	$V_F$	-	2.6	-	V
Temperature coefficient of $V_F$	$I_F = 50\text{ mA}$	$TK_{V_F}$	-	-0.7	-	mV/K
Reverse current	$V_R = 5\text{ V}$	$I_R$	Not designed for reverse operation			$\mu\text{A}$
Junction capacitance	$V_R = 0\text{ V}$ , $f = 1\text{ MHz}$ , $E = 0\text{ mW/cm}^2$	$C_J$	-	30	-	pF
Radiant intensity	$I_F = 70\text{ mA}$ , $t_p = 20\text{ ms}$	$I_e$	32	70	120	mW/sr
	$I_F = 500\text{ mA}$ , $t_p = 100\text{ }\mu\text{s}$	$I_e$	-	650	-	mW/sr
Radiant power	$I_F = 70\text{ mA}$ , $t_p = 20\text{ ms}$	$\phi_e$	-	40	-	mW
Temperature coefficient of radiant power	$I_F = 50\text{ mA}$	$TK_{\phi_e}$	-	-0.2	-	%/K
Angle of half intensity		$\phi$	-	$\pm 17$	-	deg
Peak wavelength	$I_F = 50\text{ mA}$	$\lambda_p$	-	940	-	nm
Spectral bandwidth	$I_F = 70\text{ mA}$	$\Delta\lambda$	-	55	-	nm
Temperature coefficient of $I_p$	$I_F = 70\text{ mA}$	$TK_{\lambda_p}$	-	0.28	-	nm
Rise time	$I_F = 70\text{ mA}$ , 10 % to 90 %	$t_r$	-	5	-	ns
Fall time	$I_F = 70\text{ mA}$ , 10 % to 90 %	$t_f$	-	6	-	ns

**BASIC CHARACTERISTICS** ( $T_{amb} = 25\text{ }^{\circ}\text{C}$ , unless otherwise specified)

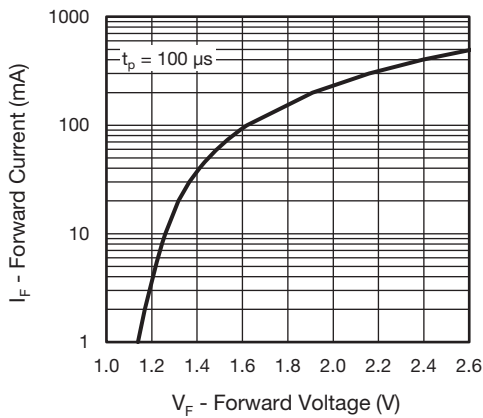

Fig. 3 - Forward Current vs. Forward Voltage

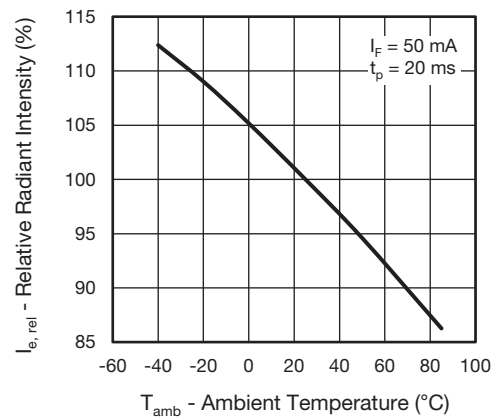

Fig. 6 - Relative Radiant Intensity vs. Ambient Temperature

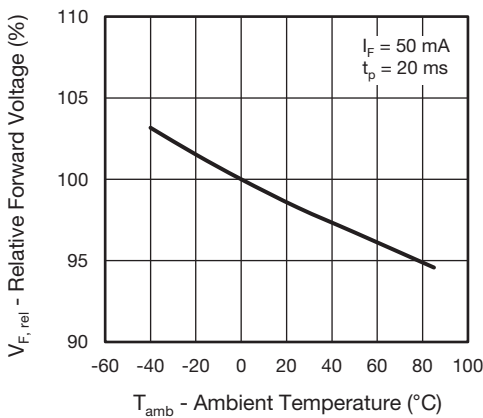

Fig. 4 - Relative Forward Voltage vs. Ambient Temperature

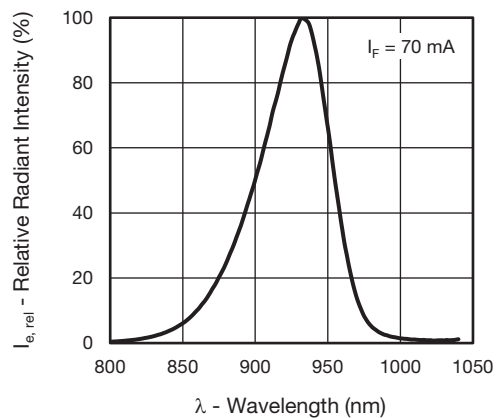

Fig. 7 - Relative Radiant Intensity vs. Wavelength

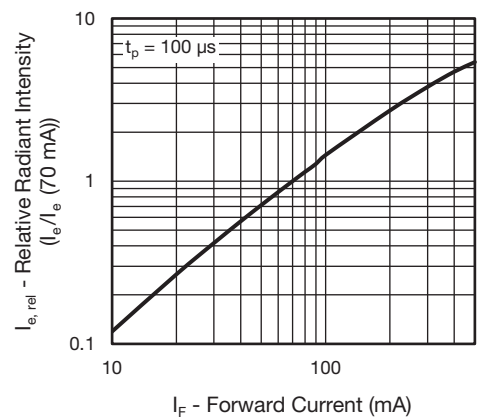

Fig. 5 - Relative Radiant Intensity vs. Forward Current

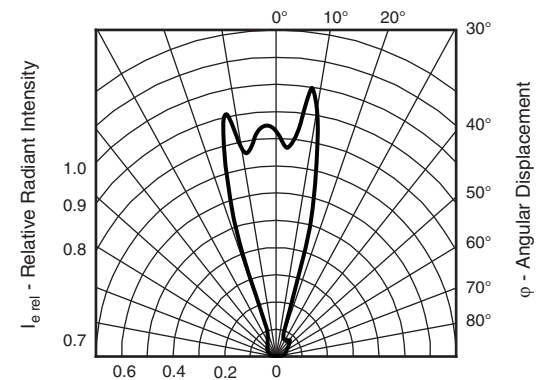
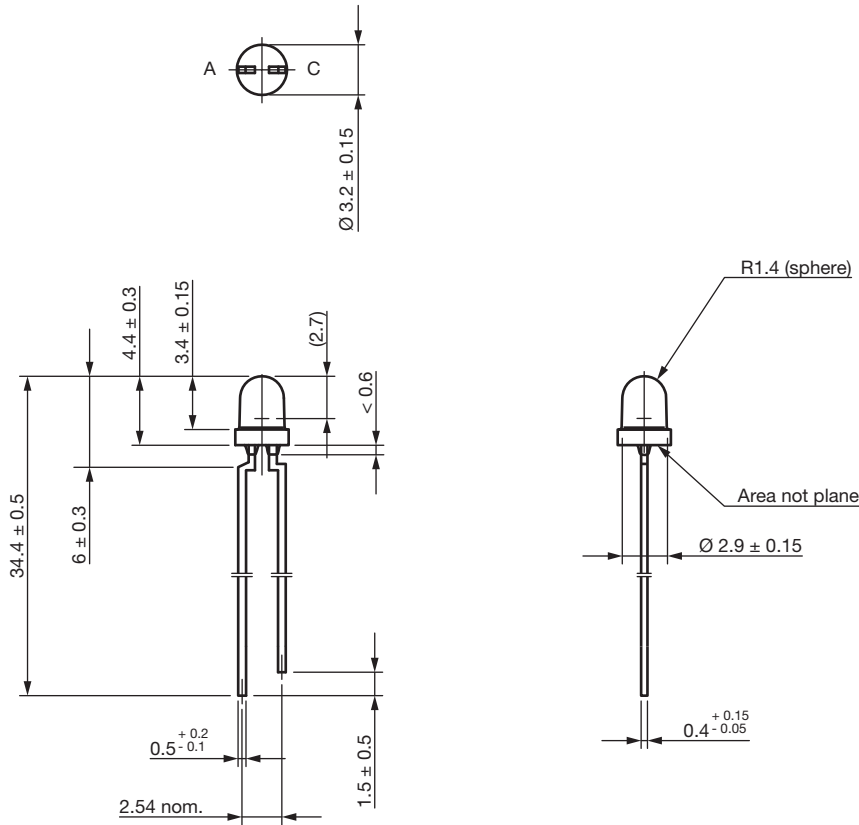

Fig. 8 - Relative Radiant Intensity vs. Angular Displacement

**PACKAGE DIMENSIONS** in millimeters



technical drawings  
according to DIN  
specifications

Drawing-No.: 6.541-5118.01-4  
Issue: 1; 13.12.17



## Disclaimer

ALL PRODUCT, PRODUCT SPECIFICATIONS AND DATA ARE SUBJECT TO CHANGE WITHOUT NOTICE TO IMPROVE RELIABILITY, FUNCTION OR DESIGN OR OTHERWISE.

Vishay Intertechnology, Inc., its affiliates, agents, and employees, and all persons acting on its or their behalf (collectively, "Vishay"), disclaim any and all liability for any errors, inaccuracies or incompleteness contained in any datasheet or in any other disclosure relating to any product.

Vishay makes no warranty, representation or guarantee regarding the suitability of the products for any particular purpose or the continuing production of any product. To the maximum extent permitted by applicable law, Vishay disclaims (i) any and all liability arising out of the application or use of any product, (ii) any and all liability, including without limitation special, consequential or incidental damages, and (iii) any and all implied warranties, including warranties of fitness for particular purpose, non-infringement and merchantability.

Statements regarding the suitability of products for certain types of applications are based on Vishay's knowledge of typical requirements that are often placed on Vishay products in generic applications. Such statements are not binding statements about the suitability of products for a particular application. It is the customer's responsibility to validate that a particular product with the properties described in the product specification is suitable for use in a particular application. Parameters provided in datasheets and / or specifications may vary in different applications and performance may vary over time. All operating parameters, including typical parameters, must be validated for each customer application by the customer's technical experts. Product specifications do not expand or otherwise modify Vishay's terms and conditions of purchase, including but not limited to the warranty expressed therein.

Hyperlinks included in this datasheet may direct users to third-party websites. These links are provided as a convenience and for informational purposes only. Inclusion of these hyperlinks does not constitute an endorsement or an approval by Vishay of any of the products, services or opinions of the corporation, organization or individual associated with the third-party website. Vishay disclaims any and all liability and bears no responsibility for the accuracy, legality or content of the third-party website or for that of subsequent links.

Except as expressly indicated in writing, Vishay products are not designed for use in medical, life-saving, or life-sustaining applications or for any other application in which the failure of the Vishay product could result in personal injury or death. Customers using or selling Vishay products not expressly indicated for use in such applications do so at their own risk. Please contact authorized Vishay personnel to obtain written terms and conditions regarding products designed for such applications.

No license, express or implied, by estoppel or otherwise, to any intellectual property rights is granted by this document or by any conduct of Vishay. Product names and markings noted herein may be trademarks of their respective owners.