

FIBRE WASHER

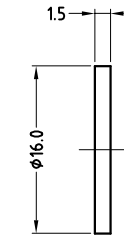

**NUT OPTIONS**

PLASTIC NUT

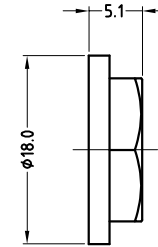

METAL NUT

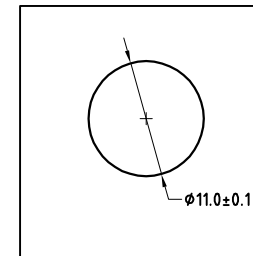
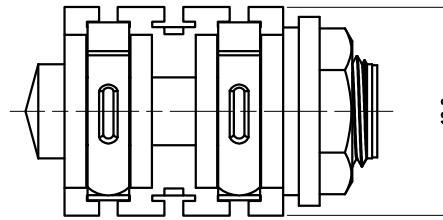
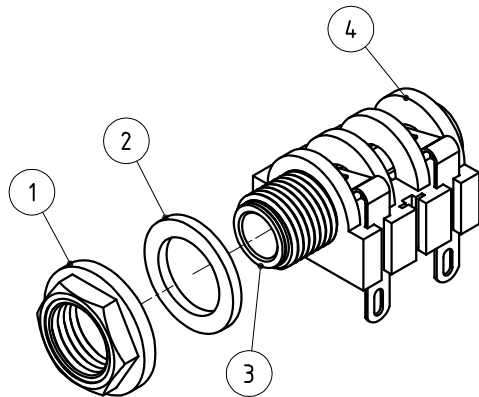
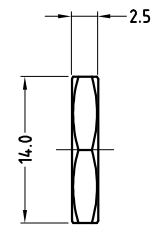

PANEL CUTOUT

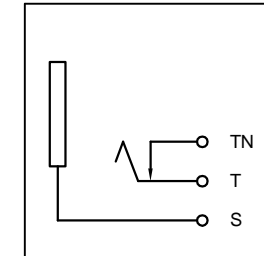

SCHEMATIC

ITEM	DESCRIPTION
1	METAL/PLASTIC NUT
2	FIBRE WASHER
3	METAL TUBE INSERT
4	CONNECTOR ASSEMBLY

PART No.	CATALOG No.	DESCRIPTION
55010292-000	ACJM-MHS	METAL NUT
55010292-001	ACJM-PHS	PLASTIC NUT

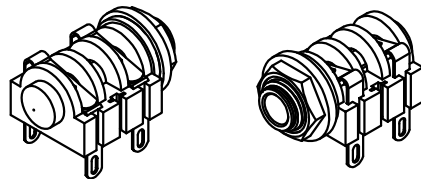

ISO VIEW

UNLESS OTHERWISE SPECIFIED TOLERANCE TO BE		THIS DOCUMENT IS THE PROPERTY OF AMPHENOL AUSTRALIA PTY. LTD.. NO PART THEREOF MAY BE REPRODUCED AND USED WITHOUT THE PRIOR WRITTEN CONSENT OF THE OWNER			
LINEAR	ANGULAR	CAD FILE:	55010292000111	DRN:	L.V
X ± 0.5	X° ± 1°	MATL:	REFER TO COMPONENT	CKD:	M.N.H
X.X ± 0.1	X°X' ± 30'	FINISH:	REFER TO COMPONENT	APP'D:	P.M
X.XX ± 0.05	X°X'X" ± 15"	DO NOT SCALE		DATE:	17-10-01
BREAK ALL SHARP EDGES AND REMOVE ALL BURRS		DATE:	13-01-06	DATE:	13-01-06
THIRD ANGLE PROJECTION		SCALE:	2:1 UOS	PART No:	REFER TO TABLE

1	CHANGE PART VARIATION NUMBER IN TABLE UPDATE DRAWING TO CURRENT PART	L.V	07-07-04	8293
0	FIRST ISSUE	L.V	17-10-01	----
REV.	CHANGE DETAILS	BY	DATE	CHG/No
TITLE: ACJM-MHS/ACJM-PHS 1/4" MONO JACK CUSTOMER DRAWING		Amphenol Australia Pty Ltd, 2 Frenways Blvd, Keysborough, Vic 3173		
DRAWING NO.		SHEET		
PART No: REFER TO TABLE		SIZE: A3	55010292-000-1 1 OF 1	

# Mouser Electronics

Authorized Distributor

Click to View Pricing, Inventory, Delivery & Lifecycle Information:

[Amphenol:](#)

[ACJM-MHS](#) [ACJS-MHS](#) [ACJM-PHS](#) [ACJS-PHS](#)