



## PRODUCT SPECIFICATION

Description: CRGH Series High Power Thick Film Chip Resistors

Product Type: (Resistance range: 1.0Ω ~ 10MΩ)

CRGH0603_XXX	(CRGH0603 1/5W +/- 1% & 5% Taped)
CRGH0805_XXX	(CRGH0805 1/3W +/- 1% & 5% Taped)
CRGH1206_XXX	(CRGH1206 1/2W +/- 1% & 5% Taped)
CRGH2010JXXX	(CRGH2010 1W +/- 1% & 5% Taped)
CRGH2512JXXX	(CRGH2512 2W +/- 1% & 5% Taped)



Parts corresponding to RoHS Compliant: 2005-Apr.-1



## High Power Thick Film Chip Resistors

### 1. Scope:

This specification relates to the Tyco Electronics Thick Film Chip Resistors (Lead Free)

### 2. Type designation:

The type designation shall be in the following form:

Ex.

Type	Power Rating	Resistance tolerance	Nominal Resistance
CRGH0603	1/5W	F (1%) J (5%)	1K0
CRGH0805	1/3W		
CRGH1206	1/2W		
CRGH2010	1W		
CRGH2512	2W		

### 3. Ratings:

Type	CRGH0603	CRGH0805	CRGH1206	CRGH2010	CRGH2512
Power Rating	0.20W	0.33W	0.50W	1.0W	2.0W
Max. Working Voltage	50 V	150 V	200 V	200 V	250 V
Max. Overload Voltage	100 V	300 V	400 V	400 V	500 V
Dielectric Withstanding Voltage	300 V	500 V	500 V	500 V	500 V
Temperature Range	-55°C ~ +155°C				
Ambient Temperature	70°C				

#### 3.1 Power rating:

Resistors shall have a power rating based on continuous load operation at an ambient temperature of 70°C. For temperature in excess of 70°C, the load shall be derate as shown in fig. 1.

Figure 1



#### 3.2 Voltage Rating:

Resistors shall have a rated direct-current (DC) continuous working voltage or an approximate sine-wave root-mean-square (RMS) alternating-current (AC) continuous working voltage at commercial-line frequency and waveform corresponding to the power rating, as determined from the following formula:

$$RCWV = \sqrt{P \times R}$$

Where : RCWV = Rated DC or RMS AC continuous working voltage at commercial-line frequency and waveform (volt)

P = Power Rating (watt)

R = Nominal Resistance (ohm)

In no case shall the rated DC or RMS AC continuous working voltage be greater than the applicable maximum value.

### High Power Thick Film Chip Resistors

4. Construction :



5. Power rating and dimensions



Dimension :

Type	Dimension (mm)				
	L	W	H	l1	l2
CRGH0603	1.60 ± 0.10	0.80 + 0.15 - 0.10	0.45 ± 0.10	0.30 ± 0.20	0.30 ± 0.20
CRGH0805	2.00 ± 0.15	1.25 + 0.15 - 0.10	0.55 ± 0.10	0.40 ± 0.20	0.40 ± 0.20
CRGH1206	3.10 ± 0.15	1.55 + 0.15 - 0.10	0.55 ± 0.10	0.45 ± 0.20	0.45 ± 0.20
CRGH2010	5.00 ± 0.20	2.50 ± 0.15	0.55 ± 0.10	0.60 ± 0.25	0.50 ± 0.20
CRGH2512	6.35 ± 0.10	3.20 ± 0.15	0.55 ± 0.10	0.60 ± 0.25	1.80 ± 0.20

Power Rating :

Type	Power Rating at 70°C	Tolerance %	Resistance Range	Standard Series	TCR
CRGH0603	0.20W	± 1	1Ω ~ 10MΩ	E-96	≤ 10Ω ±200PPM/°C <
		± 5	1Ω ~ 10MΩ	E-24	10Ω ±100PPM/°C
CRGH0805	0.33W	± 1	1Ω ~ 10MΩ	E-96	≤ 10Ω ±200PPM/°C <
		± 5	1Ω ~ 10MΩ	E-24	
CRGH1206	0.50W	± 1	1Ω ~ 10MΩ	E-96	≤ 10Ω ±200PPM/°C <
		± 5	1Ω ~ 10MΩ	E-24	
CRGH2010	1.00W	± 1	1Ω ~ 10MΩ	E-24	< 10Ω ±200PPM/°C <
		± 5	1Ω ~ 10MΩ		
CRGH2512	2.00W	± 1	1Ω ~ 9.76Ω	E-96	< 10Ω ±200PPM/°C <
		± 5	1.1MΩ ~ 10MΩ	E-24	

**High Power Thick Film Chip Resistors**

5.1 PCB Layout Plan:



Dimension :

Type	Dimension (mm)		
	A	B	C
CRGH0603	1.00	1.00	0.60
CRGH0805	1.30	1.20	1.00
CRGH1206	1.80	1.20	2.20
CRGH2010	3.00	1.50	3.80
CRGH2512	3.50	1.90	5.00

## High Power Thick Film Chip Resistors

### 6. Marking :

#### 6.1 Resistors

A.  $\pm 5\%$  Tolerance : the first two digits are significant figures of resistance and the third denoted number of zeros.

Ex. 

	333	
--	-----	--

 33K $\Omega$

B. For ohmic values below 10  $\Omega$ , read letter "R" as decimal point.

Ex. 

	2R2	
--	-----	--

 2.2 $\Omega$

C. For E-96 series [ $\pm 1\%$  (F) tolerance] in CRGH0603 size 3 digit system (due to space restrictions) please refer to page 4. for coding formula

Ex. 

	02C	
--	-----	--

 10.2K $\Omega$

D.  $\pm 1\%$  Toler CRGH0805\_XXX (CRGH0805 1/3W +/- 1% & 5% Taped)

resistance and the fourth digit denoted number of zeros. Letter "R" is for decimal point.

Ex. 

CRGH	2701	
------	------	--

 2.7K $\Omega$

	10R5	
--	------	--

 10.5 $\Omega$



#### 6.2 Labels

Label shall be marked with the following item :

Label shall be marked with the following item :

- A. Nominal Resistance and Resistance Tolerance
- B. Power Rating and Size
- C. Quantity
- D. Part No.
- E. P.O.No.
- F. Lot No.

Ex.

<b>tyco</b> / Electronics		
CHIP RESISTORS		
RESISTANCE: 330K	$\Omega$	$\pm 5\%$
WATTAGE: 1/2W	SIZE: CRGH0603	
QUANTITY: 5,000	PCS	Pb-Free
PART NO.: CRGH0603F330K	RoHS	2002/95/EC
LOT NO. : 825723	REF #	2456319325
		

Remark : **For CRGH0603**  $\pm 1\%$  : Label is 332K, value is 332K $\Omega$ , marking is 51D

$\pm 5\%$  : Label is 330K, value is 330K $\Omega$ , marking is 334

$\pm 1\%$  : Label is 330K, value is 330K $\Omega$ , marking is 3303

Customer:

Part No.: CRGH Series

**High Power Thick Film Chip Resistors**

**Mutiplier Code :**

Code	A	B	C	D	E	F	G	H	X	Y	Z
Multiplier	0	1	2	3	4	5	6	7	-1	-2	-3
	10	10	10	10	10	10	10	10	10	10	10

**Coding**

**Formula**

**Example :** 10K2 = 102 X 10<sup>2</sup> = 02C



Resistance Code

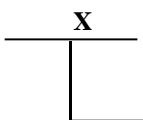

Multiplier Code

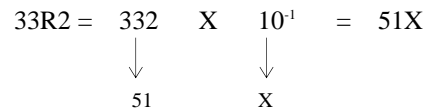

Value	Code	Value	Code	Value	Code	Value	Code	Value	Code
100	01	162	21	261	41	422	61	681	81
102	02	165	22	267	42	432	62	698	82
105	03	169	23	274	43	442	63	715	83
107	04	174	24	280	44	453	64	732	84
110	05	178	25	287	45	464	65	750	85
113	06	182	26	294	46	475	66	768	86
115	07	187	27	301	47	487	67	787	87
118	08	191	28	309	48	499	68	806	88
121	09	196	29	316	49	511	69	825	89
124	10	200	30	324	50	523	70	845	90
127	11	205	31	332	51	536	71	866	91
130	12	210	32	340	52	549	72	887	92
133	13	215	33	348	53	562	73	909	93
137	14	221	34	357	54	576	74	931	94
140	15	226	35	365	55	590	75	953	95
143	16	232	36	374	56	604	76	976	96
147	17	237	37	383	57	619	77		
150	18	243	38	392	58	634	78		
154	19	249	39	402	59	649	79		
158	20	255	40	412	60	665	80		

\*Marking for CRGH0603 E-96 series, the resistance value that no have multiplier code indicate marking follow this:  
 The first two digits are significant figures of resistance and the third one denoted number of zeros and under line the marking letters.

Ex.

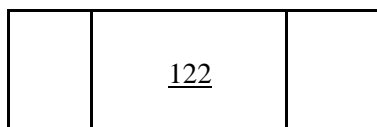

1.2KΩ

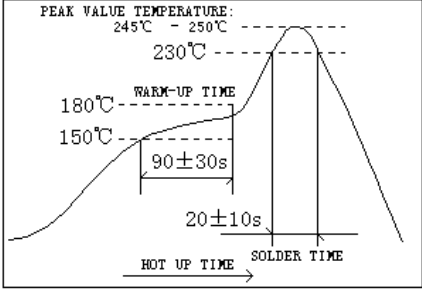
<b>Customer:</b>		<b>Part No.: CRGH Series</b>															
<b>High Power Thick Film Chip Resistors</b>																	
<b>7. Performance specification :</b>																	
Characteristics	Limits	Test Methods ( JIS C 5201-1 )															
Dielectric withstanding voltage	No evidence of flashover mechanical damage, arcing or insulation break down	4.7 Clamped in the trough of a 90°C metallic v-block and shall be tested at ac potential respectively specified in the type for 60-70 seconds															
Temperature Coefficient	See Page 2	4.8 Natural resistance change per temp. degree centigrade. $\frac{R2-R1}{R1(t2-t1)} \times 10^6 \quad (\text{PPM}/^\circ\text{C})$ R1: Resistance value at room temperature (T1) R2: Resistance value at room temp. plus 100°C (T2) Test pattern: room temp. (T1), room temp. +100°C (T2)															
Short time Overload	Resistance change rate is ± 5% (2.0% + 0.1Ω) Max. ± 1% (1.0% + 0.1Ω) Max.	4.13 Permanent resistance change after the application of a potential of 2.5 times RCWV for 5 seconds.															
Solderability	95 % coverage Min.	Wave Solder: Test temperature of solder: 245°C ±3°C dipping time in solder : 2-3 seconds. Reflow Solder:  <p>The graph shows a temperature profile for reflow soldering. The y-axis is temperature in °C (50 to 250) and the x-axis is time. Key points include: 150°C at 90 ± 30s (WARM-UP TIME), 180°C, 230°C, and a peak value temperature between 245°C and 250°C. The SOLDER TIME is indicated as 20 ± 10s.</p>															
Soldering heat	Resistance change rate is: ±(1%+0.05Ω) Max.	4.18 Dip the resistor into a solder bath having a temperature of 260°C ± 3°C and hold it for 10 ± 1 seconds.															
Temperature cycling	Resistance Change Rate Is ± 5% (1.0% + 0.05Ω) Max. ± 1% (0.5% + 0.05Ω) Max.	4.19 Resistance change after continuous 5 cycles for duty cycle specified below :															
		<table border="1"> <thead> <tr> <th>Step</th> <th>Temperature</th> <th>Time</th> </tr> </thead> <tbody> <tr> <td align="center">1</td> <td align="center">-55°C ± 3°C</td> <td align="center">30 mins</td> </tr> <tr> <td align="center">2</td> <td align="center">Room temp.</td> <td align="center">10 ~ 15 mins</td> </tr> <tr> <td align="center">3</td> <td align="center">+155°C ± 2°C</td> <td align="center">30 mins</td> </tr> <tr> <td align="center">4</td> <td align="center">Room temp.</td> <td align="center">10 ~ 15 mins</td> </tr> </tbody> </table>	Step	Temperature	Time	1	-55°C ± 3°C	30 mins	2	Room temp.	10 ~ 15 mins	3	+155°C ± 2°C	30 mins	4	Room temp.	10 ~ 15 mins
		Step	Temperature	Time													
		1	-55°C ± 3°C	30 mins													
		2	Room temp.	10 ~ 15 mins													
3	+155°C ± 2°C	30 mins															
4	Room temp.	10 ~ 15 mins															
Humidity	Resistance change rate is ± 5% (3.0% + 0.1Ω) Max. ± 1% (1.0% + 0.1Ω) Max.	4.24 Temporary resistance change after 240 hours exposure in a humidity test chamber controlled at 40±2°C and 90-95% relative humidity															
Load life in Humidity	Resistance change rate is ± 5% (3.0% + 0.1Ω) Max. ± 1% (1.0% + 0.1Ω) Max.	7.9 Resistance change after 1,000 hours (1.5 hours "on", 0.5 hour "off" ) at RCWV in a humidity chamber controlled at 40°C ± 2°C and 90 to 95% relative humidity															
Load Life	Resistance change rate is ± 5% (3.0% + 0.1Ω) Max. ± 1% (1.0% + 0.1Ω) Max.	4.25.1 Permanent resistance change after 1,000 hours operating at RCWV, with duty cycle of (1.5 hours "on", 0.5 hour "off") at 70°C ± 2°C ambient															
Terminal Bending	Resistance change rate is ± (1.0% + 0.05Ω) Max.	4.33 Twist of Test Board : Y/X = 3/90 mm for 60 seconds															



**High Power Thick Film Chip Resistors**

**6. Packing specification :**

6.1 Taping Dimension (mm)

A. Paper tape



B. Plastic tape



Type	A ± 0.2	B ± 0.2	C ± 0.05	$\phi D +0.1$ - 0	E ± 0.1	F ± 0.05	G ± 0.1	W ± 0.2	T ± 0.1
CRGH0603	1.10	1.90	2.0	1.5	1.75	3.5	4.0	8.0	0.67
CRGH0805	1.65	2.40	2.0	1.5	1.75	3.5	4.0	8.0	0.81
CRGH1206	2.00	3.60	2.0	1.5	1.75	3.5	4.0	8.0	0.81
CRGH2010	2.80	5.50	2.0	1.5+0.25	1.75	5.5	4.0	12.0	1.2±0.0
CRGH2512	3.60	6.90	2.0	1.5+0.25	1.75	5.5	4.0	12.0	1.2±0.0

7.2 Reel Dimension (mm)

A. Paper tape

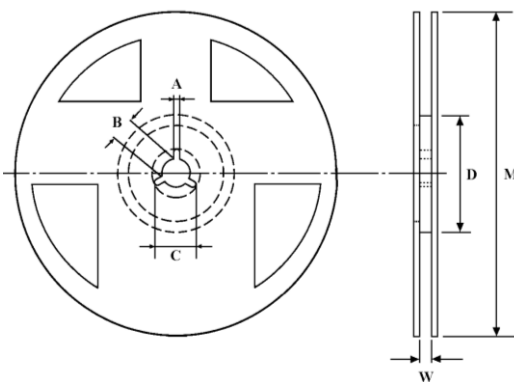

B. Plastic tape



Type	Packaging	Quantity Per Reel	A	B	C	D	M ± 2	W ± 1	T ± 1
CRGH0603	Paper	5,000 pcs.	2±0.5	13±0.5	21±0.5	60±1.0	178±2.0	10±1.0	-
CRGH0805	Paper	5,000 pcs.	2±0.5	13±0.5	21±0.5	60±1.0	178±2.0	10±1.0	-
CRGH1206	Paper	5,000 pcs.	2±0.5	13±0.5	21±0.5	60±1.0	178±2.0	10±1.0	-
CRGH2010	Plastic	4,000 pcs.	180-3.0	60+1.0	13±0.2	-	-	13.5±0.5	15.4±1.0
CRGH2512	Plastic	4,000 pcs.	180-3.0	60+1.0	13±0.2	-	-	13.5±0.5	15.4±1.0

**High Power Thick Film Chip Resistors**

**Part Number System**

**Explanation of Part Number System**

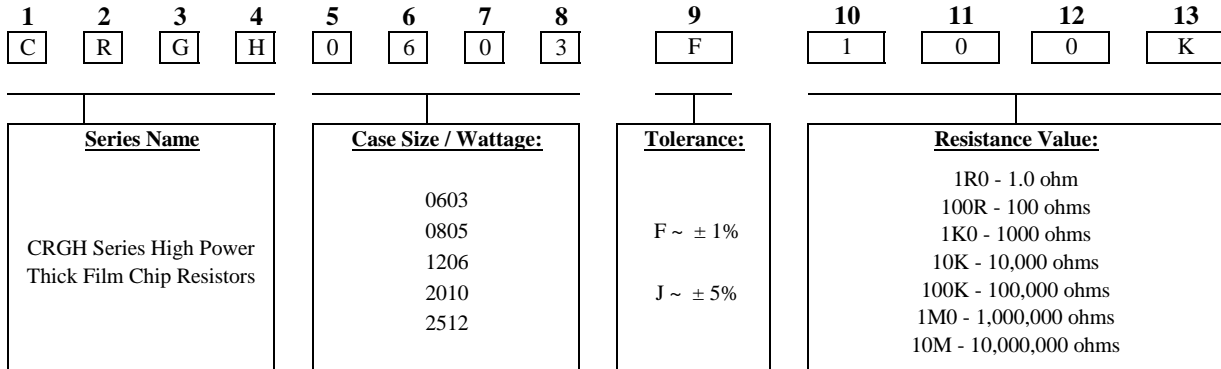

CRGH0805\_XXX (CRGH0805 1/3W +/- 1% & 5% Taped)

CRGH2512JXXX (CRGH2512 2W +/- 1% & 5% Taped)

# Mouser Electronics

Authorized Distributor

Click to View Pricing, Inventory, Delivery & Lifecycle Information:

## TE Connectivity:

[CRGH1206F180K](#) [CRGH0805F27R](#) [CRGH0805F2K2](#) [CRGH0805F180K](#) [CRGH1206F33K](#) [CRGH1206F220K](#)  
[CRGH0805F270R](#) [CRGH1206F680K](#) [CRGH0603F270R](#) [CRGH0603F470R](#) [CRGH0603F680K](#) [CRGH0603F120R](#)  
[CRGH0603F180K](#) [CRGH0603F3K3](#) [CRGH0805F470K](#) [CRGH1206F1K8](#) [CRGH0603F47K](#) [CRGH0603F39R](#)  
[CRGH0603F18R](#) [CRGH1206F220R](#) [CRGH0603F1K2](#) [CRGH0805F2K7](#) [CRGH0603F6K8](#) [CRGH0603F180R](#)  
[CRGH0805F8K2](#) [CRGH0603F27K](#) [CRGH1206F120R](#) [CRGH0603F33K](#) [CRGH1206F330K](#) [CRGH0805F56K](#)  
[CRGH0603F330K](#) [CRGH0603F39K](#) [CRGH0805F18K](#) [CRGH0603F4K7](#) [CRGH1206F1K2](#) [CRGH0603F12K](#)  
[CRGH1206F820K](#) [CRGH1206F470R](#) [CRGH1206F390K](#) [CRGH1206F39K](#) [CRGH0603F56R](#) [CRGH0805F4K7](#)  
[CRGH0805F68R](#) [CRGH0805F220K](#) [CRGH1206F22K](#) [CRGH0603F2K7](#) [CRGH0603F820R](#) [CRGH0603F3K9](#)  
[CRGH0603F330R](#) [CRGH0603F5K6](#) [CRGH1206F18K](#) [CRGH0805F47R](#) [CRGH0805F820R](#) [CRGH1206F390R](#)  
[CRGH1206F18R](#) [CRGH1206F12K](#) [CRGH0603F1K8](#) [CRGH0805F180R](#) [CRGH1206F2K7](#) [CRGH0805F6K8](#)  
[CRGH0603F47R](#) [CRGH1206F47R](#) [CRGH1206F12R](#) [CRGH1206F3K9](#) [CRGH0603F8K2](#) [CRGH0805F560R](#)  
[CRGH0603F27R](#) [CRGH0805F12R](#) [CRGH1206F22R](#) [CRGH0603F390R](#) [CRGH0603F82K](#) [CRGH0603F220R](#)  
[CRGH0603F68R](#) [CRGH1206F47K](#) [CRGH1206F270K](#) [CRGH0805F470R](#) [CRGH0805F120R](#) [CRGH0805F220R](#)  
[CRGH1206F2K2](#) [CRGH0603F33R](#) [CRGH1206F270R](#) [CRGH0603F120K](#) [CRGH0805F47K](#) [CRGH0603F18K](#)  
[CRGH0805F22K](#) [CRGH1206F3K3](#) [CRGH0603F68K](#) [CRGH0805F22R](#) [CRGH0603F220K](#) [CRGH1206F820R](#)  
[CRGH0603F680R](#) [CRGH0805F18R](#) [CRGH0805F39K](#) [CRGH0805F330R](#) [CRGH1206F560K](#) [CRGH1206F33R](#)  
[CRGH0603F560R](#) [CRGH0603F22R](#) [CRGH0603F82R](#) [CRGH0603F22K](#)