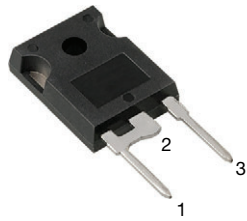
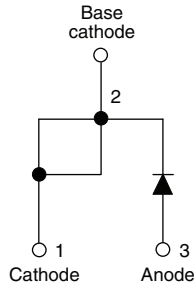

High Voltage, Input Rectifier Diode, 40 A

TO-247AC modified

FEATURES

- Very low forward voltage drop
- 150 °C max. operating junction temperature
- Glass passivated pellet chip junction
- Designed and qualified according to JEDEC®-JESD 47
- Material categorization: for definitions of compliance please see www.vishay.com/doc?99912

RoHS
 COMPLIANT
 HALOGEN
FREE
 Available

PRODUCT SUMMARY	
Package	TO-247AC modified (2 pins)
$I_{F(AV)}$	40 A
V_R	800 V to 1200 V
V_F at I_F	1.1 V
I_{FSM}	475 A
T_J max.	150 °C
Diode variation	Single die

APPLICATIONS

- Input rectification
- Vishay Semiconductors switches and output rectifiers which are available in identical package outlines

DESCRIPTION

High voltage rectifiers optimized for very low forward voltage drop with moderate leakage.

These devices are intended for use in main rectification (single or three phase bridge).

MAJOR RATINGS AND CHARACTERISTICS			
SYMBOL	CHARACTERISTICS	VALUES	UNITS
$I_{F(AV)}$	Sinusoidal waveform	40	A
V_{RRM}	Range	800/1200	V
I_{FSM}		475	A
V_F	40 A, $T_J = 25\text{ °C}$	1.1	V
T_J		-40 to +150	°C

VOLTAGE RATINGS			
PART NUMBER	V_{RRM} , MAXIMUM PEAK REVERSE VOLTAGE V	V_{RSM} , MAXIMUM NON-REPETITIVE PEAK REVERSE VOLTAGE V	I_{RRM} AT 150 °C mA
VS-40EPS08PbF, VS-40EPS08-M3	800	900	1
VS-40EPS12PbF, VS-40EPS12-M3	1200	1300	

ABSOLUTE MAXIMUM RATINGS				
PARAMETER	SYMBOL	TEST CONDITIONS	VALUES	UNITS
Maximum average forward current	$I_{F(AV)}$	$T_C = 105\text{ °C}$, 180° conduction half sine wave	40	A
Maximum peak one cycle non-repetitive surge current	I_{FSM}	10 ms sine pulse, rated V_{RRM} applied	400	
		10 ms sine pulse, no voltage reapplied	475	
Maximum I^2t for fusing	I^2t	10 ms sine pulse, rated V_{RRM} applied	800	A ² s
		10 ms sine pulse, no voltage reapplied	1131	
Maximum $I^2\sqrt{t}$ for fusing	$I^2\sqrt{t}$	$t = 0.1\text{ ms to }10\text{ ms}$, no voltage reapplied	11 310	A ² √s



ELECTRICAL SPECIFICATIONS					
PARAMETER	SYMBOL	TEST CONDITIONS		VALUES	UNITS
Maximum forward voltage drop	V_{FM}	20 A, $T_J = 25\text{ }^\circ\text{C}$		1.0	V
		40 A, $T_J = 25\text{ }^\circ\text{C}$		1.1	
Forward slope resistance	r_t	$T_J = 150\text{ }^\circ\text{C}$		7.16	$m\Omega$
Threshold voltage	$V_{F(TO)}$			0.74	V
Maximum reverse leakage current	I_{RM}	$T_J = 25\text{ }^\circ\text{C}$	$V_R = \text{Rated } V_{RRM}$	0.1	mA
		$T_J = 150\text{ }^\circ\text{C}$		1.0	

THERMAL - MECHANICAL SPECIFICATIONS					
PARAMETER	SYMBOL	TEST CONDITIONS		VALUES	UNITS
Maximum junction and storage temperature range	T_J, T_{Stg}			-40 to +150	$^\circ\text{C}$
Maximum thermal resistance, junction to case	R_{thJC}	DC operation		0.6	$^\circ\text{C/W}$
Maximum thermal resistance, junction to ambient	R_{thJA}			40	
Typical thermal resistance, case to heatsink	R_{thCS}	Mounting surface, flat, smooth and greased		0.2	
Approximate weight				6	g
				0.21	oz.
Mounting torque	minimum			6 (5)	kgf · cm (lb · in)
	maximum			12 (10)	
Marking device			Case style TO-247AC modified (JEDEC)	40EPS08	
				40EPS12	

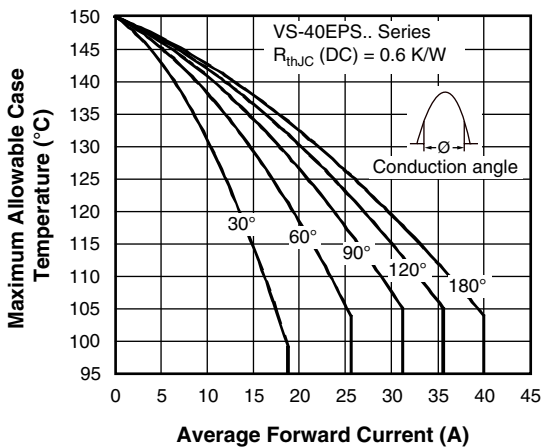

Fig. 1 - Current Rating Characteristics

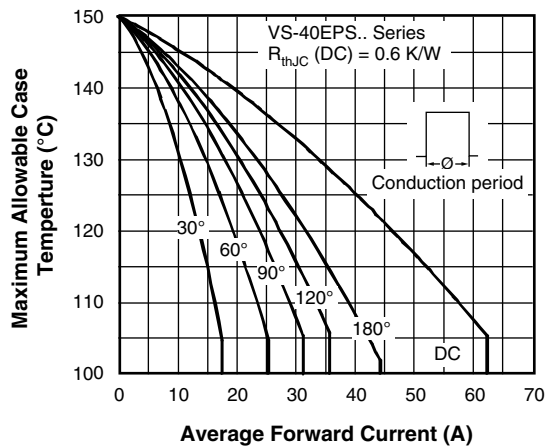

Fig. 2 - Current Rating Characteristics

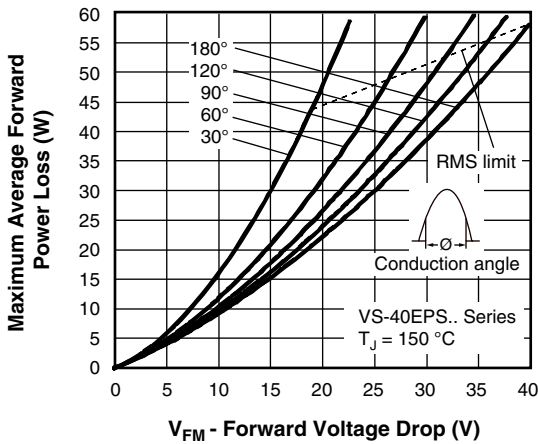

Fig. 3 - Forward Power Loss Characteristics

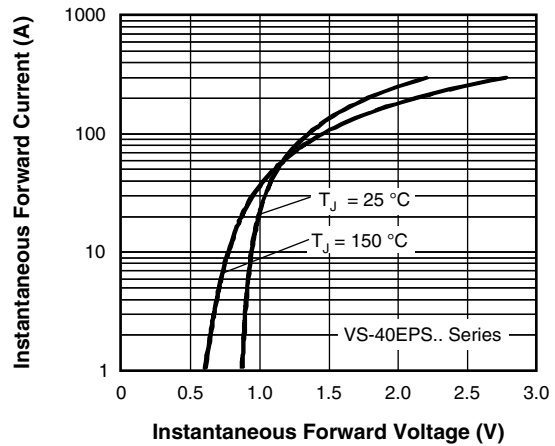

Fig. 5 - Forward Voltage Drop Characteristics

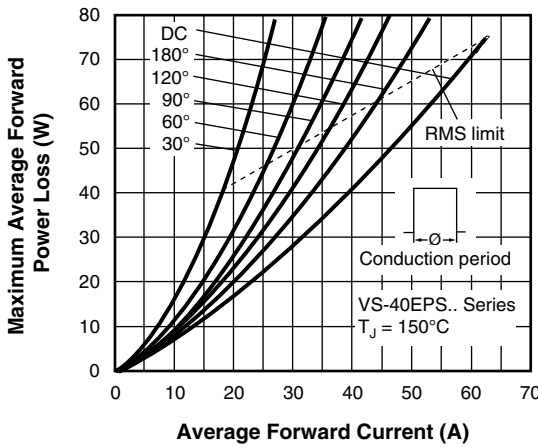

Fig. 4 - Forward Power Loss Characteristics

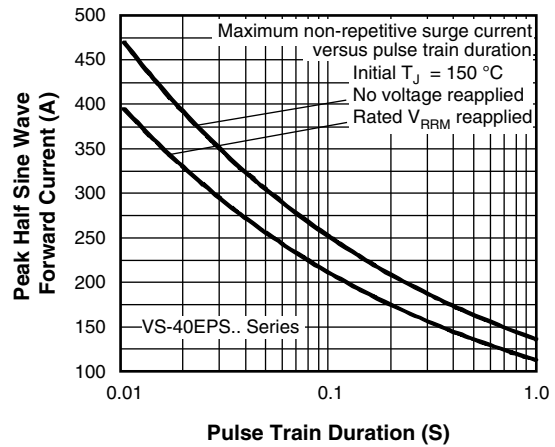

Fig. 6 - Maximum Non-Repetitive Surge Current

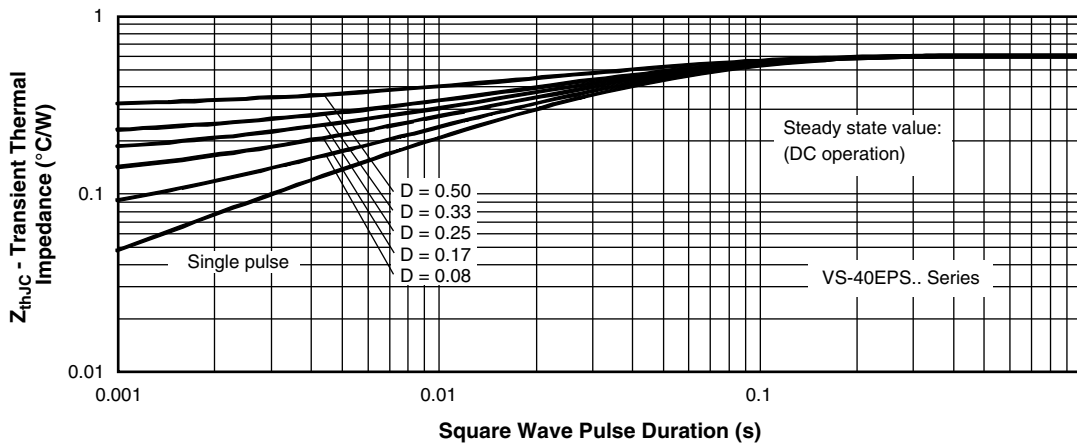
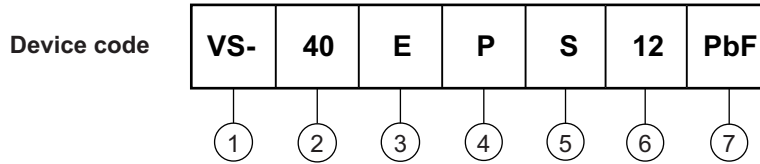

Fig. 7 - Thermal Impedance Z_{thJC} Characteristics



ORDERING INFORMATION TABLE



- 1** - Vishay Semiconductors product
- 2** - Current rating (40 = 40 A)
- 3** - Circuit configuration:
E = single diode
- 4** - Package:
P = TO-247AC modified
- 5** - Type of silicon:
S = standard recovery rectifier
- 6** - Voltage rating

08 = 800 V
12 = 1200 V
- 7** - Environmental digit:
PbF = lead (Pb)-free and RoHS-compliant
-M3 = halogen-free, RoHS-compliant, and terminations lead (Pb)-free

ORDERING INFORMATION (Example)			
PREFERRED P/N	QUANTITY PER T/R	MINIMUM ORDER QUANTITY	PACKAGING DESCRIPTION
VS-40EPS08PbF	25	500	Antistatic plastic tubes
VS-40EPS08-M3	25	500	Antistatic plastic tubes
VS-40EPS12PbF	25	500	Antistatic plastic tubes
VS-40EPS12-M3	25	500	Antistatic plastic tubes

LINKS TO RELATED DOCUMENTS	
Dimensions	www.vishay.com/doc?95541
Part marking information	TO-247AC modified PbF www.vishay.com/doc?95255
	TO-247AC modified -M3 www.vishay.com/doc?95442
SPIICE model	www.vishay.com/doc?96047



TO-247AC modified - 50 mils L/F

DIMENSIONS in millimeters and inches

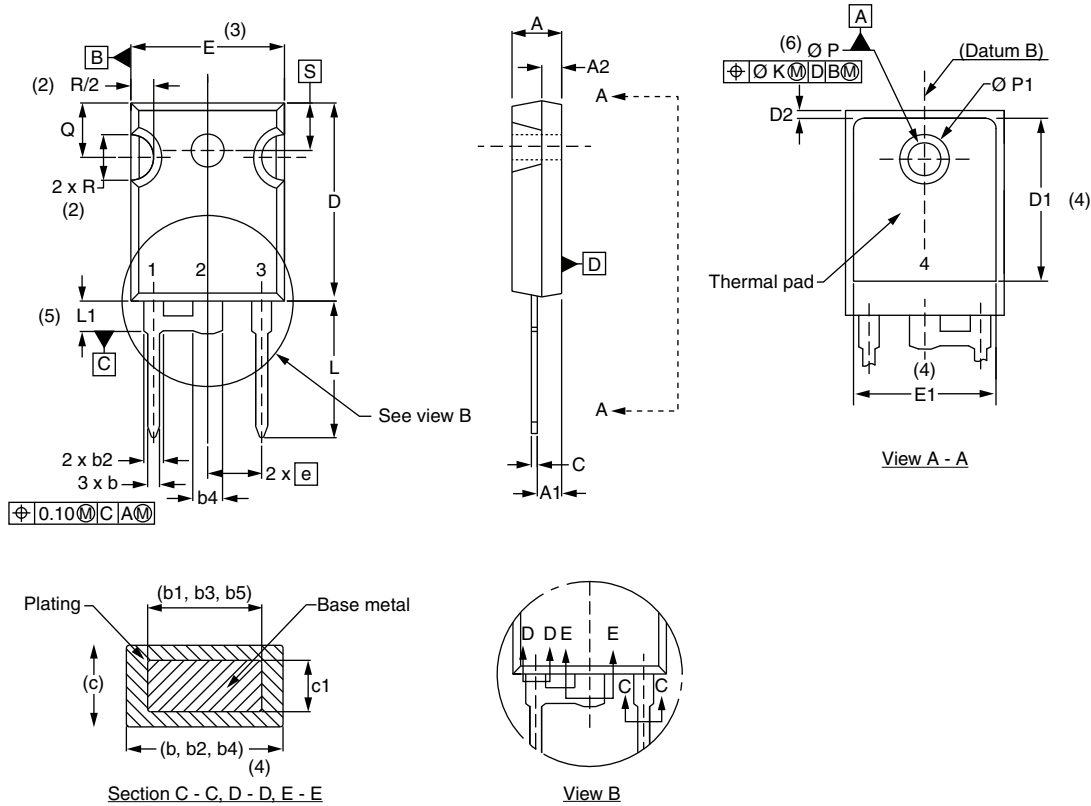

SYMBOL	MILLIMETERS		INCHES		NOTES	SYMBOL	MILLIMETERS		INCHES		NOTES
	MIN.	MAX.	MIN.	MAX.			MIN.	MAX.	MIN.	MAX.	
A	4.65	5.31	0.183	0.209		D2	0.51	1.35	0.020	0.053	
A1	2.21	2.59	0.087	0.102		E	15.29	15.87	0.602	0.625	3
A2	1.17	1.37	0.046	0.054		E1	13.46	-	0.53	-	
b	0.99	1.40	0.039	0.055		e	5.46 BSC		0.215 BSC		
b1	0.99	1.35	0.039	0.053		Ø K	0.254		0.010		
b2	1.65	2.39	0.065	0.094		L	14.20	16.10	0.559	0.634	
b3	1.65	2.34	0.065	0.092		L1	3.71	4.29	0.146	0.169	
b4	2.59	3.43	0.102	0.135		Ø P	3.56	3.66	0.14	0.144	
b5	2.59	3.38	0.102	0.133		Ø P1	-	7.39	-	0.291	
c	0.38	0.89	0.015	0.035		Q	5.31	5.69	0.209	0.224	
c1	0.38	0.84	0.015	0.033		R	4.52	5.49	0.178	0.216	
D	19.71	20.70	0.776	0.815	3	S	5.51 BSC		0.217 BSC		
D1	13.08	-	0.515	-	4						

Notes

- (1) Dimensioning and tolerance per ASME Y14.5M-1994
- (2) Contour of slot optional
- (3) Dimension D and E do not include mold flash. Mold flash shall not exceed 0.127 mm (0.005") per side. These dimensions are measured at the outermost extremes of the plastic body
- (4) Thermal pad contour optional with dimensions D1 and E1
- (5) Lead finish uncontrolled in L1
- (6) Ø P to have a maximum draft angle of 1.5 to the top of the part with a maximum hole diameter of 3.91 mm (0.154")
- (7) Outline conforms to JEDEC® outline TO-247 with exception of dimension c and Q



Disclaimer

ALL PRODUCT, PRODUCT SPECIFICATIONS AND DATA ARE SUBJECT TO CHANGE WITHOUT NOTICE TO IMPROVE RELIABILITY, FUNCTION OR DESIGN OR OTHERWISE.

Vishay Intertechnology, Inc., its affiliates, agents, and employees, and all persons acting on its or their behalf (collectively, "Vishay"), disclaim any and all liability for any errors, inaccuracies or incompleteness contained in any datasheet or in any other disclosure relating to any product.

Vishay makes no warranty, representation or guarantee regarding the suitability of the products for any particular purpose or the continuing production of any product. To the maximum extent permitted by applicable law, Vishay disclaims (i) any and all liability arising out of the application or use of any product, (ii) any and all liability, including without limitation special, consequential or incidental damages, and (iii) any and all implied warranties, including warranties of fitness for particular purpose, non-infringement and merchantability.

Statements regarding the suitability of products for certain types of applications are based on Vishay's knowledge of typical requirements that are often placed on Vishay products in generic applications. Such statements are not binding statements about the suitability of products for a particular application. It is the customer's responsibility to validate that a particular product with the properties described in the product specification is suitable for use in a particular application. Parameters provided in datasheets and / or specifications may vary in different applications and performance may vary over time. All operating parameters, including typical parameters, must be validated for each customer application by the customer's technical experts. Product specifications do not expand or otherwise modify Vishay's terms and conditions of purchase, including but not limited to the warranty expressed therein.

Except as expressly indicated in writing, Vishay products are not designed for use in medical, life-saving, or life-sustaining applications or for any other application in which the failure of the Vishay product could result in personal injury or death. Customers using or selling Vishay products not expressly indicated for use in such applications do so at their own risk. Please contact authorized Vishay personnel to obtain written terms and conditions regarding products designed for such applications.

No license, express or implied, by estoppel or otherwise, to any intellectual property rights is granted by this document or by any conduct of Vishay. Product names and markings noted herein may be trademarks of their respective owners.