

Features

Regulated Converter

- 80 to 305VAC input voltage range
- 150% peak power capability
- Wide temperature range: -40°C to +90°C
- No load power consumption <150mW
- Household and ITE certified
- 4kVac isolation
- Operating Altitude up to 5000m



RAC04-K/277

4 Watt Single Output



Description

The RAC04-K/277 series delivers an uncompromising 4 watts of continuous output power (6W peak) in harsh industrial and household environments. These modules deliver full load output power from -40°C to 75°C across the entire input range of 80VAC to 305VAC and are certified for operation with power derating up to 90°C air ambient. A peak load capability of up to 150% supports dynamic power demands of applications. This series of fully encapsulated AC/DC modules is a complete solution without the need for external components which supports Ecodesign Lot 6 standby mode operation for worldwide applications in automation, industry 4.0, IoT, household, and home automation. With international safety and EMC certifications for industrial, domestic, ITE, and household applications, these are some of the most versatile power modules on the market. Due to their reinforced class II installation rating for floating outputs and their significantly wide margin to class B emissions compliance without external components and a certified 4kV AC (5.75kV DC) isolation, these are the easiest to use modular power solutions in the industry.

Selection Guide

Part Number	Input Voltage Range [VAC]	Output Voltage [VDC]	Output Current [mA]	Efficiency typ. [%]	Max. Capacitive Load [µF]
RAC04-3.3SK/277	80-305	3.3	1200	73	10000
RAC04-05SK/277	80-305	5	800	76	7200
RAC04-12SK/277	80-305	12	333	78	1000
RAC04-15SK/277	80-305	15	267	80	820
RAC04-24SK/277	80-305	24	167	80	220

Notes:

Note1: Refer to "Line Derating" graph

Note2: Measured @ 230VAC/50Hz at +25°C with constant resistant mode at full load

Model Numbering

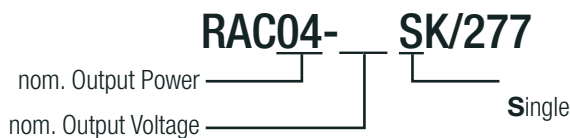

Ordering Examples

- RAC04-05SK/277 = 5Vout Single
- RAC04-12SK/277 = 12Vout Single

Specifications (measured @ Ta= 25°C, nom. Vin, full load and after warm-up unless otherwise stated)

BASIC CHARACTERISTICS				
Parameter	Condition	Min.	Typ.	Max.
Input Voltage Range ⁽³⁾	nom. Vin= 277VAC	80VAC 110VDC		305VAC 390VDC
Input Current	115VAC 230VAC			250mA 100mA
Inrush Current	cold start at +25°C	115VAC 230VAC		10A 20A
No load Power Consumption	80-305VAC, 50/60Hz		100mW	150mW
ErP Standby Mode Conformity (Output Load Capability)	Input Power=	0.5W 1W		0.3W 0.65W

continued on next page

- IEC60950-1 certified
- IEC62368-1 certified
- UL62368-1 certified
- CSA/CAN C22.2 No. 62368-1-14 certified
- EN62368-1 compliant
- EN60335-1 compliant
- EN61010-1 compliant
- IEC/EN61558-1 compliant
- IEC/EN61558-2-16 compliant
- EN55032 compliant
- EN55024 compliant
- EN55014-1 /-2 compliant
- IEC/EN61204-3 compliant
- FCC 47 Part 15
- CB Report

Specifications (measured @ Ta= 25°C, nom. Vin, full load and after warm-up unless otherwise stated)

BASIC CHARACTERISTICS (continuous)

Parameter	Condition	Min.	Typ.	Max.
Input Frequency Range	AC input	47Hz		63Hz
Start-up Time			20ms	
Rise Time			10ms	
Hold-up time	115VAC		20ms	
	230VAC		80ms	
Minimum Load		0%		
Power Factor	115VAC	0.6		
	230VAC	0.45		
Internal Operating Frequency	full load		130kHz	
Output Ripple and Noise ⁽⁴⁾				1% of nom. Vout

Notes:

Note3: The products were submitted for safety files at AC-Input operation

Note4: Measurements are made with a 1.0µF MLCC and a 10µF MLCC across output

Efficiency vs. Load

RAC04-3.3SK/277

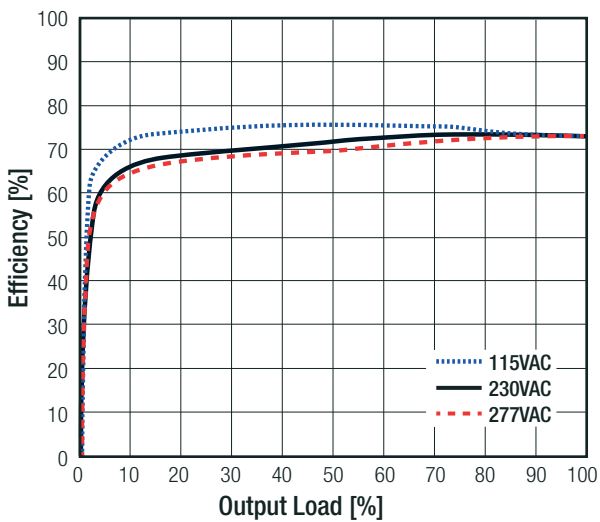

RAC04-05SK/277

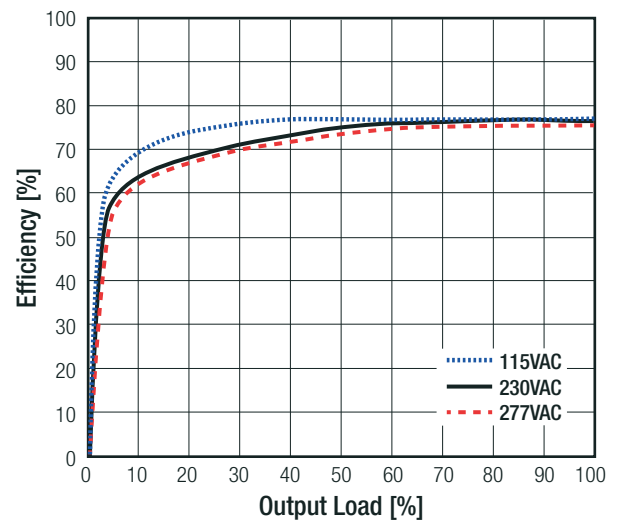

RAC04-12SK/277

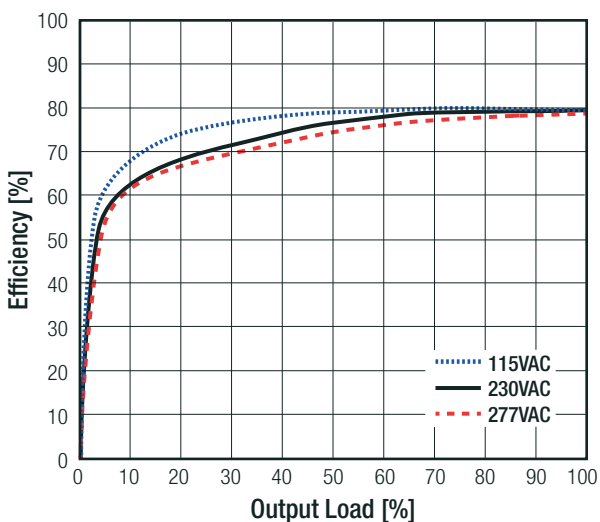

RAC04-15SK/277

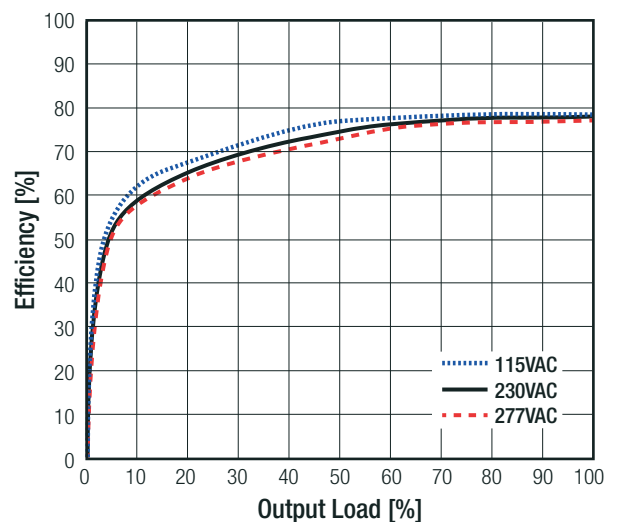

continued on next page

Specifications (measured @ Ta= 25°C, nom. Vin, full load and after warm-up unless otherwise stated)

Efficiency vs. Load

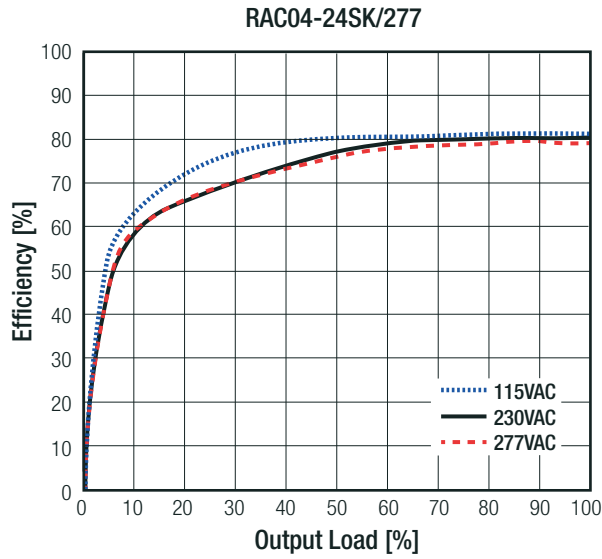

REGULATIONS

Parameter	Condition	Value
Output Accuracy		±1.0% typ.
Line Regulation		±0.5% typ.
Load Regulation		1.0% typ.
Transient Response	25% load step change recovery time	4.0% max. 500µs

Deviation vs. Load
(80-305VAC)

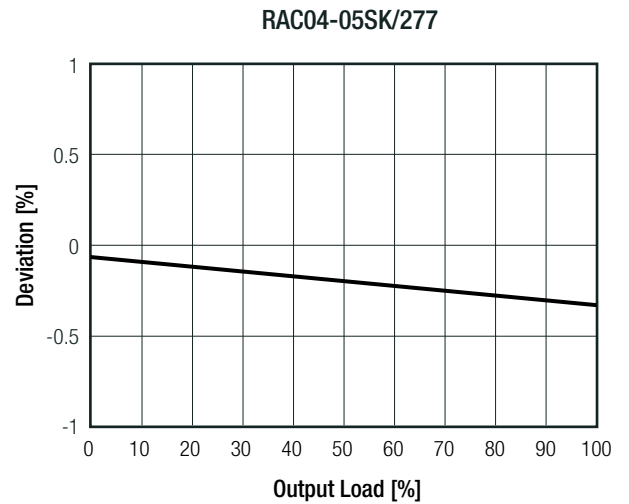
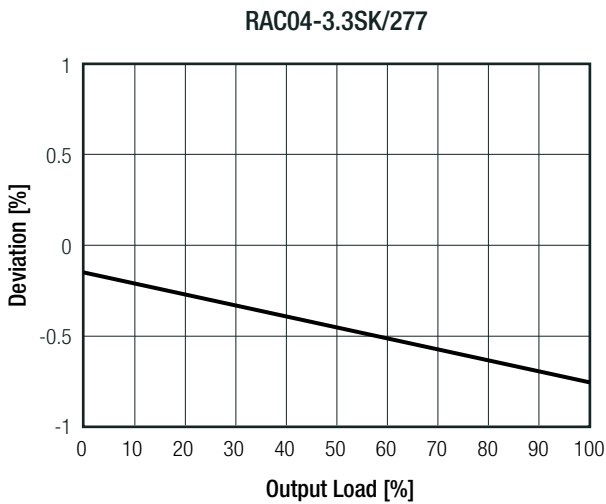

continued on next page

Specifications (measured @ Ta= 25°C, nom. Vin, full load and after warm-up unless otherwise stated)

Deviation vs. Load

(80-305VAC)

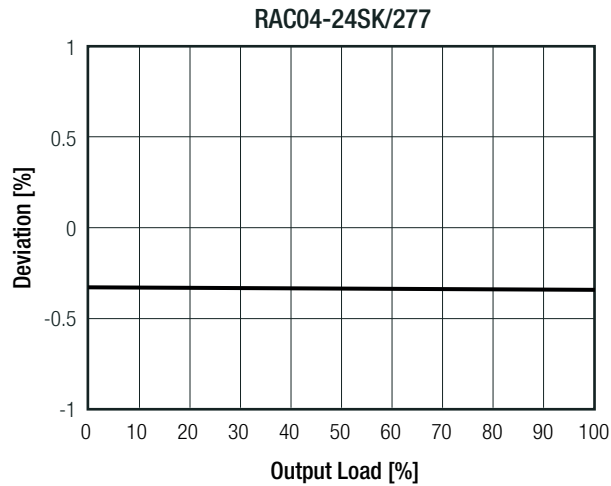
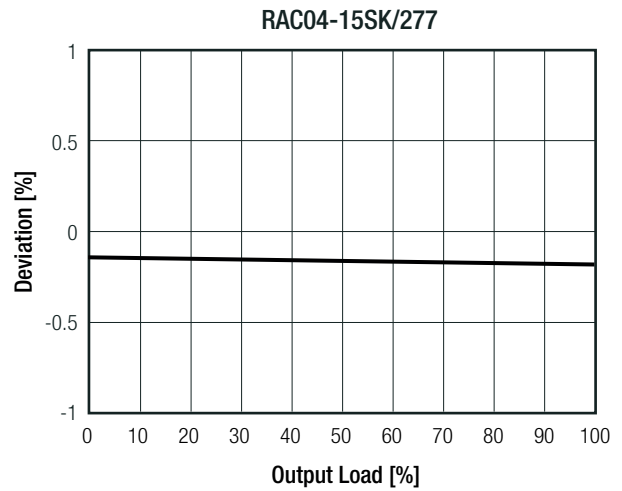
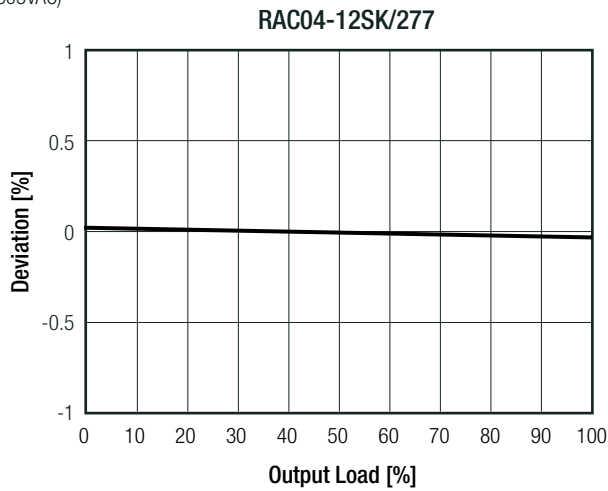

PROTECTIONS

Parameter	Type		Value
Input Fuse ⁽⁵⁾	internal		T1A, slow blow
Short Circuit Protection (SCP)			Hiccup Mode, auto recovery
Over Voltage Protection (OVP)			125% - 195%, Hiccup Mode
Over Voltage Category (OVC)			OVCII
Over Current Protection (OCP)			150% - 210%, Hiccup Mode
Class of Equipment			Class II
Isolation Voltage (safety certified) ⁽⁶⁾	I/P to O/P	1 minute	5.75kVDC 4kVAC
Isolation Resistance	Viso= 500VDC		1GΩ min.
Isolation Capacitance	I/P to O/P	100kHz, 0.1V	100pF max.
Insulation Grade			reinforced
Leakage Current			0.25mA max.

Notes:

Note5: Refer to local safety regulations if input over-current protection is also required. Recommended fuse: slow blow type

Note6: For repeat Hi-Pot testing, reduce the time and/or the test voltage.

continued on next page

Specifications (measured @ Ta= 25°C, nom. Vin, full load and after warm-up unless otherwise stated)

Peak Load Capability ⁽⁷⁾

Peak Load Calculation

- P_{nom} = nom. output power [W]
- P_p = peak output power (6W max.) [W]
- P_r = recovery output power [W]
- t_1 = peak time set (10s max.) [s]
- t_2 = recovery time (min. 4 x t_1) [s]
- k = safety factor 1.3 []

$$P_r = \frac{P_{nom} \times (t_1 + t_2) - P_p \times t_1}{t_2 \times k}$$

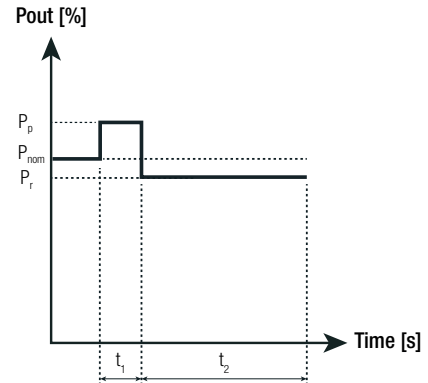

Practical Example:

Take the RAC04-05SK/277 at 230VAC input Voltage and full load at $T_{AMB} = 50^\circ\text{C}$ (4W).

- P_{nom} = please refer to derating graph (4W)
- P_p = 6W
- t_1 = 10s
- t_2 = min. 4 x t_1
- k = 1.3

$$P_r = \frac{4 \times (10 + 4 \times 10) - (6 \times 10)}{4 \times 10 \times 1.3} = \underline{\underline{2.69W}}$$

Notes:

Note7: Peak load calculation valid for 100-305VAC

ENVIRONMENTAL

Parameter	Condition		Value
Operating Temperature Range	@ natural convection 0.1m/s	full load	-40°C to +75°C
		refer to "Derating Graph"	-40°C to +90°C
Maximum Case Temperature			+100°C
Temperature Coefficient			±0.02%/K
Operating Altitude ⁽⁸⁾	according to IEC62368-1 (EN60335-1)		5000m (4000m)
Operating Humidity	non-condensing		20% - 95%, RH max.
Pollution Degree			PD2
Vibration	according to MIL-STD-202G		10-500Hz, 2G 10min. / 1 cycle, periode 60min. each along x, y, z axis
MTBF	according to MIL-HDBK-217F, G.B	+25°C	>2271 x 10 ³ hours
		+40°C	>1696 x 10 ³ hours
Design Lifetime	230VAC	+25°C	125 x 10 ³ hours
		+70°C	51 x 10 ³ hours
	277VAC	+25°C	105 x 10 ³ hours
		+70°C	37 x 10 ³ hours

Notes:

Note8: Recognized by safety agency for safe operation up to 5000m. High altitude operation may impact the performance and lifetime. Please contact RECOM tech support for advice.

Derating Graph

(@ Chamber and natural convection 0.1m/s)

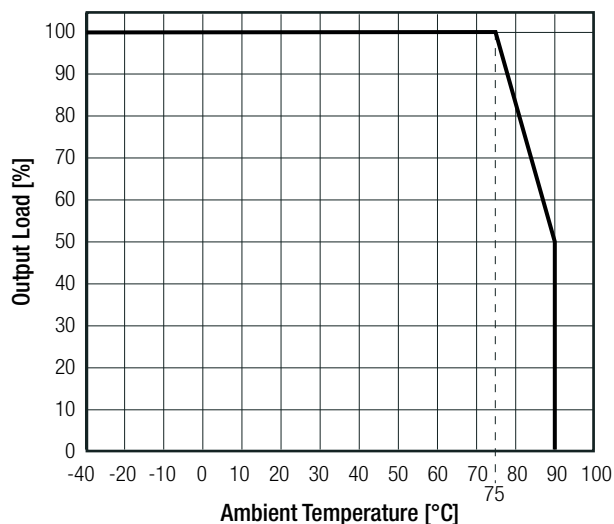

Line Derating

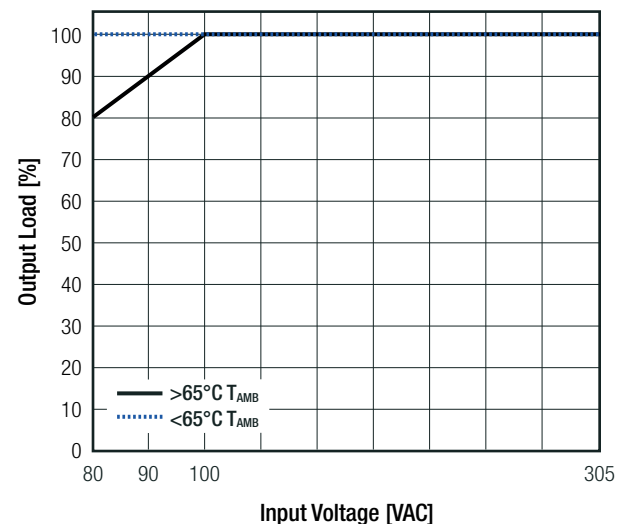

Specifications (measured @ Ta= 25°C, nom. Vin, full load and after warm-up unless otherwise stated)

SAFETY AND CERTIFICATIONS		
Certificate Type	Report Number	Standard
Audio/video, information and communication technology equipment - Safety requirements	E224736	UL62368-1:2014, 2nd Edition CAN/CSA C22.2 No. 62368-1-14, 2nd Edition
Information Technology Equipment, General Requirements for Safety (CB)	E491408-A6-CB-1	IEC60950-1:2005 + A2:2013, 2nd Edition
Information Technology Equipment, General Requirements for Safety		EN60950-1:2006 + A2:2013
Audio/video, information and communication technology equipment - Safety requirements (CB)	E491408-A6011-CB-1	IEC62368-1:2014, 2nd Edition
Audio/video, information and communication technology equipment - Safety requirements (LVD)		EN62368-1:2014 + A11:2017
Household and similar electrical appliances - Safety - Part 1: General requirements (LVD)		EN60335-1:2012 + A1:2018
Safety of power transformers, power supplies, reactors and similar products for supply voltages up to 1100 V		IEC61558-1:2005 2nd Edition + A1:2009 EN61558-1:2005 + A1:2009
Safety of transformers, reactors, power supply units and similar products for supply voltages up to 1100 V - Part 2-16: Particular requirements and tests for switch mode power supply units and transformers for switch mode power supply units (LVD)		IEC61558-2-16:2009 + A1:2013, 1st Edition EN61558-2-16:2009 + A1:2013
Safety requirements for electrical equipment for measurement, control and laboratory use - Part 1: General requirements (LVD)		EN61010-1:2010
RoHS2		RoHS-2011/65/EU + AM-2015/863
EMC Compliance (Household)		
Report / File Number	Standard / Criterion	
Electromagnetic compatibility - Requirements for household appliances, electric tools and similar apparatus - Part 1: Emission [®]	EN55014-1:2006 + A2:2011	
Electromagnetic compatibility - Requirements for household appliances, electric tools and similar apparatus - Part 2: Immunity	EN55014-2:2015	
ESD Electrostatic discharge immunity test	Air ±8kV; Contact ±4kV	IEC61000-4-2:2008, Criteria B
Fast Transient and Burst Immunity	AC Power Port: ±1.0kV	IEC61000-4-4:2012, Criteria B
Surge Immunity	AC Power Port: L-N ±1.0kV	IEC61000-4-5:2014, Criteria B
Immunity to conducted disturbances, induced by radio-frequency fields	AC Power Port: 3V	EN61000-4-6:2013, Criteria A
Voltage Dips and Interruptions	Voltage Dips: 100%	EN61000-4-11:2004, Criteria C
	60%	EN61000-4-11:2004, Criteria C
EMC Compliance (Multimedia)		
Condition	Standard / Criterion	
Low voltage power supplies, d.c. output - Part 3: Electromagnetic compatibility	IEC/EN61204-3:2000, Class B	
Electromagnetic compatibility of multimedia equipment - Emission requirements [®]	EN55032:2015, Class B	
Information technology equipment - Immunity characteristics - Limits and methods of measurement	EN55024:2010 + A1:2015	
ESD Electrostatic discharge immunity test	Air ±2,4,8kV; Contact ±4kV	IEC61000-4-2:2008, Criteria B
	10V/m (80 - 1000MHz)	IEC61000-4-3, Criteria A
Radiated, radio-frequency, electromagnetic field immunity test	3V/m (1800MHz, 2600Mhz, 3500MHz, 5000MHz)	IEC61000-4-3:2006 + A2:2010, Criteria A
	AC Power Port: ±2.0kV	IEC61000-4-4, Criteria B
Fast Transient and Burst Immunity	AC Power Port: ±1.0kV	IEC61000-4-4:2012, Criteria A
	AC Power Port: L-N ±1.0kV	IEC61000-4-5:2014, Criteria A
Surge Immunity	AC Power Port: L-N ±1.0kV	IEC61000-4-5:2014, Criteria A
Immunity to conducted disturbances, induced by radio-frequency fields	AC Power Port: 10V	IEC61000-4-6, Criteria A
Voltage Dips and Interruptions	100% / 30%	IEC61000-4-11:2004, Criteria A
	70%	IEC61000-4-11:2004, Criteria B
	40%	IEC61000-4-11:2004, Criteria C
	Interruptions: >95%	IEC61000-4-11:2004, Criteria A
Limits of Voltage Fluctuations & Flicker		EN61000-3-3:2013
Limitations on the amount of electromagnetic interference allowed from digital and electronic devices		FCC 47 Part 15 Subpart B:2017, Class B
Notes:		
Note9: If output is connected to GND, please contact RECOM tech support for further information		

Specifications (measured @ Ta= 25°C, nom. Vin, full load and after warm-up unless otherwise stated)

DIMENSION and PHYSICAL CHARACTERISTICS

Parameter	Type	Value
Material	case/baseplate potting PCB	plastic, (UL94 V-0) silicone, (UL94 V-0) FR4, (UL94 V-0)
Dimension (LxWxH)		36.7 x 27.2 x 17.4mm
Weight		30g typ.

Dimension Drawing (mm)

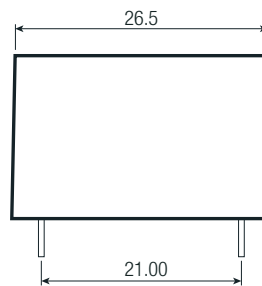
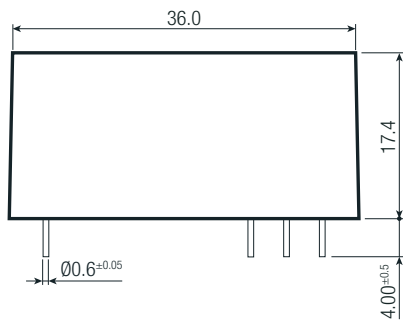
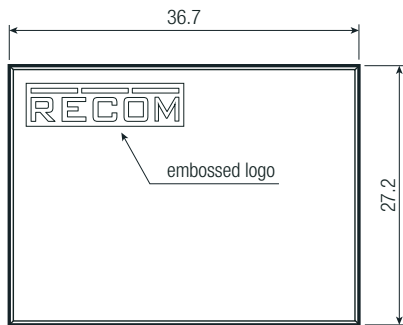
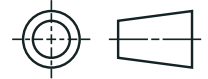

Pinning information

Pin #	Single
1	NC
2	VAC in (N)
3	VAC in (L)
4	NC
5	-Vout
6	+Vout

NC= no connection

Tolerance: xx.x= ±0.5mm
xx.xx= ±0.25mm

Recommended footprint details

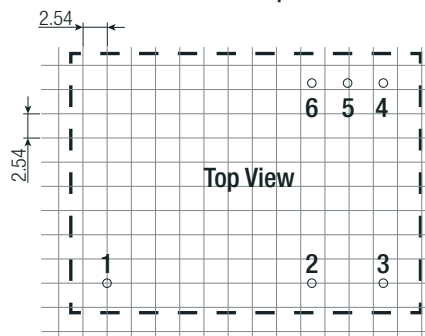
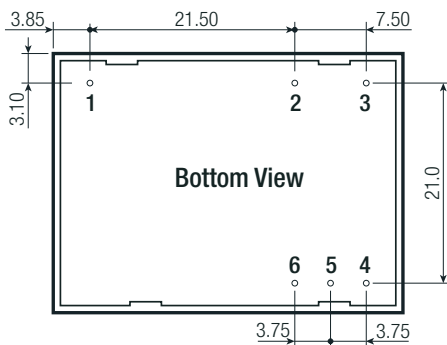

PACKAGING INFORMATION

Parameter	Type	Value
Packaging Dimension (LxWxH)	tube	506.4 x 29.8 x 25.5mm
Packaging Quantity		12pcs
Storage Temperature Range		-40°C to +85°C
Storage Humidity	non-condensing	20% to 90% RH max.

The product information and specifications may be subject to changes even without prior written notice. The product has been designed for various applications; its suitability lies in the responsibility of each customer. The products are not authorized for use in safety-critical applications without RECOM's explicit written consent. A safety-critical application is an application where a failure may reasonably be expected to endanger or cause loss of life, inflict bodily harm or damage property. The applicant shall indemnify and hold harmless RECOM, its affiliated companies and its representatives against any damage claims in connection with the unauthorized use of RECOM products in such safety-critical applications.

Mouser Electronics

Authorized Distributor

Click to View Pricing, Inventory, Delivery & Lifecycle Information:

[RECOM:](#)

[RAC04-15SK/277](#) [RAC04-05SK/277](#) [RAC04-12SK/277](#) [RAC04-24SK/277](#) [RAC04-3.3SK/277](#)