

Input Type

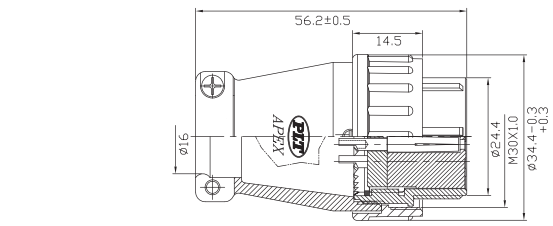

PLS-28 Series



PLS-28 -PF X-R

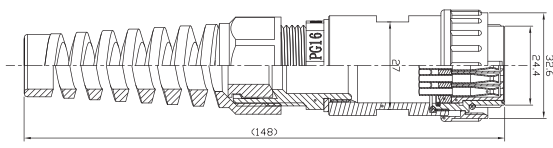

PLS-28 -PFD

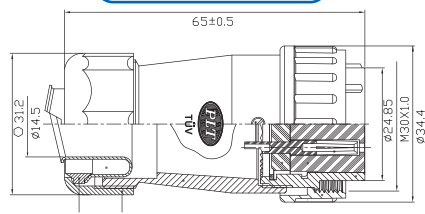

PLS-28 -GPF4 X-R 4=轉接1/2"軟管

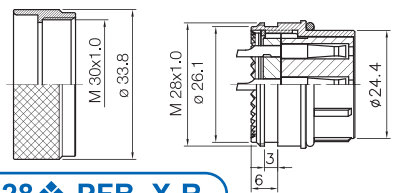

PLS-28 -PFB X-R



ACCESSORY:

PLS-28C-RCa-R

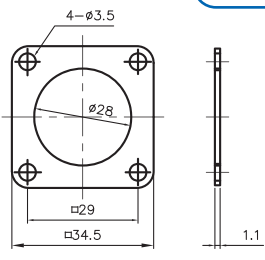

RUBBER PLATE FOR PLS-28 -RM

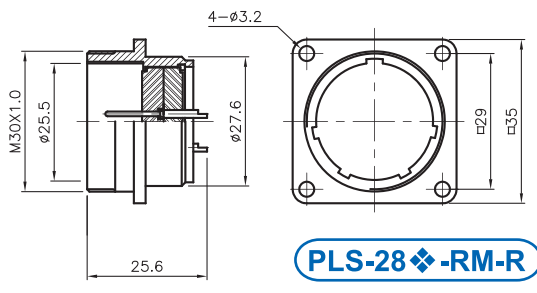
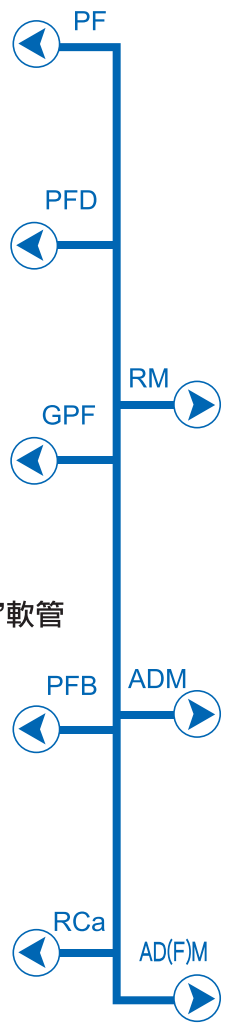
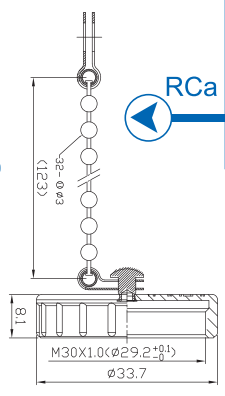

PLS-28 -RM-R

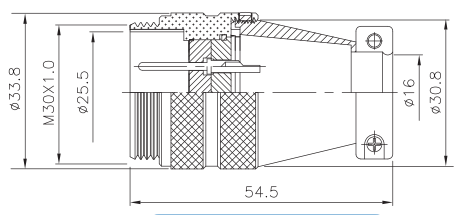

PLS-28 -ADM-R

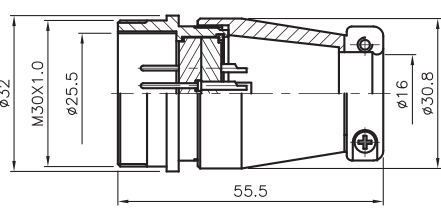

PLS-28 -AD(F)M-R

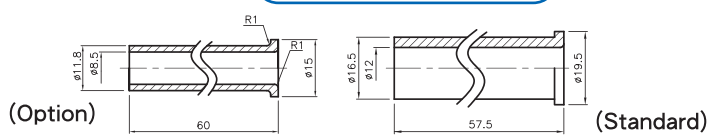

(Option)

(Standard)

RUBBER TUBE FOR PLS-28 -PF

◆ No. of contacts	3	4	7	12	16	17	20	26
Contacts Configuration								
	TÜV	TÜV	TÜV	TÜV	TÜV	TÜV	TÜV	TÜV
Rated current / voltage	15A 250V	15A 250V	15A 250V	10A 250V	10A 250V	10A 250V	5A 250V	5A 250V
Operation limit voltage (AC.V.rms)	400	400	400	250	250	250	250	250
Withstanding voltage (AC.V.rms) 1 minute	2000	2000	1800	1000	1000	1000	1000	1000
Insulation resistance (MΩ MIN.) at DC 500V	2000	2000	2000	1000	1000	1000	1000	1000
Contact resistance (mΩ MAX.) at DC 1A	3	3	3	5	5	5	3	3
Solder inter diameter	3.4	3.4	2.4	1.6	1.6	1.6	1.2	1.2

## Output Type

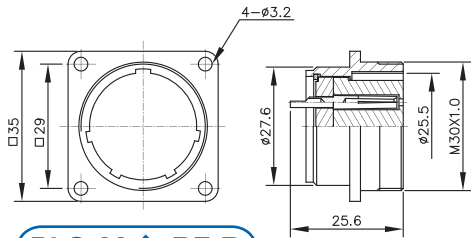

PLS-28-RF-R

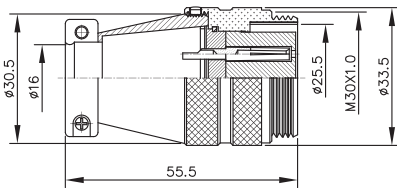

PLS-28-ADF-R

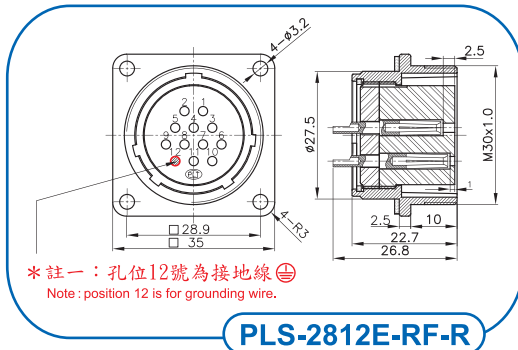

PLS-2812E-RF-R

### ACCESSORY:

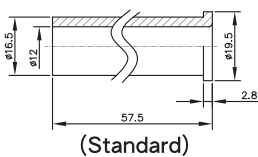
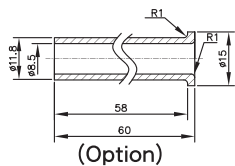

RUBBER PLATE FOR PLS-28-RF

RUBBER TUBE FOR PLS-28-PM

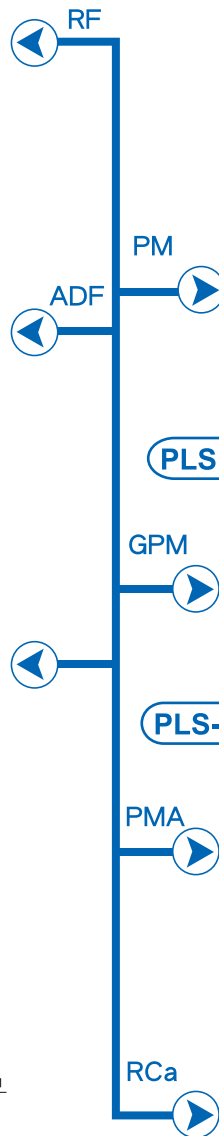

PLS-28 Series

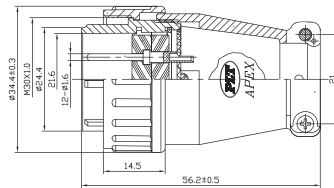

PLS-28-PM X-R

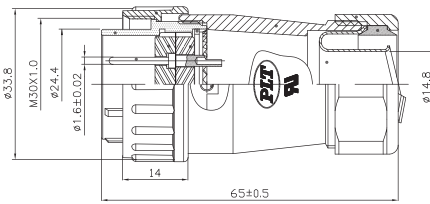

PLS-28-GPM4 X-R 4=轉接1/2"軟管

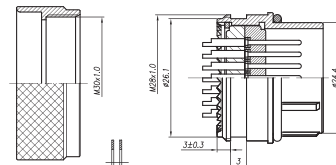

PLS-28-PMA XB-R



PLS-28C-RCa-R

◆ No. of contacts	3	4	7	12	16	17	20	26
Contacts Configuration								
Rated current / voltage	15A 250V	15A 250V	15A 250V	10A 250V	10A 250V	10A 250V	5A 250V	5A 250V
Operation limit voltage (AC.V.rms)	400	400	400	250	250	250	250	250
Withstanding voltage (AC.V.rms) 1 minute	2000	2000	1800	1000	1000	1000	1000	1000
Insulation resistance (MΩ MIN.) at DC 500V	2000	2000	2000	1000	1000	1000	1000	1000
Contact resistance (mΩ MAX.) at DC 1A	3	3	3	5	5	5	3	3
Solder inter diameter	3.4	3.4	2.4	1.6	1.6	1.6	1.2	1.2