

Mounting hardware and accessories



Mounting considerations

Surface

Wilcoxon's rugged sensors are designed to operate continuously in harsh industrial environments. Consideration of mounting surface and wiring requirements will ensure optimal performance of the sensor throughout the lifetime of the machinery being monitored. The accuracy of high frequency signals is dependent on how direct and rigid the contact is between the sensor and the machine. Adequately preparing the mounting surface provides the best performance and output of reliable data ensuring an accurate assessment of machine condition.

Tips:

- Mount sensors in a location that minimizes the vibration transmission route from the driving point source of vibration (shaft) through the machine to the sensor
- Avoid mounting the sensor on thin sections, guards or vibration-free areas (antinodes), or areas with extreme temperature variations
- Use a silicon grease to increase the performance of permanently mounted sensors

Frequency range

The mounting location of each sensor should be based on the characteristics of the machinery to be monitored. The dynamic measurement requirements of frequency and amplitude range should be evaluated against the frequency range of the desired type of measurement. Each mounting method has a different effect on an sensor's operating frequency range.

Accelerometers have a natural resonance 3 to 5 times higher than the data sheet specified upper-end frequency response. The goal of measurement is to utilize the flat portion of the frequency response (the portion between the upper and lower 3 dB limit) for the best characterization of vibration levels. To ensure optimal response, careful attention should be made to the contact surface area and the proximity to the actual source of the vibration.

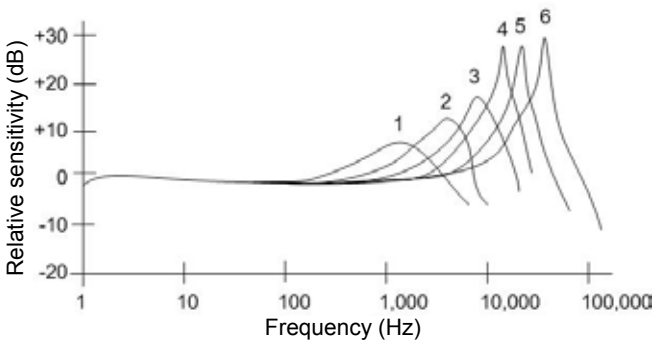

	1 Probe tip	2 Curved surface magnet	3 Flat magnet	4 Adhesive	5 Cementing mounting pad	6 Stud
Frequency range	500 -1,000 Hz	2,000 - 5,000 Hz	10,000 Hz	10,000-15,000 Hz	30,000-45,000 Hz	Max sensor response
	Acceptable		Good		Best	

Mounting options

Permanent mounting: stud, cementing pad

Stud mounting offers the widest and most accurate frequency dynamic measurement range and is highly recommended for permanent monitoring systems, high frequency testing such as gearbox monitoring and harsh environments.

Cementing pads approach the high frequency capabilities of stud mounts when used properly, without the need of drilling into the structure. They are often used in applications where multiple locations will be measured using a single sensor. Mounting pads can also be used when multiple sensors are mounted for short periods of time, and directly epoxying the sensor is not practical.

Adhesive mounting

If the machine cannot be drilled or surface quality is poor, adhesives provide a secure attachment and are the next best alternative to epoxied mounting. The sensor's operational frequency range will be reduced because the adhesive acts as a shock absorber, introducing a lower resonance than stud mounting. Replacement or removal of adhesive mounted sensors is the most difficult compared to any other mounting method.

Temporary mounting: magnets and probe tips

Magnets and probe tips used with sensors and data collectors are best when be used for walkaround monitoring programs. The frequency range of both methods is dramatically reduced compared to stud or adhesive mounts, but is still adequate for general purpose machine monitoring. Care must be used when interpreting data to account for resonance from mounting.







Permanent mounting solutions

Mounting pads and studs

Stud mounting is the most reliable mounting option because it can achieve the sensor's maximum frequency range. Sensors are installed by using a double ended stud. One end is inserted into a threaded hole in the base of the sensor and the other end is inserted into a properly prepared threaded hole in the machinery. Wilcoxon offers the ST101 spot face tool for fast and easy surface preparation.

Tips:

- Torque to specification to avoid inaccurate frequency response, poor coupling and/or sensor damage
- Avoid small debris between sensor and surface, this can dramatically reduce the upper frequency response limit
- A thin coating of silicone grease can increase mounting stiffness and enhance frequency response

						
	SF1 short mounting stud	SF2 mounting stud	SF3 mounting adapter stud	SF3M mounting adapter stud	SF4 mounting stud with base	SF4M mounting adapter stud
Size	0.26 in	0.62 in	0.315 in	0.315 in	0.625 in hex	0.32 in
Mount	10-32 UNF both ends	10-32 UNF both ends	10-32 to 1/4-28 threaded hole	10-32 to M8-1.25 threaded hole	10-32 UNF both ends	10-32 to M6 threaded hole
Mounting torque	30 in-lb	30 in-lb	20 in-lb	20 in-lb	18 in-lb	30 in-lb
Description	Stainless steel	Stainless steel	Stainless steel	Stainless steel	Isolated, stainless steel with non-conductive layer of epoxy to prevent ground loops	Isolated, stainless steel with non-conductive layer of epoxy to prevent ground loops

						
	SF5 epoxy mounting stud	SF6 mounting stud	SF6M mounting stud	SF6M-1 mounting stud	SF7 mounting stud	SF7B adapter stud
Size	0.5 in hex	0.375 in	0.53 in	0.39 in	0.83 in	0.33 in
Mount	10-32 thread	1/4-28 both ends	1/4-28 to M8	1/4-28 to M6	3/8-16 thread both ends	1/4-28 internal to 3/8-16 external
Mounting torque	18 in-lb	24 in-lb	24 in-lb	24 in-lb	30 in-lb	24 in-lb
Description	Anodized aluminum	Stainless steel	Anodized aluminum	Anodized aluminum	Stainless steel, recommended for ring mode accelerometers	Threaded (helical) inserts

All Wilcoxon mounting accessories are backed by lifetime warranty.

Permanent mounting solutions

Cementing pads

Cementing pads should be used when the structure to be monitored cannot to be drilled. When installed properly, they provide high frequency capability approaching stud mounts. Some epoxies, such as VERSIL406, offer electrical isolation from the ground when properly applied.

Tips:

- Avoid rubbery or sticky adhesives
- Adhesive layer should be as thin and rigid as possible



	Cementing pads			
	SF8	SF8-2	SF8-8	SF8M-9
Size	1.0 in	1.0 in	1.0 in	1.0 in
Mount	1/4-28 integral stud	1/4-28 tapped hole	10-32 hole	M6 hole
Mounting torque	24 in-lb	24 in-lb	24 in-lb	24 in-lb
Description	Stainless steel	Keyed	Keyed, use with 993B sensor	Stainless steel



	SF11 magnetic pad	SF20-1 stud	SF20-2 stud	SF20-3 cementing pad	SF20-M4 captive screw	SF20-M8 stud
Size	1.0 in	0.55 in	0.75 in	1.0 in	0.85 in	0.72 in
Mount	-	1/4-28 to 3/8-24	3/8-24	3/8-24 integral stud	M4	3/8-24 to M8
Mounting torque	-	24 in-lb	50 in-lb	50 in-lb	24 in-lb	24 in-lb
Description	Stainless steel	Stainless steel	Stainless steel	Stainless steel	For 712F and 997 sensors	Black oxide coating

Isolator mounting bases

Wilcoxon's SF series electrically isolate the sensor from the case of the machine, providing protection from up to 1,500 volts of electricity. The isolators are corrosion resistant and can withstand temperatures up to 180° C. The sensor is protected against high voltage, static electricity build-up, ESD shocks and grounding issues such as poor ground bonding, ground loops or different ground potential.

Tips:

- Ensure all contaminants are removed from isolation material to avoid conduction
- Adhesive layer should be as thin and rigid as possible.



	SF21	SF22	SF23	SF24
Length across flats	1.0 in	1.0 in	1.125 in	1.125 in
Diameter	0.82 in	0.82 in	0.94 in	0.94 in
Mount	1/4-28 to 1/4-28	1/4-28 to M8-1.25	1/4-28 to 1/4-28	1/4-28 to M8-1.25
Mounting torque	24 in-lb	24 in-lb	24 in-lb	24 in-lb

Temporary mounting solutions

Magnetic mounting bases

Magnetic bases are a quick and convenient option for walkaround applications, and are often used on large machinery. They can be quickly attached and removed on both flat and curved surfaces. All Wilcoxon magnets are designed with corrosion resistant stainless steel casings for use in harsh environments.

Magnetic bases produce a significantly different response at higher frequencies compared to stud and cementing pad measurements. The most significant disadvantage is the lower resonant frequency of the coupled system. Due to the higher mass, caution must be exercised when viewing data higher than 1,000 Hz. The added mass may affect the measurement of very light structures due to mass loading.

Tips:

- Coupling fluids, such as oil greatly improve measurements with flat bottom magnets and should be used whenever possible
- For accurate trending, mark measurement locations to ensure readings are taken at the same place every time



	Magnets for flat surfaces					
	B1A (isolated)	B2A	MF015	MF040	MF075	MF120
Pull strength	40 lbf	40 lbf	15 lbf	50 lbf	75 lbf	120 lbf
Diameter	0.95 in	0.95 in	0.75 in	1.00 in	1.25 in	1.50 in
Height	0.69 in	0.56 in	0.41 in	0.50 in	0.50 in	0.60 in
Thread	10-32 stud	10-32	10-32	1/4-28	1/4-28	1/4-28



	2 pole magnets for curved surfaces				
	B11	MD020	MD035	MD055	MD130
Pull strength	20 lbf	20 lbf	35 lbf	55 lbf	130 lbf
Diameter	0.81 in	0.75 in	1.00 in	1.25 in	2.00 in
Height	0.56 in	0.76 in	0.78 in	0.76 in	1.10 in
Thread	8-32	1/4-28	1/4-28	1/4-28	1/4-28



	Magnets for triaxial sensors	
	MT075	MT075A
Pull strength	75 lbf	75 lbf
Diameter	1.50 in	1.50 in
Height	0.75 in	0.75 in
Thread	1/4-28	10-32

Specialty mounting

Fin mounts

The FM series is designed to be epoxied or welded between cooling fins of large electric motors. Fin mounts are typically used on non-drive locations where cooling fan shrouds prevent monitoring on the end belt.



	FM101	FM102	FM103	FM104
Diameter	0.50 in	0.50 in	0.25 in	0.25 in
Height	1.25 in	2.00 in	1.75 in	1.00 in

Quicklink mounting

QuickLINK mounting pads reduce collection time during walkaround monitoring applications. They offer the speed of magnetic mounting and the measurement reliability of permanent installations.



	QB-1 sensor adaptor	QP-1 mounting pad	QP-2 cementing pad
Diameter	1.0 in	1.0 in	1.0 in
Mount	1/4-28	1/4-28 tapped hole base	flat base
Mounting torque	24 in-lb	24 in-lb	-

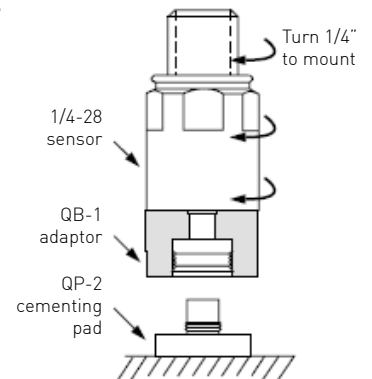

Triaxial mounting cubes

Three accelerometers can be mounted to the TC series cubes to measure vibration along three orthogonal directions (x,y,z). The cubed design allows free alignment of the x and y axes.



	TC1	TC1B	TC2
Size	1.0 in	1.0 in	2.6 in
Weight	1.27 oz	1.27 oz	17.64 oz
Mount	10-32	1/4-28	3/8-16
Description	Anodized aluminum, non-conductive coating prevents ground loops	Anodized aluminum, non-conductive coating prevents ground loops	Anodized aluminum, non-conductive coating prevents ground loops. Use with 731A sensor

Additional accessories

Mounting grease



The acid and alkaline resistant SILGREASE can be used to assist in temporary walkaround mounting applications. The non-toxic grease is USDA approved for use in the food and beverage industry. It offers radiation resistance and is electrically insulating, even in moist environments.



Spot face tool

The ST101 includes an integral pilot drill for creating 1/4-28 tapped holes. It can be used in either portable or bench mounted drills to produce a high grade flat surface suitable for stud mounting accelerometers with M8 threads.



Mounting epoxy

Adhesive or glue mounting provides a secure attachment without extensive machining but can reduce the operational frequency range since the adhesive acts like a shock absorber, known as damping. VERSIL406 epoxy can be used for flat surface mounting applications in areas up to 150° C. One packet provides sufficient adhesive for mounting 5-7 bases.



Probetip

The PT2 can be used to take readings of hard to reach areas or surfaces that are not conducive to mounting. It easily connects to any vibration meter via 1/4-28 mounting hole.





Wilcoxon Sensing Technologies
20511 Seneca Meadows Parkway
Germantown, MD 20876
USA

Tel: (301) 330 8811
Fax: (301) 330 8873
info@wilcoxon.com
www.wilcoxon.com

Mouser Electronics

Authorized Distributor

Click to View Pricing, Inventory, Delivery & Lifecycle Information:

[Amphenol:](#)

[MD130](#) [B1A](#) [MD020](#) [MD035](#) [MF040](#) [FM102](#) [MF075](#) [SF22](#) [SF24](#) [SF4M](#) [SF8-2](#) [TC1B](#) [FM101](#) [FM103](#) [MF120](#)
[MT075](#) [MT075A](#) [SF23](#) [SF8-8](#) [TC1](#) [PT2](#) [SF3M](#) [SF4](#) [SF25](#) [ST101](#) [QB-1](#) [QP-1](#) [SF20-3](#) [SF20-M8](#) [SF6M-3](#) [SF7](#)
[SF1](#) [SF2](#) [SF6](#) [SF8M-4](#) [VERSIL406](#) [FM104](#) [SF20-2](#) [SF6M-1](#) [SF7B](#) [SF3](#) [SF8M-9](#) [SILGREASE](#) [B11](#) [MD055](#)
[SF11](#) [SF5](#) [SF8](#) [B2A](#) [MF015](#) [QP-2](#) [SF21](#) [SF6M](#) [TC2](#) [SF20-1](#) [SF20-M4](#)