



# MIC94060/61/62/63

## High Side Power Switches

### General Description

The MIC94060-63 are high-side load switches designed for operation between 1.7V to 5.5V. The devices contain a low on-resistance P-channel MOSFET that supports over 2A of continuous current. The MIC94061 and MIC94063 features an active load discharge circuit which insures capacitive loads retain no charge when the main switch is in an OFF state.

MIC94060-61 feature rapid turn on while MIC94062-63 provide a slew rate controlled Soft-Start turn-on of 800 $\mu$ s (typical) to prevent in-rush current from glitching supply rails.

An active pull-down on the enable input keeps MIC94060-63 in a default OFF state until the EN pin is pulled to a high level. Built-in level shift circuitry allows low voltage logic signals to switch higher supply voltages, or vice versa; high level logic signals can control low level voltages.

MIC94060-63's operating voltage range makes them suitable for 1-cell Lithium ion and 2- to 3-cell NiMH/NiCad/Alkaline powered systems, as well as, all 5V applications. Their low operating current of 2 $\mu$ A and low shutdown current of <1 $\mu$ A maximize battery life.

Data sheets and support documentation can be found on Micrel's web site at: [www.micrel.com](http://www.micrel.com).

### Features

- 1.7V to 5.5V input voltage range
- 2A continuous operating current
- 77m $\Omega$  (typ)  $R_{DS(ON)}$
- Built-in level shift for control logic; can be operated by 1.5V logic.
- Low 2 $\mu$ A quiescent current
- Soft-Start: MIC94062-63
- Micro-power shutdown <1 $\mu$ A
- Load discharge circuit: MIC94061, MIC94063
- Space saving 1.2mm x 1.6mm Thin MLF<sup>®</sup> package

### Applications

- Load switch in portable applications:
  - Cellular phones
  - PDAs
  - MP3 players
  - Digital Cameras
  - Portable instrumentation
- Battery switch-over circuits
- Level translator

### Typical Application

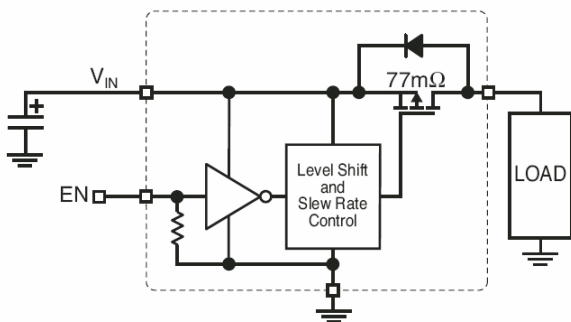

**MIC94060, 62**  
Load Switch Application

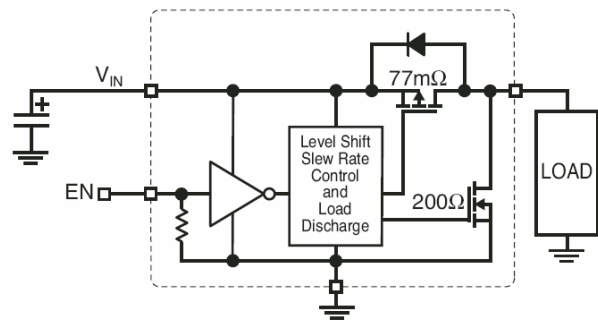

**MIC94061, 63**  
Load Switch with Capacitive Load Discharge

## Ordering Information

Part Number		Part Marking <sup>(1)</sup>		Soft-Start	Load Discharge	Package
Standard	Pb-Free	Standard	Pb-Free			
MIC94060BC6	MIC94060YC6	P54	<u>P</u> 54			SC-70-6
MIC94061BC6	MIC94061YC6	P55	<u>P</u> 55		•	
MIC94062BC6	MIC94062YC6	P56	<u>P</u> 56	•		
MIC94063BC6	MIC94063YC6	P57	<u>P</u> 57	•	•	
—	MIC94060YMT	—	P54			1.2mm x 1.6mm Thin MLF <sup>®</sup> (2,3)
—	MIC94061YMT	—	P55		•	
—	MIC94062YMT	—	P56	•		
—	MIC94063YMT	—	P57	•	•	

### Notes

- Underbar symbol on SC-70 Pb-free packages may not be to scale.
- MLF<sup>®</sup> ▲ = Pin 1 identifier.
- MLF<sup>®</sup> is a GREEN RoHS compliant package. Lead finish is NiPdAu. Mold compound is Halogen Free.

## Pin Configuration

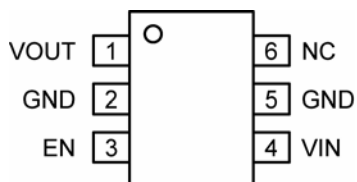

SC-70-6 (C6)

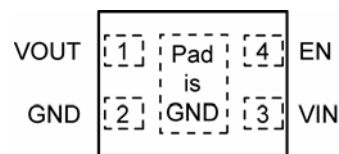

Top View

1.2x1.6 mm Thin MLF<sup>®</sup> (MT)

## Pin Description

Pin Number		Pin Name	Pin Function
SC-70	MLF		
1	1	V <sub>OUT</sub>	Drain of P-channel MOSFET.
2,5	2	GND	Ground and the backside pad (MLF only) should both be connected to electrical ground.
4	3	V <sub>IN</sub>	Source of P-channel MOSFET.
3	4	EN	Enable (Input): Active-high CMOS compatible control input for switch A. Do not leave floating.
6	--	NIC	No Internal Connection. A signal or voltage applied to this pin will have no effect on device operation.

**Absolute Maximum Ratings <sup>(1)</sup>**

Input Voltage ( $V_{IN}$ )	+6V
Enable Voltage ( $V_{EN}$ )	+6V
Continuous Drain Current ( $I_D$ ) <sup>(3)</sup>	
$T_A = 25^\circ\text{C}$	$\pm 2\text{A}$
$T_A = 85^\circ\text{C}$	$\pm 1.4\text{A}$
Pulsed Drain Current ( $I_{DP}$ ) <sup>(4)</sup>	$\pm 6\text{A}$
Continuous Diode Current ( $I_S$ ) <sup>(4)</sup>	-50mA
Storage Temperature ( $T_S$ )	-55°C to +150°C
ESD Rating – HBM <sup>(6)</sup>	4KV

**Operating Ratings <sup>(2)</sup>**

Input Voltage ( $V_{IN}$ )	+1.7 to +5.5V
Junction Temperature ( $T_A$ )	-40°C to +125°C
Package Thermal Resistance	
SC-70-6 ( $\theta_{JA}$ )	240°C/W
1.2x1.6 MLF ( $\theta_{JA}$ )	172°C/W
1.2x1.6 MLF ( $\theta_{JC}$ ) <sup>(3)</sup>	134°C/W

**Electrical Characteristics**

$V_{IN} = 5\text{V}$ ;  $T_A = 25^\circ\text{C}$ , bold values indicate  $-40^\circ\text{C} \leq T_A \leq +85^\circ\text{C}$ , unless noted.

Symbol	Parameter	Condition	Min	Typ	Max	Units
$V_{EN\_TH}$	Enable Threshold Voltage	$V_{IN} = 1.8\text{V to } 4.5\text{V}, I_D = -250\mu\text{A}$	0.5		1.2	V
		$V_{IN} = 1.7\text{V to } 4.5\text{V}, I_D = -250\mu\text{A}$	0.4		1.2	V
$I_{EN}$	Enable Input Current	$V_{IN} = V_{EN} = 5.5\text{V}$		2	4	$\mu\text{A}$
$I_{VIN}$	OFF State Leakage Current	$V_{IN} = +5.5\text{V}, V_{EN} = 0\text{V}$			1	$\mu\text{A}$
$R_{DS(ON)}$	P-Channel Drain to Source ON Resistance  SC-70 Package	$V_{IN} = +4.5\text{V}, I_D = -100\text{mA}, V_{EN} = 1.5\text{V}$		77	110	m $\Omega$
		$V_{IN} = +3.6\text{V}, I_D = -100\text{mA}, V_{EN} = 1.5\text{V}$		85	115	m $\Omega$
		$V_{IN} = +2.5\text{V}, I_D = -100\text{mA}, V_{EN} = 1.5\text{V}$		100	140	m $\Omega$
		$V_{IN} = +1.8\text{V}, I_D = -100\text{mA}, V_{EN} = 1.5\text{V}$		145	200	m $\Omega$
		$V_{IN} = +1.7\text{V}, I_D = -100\text{mA}, V_{EN} = 1.5\text{V}$		155	215	m $\Omega$
$R_{DS(ON)}$	P-Channel Drain to Source ON Resistance  MLF Package	$V_{IN} = +4.5\text{V}, I_D = -100\text{mA}, V_{EN} = 1.5\text{V}$		85	115	m $\Omega$
		$V_{IN} = +3.6\text{V}, I_D = -100\text{mA}, V_{EN} = 1.5\text{V}$		100	140	m $\Omega$
		$V_{IN} = +2.5\text{V}, I_D = -100\text{mA}, V_{EN} = 1.5\text{V}$		145	200	m $\Omega$
		$V_{IN} = +1.8\text{V}, I_D = -100\text{mA}, V_{EN} = 1.5\text{V}$		155	215	m $\Omega$
		$V_{IN} = +1.7\text{V}, I_D = -100\text{mA}, V_{EN} = 1.5\text{V}$		165	225	m $\Omega$
$R_{SHUTDOWN}$	Turn-Off Resistance	$V_{IN} = +3.6\text{V}, I_{TEST} = 1\text{mA}, V_{EN} = 0\text{V}$ MIC94061, 63		200	300	$\Omega$

**Dynamic**

Symbol	Parameter	Condition	Min	Typ	Max	Units
$t_{ON\_DLY}$	Turn-On Delay Time	$V_{IN} = +3.6\text{V}, I_D = -100\text{mA}, V_{EN} = 1.5\text{V}$ MIC94060, 61		0.85	1.5	$\mu\text{s}$
		$V_{IN} = +3.6\text{V}, I_D = -100\text{mA}, V_{EN} = 1.5\text{V}$ MIC94062, 63		700	1200	$\mu\text{s}$
$t_{ON\_RISE}$	Turn-On Rise Time	$V_{IN} = +3.6\text{V}, I_D = -100\text{mA}, V_{EN} = 1.5\text{V}$ MIC94060, 61	0.5	1	5	$\mu\text{s}$
		$V_{IN} = +3.6\text{V}, I_D = -100\text{mA}, V_{EN} = 1.5\text{V}$ MIC94062, 63	500	800	1500	$\mu\text{s}$

**Dynamic (Continued)**

t <sub>OFF_DLY</sub>	Turn-Off Delay Time	V <sub>IN</sub> = +3.6V, I <sub>D</sub> = -100mA, V <sub>EN</sub> = 1.5V MIC94060, 61	100	200	ns
		V <sub>IN</sub> = +3.6V, I <sub>D</sub> = -100mA, V <sub>EN</sub> = 1.5V MIC94062, 63	60	200	ns
t <sub>OFF_FALL</sub>	Turn-Off Fall Time	V <sub>IN</sub> = +3.6V, I <sub>D</sub> = -100mA, V <sub>EN</sub> = 1.5V MIC94060, 61	60	100	ns
		V <sub>IN</sub> = +3.6V, I <sub>D</sub> = -100mA, V <sub>EN</sub> = 1.5V MIC94062, 63	60	100	ns

**Notes:**

1. Exceeding the absolute maximum rating may damage the device.
2. The device is not guaranteed to function outside its operating rating.
3. With backside thermal contact to PCB.
4. Pulse width <300μs with < 2% duty cycle.
5. Continuous body diode current conduction (reverse conduction, i.e. V<sub>OUT</sub> to V<sub>IN</sub>) is not recommended.
6. Devices are ESD sensitive. Handling precautions recommended. HBM (Human body model), 1.5kΩ in series with 100pF.

# Typical Characteristics

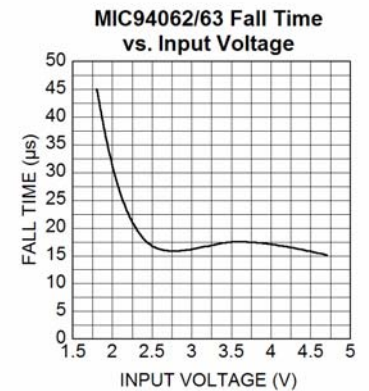
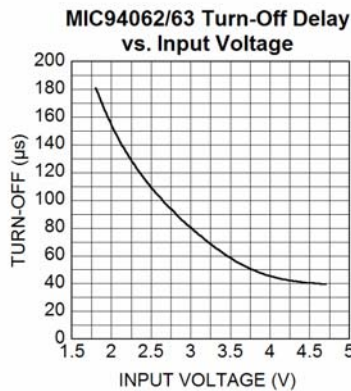
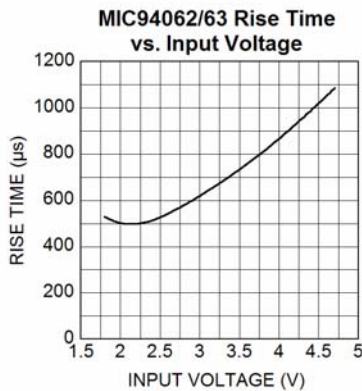
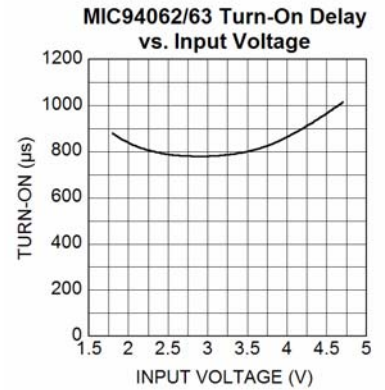
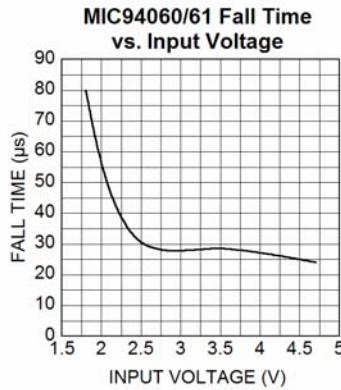
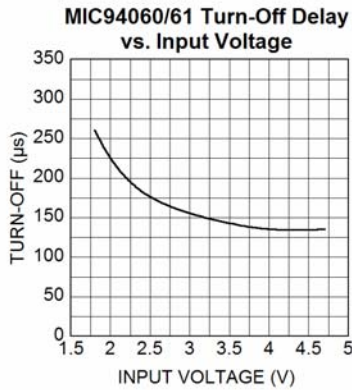
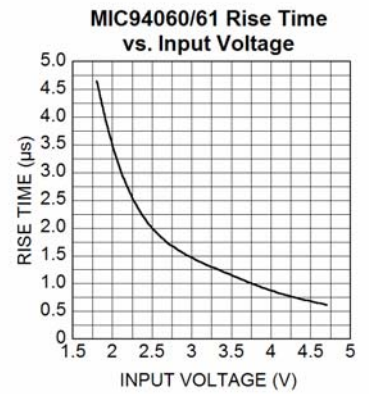
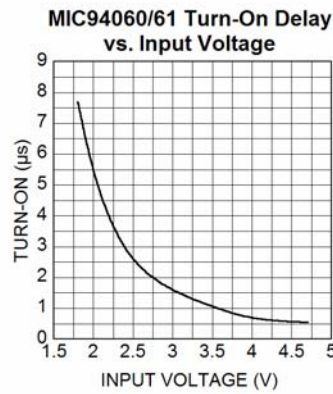
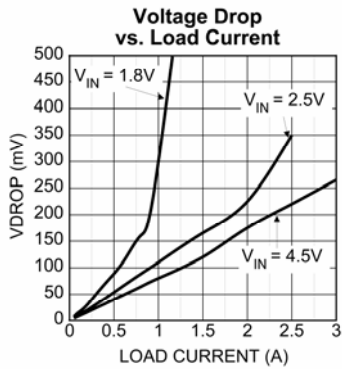
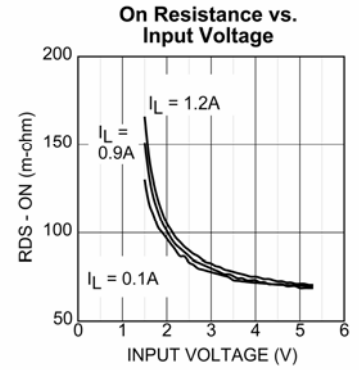
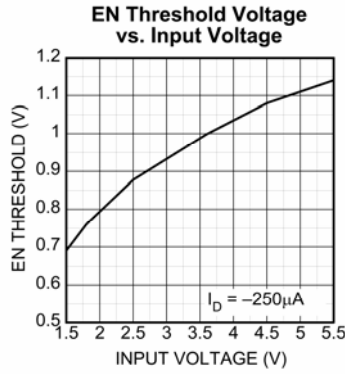
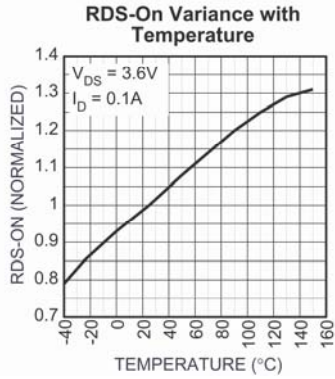

# Functional Characteristics

## MIC94060

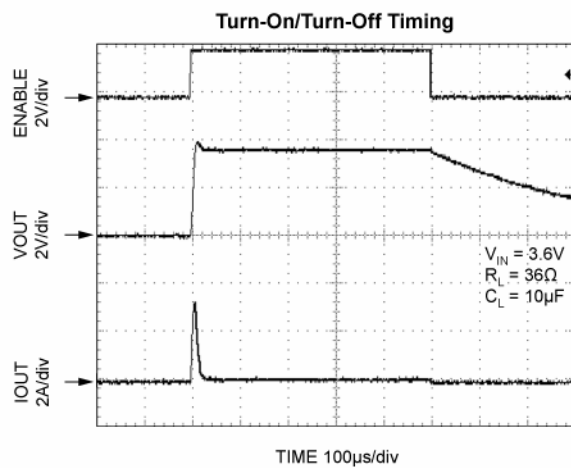
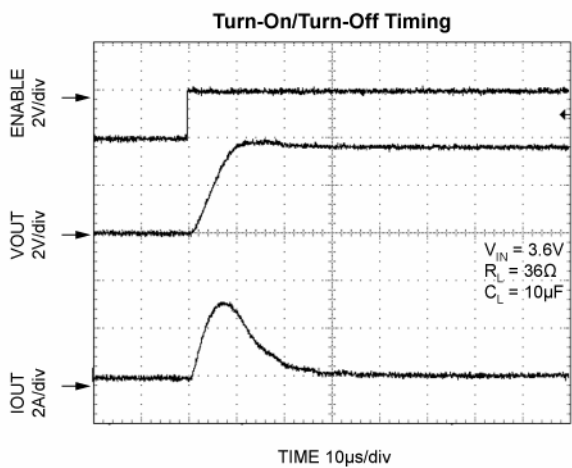
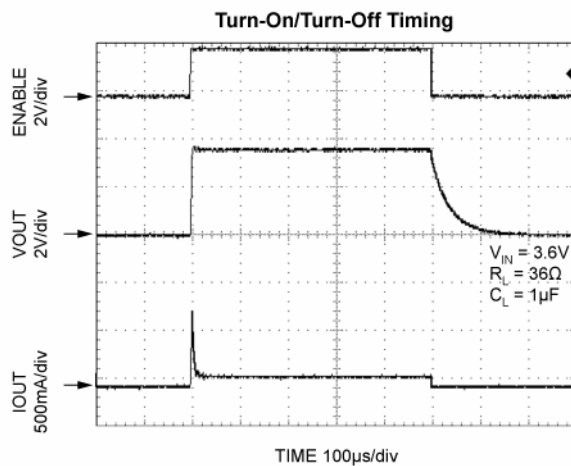
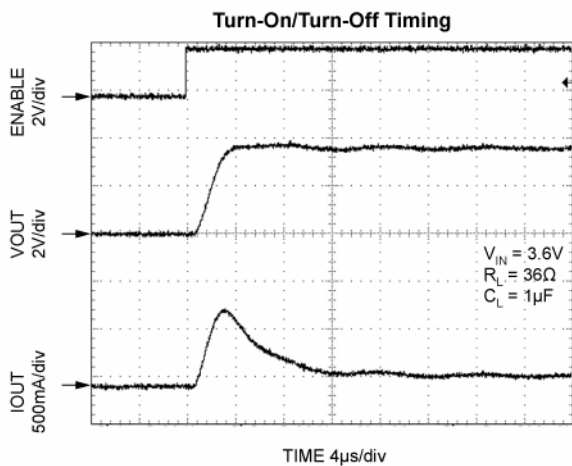

# MIC94061

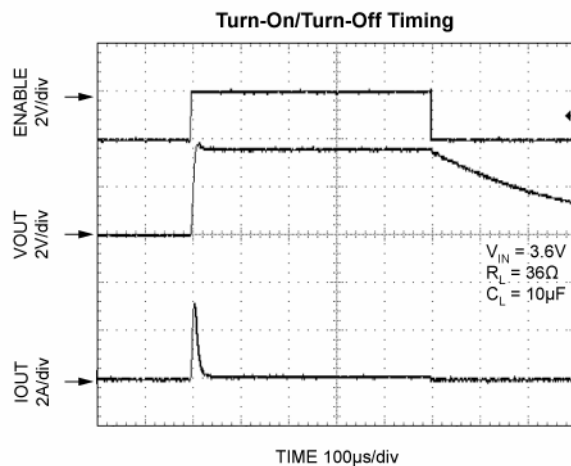
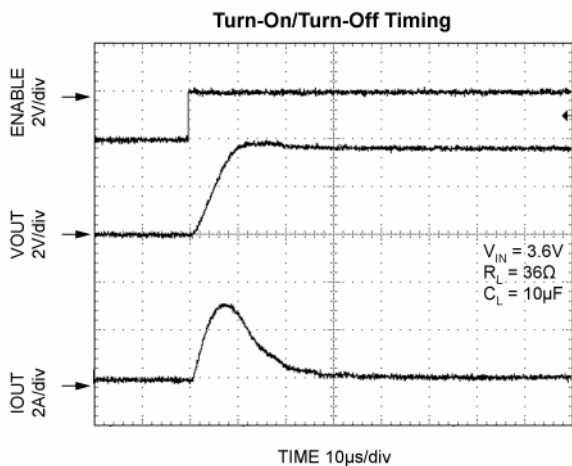
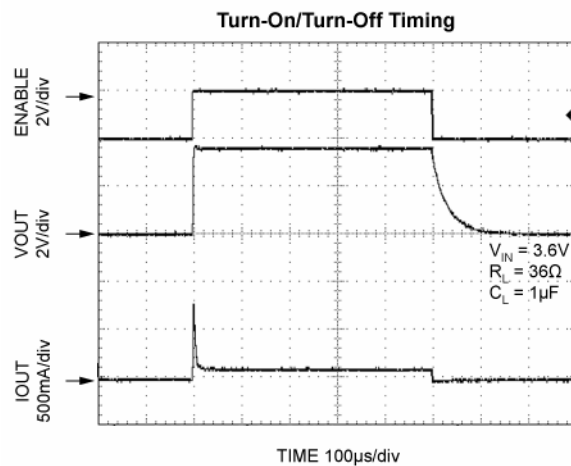
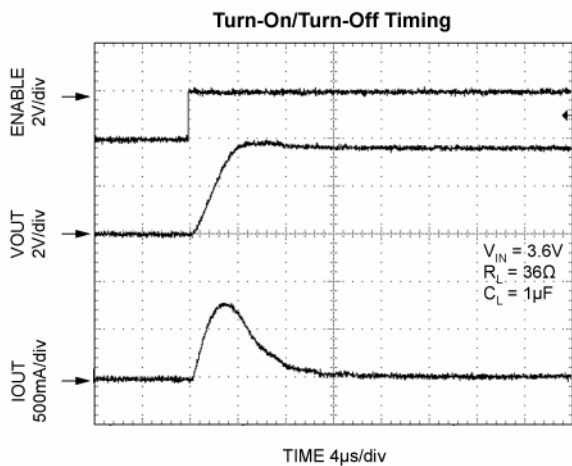

MIC94062

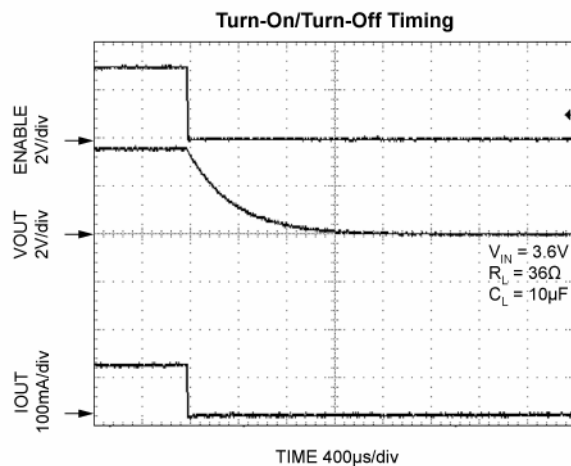
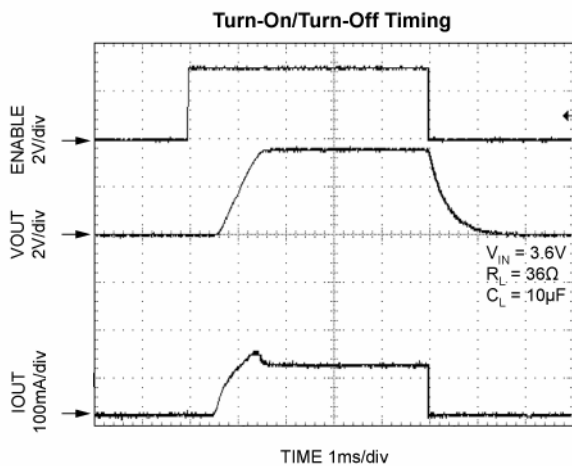
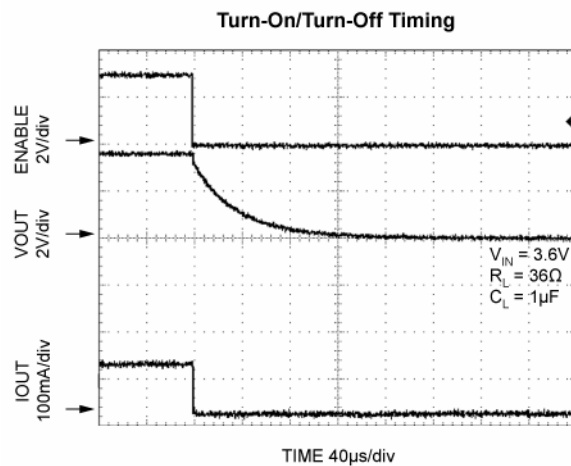
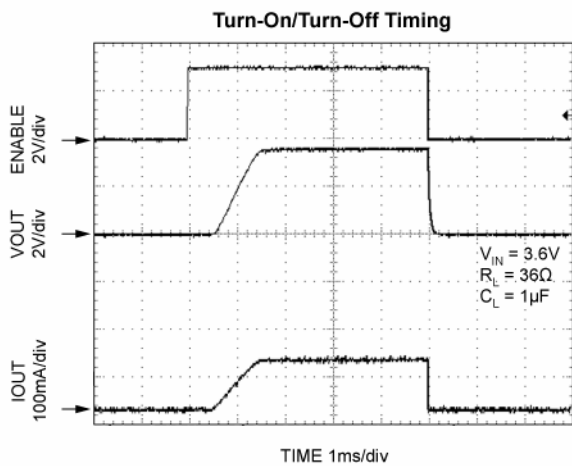



MIC94063

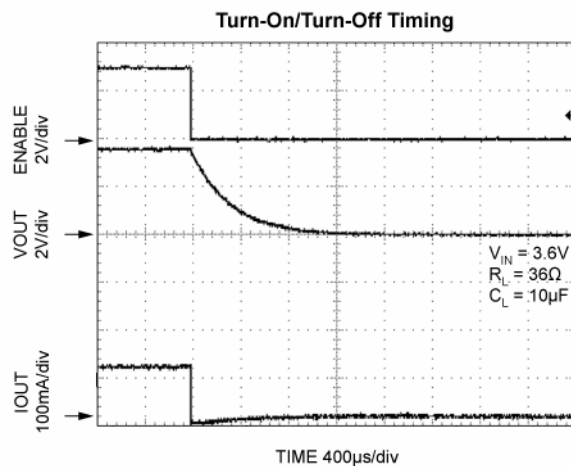
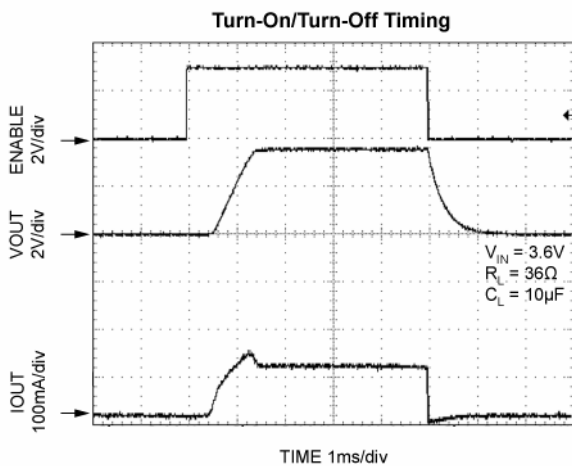
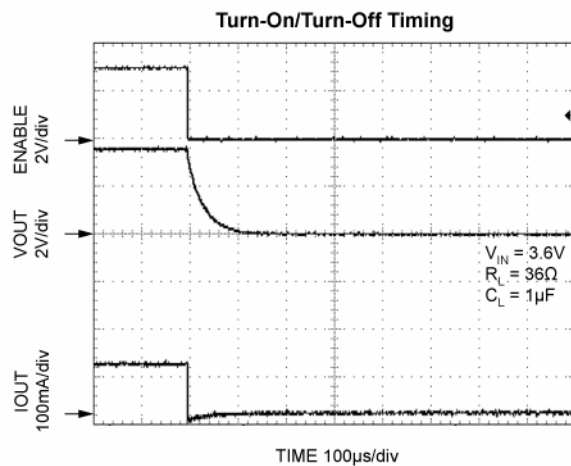
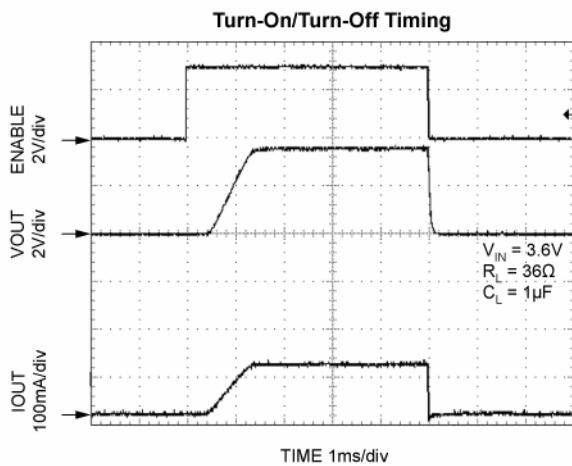

### Package Information

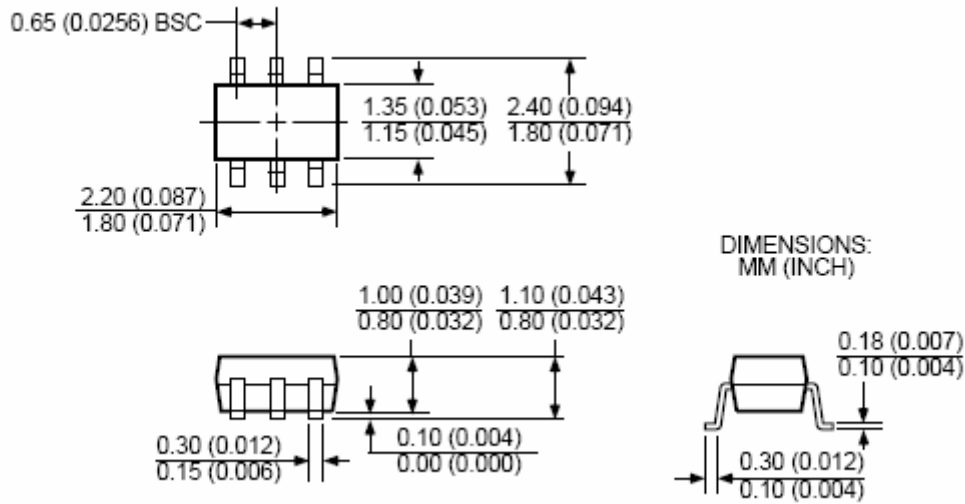

6-Pin SC-70 (C6)

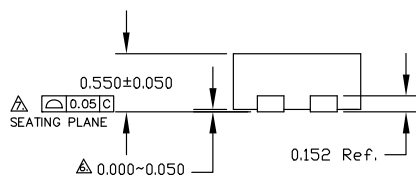
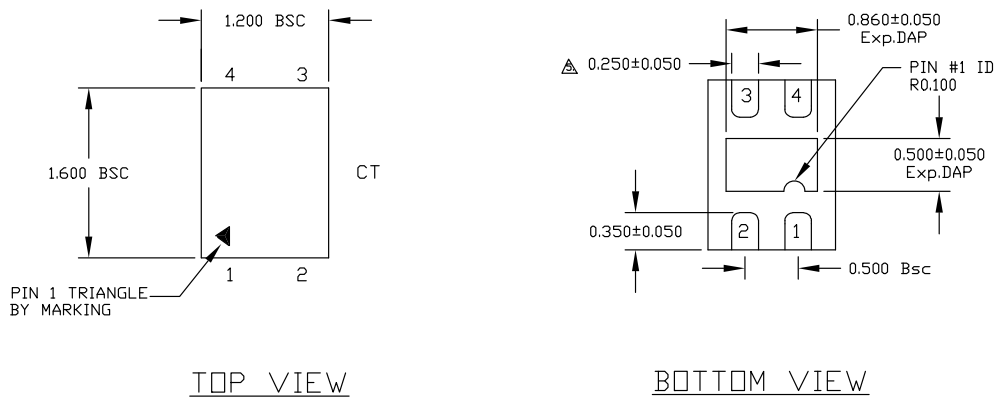

- NOTE:
1. ALL DIMENSIONS ARE IN MILLIMETERS.
  2. MAX. PACKAGE WARPAGE IS 0.05 mm.
  3. MAXIMUM ALLOWABLE BURRS IS 0.076 mm IN ALL DIRECTIONS.
  4. PIN #1 ID ON TOP WILL BE LASER/INK MARKED.
- △ DIMENSION APPLIES TO METALIZED TERMINAL AND IS MEASURED BETWEEN 0.20 AND 0.25 mm FROM TERMINAL TIP.
- △ APPLIED ONLY FOR TERMINALS.
- △ APPLIED FOR EXPOSED PAD AND TERMINALS.

4-Pin Thin MLF<sup>®</sup> (MT)

## Recommended Land Pattern for MLF 1.2x1.6 4 Lead

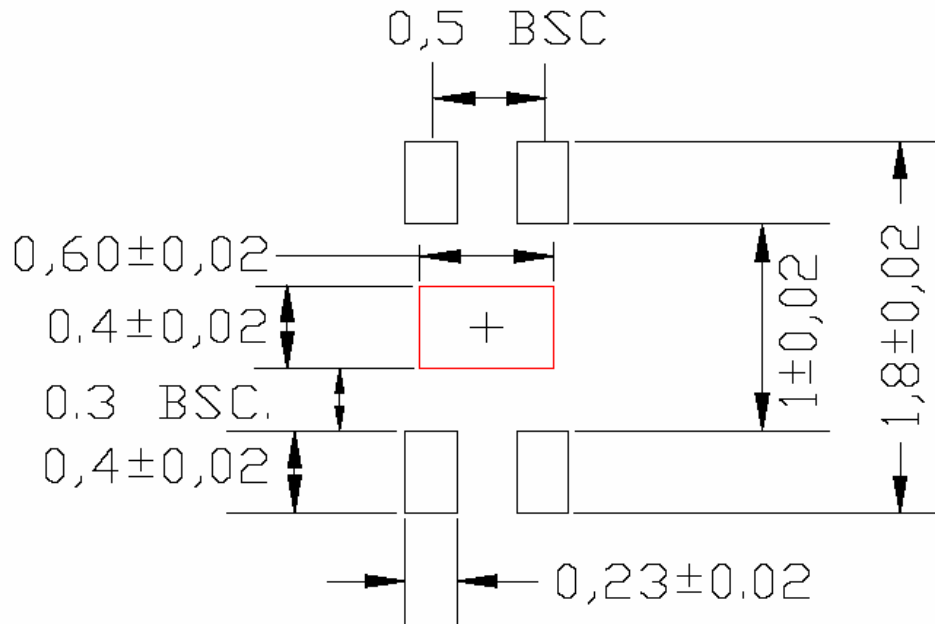

Optional for maximum thermal performance. Heatsink should be connected to GND plane of PCB for maximum thermal performance.

Disclaimer: This is only a recommendation based on information available to Micrel from its suppliers. Actual land pattern may have to be significantly different due to various materials and processes used in PCB assembly. Micrel makes no representation or warranty of performance based on the recommended land pattern."

**MICREL, INC. 2180 FORTUNE DRIVE SAN JOSE, CA 95131 USA**  
 TEL +1 (408) 944-0800 FAX +1 (408) 474-1000 WEB <http://www.micrel.com>

The information furnished by Micrel in this data sheet is believed to be accurate and reliable. However, no responsibility is assumed by Micrel for its use. Micrel reserves the right to change circuitry and specifications at any time without notification to the customer.

Micrel Products are not designed or authorized for use as components in life support appliances, devices or systems where malfunction of a product can reasonably be expected to result in personal injury. Life support devices or systems are devices or systems that (a) are intended for surgical implant into the body or (b) support or sustain life, and whose failure to perform can be reasonably expected to result in a significant injury to the user. A Purchaser's use or sale of Micrel Products for use in life support appliances, devices or systems is a Purchaser's own risk and Purchaser agrees to fully indemnify Micrel for any damages resulting from such use or sale.

© 2004 Micrel, Incorporated.

# Mouser Electronics

Authorized Distributor

Click to View Pricing, Inventory, Delivery & Lifecycle Information:

## Microchip:

[MIC94063YC6 TR](#) [MIC94060YMT TR](#) [MIC94062YC6 TR](#) [MIC94061YC6 TR](#) [MIC94062YMT TR](#) [MIC94063YMT TR](#)  
[MIC94061YMT TR](#) [MIC94060YC6 TR](#) [MIC94063YC6-TR](#) [MIC94060YMT-TR](#) [MIC94062YMT-TR](#) [MIC94062YC6-TR](#)  
[MIC94061YC6-TR](#) [MIC94061YMT-TR](#) [MIC94060YC6-TR](#) [MIC94063YMT-TR](#)