

# Solid State Relays

## 5 - 15 - 30 - 50 A

**77**  
SERIES



Drying kilns



Heating and cooling



Lighting control in corridors (for hotels, offices and hospitals)



Bottling plant



Labelling machines



Packaging machines





**5 A modular SSR, 1 NO AC output**

- 17.5 mm housing
- 60 to 240 V AC output (with back to back SCR)
- 5 kV (1.2/50 µs) insulation between Input and Output
- Zero-crossing and random switch-on versions available
- High switching speed
- High endurance
- Silent switching
- Spark and bounce-free switching
- Low control power
- 3-phase general purpose
- 35 mm rail (EN 60715) mount

77.01

Screw terminal



\* See L77-3 diagram page 13

\*\* See L77-1 and L77-2 diagrams page 12

For outline drawing see page 16

**Output specification**

Output configuration	1 NO (SPST-NO)		1 NO (SPST-NO)	
Rated current I <sub>N</sub> /Max. peak current* (10 ms)	A	5/300*	5/300*	
Rated voltage	V AC (50/60 Hz)	230	230	
Switching voltage range	V AC (50/60 Hz)	48...265	48...265	
Repetitive peak off-state voltage	V <sub>pk</sub>	800	800	
Rated load AC7a (cos φ = 0.8)	A	5	5	
Rated load AC15	A	5	3	
Single phase motor rating (230 V AC)	kW	—	0.1	
Nominal lamp rating:				
230 V incandescent/halogen W		1000	800	
fluorescent tubes with electronic ballast W		1000	800	
fluorescent tubes with electromagnetic ballast W		1000	800	
CFL W		800	400	
230 V LED W		800	400	
LV halogen or LED with electronic ballast W		800	400	
LV halogen or LED with electromagnetic ballast W		1000	800	
Minimum switching current @ 230 V	mA	100	100	
Typical "OFF-state" leakage current @ 230 V	mA	0.5	3.5	
Max "ON-state" voltage drop @ 25 °C and 5 A/100 mA	V	0.85/1.5	0.85/1.5	
Power loss @ 5 A	W	4	4	

**Input specification**

Nominal voltage (U <sub>N</sub> )	V AC (50/60 Hz)	24	230	24	230
	V DC	12...24	—	12...24	—
Rated power	VA (50 Hz)/W	0.6/0.5	3.6/0.3	0.6/0.5	3.6/0.3
Operating range	V AC (50/60 Hz)	16...32	90...265	16...32	90...265
	V DC	9.8...32	—	9.8...32	—
Must drop-out voltage	V AC (50/60 Hz)/DC	2.4	24	2.4	24

**Technical data**

Electrical life	cycles	10 · 10 <sup>6</sup>	10 · 10 <sup>6</sup>
Operate/release time	ms	20/12	9/8
Insulation between input and output (1.2/50 µs)	kV	5	5
Ambient temperature	°C	-20...+70**	-20...+70**
Protection category		IP 20	IP 20

**Approvals** (according to type)



**77.01.x.xxx.8050**



**Zero-crossing switch-on  
Suggested applications:**

- Lamp inrush current reduction (CFL - Compact Fluorescent energy-saving Lamps and similar)
- Heater control
- Solenoid, contactor driver

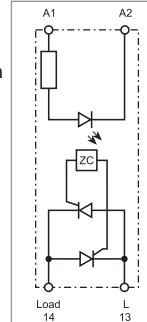

**77.01.x.xxx.8051**



**Random switch-on  
Suggested applications:**

- Finer control requiring short operate time (specially motor control)
- AC Input phase different from AC Output phase

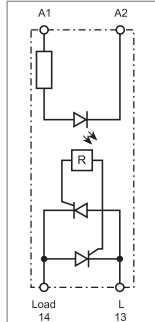

**7 - 15 A modular SSR, 1 NO DC output**

- 17.5 mm housing
- 2 versions, for 24 and 125 V DC mosfet output
- 4 kV (1.2/50  $\mu$ s) insulation between Input and Output
- Short circuit protection
- High switching speed
- High endurance
- Silent switching
- Spark and bounce-free switching
- Low control power
- Suitable for railway applications
- 35 mm rail (EN 60715) mount

77.01

Screw terminal



\* See L77-12 and L77-13 diagrams page 12

For outline drawing see page 16

**Output specification**

Output configuration		1 NO (SPST-NO)	1 NO (SPST-NO)
Rated current $I_N$ /Max. peak current (10 ms)	A	15/160	7/60
Rated voltage	V DC	24	125
Switching voltage range	V DC	16...32	43...140
Rated load DC13	A	5	2.5
DC motor rating	kW	0.2	—
Minimum switching current	mA	100	50
Typical "OFF-state" leakage current	mA	3	6
Max "ON-state" voltage drop @ 25 °C and $I_N$	V	0.06	0.2
Power loss @ $I_N$	W	1	1.5

**Input specification**

Nominal voltage ( $U_N$ )	V DC	6...24	6...24
Rated power	W	0.5	0.5
Operating range	V DC	4...36	4...36
Must drop-out voltage	V DC	3	3

**Technical data**

Electrical life	cycles	$10 \cdot 10^6$	$10 \cdot 10^6$
Operate/release time	ms	0.05/2	0.05/2
Insulation between input and output (1.2/50 $\mu$ s)	kV	4	4
Ambient temperature	°C	-20...+70*	-20...+70*
Protection category		IP 20	IP 20

Approvals (according to type)



**77.01.9.024.9024**



**24 V DC output switching  
15 A rated**

**Applications in Energy, Automation and Machines:**

- Control of electric, pneumatic and hydraulic electromagnetic valves
- Direct control of loads such as motors and electromagnets

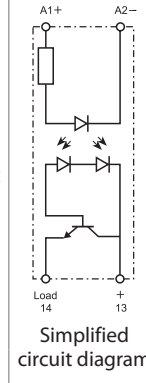

**77.01.9.024.9125**



**110...125 V DC output switching  
7 A rated**

**Applications in Energy, Automation and Machines:**

- Control of electric, pneumatic and hydraulic electromagnetic valves
- Direct control of loads such as motors and electromagnets

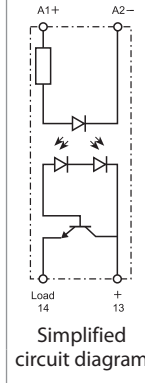

**15 A modular SSR, 1 NO output**

- 22.5 mm housing, heat-sink + plastic cover
- 24 to 277 V AC output (with triac)
- 6 kV (1.2/50 µs) insulation between Input and Output
- Zero-crossing and random switch-on versions available
- High switching speed
- High endurance
- Silent switching
- Spark and bounce-free switching
- Low control power
- 3-phase general purpose
- "Relay-style" terminal arrangement (input and output terminals on opposite sides)
- 35 mm rail (EN 60715) mount

77.11  
Screw terminal



\* See L77-7 diagram page 13  
\*\* See L77-6 diagrams page 12

For outline drawing see page 16

**Output specification**

Output configuration	1 NO (SPST-NO)		1 NO (SPST-NO)	
Rated current I <sub>N</sub> /Max. peak current* (10 ms) A	15/400*		15/400*	
Rated voltage V AC (50/60 Hz)	230		230	
Switching voltage range V AC (50/60 Hz)	19...305		19...305	
Repetitive peak off-state voltage V <sub>pk</sub>	800		800	
Rated load AC7a (cos φ = 0.8, @ 25 °C) A	20		20	
Rated load AC15 A	15		15	
Single phase motor rating (230 V AC) kW	—		0.75	
Nominal lamp rating:				
230 V incandescent/halogen W	4000		2500	
fluorescent tubes with electronic ballast W	4000		2500	
fluorescent tubes with electromagnetic ballast W	2000		1000	
CFL W	3000		1500	
230 V LED W	3000		1500	
LV halogen or LED with electronic ballast W	3000		1500	
LV halogen or LED with electromagnetic ballast W	3000		1500	
Minimum switching current @ 250 V mA	100		100	
Typical "OFF-state" leakage current @ 250 V mA	1		1	
Max "ON-state" voltage drop @ 25 °C and 15 A V	1.55		1.55	
Power loss @ 15 A W	14		14	

**Input specification**

Nominal voltage (U <sub>N</sub> )	V AC (50/60 Hz)	—	230	—	230
	V DC	24	—	24	—
Rated power VA (50 Hz)/W		0.4	7.5/0.9	0.4	7.5/0.9
Operating range	V AC (50/60 Hz)	—	40...305	—	40...305
	V DC	4...32	—	4...32	—
Must drop-out voltage	V AC (50/60 Hz)/DC	—/2	6/—	—/2	6/—

**Technical data**

Electrical life	cycles	10 · 10 <sup>6</sup>		10 · 10 <sup>6</sup>	
Operate/release time	ms	< 10/< 10	< 10/< 30	< 1/< 10	< 2/< 25
Insulation between input and output (1.2/50 µs)	kV	6		6	
Ambient temperature	°C	-20...+80**		-20...+80**	
Protection category		IP 20		IP 20	

**Approvals** (according to type)



**77.11.x.xxx.8250**



**Zero-crossing switch-on**

**Suggested applications:**

- Lamp inrush current reduction (CFL - Compact Fluorescent energy-saving Lamps and similar)
- Heater control
- Solenoid, contactor driver

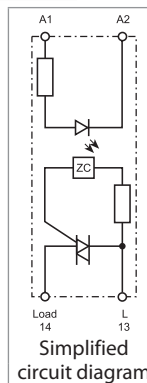

**77.11.x.xxx.8251**



**Random switch-on**

**Suggested applications:**

- Fine controls involving shorter time (specially motor control)

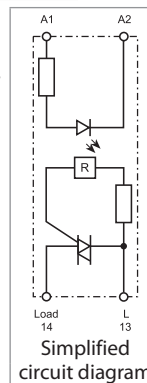

**30 A modular SSR, 1 NO output**

- 22.5 mm housing, heat-sink + plastic cover
- 60 to 440 V AC output (with back to back SCR)
- 6 kV (1.2/50 μs) insulation between Input and Output
- Zero-crossing and random switch-on versions available
- High switching speed
- High endurance
- Silent switching
- Spark and bounce-free switching
- Low control power
- 3-phase general purpose
- "Relay-style" terminal arrangement (input and output terminals on opposite sides)
- 35 mm rail (EN 60715) mount

77.31

Screw terminal



\* See L77-5 diagram page 13

\*\* See L77-4 diagrams page 12

For outline drawing see page 16

**Output specification**

Output configuration	1 NO (SPST-NO)		1 NO (SPST-NO)	
Rated current I <sub>N</sub> /Max. peak current* (10 ms) A	30/520*		30/520*	
Rated voltage V AC (50/60 Hz)	400		400	
Switching voltage range V AC (50/60 Hz)	48...480		48...480	
Repetitive peak off-state voltage V <sub>pk</sub>	1100		1100	
Rated load AC7a (cos φ = 0.8) A	30		30	
Rated load AC15 A	20		20	
Single phase motor rating (230 V AC) kW	—		1.5	
Nominal lamp rating:				
230 V incandescent/halogen W	6000		4500	
fluorescent tubes with electronic ballast W	6000		4000	
fluorescent tubes with electromagnetic ballast W	3000		1800	
CFL W	4000		2500	
230 V LED W	4000		2500	
LV halogen or LED with electronic ballast W	4000		2500	
LV halogen or LED with electromagnetic ballast W	4000		2500	
Minimum switching current @ 400 V mA	300		300	
Typical "OFF-state" leakage current @ 400 V mA	1		1	
Max "ON-state" voltage drop @ 25 °C and 30 A V	0.85		0.85	
Power loss @ 30 A W	16		16	

**Input specification**

Nominal voltage (U <sub>N</sub> )	V AC (50/60 Hz)	—	230	—	230
	V DC	24	—	24	—
Rated power @ U <sub>MAX</sub>	VA (50 Hz)/W	0.4	7.5/0.9	0.4	7.5/0.9
Operating range	V AC (50/60 Hz)	—	40...280	—	40...280
	V DC	4...32	—	4...32	—
Must drop-out voltage	V AC (50/60 Hz)/DC	—/2	6/—	—/2	6/—

**Technical data**

Electrical life	cycles	10 · 10 <sup>6</sup>		10 · 10 <sup>6</sup>	
Operate/release time	ms	< 10/< 10	< 10/< 30	< 1/< 10	< 2/< 25
Insulation between input and output (1.2/50 μs)	kV	6		6	
Ambient temperature	°C	-20...+80**		-20...+80**	
Protection category		IP 20		IP 20	

**Approvals** (according to type)



**77.31.x.xxx.8050**



**Zero-crossing switch-on**  
**Suggested applications:**

- Lamp inrush current reduction (CFL - Compact Fluorescent energy-saving Lamps and similar)
- Heater control
- Solenoid, contactor driver

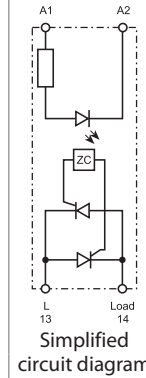

**77.31.x.xxx.8051**



**Random switch-on**  
**Suggested applications:**

- Finer control requiring short operate time (specially motor control)

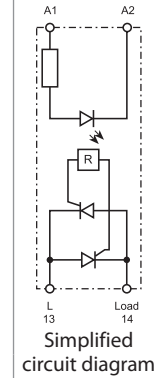

**30 A modular SSR, 1 NO output**

- 22.5 mm housing, heat-sink + plastic cover
- 60 to 440 V AC output (with back to back SCR)
- 6 kV (1.2/50 µs) insulation between Input and Output
- Zero-crossing and random switch-on versions available
- High switching speed
- High endurance
- Silent switching
- Spark and bounce-free switching
- Low control power
- 3-phase general purpose
- "Contactor-style" terminal arrangement (input and output terminals on adjacent sides)
- 35 mm rail (EN 60715) mount

77.31

Screw terminal



\* See L77-5 diagram page 13

\*\* See L77-4 diagrams page 12

For outline drawing see page 16

**Output specification**

Output configuration	1 NO (SPST-NO)		1 NO (SPST-NO)	
Rated current I <sub>N</sub> /Max. peak current* (10 ms) A	30/520*		30/520*	
Rated voltage V AC (50/60 Hz)	400		400	
Switching voltage range V AC (50/60 Hz)	48...480		48...480	
Repetitive peak off-state voltage V <sub>pk</sub>	1100		1100	
Rated load AC7a (cos φ = 0.8) A	30		30	
Rated load AC15 A	20		20	
Single phase motor rating (230 V AC) kW	—		1.5	
Nominal lamp rating:				
230 V incandescent/halogen W	6000		4500	
fluorescent tubes with electronic ballast W	6000		4000	
fluorescent tubes with electromagnetic ballast W	3000		1800	
CFL W	4000		2500	
230 V LED W	4000		2500	
LV halogen or LED with electronic ballast W	4000		2500	
LV halogen or LED with electromagnetic ballast W	4000		2500	
Minimum switching current @ 400 V mA	300		300	
Typical "OFF-state" leakage current @ 400 V mA	1		1	
Max "ON-state" voltage drop @ 25 °C and 30 A V	0.85		0.85	
Power loss @ 30 A W	16		16	

**Input specification**

Nominal voltage (U <sub>N</sub> )	V AC (50/60 Hz)	—	230	—	230
	V DC	24	—	24	—
Rated power VA (50 Hz)/W		0.4	7.5/0.9	0.4	7.5/0.9
Operating range	V AC (50/60 Hz)	—	40...280	—	40...280
	V DC	4...32	—	4...32	—
Must drop-out voltage V AC (50/60 Hz)/DC		—/2	6/—	—/2	6/—

**Technical data**

Electrical life cycles		10 · 10 <sup>6</sup>		10 · 10 <sup>6</sup>	
Operate/release time ms		< 10/< 10	< 10/< 30	< 1/< 10	< 2/< 25
Insulation between input and output (1.2/50 µs) kV		6		6	
Ambient temperature °C		-20...+80**		-20...+80**	
Protection category		IP 20		IP 20	

**Approvals** (according to type)



**77.31.x.xxx.8070**



**Zero-crossing switch-on**

**Suggested applications:**

- Lamp inrush current reduction (CFL - Compact Fluorescent energy-saving Lamps and similar)
- Heater control
- Solenoid, contactor driver

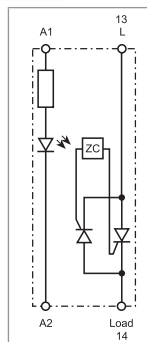

Simplified circuit diagram

**77.31.x.xxx.8071**



**Random switch-on**

**Suggested applications:**

- Fine controls involving shorter time (specially motor control)

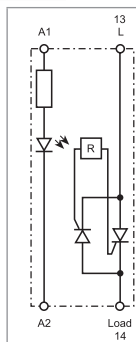

Simplified circuit diagram



**25, 40 And 50 A panel SSR, "hockey puck" style**

- "hockey puck" housing with cover
- 24 to 240 V AC output
- Zero-crossing version
- High switching speed
- High endurance
- Silent switching
- Spark and bounce-free switching
- Low control power
- 3-phase general purpose
- "Relay-style" terminal arrangement (input and output terminals on opposite sides)
- Mounting on heatsink with screws

77.x5  
Screw terminal (plate clamp)



\* See L77-11 diagrams page 13  
\*\* See L77-8, L77-9 and L77-10 diagrams page 13

For outline drawing see page 16

**77.25.x.xxx.8250**



- Zero-crossing switch-on**
- Output: 25 A/230 V AC
  - Suggested applications: heater control

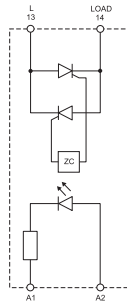

Simplified circuit diagram

**77.45.x.xxx.8250**



- Zero-crossing switch-on**
- Output: 40 A/230 V AC
  - Suggested applications: heater control

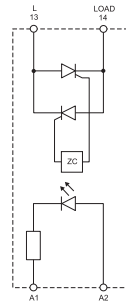

Simplified circuit diagram

**77.55.x.xxx.8250**



- Zero-crossing switch-on**
- Output: 50 A/230 V AC
  - Suggested applications: heater control

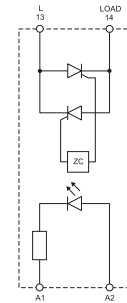

Simplified circuit diagram

**Output specification**

Output configuration		1 NO (SPST-NO)	1 NO (SPST-NO)	1 NO (SPST-NO)
Rated current $I_N$ /Max. peak current* (10 ms) A		25/300*	40/500*	50/520*
Rated voltage V AC (50/60 Hz)		230	230	230
Switching voltage range V AC (50/60 Hz)		21.6...280	21.6...280	21.6...280
Repetitive peak off-state voltage $V_{pk}$		600	600	600
Nominal lamp rating:				
230 V incandescent/halogen W		2000	4000	6000
fluorescent tubes with electronic ballast W		2000	4000	6000
fluorescent tubes with electromagnetic ballast W		1000	2000	3000
CFL W		800	3000	4000
230 V LED W		800	3000	4000
LV halogen or LED with electronic ballast W		800	3000	4000
LV halogen or LED with electromagnetic ballast W		1000	3000	4000
Minimum switching current @ 250 V mA		120	250	250
Typical "OFF-state" leakage current @ 250 V mA		10	10	10
Max "ON-state" voltage drop @ 25 °C and $I_N$ V		1.6	1.6	1.6
Power loss @ $I_N$ W		40	64	80

**Input specification**

Nominal voltage ( $U_N$ )	V AC (50/60 Hz)	—	230	—	230	—	230
	V DC	24	—	24	—	24	—
Rated power @ $U_{MAX}$	VA (50 Hz)/W	—/0.6	2.4/—	—/0.6	2.4/—	—/0.6	2.4/—
Operating range	V AC (50/60 Hz)	—	90...280	—	90...280	—	90...280
	V DC	3...32	—	3...32	—	3...32	—
Must drop-out voltage	V AC (50/60 Hz)/DC	—/1	10/—	—/1	10/—	—/1	10/—

**Technical data**

Electrical life	cycles	10 · 10 <sup>6</sup>		10 · 10 <sup>6</sup>		10 · 10 <sup>6</sup>	
Operate/release time	ms	10/10	40/80	10/10	40/80	10/10	40/80
Insulation between input and output (1.2/50 μs)	kV	5.6		5.6		5.6	
Ambient temperature	°C	-30...+80**		-30...+80**		-30...+80**	
Protection category		IP 20		IP 20		IP 20	

**Approvals** (according to type)





### 25, 40 And 50 A panel SSR, "hockey puck" style

- "hockey puck" housing with cover
- 48 to 600 V AC output
- Zero-crossing version
- High switching speed
- High endurance
- Silent switching
- Spark and bounce-free switching
- Low control power
- 3-phase general purpose
- "Relay-style" terminal arrangement (input and output terminals on opposite sides)
- Mounting on heatsink with screws

77.x5

Screw terminal (plate clamp)



\* See L77-11 diagrams page 13

\*\* See L77-8, L77-9 and L77-10 diagrams page 13

For outline drawing see page 16

#### Output specification

Output configuration

Rated current  $I_N$ /Max. peak current\* (10 ms) A

Rated voltage V AC (50/60 Hz)

Switching voltage range V AC (50/60 Hz)

Repetitive peak off-state voltage  $V_{pk}$

Nominal lamp rating:

230 V incandescent/halogen W

fluorescent tubes with

electronic ballast W

fluorescent tubes with

electromagnetic ballast W

CFL W

230 V LED W

LV halogen or LED with

electronic ballast W

LV halogen or LED with

electromagnetic ballast W

Minimum switching current @ 250 V mA

Typical "OFF-state" leakage current @ 250 V mA

Max "ON-state" voltage drop @ 25 °C and  $I_N$  V

Power loss @  $I_N$  W

#### Input specification

Nominal voltage ( $U_N$ ) V AC (50/60 Hz)

V DC

Rated power @  $U_{MAX}$  VA (50 Hz)/W

Operating range V AC (50/60 Hz)

V DC

Must drop-out voltage V AC (50/60 Hz)/DC

Technical data

Electrical life cycles

Operate/release time ms

Insulation between input and output (1.2/50  $\mu$ s) kV

Ambient temperature °C

Protection category

Approvals (according to type)

### 77.25.x.xxx.8650



#### Zero-crossing switch-on

- Output: 25 A/600 V AC
- Suggested applications: heater control

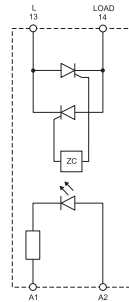

### 77.45.x.xxx.8650



#### Zero-crossing switch-on

- Output: 40 A/600 V AC
- Suggested applications: heater control

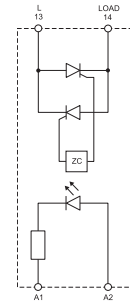

### 77.55.x.xxx.8650



#### Zero-crossing switch-on

- Output: 50 A/600 V AC
- Suggested applications: heater control

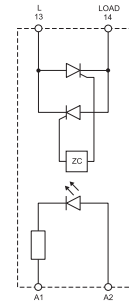

Output specification	77.25.x.xxx.8650	77.45.x.xxx.8650	77.55.x.xxx.8650
Output configuration	1 NO (SPST-NO)	1 NO (SPST-NO)	1 NO (SPST-NO)
Rated current $I_N$ /Max. peak current* (10 ms) A	25/300*	40/500*	50/520*
Rated voltage V AC (50/60 Hz)	600	600	600
Switching voltage range V AC (50/60 Hz)	43.2...660	43.2...660	43.2...660
Repetitive peak off-state voltage $V_{pk}$	1200	1200	1200
Nominal lamp rating:			
230 V incandescent/halogen W	2000	4000	6000
fluorescent tubes with electronic ballast W	2000	4000	6000
fluorescent tubes with electromagnetic ballast W	1000	2000	3000
CFL W	800	3000	4000
230 V LED W	800	3000	4000
LV halogen or LED with electronic ballast W	800	3000	4000
LV halogen or LED with electromagnetic ballast W	1000	3000	4000
Minimum switching current @ 250 V mA	120	250	250
Typical "OFF-state" leakage current @ 250 V mA	10	10	10
Max "ON-state" voltage drop @ 25 °C and $I_N$ V	1.6	1.6	1.6
Power loss @ $I_N$ W	40	64	80
Input specification			
Nominal voltage ( $U_N$ ) V AC (50/60 Hz)	—	230	230
V DC	24	—	24
Rated power @ $U_{MAX}$ VA (50 Hz)/W	—/0.6	2.4/—	—/0.6
Operating range V AC (50/60 Hz)	—	90...280	—
V DC	4...32	—	4...32
Must drop-out voltage V AC (50/60 Hz)/DC	—/1	10/—	—/1
Technical data			
Electrical life cycles	10 · 10 <sup>6</sup>	10 · 10 <sup>6</sup>	10 · 10 <sup>6</sup>
Operate/release time ms	10/10	40/80	10/10
Insulation between input and output (1.2/50 $\mu$ s) kV	5.6	5.6	5.6
Ambient temperature °C	-30...+80**	-30...+80**	-30...+80**
Protection category	IP 20	IP 20	IP 20
Approvals (according to type)			

## Ordering information

Example: 77 series modular SSR, 1 output 30 A AC, input voltage 230 V AC, relay style terminals arrangement, zero-crossing switch-on.

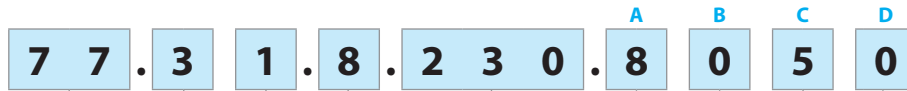

<b>Series</b>	<b>D: Switch-on mode</b> 0 = Zero-crossing 1 = Random
<b>Type/rated current</b> 0 = 5/7/15 A output (77.01) 1 = 15 A output (77.11) 2 = 25 A output (77.25) 3 = 30 A output (77.31) 4 = 40 A output (77.45) 5 = 50 A output (77.55)	<b>C: Terminals arrangement</b> 5 = "Relay style" (input and output on opposite sides) 7 = "Contactor style" (input and output on adjacent sides)
<b>No. of poles/mounting</b> 1 = 1 pole, modular housing (plastic or heat sink/plastic), DIN rail mounting 5 = 1 pole, heat-sink or directly panel mounting ("hockey puck")	<b>AB: Output circuit</b> (rated voltage) 80 = 230 V AC (77.01), 400 V AC (77.31) 82 = 230 V AC (77.11, 77.x5) 86 = 600 V AC (77.x5) 9024 = 24 V DC 9125 = 110...125 V DC
<b>Input version</b> 0 = DC/AC (50/60 Hz) 8 = AC (50/60 Hz) 9 = DC	
<b>Supply voltage</b> See "input specification"	

### Codes/Module width

77.01.8.230.8050/17.5 mm 5 A	77.11.8.230.8250/22.5 mm 15 A	77.31.8.230.8050/22.5 mm 30 A	77.25.8.230.8250/hockey puck 25 A
77.01.0.024.8050/17.5 mm 5 A	77.11.9.024.8250/22.5 mm 15 A	77.31.9.024.8050/22.5 mm 30 A	77.25.9.024.8250/hockey puck 25 A
77.01.8.230.8051/17.5 mm 5 A	77.11.8.230.8251/22.5 mm 15 A	77.31.8.230.8051/22.5 mm 30 A	77.25.8.230.8650/hockey puck 25 A
77.01.0.024.8051/17.5 mm 5 A	77.11.9.024.8251/22.5 mm 15 A	77.31.9.024.8051/22.5 mm 30 A	77.25.9.024.8650/hockey puck 25 A
77.01.9.024.9125/17.5 mm 7 A		77.31.8.230.8070/22.5 mm 30 A	77.45.8.230.8250/hockey puck 25 A
77.01.9.024.9024/17.5 mm 15 A		77.31.9.024.8070/22.5 mm 30 A	77.45.9.024.8250/hockey puck 40 A
		77.31.8.230.8071/22.5 mm 30 A	77.45.8.230.8650/hockey puck 40 A
		77.31.9.024.8071/22.5 mm 30 A	77.45.9.024.8650/hockey puck 40 A
			77.55.8.230.8250/hockey puck 50 A
			77.55.9.024.8250/hockey puck 50 A
			77.55.8.230.8650/hockey puck 50 A
			77.55.9.024.8650/hockey puck 50 A

## Technical data

		77.01.8xxx		77.01.9xxx		77.11		77.31		77.25/45/55			
		Dielectric strength	Impulse (1.2/50 µs)	Dielectric strength	Impulse (1.2/50 µs)	Dielectric strength	Impulse (1.2/50 µs)	Dielectric strength	Impulse (1.2/50 µs)	Dielectric strength	Impulse (1.2/50 µs)		
Between input and output		2500 V AC	5 kV	3000 V AC	4 kV	3000 V AC	6 kV	3000 V AC	6 kV	4000 V AC	5.6 kV		
Between input and ground (heat-sink)		—	—	—	—	3000 V AC	6 kV	3000 V AC	6 kV	4000 V AC	5.6 kV		
Between output and ground (heat-sink)		—	—	—	—	2500 V AC	4 kV	4000 V AC	6 kV	4000 V AC	5.6 kV		
EMC specifications		Reference standard		77.01.x.xxx		77.01.9.xxx		77.11		77.31		77.25/45/55	
		24 V AC/DC, 230 V AC		24 V DC		24 V DC, 230 V AC		24 V DC, 230 V AC		24 V DC, 230 V AC		24 V DC - 230 V AC	
Electrostatic discharge	contact discharge	EN 61000-4-2		4 kV		4 kV		4 kV		4 kV		4 kV	
	air discharge	EN 61000-4-2		8 kV		8 kV		8 kV		8 kV		8 kV	
Radiated electromagnetic field (80...1000 MHz)		EN 61000-4-3		30 V/m		—		20 V/m		30 V/m		—	
Fast transients on supply terminals (burst 5/50 ns, 5 and 100 kHz)		EN 61000-4-4		1 kV, 4 kV		2 kV		1 kV, 3 kV		1 kV, 3 kV		2 kV	
Voltage pulses on supply terminals (surge 1.2/50 µs)	common mode	EN 61000-4-5		2 kV, 4 kV		1 kV		3 kV, 3 kV		3 kV, 3 kV		2 kV	
	differential mode	EN 61000-4-5		1 kV, 4 kV		0.5 kV		0.5 kV, 1.5 kV		0.5 kV, 1.5 kV		1 kV	
Radio-frequency common mode voltage (0.15...230 MHz) on supply terminals		EN 61000-4-6		—		10 V		10 V		10 V		—	
Terminals		77.01.x.xxx		77.01.9.xxx		77.11		77.31		77.25/45/55		Input Output	
Screw torque		Nm		0.8		0.8		0.8		0.8		0.5, 1.2	
Max. wire size		solid cable, stranded cable		solid cable, stranded cable		solid cable, stranded cable		solid cable, stranded cable		solid cable, stranded cable		solid and stranded cable	
		mm <sup>2</sup>		mm <sup>2</sup>		mm <sup>2</sup>		mm <sup>2</sup>		mm <sup>2</sup>		mm <sup>2</sup>	
		1x6/ 2x4		1x4/ 2x25		1x6/ 2x4		1x4/ 2x25		1x6/ 2x4		1x6/ 2x4	
		AWG		AWG		AWG		AWG		AWG		AWG	
		1x10/ 2x12		1x12/ 2x14		1x10/ 2x12		1x12/ 2x14		1x10/ 2x12		1x10/ 2x12	
Wire strip length		mm		9		9		9		9		10, 10	
Other data													
Power lost to the environment without output current		W		0.5		0.5		0.9		0.9		0.6	
with rated current		W		4.0		4.0		14		16		40/64/80	

## Input specification

### 77.01

Nominal voltage	Input code	Operating range				Must drop-out voltage (AC/DC)	Input current $I_N$ at $U_N$
		AC		DC			
		$U_{min}$	$U_{max}$	$U_{min}$	$U_{max}$		
$U_N$		V	V	V	V	V	mA
24	0.024	16	32	9.8	32	2.4	25
24	9.024	—	—	4	32	3.0	18
230	8.230	90	265	—	—	24	15

### 77.11

Nominal voltage	Input code	Operating range				Must drop-out voltage (AC/DC)	Input current $I_N$ at $U_N$
		AC		DC			
		$U_{min}$	$U_{max}$	$U_{min}$	$U_{max}$		
$U_N$		V	V	V	V	V	mA
24	9.024	—	—	4	32	2	11
230	8.230	40	305	—	—	6	25

### 77.31

Nominal voltage	Input code	Operating range				Must drop-out voltage (AC/DC)	Input current $I_N$ at $U_N$
		AC		DC			
		$U_{min}$	$U_{max}$	$U_{min}$	$U_{max}$		
$U_N$		V	V	V	V	V	mA
24	9.024	—	—	4	32	2	11
230	8.230	40	280	—	—	6	25

### 77.x5.x.xxx.8250

Nominal voltage	Input code	Operating range				Must drop-out voltage (AC/DC)	Input current $I_N$ at $U_N$
		AC		DC			
		$U_{min}$	$U_{max}$	$U_{min}$	$U_{max}$		
$U_N$		V	V	V	V	V	mA
24	9.024	—	—	3	32	1	22
230	8.230	90	280	—	—	10	20

### 77.x5.x.xxx.8650

Nominal voltage	Input code	Operating range				Must drop-out voltage (AC/DC)	Input current $I_N$ at $U_N$
		AC		DC			
		$U_{min}$	$U_{max}$	$U_{min}$	$U_{max}$		
$U_N$		V	V	V	V	V	mA
24	9.024	—	—	4	32	1	25
230	8.230	90	280	—	—	10	10

## Led indication

LED	Supply voltage
	OFF
	ON

LED (77.01.9.024.9xxx only)	Short circuit*
	NO
	YES

\* To restore normal operation it is necessary to disconnect the power, resolve the short circuit and then restore power.

D

## Output specification

**L77-1 Output RMS current v ambient temperature**  
77.01.0.024.805x @ 32 V DC

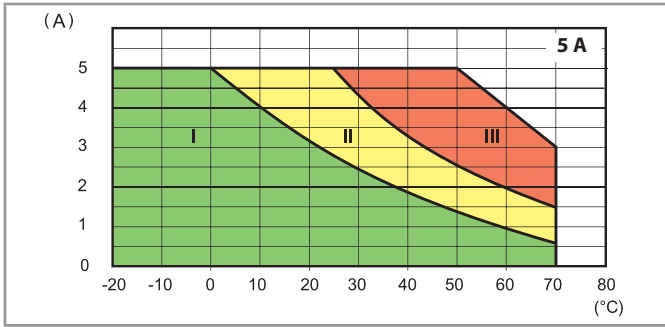

**L77-2 Output RMS current v ambient temperature**  
77.01.8.230.805x @ 265 V AC

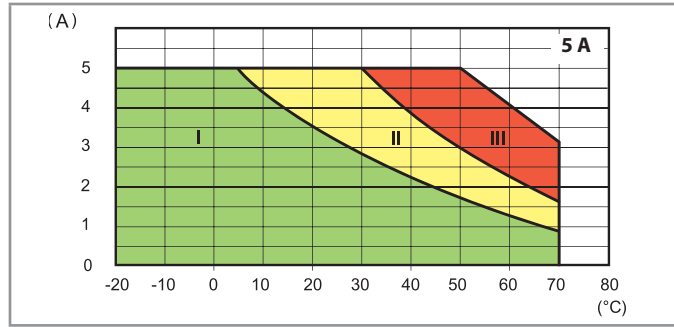

- I - Modular SSR installed as a group (without gap)
- II - Modular SSR installed as a group (9 mm gap between each SSR)
- III - Modular SSR installed individually in free air (without a significant influence from nearby components)

**L77-12 Output DC current v ambient temperature**  
77.01.9.024.9024 @ 32 V DC

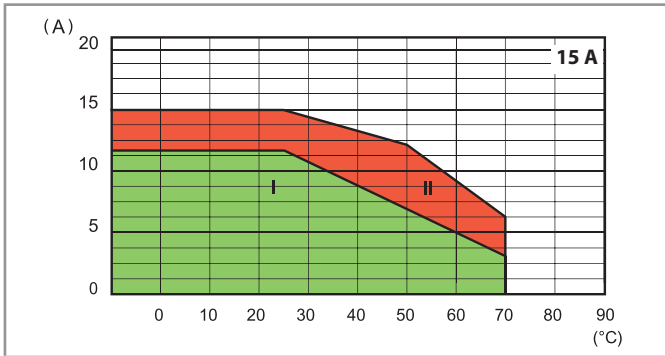

**L77-13 Output DC current v ambient temperature**  
77.01.9.024.9125 @ 32 V DC

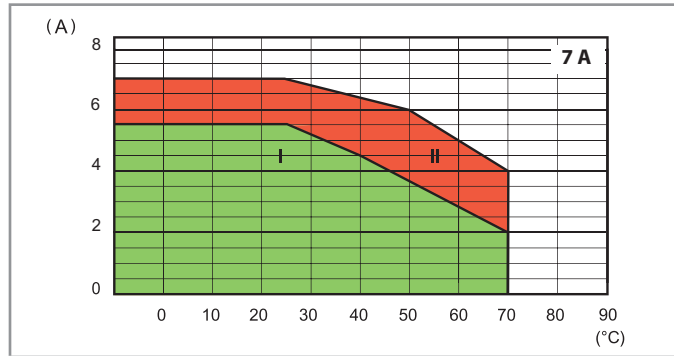

- I - Modular SSR installed as a group (without gap)
- II - Modular SSR installed individually in free air, or with a gap  $\geq 9$  mm, which implies a not significant influence from nearby components

**L77-6 Output RMS current v ambient temperature**  
77.11.x.xxx.82xx

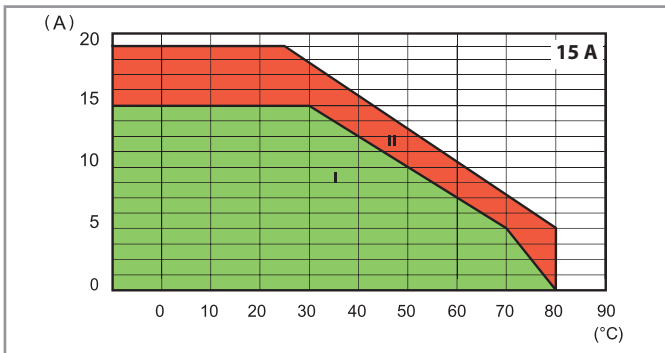

**L77-4 Output RMS current v ambient temperature**  
77.31.x.xxx.80xx

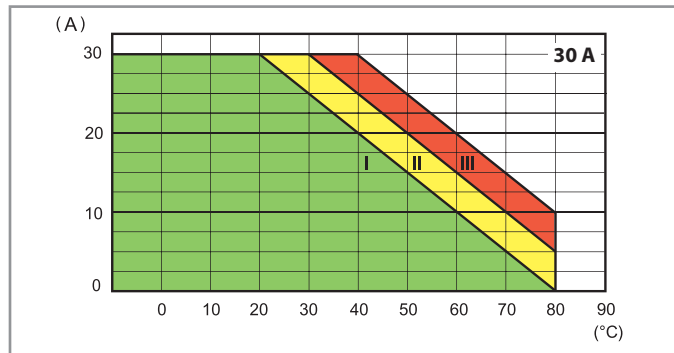

- I - Modular SSR installed as a group (without gap)
- II - Modular SSR installed as a group (20 mm gap between each SSR)
- III - Modular SSR installed individually in free air, or with a gap  $\geq 40$  mm, which implies a not significant influence from nearby components)

## Output specification

**L77-10 Output RMS current v ambient temperature**  
77.25.x.xxx.8x50

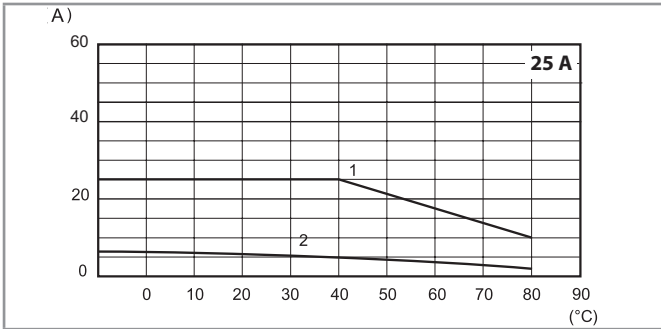

- 1 - Installation on 077.25 heat-sink (2 K/W)
- 2 - Installation individually in free-air

**L77-9 Output RMS current v ambient temperature**  
77.45.x.xxx.8x50

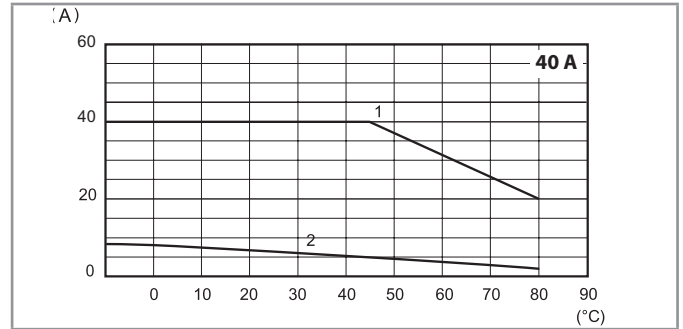

- 1 - Installation on 077.55 heat-sink (0.9 K/W)
- 2 - Installation individually in free-air

**L77-8 Output RMS current v ambient temperature**  
77.55.x.xxx.8x50

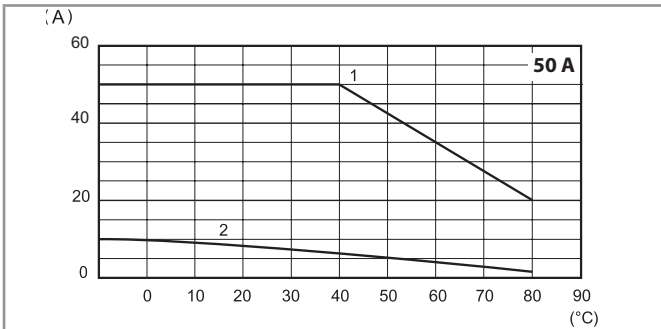

- 1 - Installation on 077.55 heat-sink (0.9 K/W)
- 2 - Installation individually in free-air

**L77-3 Inrush peak current (AC) v inrush time**  
77.01.x.xxx.80xx

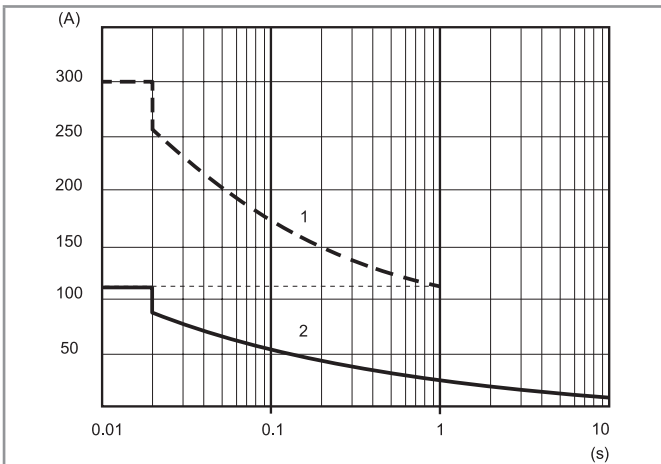

**L77-7 Inrush peak current (AC) v inrush time**  
77.11.x.xxx.82xx

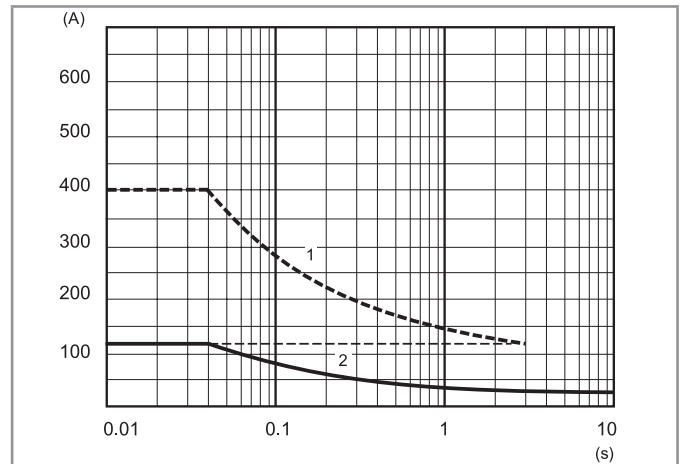

**L77-5 Inrush peak current (AC) v inrush time**  
77.31.x.xxx.80xx

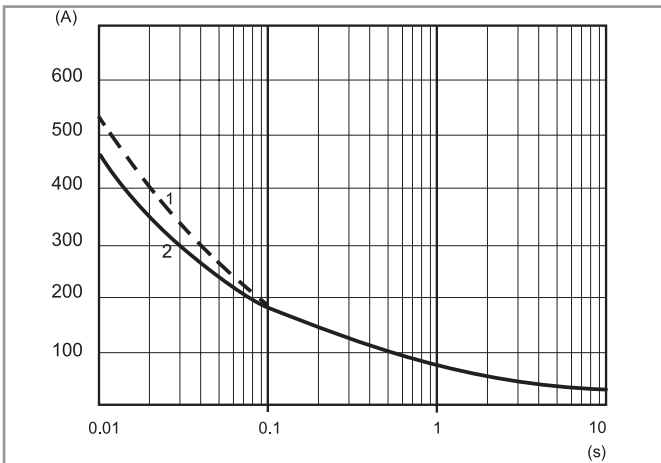

**L77-11 Inrush peak current (AC) v inrush time**  
77x5.x.xxx.8x50

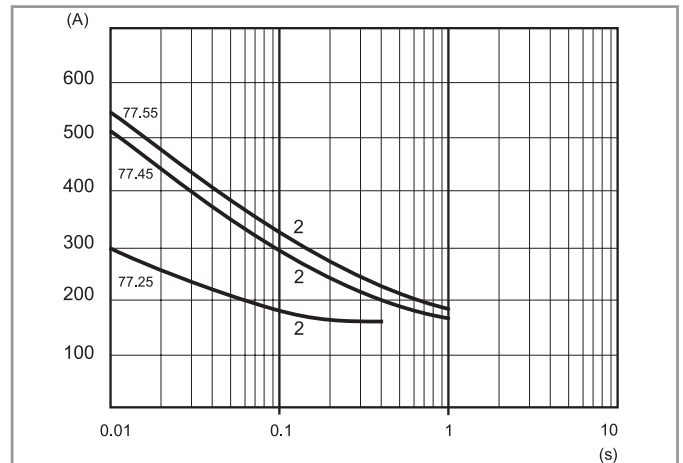

- 1 - "Cold" conditions (ambient temperature = 23 °C, no output current during the last 15 minutes)
- 2 - "Hot" conditions (ambient temperature = 50 °C, rated output current)

## Output specification

Max recommended switching frequency (Cycles/Hour, with 50% Duty-cycle)							
Load	77.01.8xxx	77.01.9xxx	77.11	77.31	77.25	77.45	77.55
5 A 230 V (AC1)	5000	—	—	—	—	—	—
5 A 24 V DC L/R = 20 ms	—	3600	—	—	—	—	—
1 A (AC15)	10000	—	—	—	—	—	—
0.5 A (AC15)	20000	—	—	—	—	—	—
15 A 305 V $\cos \varphi = 0.8$	—	—	1800	—	—	—	—
15 A 305 V $\cos \varphi = 0.5$	—	—	1200	—	—	—	—
30 A 480 V $\cos \varphi = 0.8$	—	—	—	1800	—	—	—
30 A 480 V $\cos \varphi = 0.5$	—	—	—	1200	—	—	—
25 A 230 V $\cos \varphi = 0.7$	—	—	—	—	1800	—	—
40 A 230 V $\cos \varphi = 0.7$	—	—	—	—	—	1800	—
50 A 230 V $\cos \varphi = 0.7$	—	—	—	—	—	—	1800

## Other data

	77.01.8xxx	77.01.9xxx	77.11	77.31	77.25	77.45	77.55
<b>Critical rising voltage</b> dv/dt without input control (gate open) @ $T_j = 125^\circ\text{C}$	> 1000 V/ $\mu\text{s}$	> 1000 V/ $\mu\text{s}$	> 500 V/ $\mu\text{s}$ > 10 V/ $\mu\text{s}$ (with di/dt = 20 A/ms)	> 1000 V/ $\mu\text{s}$	300 V/ $\mu\text{s}$ (.8250)  500 V/ $\mu\text{s}$ (.8650)	500 V/ $\mu\text{s}$ (.8250)  1000 V/ $\mu\text{s}$ (.8650)	1000 V/ $\mu\text{s}$ (.8250)  1000 V/ $\mu\text{s}$ (.8650)
<b>Critical rising current</b> di/dt @ $T_j = 125^\circ\text{C}$	> 50 A/ $\mu\text{s}$	> 50 A/ $\mu\text{s}$	> 50 A/ $\mu\text{s}$	> 150 A/ $\mu\text{s}$	—	—	—
<b>I<sup>2</sup>t for fusing</b> @ $t_p = 10\text{ ms}$	450 A <sup>2</sup> s	450 A <sup>2</sup> s	1000 A <sup>2</sup> s*	1350 A <sup>2</sup> s**	450 A <sup>2</sup> s	1250 A <sup>2</sup> s	1350 A <sup>2</sup> s

Suggested fuse (depending on application) for short-circuit protection (Ultra-Fast acting types for semiconductors):

\* 20 A, 660 V AC, 10 x 38 mm, 200 kA, 360 A<sup>2</sup>s.

\*\* 30 A, 660 V AC, 10 x 38 mm, 200 kA, 1000 A<sup>2</sup>s.

Wiring diagrams

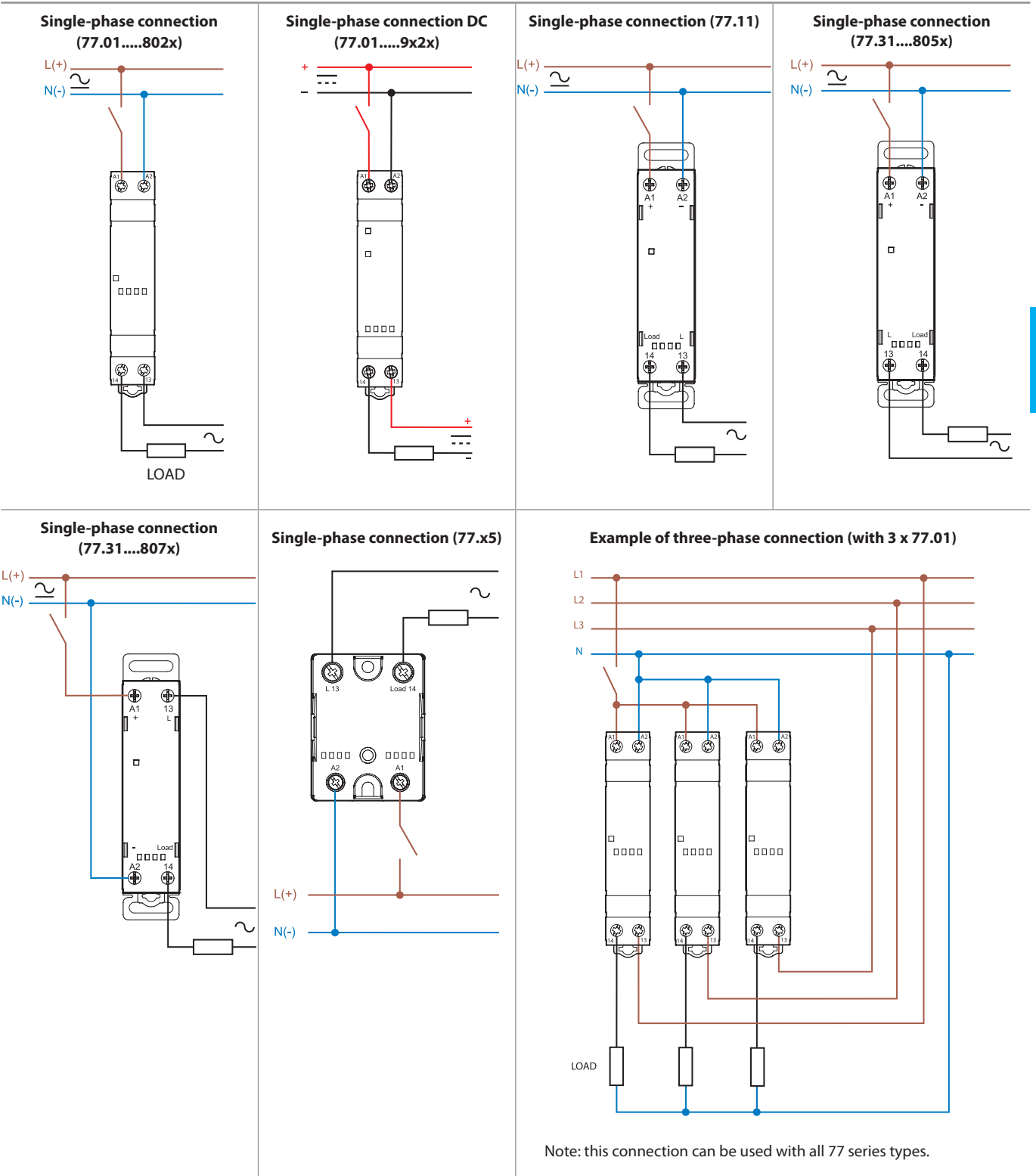



### Outline drawings

Type 77.01  
Screw terminal

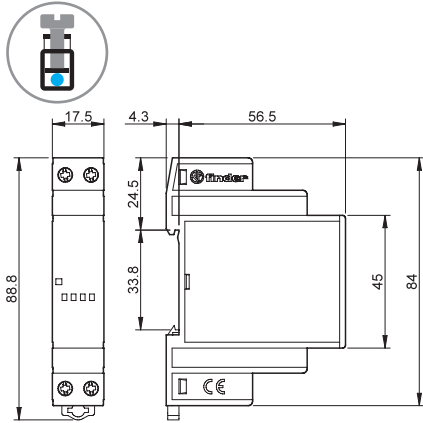

Types 77.11/31  
Screw terminal

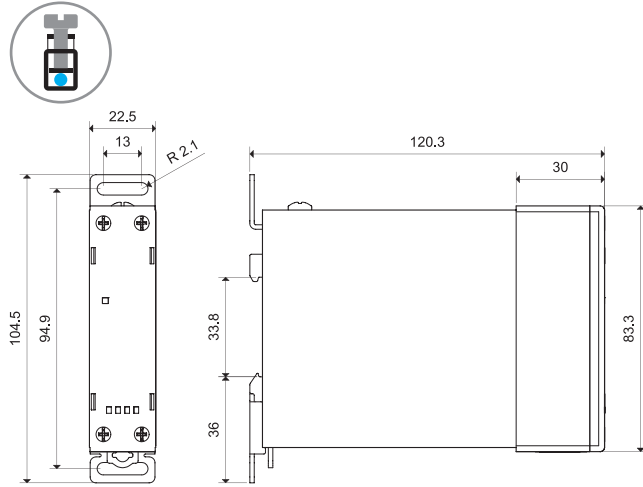

Type 77.01 DC  
Screw terminal

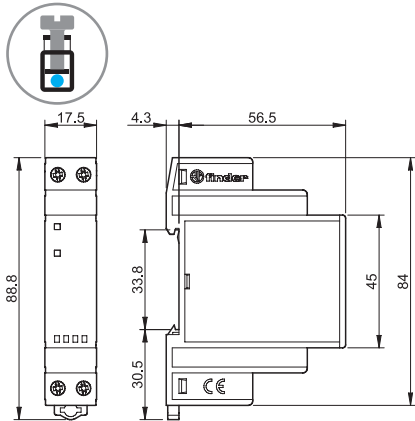

Type 77.x5  
Screw terminal (plate clamp)

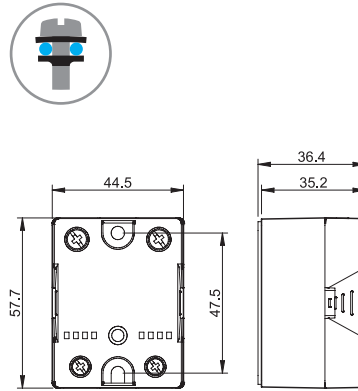

### Accessories



Adaptor for panel mounting, plastic, 17.5 mm wide for 77.01 only

020.01

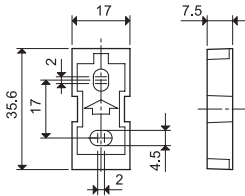

Separator for rail mounting, plastic, 9 mm wide

022.09

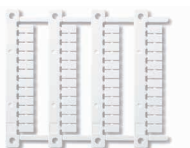
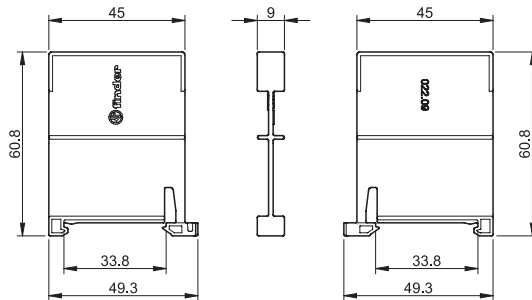

Sheet of marker tags (CEMBRE Thermal transfer printers) for all relays (48 tags), 6 x 12 mm

060.48

060.48

Accessories



077.25

**Heat-sink**, anodized aluminium, 2 K/W, 65 x 100 mm, for 77.25 only | 077.25

- Both the SSR and 35 mm rail clip mount to the heat-sink using M4 screws (supplied with heat-sink)
- Before assembling to the heat-sink, it is necessary to apply a thin and even layer of thermal conductive paste (not supplied) to the lower metal surface of the SSR

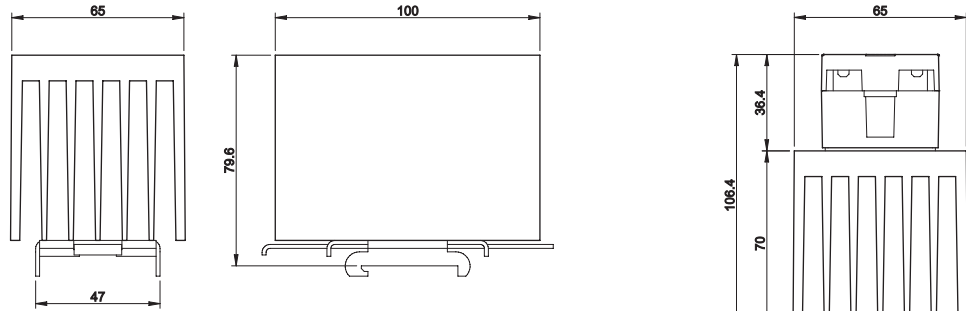

077.25 with 77.25

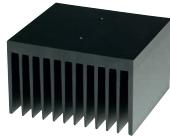

077.55

**Heat-sink**, anodized aluminium, 0.9 K/W, 111 x 100 mm, for 77.45 and 77.55 | 077.55

- Both the SSR and 35 mm rail clip mount to the heat-sink using M4 screws (supplied with heat-sink)
- Before assembling to the heat-sink, it is necessary to apply a thin and even layer of thermal conductive paste (not supplied) to the lower metal surface of the SSR

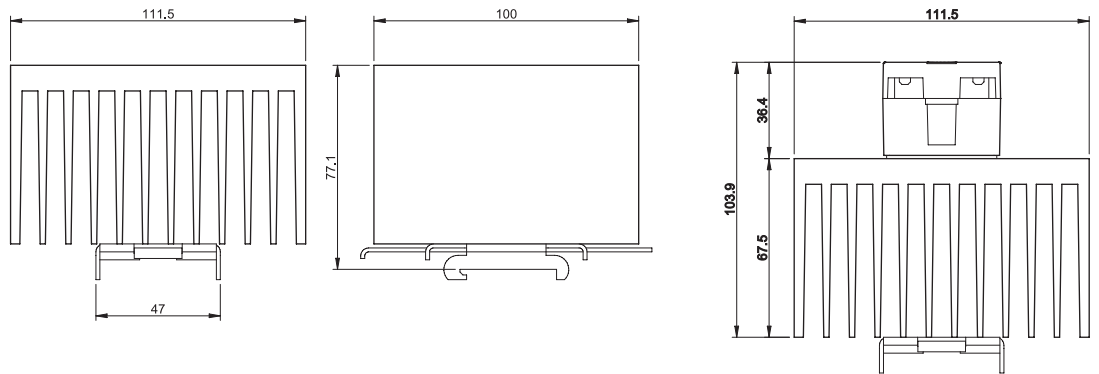

077.55 with 77.45/55



