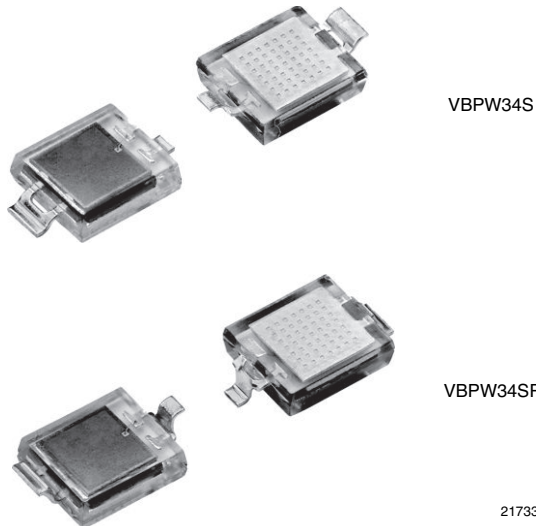




Silicon PIN Photodiode



FEATURES

- Package type: surface mount
- Package form: GW, RGW
- Dimensions (L x W x H in mm): 6.4 x 3.9 x 1.2
- Radiant sensitive area (in mm²): 7.5
- High photo sensitivity
- High radiant sensitivity
- Suitable for visible and near infrared radiation
- Fast response times
- Angle of half sensitivity: $\phi = \pm 65^\circ$
- Floor life: 168 h, MSL 3, acc. J-STD-020
- Lead (Pb)-free reflow soldering
- Compliant to RoHS Directive 2002/95/EC and in accordance to WEEE 2002/96/EC
- Halogen-free according to IEC 61249-2-21 definition



DESCRIPTION

VBPW34S and VBPW34SR are high speed and high sensitive PIN photodiodes. It is a surface mount device (SMD) including the chip with a 7.5 mm² sensitive area detecting visible and near infrared radiation.

APPLICATIONS

- High speed photo detector

PRODUCT SUMMARY			
COMPONENT	I _{ra} (μA)	φ (deg)	λ0.1 (nm)
VBPW34S	55	± 65	430 to 1100
VBPW34SR	55	± 65	430 to 1100

Note

- Test conditions see table “Basic Characteristics”

ORDERING INFORMATION			
ORDERING CODE	PACKAGING	REMARKS	PACKAGE FORM
VBPW34S	Tape and reel	MOQ: 1000 pcs, 1000 pcs/reel	Gullwing
VBPW34SR	Tape and reel	MOQ: 1000 pcs, 1000 pcs/reel	Reverse gullwing

Note

- MOQ: minimum order quantity

ABSOLUTE MAXIMUM RATINGS (T _{amb} = 25 °C, unless otherwise specified)				
PARAMETER	TEST CONDITION	SYMBOL	VALUE	UNIT
Reverse voltage		V _R	60	V
Power dissipation	T _{amb} ≤ 25 °C	P _V	215	mW
Junction temperature		T _j	100	°C
Operating temperature range		T _{amb}	- 40 to + 100	°C
Storage temperature range		T _{stg}	- 40 to + 100	°C
Soldering temperature	Acc. reflow solder profile fig. 8	T _{sd}	260	°C
Thermal resistance junction/ambient		R _{thJA}	350	K/W

BASIC CHARACTERISTICS ($T_{amb} = 25\text{ }^{\circ}\text{C}$, unless otherwise specified)						
PARAMETER	TEST CONDITION	SYMBOL	MIN.	TYP.	MAX.	UNIT
Forward voltage	$I_F = 50\text{ mA}$	V_F		1	1.3	V
Breakdown voltage	$I_R = 100\text{ }\mu\text{A}$, $E = 0$	$V_{(BR)}$	60			V
Reverse dark current	$V_R = 10\text{ V}$, $E = 0$	I_{ro}		2	30	nA
Diode capacitance	$V_R = 0\text{ V}$, $f = 1\text{ MHz}$, $E = 0$	C_D		70		pF
	$V_R = 3\text{ V}$, $f = 1\text{ MHz}$, $E = 0$	C_D		25	40	pF
Open circuit voltage	$E_e = 1\text{ mW/cm}^2$, $\lambda = 950\text{ nm}$	V_o		350		mV
Temperature coefficient of V_o	$E_e = 1\text{ mW/cm}^2$, $\lambda = 950\text{ nm}$	TK_{V_o}		-2.6		mV/K
Short circuit current	$E_e = 1\text{ mW/cm}^2$, $\lambda = 950\text{ nm}$	I_k		50		μA
Temperature coefficient of I_k	$E_e = 1\text{ mW/cm}^2$, $\lambda = 950\text{ nm}$	TK_{I_k}		0.1		%/K
Reverse light current	$E_e = 1\text{ mW/cm}^2$, $\lambda = 950\text{ nm}$, $V_R = 5\text{ V}$	I_{ra}	45	55		μA
Angle of half sensitivity		ϕ		± 65		deg
Wavelength of peak sensitivity		λ_p		940		nm
Range of spectral bandwidth		$\lambda_{0.1}$		430 to 1100		nm
Noise equivalent power	$V_R = 10\text{ V}$, $\lambda = 950\text{ nm}$	NEP		4×10^{-14}		$\text{W}/\sqrt{\text{Hz}}$
Rise time	$V_R = 10\text{ V}$, $R_L = 1\text{ k}\Omega$, $\lambda = 820\text{ nm}$	t_r		100		ns
Fall time	$V_R = 10\text{ V}$, $R_L = 1\text{ k}\Omega$, $\lambda = 820\text{ nm}$	t_f		100		ns

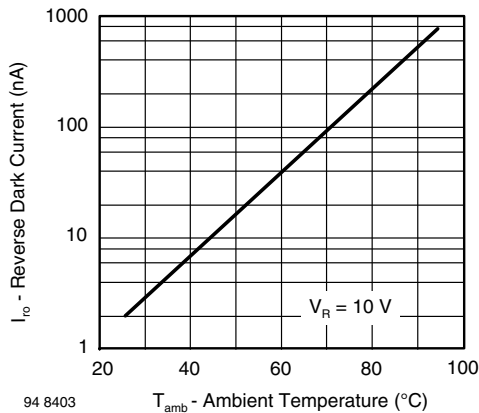
BASIC CHARACTERISTICS ($T_{amb} = 25\text{ }^{\circ}\text{C}$, unless otherwise specified)


Fig. 1 - Reverse Dark Current vs. Ambient Temperature

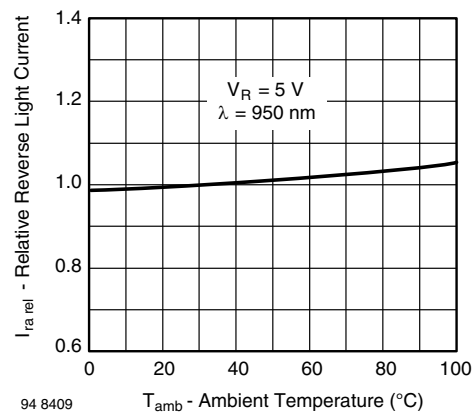


Fig. 2 - Relative Reverse Light Current vs. Ambient Temperature

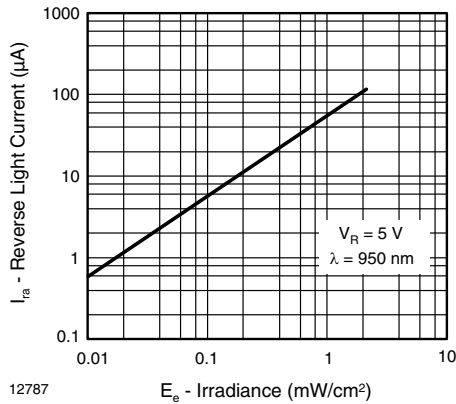


Fig. 3 - Reverse Light Current vs. Irradiance

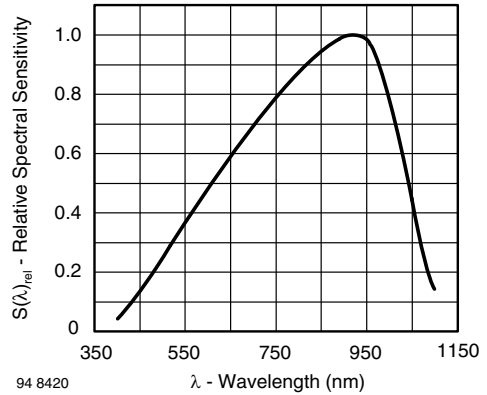


Fig. 6 - Relative Spectral Sensitivity vs. Wavelength

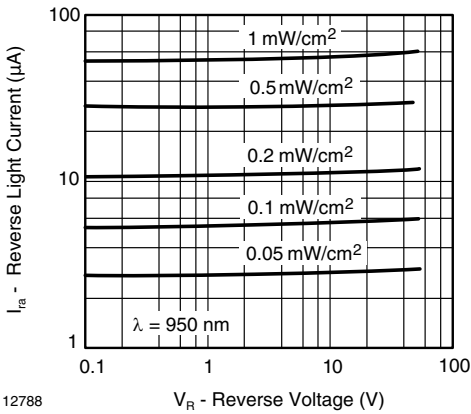


Fig. 4 - Reverse Light Current vs. Reverse Voltage

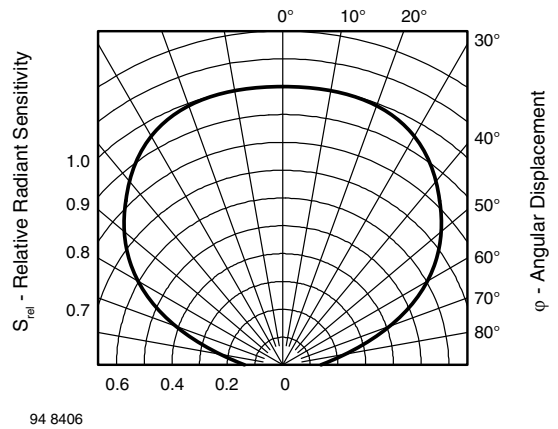


Fig. 7 - Relative Radiant Sensitivity vs. Angular Displacement

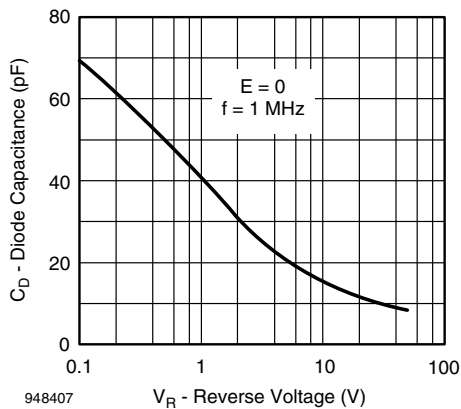
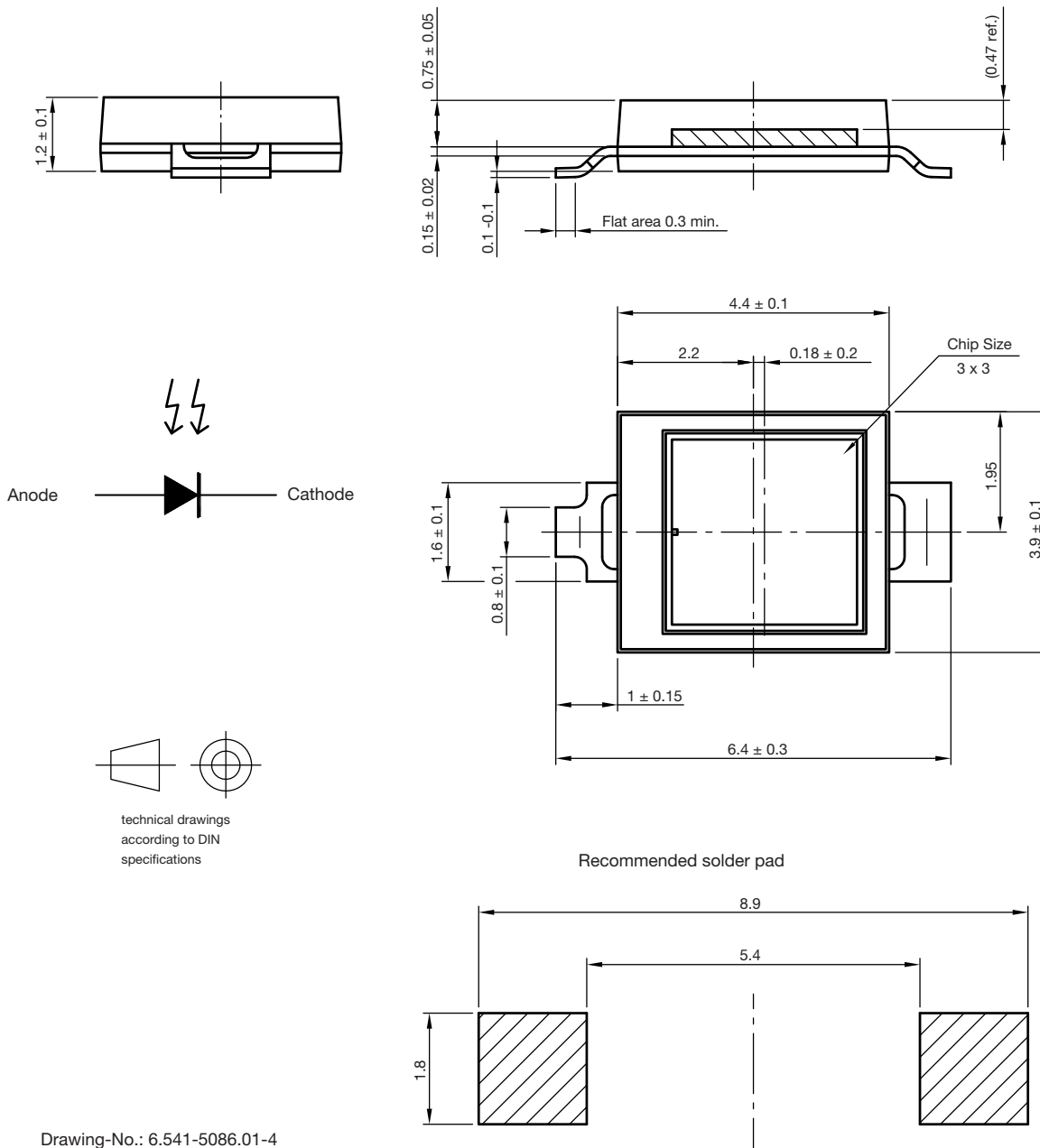


Fig. 5 - Diode Capacitance vs. Reverse Voltage



PACKAGE DIMENSIONS FOR VBPW34S in millimeters



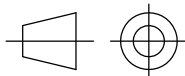
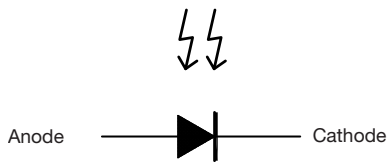
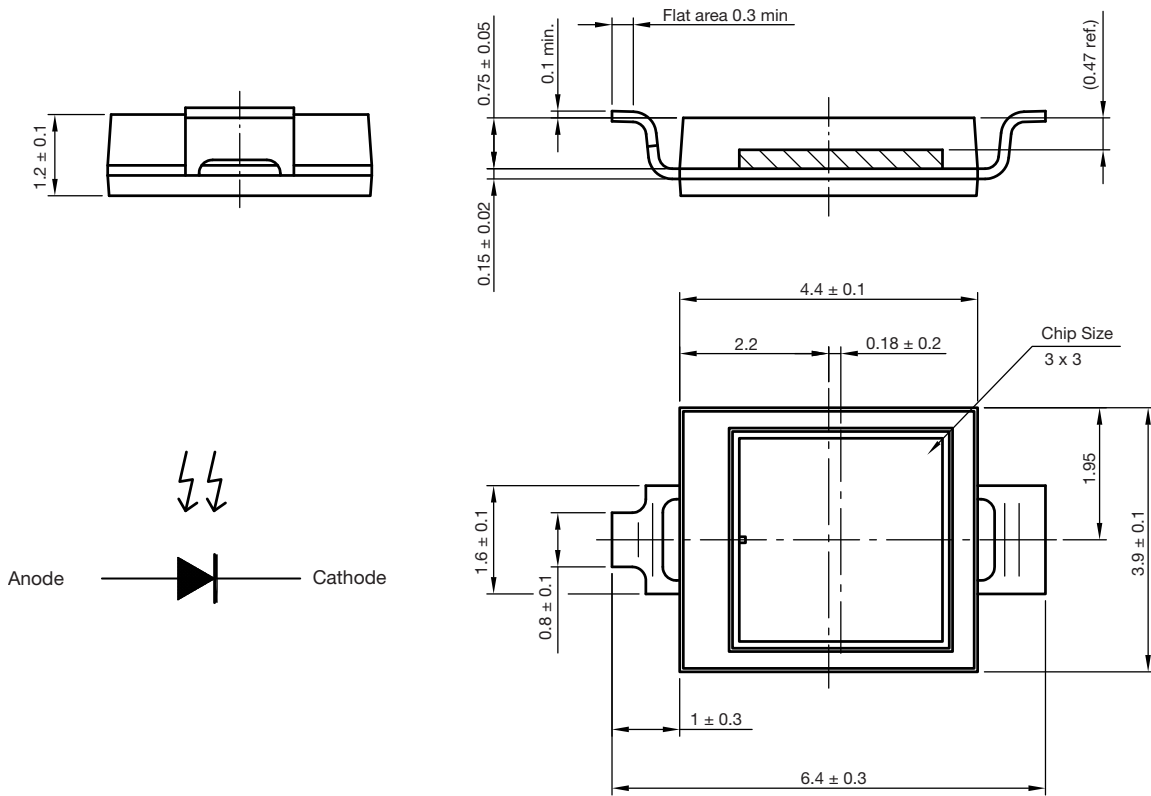
Drawing-No.: 6.541-5086.01-4

Issue: 1; 15.04.10

22105

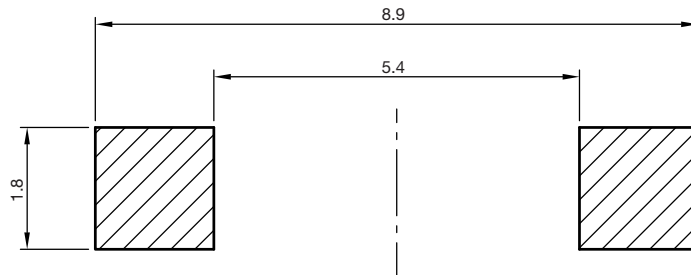


PACKAGE DIMENSIONS FOR VBPW34SR in millimeters



technical drawings according to DIN specifications

Recommended solder pad



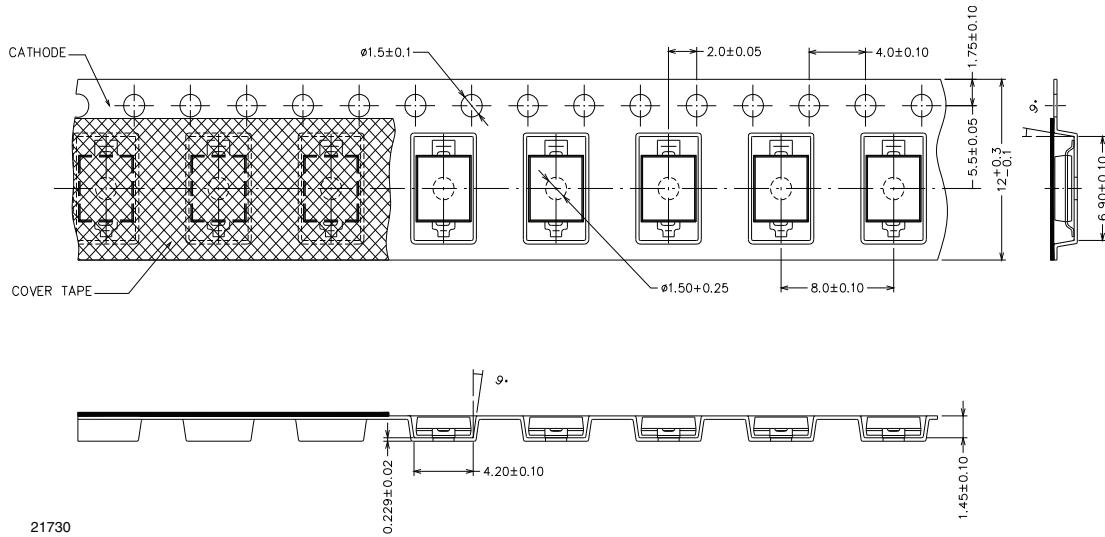
Drawing-No.: 6.541-5085.01-4

Issue: 1; 15.04.10

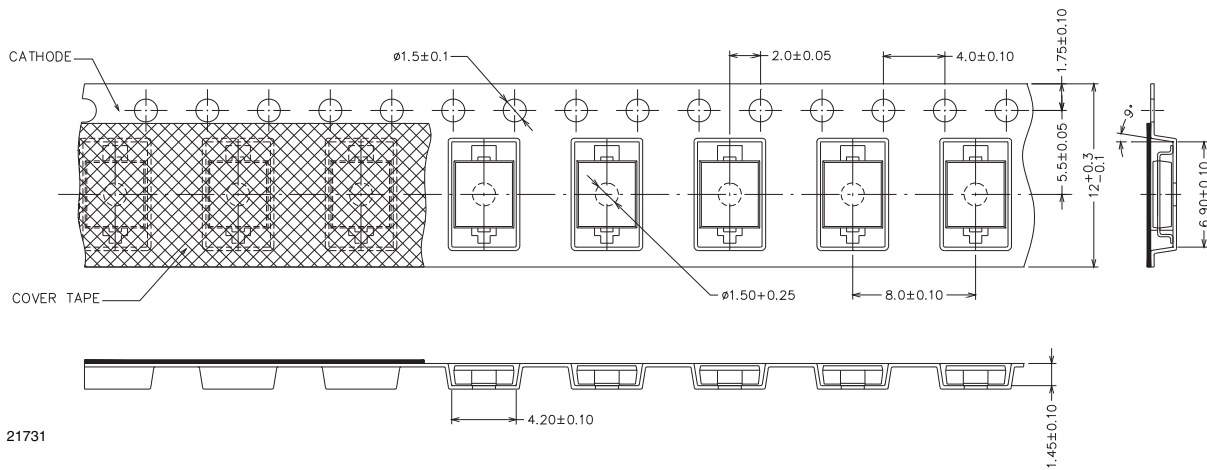
22104



TAPING DIMENSIONS FOR VBPW34S in millimeters



TAPING DIMENSIONS FOR VBPW34SR in millimeters

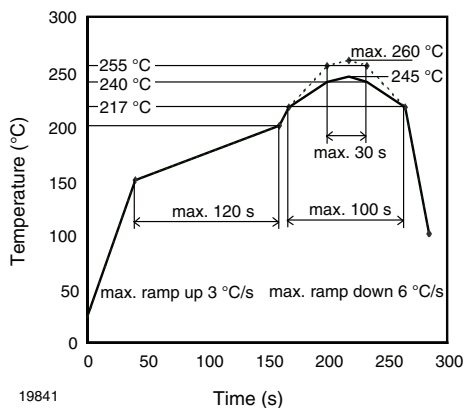


REEL DIMENSIONS FOR VBPW34S AND VBPW34SR in millimeters



21732

SOLDER PROFILE



19841

Fig. 8 - Lead (Pb)-free Reflow Solder Profile acc. J-STD-020

DRYPACK

Devices are packed in moisture barrier bags (MBB) to prevent the products from moisture absorption during transportation and storage. Each bag contains a desiccant.

FLOOR LIFE

Time between soldering and removing from MBB must not exceed the time indicated in J-STD-020:

Moisture sensitivity: level 3

Floor life: 168 h

Conditions: $T_{amb} < 30\text{ }^{\circ}\text{C}$, RH < 60 %

DRYING

In case of moisture absorption devices should be baked before soldering. Conditions see J-STD-020 or recommended conditions:

192 h at 40 °C (+ 5 °C), RH < 5 %

or

96 h at 60 °C (+ 5 °C), RH < 5 %.



Disclaimer

ALL PRODUCT, PRODUCT SPECIFICATIONS AND DATA ARE SUBJECT TO CHANGE WITHOUT NOTICE TO IMPROVE RELIABILITY, FUNCTION OR DESIGN OR OTHERWISE.

Vishay Intertechnology, Inc., its affiliates, agents, and employees, and all persons acting on its or their behalf (collectively, "Vishay"), disclaim any and all liability for any errors, inaccuracies or incompleteness contained in any datasheet or in any other disclosure relating to any product.

Vishay makes no warranty, representation or guarantee regarding the suitability of the products for any particular purpose or the continuing production of any product. To the maximum extent permitted by applicable law, Vishay disclaims (i) any and all liability arising out of the application or use of any product, (ii) any and all liability, including without limitation special, consequential or incidental damages, and (iii) any and all implied warranties, including warranties of fitness for particular purpose, non-infringement and merchantability.

Statements regarding the suitability of products for certain types of applications are based on Vishay's knowledge of typical requirements that are often placed on Vishay products in generic applications. Such statements are not binding statements about the suitability of products for a particular application. It is the customer's responsibility to validate that a particular product with the properties described in the product specification is suitable for use in a particular application. Parameters provided in datasheets and / or specifications may vary in different applications and performance may vary over time. All operating parameters, including typical parameters, must be validated for each customer application by the customer's technical experts. Product specifications do not expand or otherwise modify Vishay's terms and conditions of purchase, including but not limited to the warranty expressed therein.

Except as expressly indicated in writing, Vishay products are not designed for use in medical, life-saving, or life-sustaining applications or for any other application in which the failure of the Vishay product could result in personal injury or death. Customers using or selling Vishay products not expressly indicated for use in such applications do so at their own risk. Please contact authorized Vishay personnel to obtain written terms and conditions regarding products designed for such applications.

No license, express or implied, by estoppel or otherwise, to any intellectual property rights is granted by this document or by any conduct of Vishay. Product names and markings noted herein may be trademarks of their respective owners.