

Product Summary

V _{BR} Min	I _{PP} Max	C _T Typ
24V	130A	900pF

Description

This new generation TVS is designed to protect sensitive electronics from the damage due to ESD. The combination of small size and high ESD surge capability makes it ideal for use in portable applications such as cellular phones, digital cameras, and MP3 players.

Applications

- Cellular Handsets
- Portable Electronics
- Computers and Peripheral

Features

- Provides ESD Protection Per IEC 61000-4-2 Standard: Air ±30kV, Contact ±30kV
- One Channel of ESD Protection
- Low Channel Input Capacitance
- **Totally Lead-Free & Fully RoHS Compliant (Notes 1 & 2)**
- **Halogen and Antimony Free. "Green" Device (Note 3)**

Mechanical Data

- Case: U-DFN1820-6
- Case Material: Molded Plastic, "Green" Molding Compound. UL Flammability Classification Rating 94V-0
- Moisture Sensitivity: Level 1 per J-STD-020
- Terminals: NiPdAu over Copper Leadframe (Lead Free Plating). Solderable per MIL-STD-202, Method 208 **e4**
- Weight: 0.004 grams (Approximate)

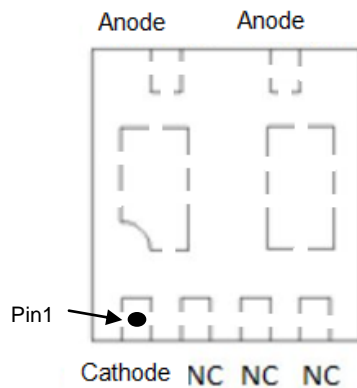

Top View

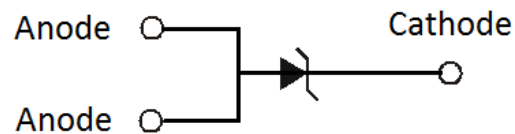

Device Schematic

The two anode pins should be electrically connected at the PCB.

Ordering Information (Note 4)

Part Number	Compliance	Marking	Reel Size (inches)	Tape Width (mm)	Quantity Per Reel
D22V0S1U6LP2018-7	Standard	PA3	7	8	3,000/Tape & Reel

- Notes:
1. No purposely added lead. Fully EU Directive 2002/95/EC (RoHS), 2011/65/EU (RoHS 2) & 2015/863/EU (RoHS 3) compliant.
 2. See <https://www.diodes.com/quality/lead-free/> for more information about Diodes Incorporated's definitions of Halogen- and Antimony-free, "Green" and Lead-free.
 3. Halogen- and Antimony-free "Green" products are defined as those which contain <900ppm bromine, <900ppm chlorine (<1500ppm total Br + Cl) and <1000ppm antimony compounds.
 4. For packaging details, go to our website at <https://www.diodes.com/design/support/packaging/diodes-packaging/>.

Marking Information

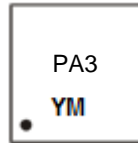

PA3 = Product Type Marking Code
 YM = Date Code Marking
 Y = Year (ex: F = 2018)
 M = Month (ex: 9 = September)

Date Code Key

Year	2018	2019	2020	2021	2022	2023
Code	F	G	H	I	J	K

Month	Jan	Feb	Mar	Apr	May	Jun	Jul	Aug	Sep	Oct	Nov	Dec
Code	1	2	3	4	5	6	7	8	9	O	N	D

Maximum Ratings (@T_A = +25°C, unless otherwise specified.)

Characteristic	Symbol	Value	Unit	Conditions
Peak Pulse Power Dissipation	P _{PP}	5460	W	8/20μs, Per Figure 2
Peak Pulse Current	I _{PP}	130	A	8/20μs, Per Figure 2
ESD Protection – Contact Discharge	V _{ESD_CONTACT}	±30	kV	Standard IEC 61000-4-2
ESD Protection – Air Discharge	V _{ESD_AIR}	±30	kV	Standard IEC 61000-4-2

Thermal Characteristics

Characteristic	Symbol	Value	Unit
Package Power Dissipation (Note 5)	P _D	900	mW
Thermal Resistance, Junction to Ambient (Note 5)	R _{θJA}	150	°C/W
Operating Temperature Range	T _J	-55 to +150	°C
Storage Temperature Range	T _{STG}	-65 to +150	°C

Electrical Characteristics (@T_A = +25°C, unless otherwise specified.)

Characteristic	Symbol	Min	Typ	Max	Unit	Test Conditions
Reverse Working Voltage	V _{RWM}	—	—	22	V	—
Reverse Current (Note 6)	I _R	—	—	1	μA	V _R = V _{RWM}
Reverse Breakdown Voltage	V _{BR}	24	—	27	V	I _R = 1mA
Reverse Clamping Voltage	V _{CL}	—	—	30	V	I _{PP} = 10A, t _P = 8/20μs
		—	—	32		I _{PP} = 50A, t _P = 8/20μs
		—	—	35		I _{PP} = 100A, t _P = 8/20μs
		—	—	42		I _{PP} = 130A, t _P = 8/20μs
Capacitance	C _T	—	900	—	pF	V _R = 0V, f = 1MHz

Notes: 5. Device mounted on FR-4 PCB pad layout (2oz copper) as shown on Diodes Incorporated's suggested pad layout, which can be found on our website at <http://www.diodes.com/package-outlines.html>.
 6. Short duration pulse test used to minimize self-heating effect.

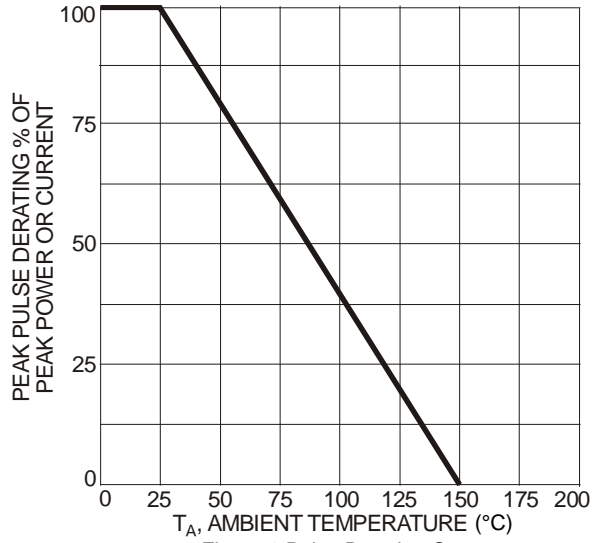

Figure 1 Pulse Derating Curve

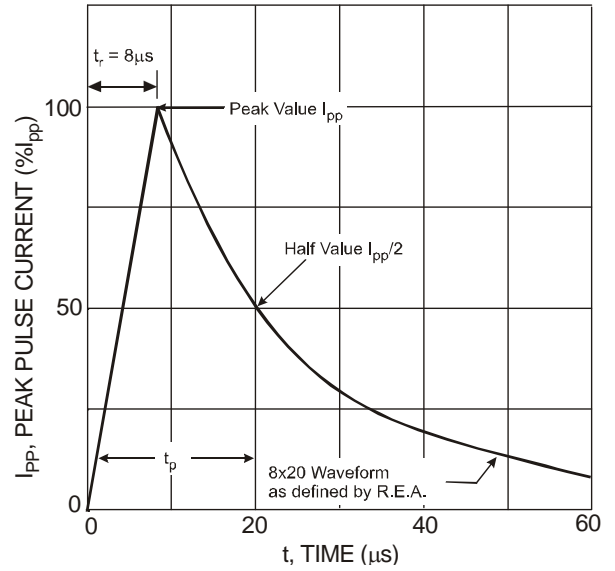

Figure 2 Typical 8 × 20µs Pulse Waveform

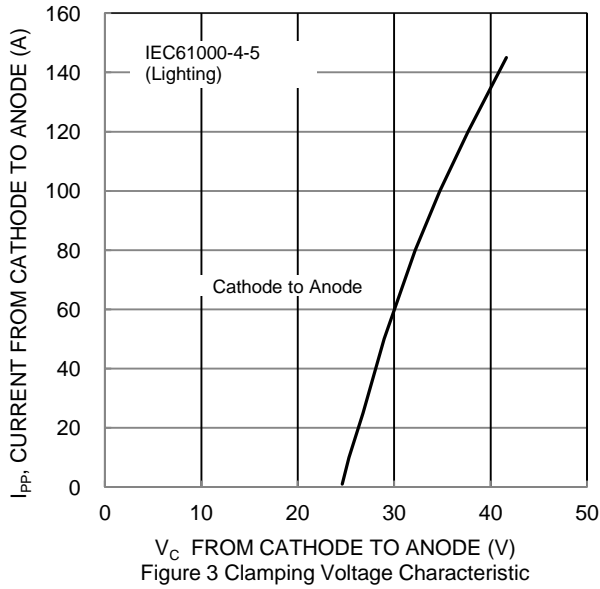

Figure 3 Clamping Voltage Characteristic

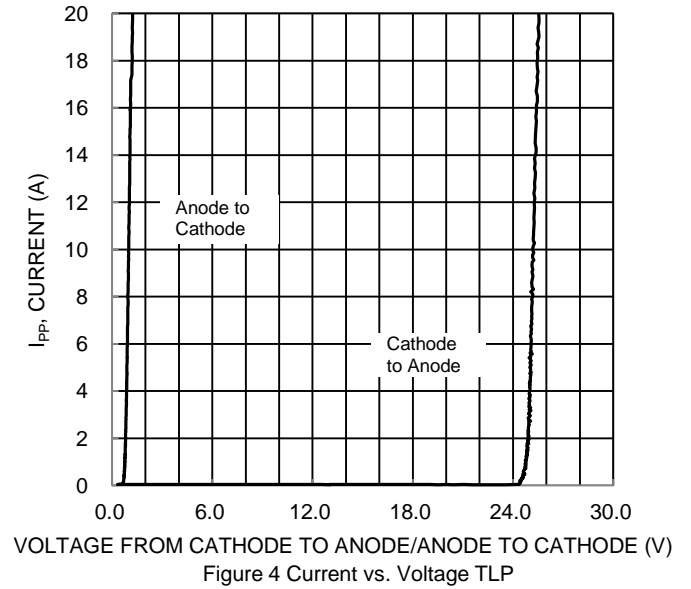
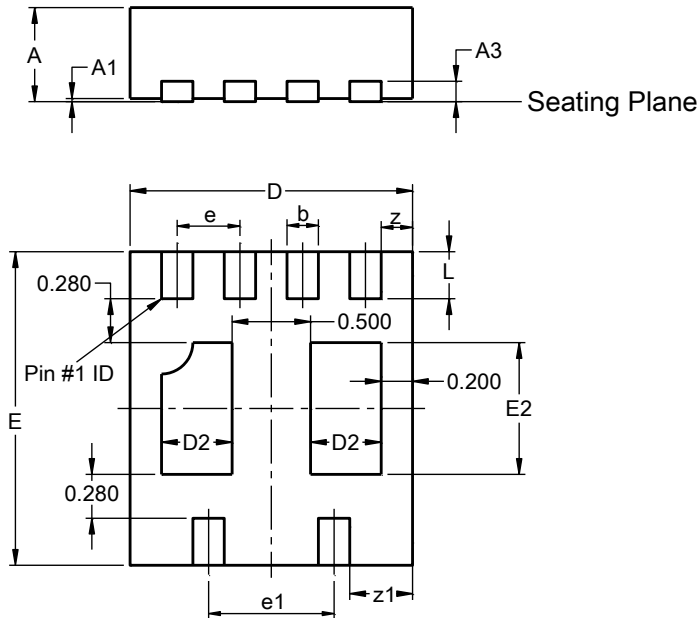

Figure 4 Current vs. Voltage TLP

Package Outline Dimensions

Please see <http://www.diodes.com/package-outlines.html> for the latest version.

U-DFN1820-6 (Type A)



U-DFN1820-6 (Type A)			
Dim	Min	Max	Typ
A	0.525	0.625	0.575
A1	0.00	0.05	0.02
A3	--	--	0.13
b	0.15	0.25	0.20
D	1.75	1.85	1.80
D2	0.35	0.55	0.45
E	1.95	2.05	2.00
E2	0.74	0.94	0.84
e	--	--	0.40
e1	--	--	0.80
L	0.25	0.35	0.30
z	--	--	0.20
z1	--	--	0.40
All Dimensions in mm			

Suggested Pad Layout

Please see <http://www.diodes.com/package-outlines.html> for the latest version.

U-DFN1820-6 (Type A)

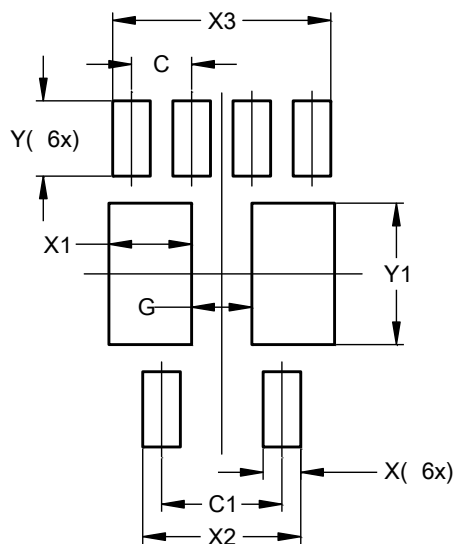

Dimensions	Value (in mm)
C	0.40
C1	0.80
G	0.40
X	0.25
X1	0.55
X2	1.05
X3	1.45
Y	0.50
Y1	0.94

IMPORTANT NOTICE

DIODES INCORPORATED MAKES NO WARRANTY OF ANY KIND, EXPRESS OR IMPLIED, WITH REGARDS TO THIS DOCUMENT, INCLUDING, BUT NOT LIMITED TO, THE IMPLIED WARRANTIES OF MERCHANTABILITY AND FITNESS FOR A PARTICULAR PURPOSE (AND THEIR EQUIVALENTS UNDER THE LAWS OF ANY JURISDICTION).

Diodes Incorporated and its subsidiaries reserve the right to make modifications, enhancements, improvements, corrections or other changes without further notice to this document and any product described herein. Diodes Incorporated does not assume any liability arising out of the application or use of this document or any product described herein; neither does Diodes Incorporated convey any license under its patent or trademark rights, nor the rights of others. Any Customer or user of this document or products described herein in such applications shall assume all risks of such use and will agree to hold Diodes Incorporated and all the companies whose products are represented on Diodes Incorporated website, harmless against all damages.

Diodes Incorporated does not warrant or accept any liability whatsoever in respect of any products purchased through unauthorized sales channel. Should Customers purchase or use Diodes Incorporated products for any unintended or unauthorized application, Customers shall indemnify and hold Diodes Incorporated and its representatives harmless against all claims, damages, expenses, and attorney fees arising out of, directly or indirectly, any claim of personal injury or death associated with such unintended or unauthorized application.

Products described herein may be covered by one or more United States, international or foreign patents pending. Product names and markings noted herein may also be covered by one or more United States, international or foreign trademarks.

This document is written in English but may be translated into multiple languages for reference. Only the English version of this document is the final and determinative format released by Diodes Incorporated.

LIFE SUPPORT

Diodes Incorporated products are specifically not authorized for use as critical components in life support devices or systems without the express written approval of the Chief Executive Officer of Diodes Incorporated. As used herein:

A. Life support devices or systems are devices or systems which:

1. are intended to implant into the body, or
2. support or sustain life and whose failure to perform when properly used in accordance with instructions for use provided in the labeling can be reasonably expected to result in significant injury to the user.

B. A critical component is any component in a life support device or system whose failure to perform can be reasonably expected to cause the failure of the life support device or to affect its safety or effectiveness.

Customers represent that they have all necessary expertise in the safety and regulatory ramifications of their life support devices or systems, and acknowledge and agree that they are solely responsible for all legal, regulatory and safety-related requirements concerning their products and any use of Diodes Incorporated products in such safety-critical, life support devices or systems, notwithstanding any devices- or systems-related information or support that may be provided by Diodes Incorporated. Further, Customers must fully indemnify Diodes Incorporated and its representatives against any damages arising out of the use of Diodes Incorporated products in such safety-critical, life support devices or systems.

Copyright © 2018, Diodes Incorporated

www.diodes.com

Mouser Electronics

Authorized Distributor

Click to View Pricing, Inventory, Delivery & Lifecycle Information:

[Diodes Incorporated:](#)

[D22V0S1U6LP2018-7](#)