

Specifications

Material

Plastic Housing: LCP, UL94V-0, Black
 Contact Terminal: Copper Alloy
 Metallic Shell: Stainless Steel T=0.25mm.

Plating

Contact Terminal:
 Contact Area: 30µ" Gold
 Solder Tails: Gold Flash
 Underplating: 50µ" Nickel
 Metallic Shell: Matte Tin over 50µ" Nickel

Electrical

Voltage Rating: 30 V AC
 Current Rating: Signal (Pins 2,3,4): 1.0 A.
 Power (Pins 1,5): 1.8A.
 Operating Temperature: -25°C to +85°C.
 Contact Resistance: 30mΩ max.
 Insulating Resistance: 1000MΩ min.
 Dielectric Withstand Voltage: 500V AC/minute

Mechanical & Environmental

Mating Force: 35N max.
 Unmating Force: Initial 10N min
 Final 8N min after durability test
 Durability: 10,000 Cycles

PCB Mount & Cap Information

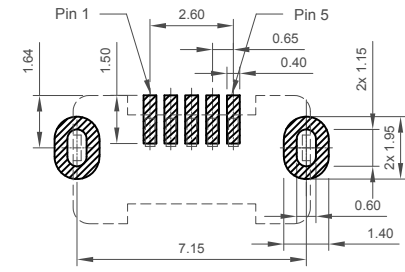
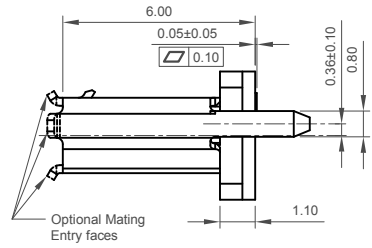
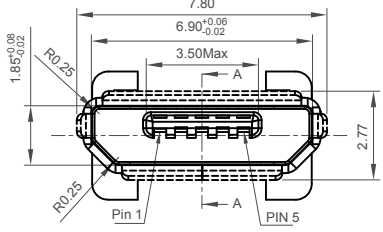
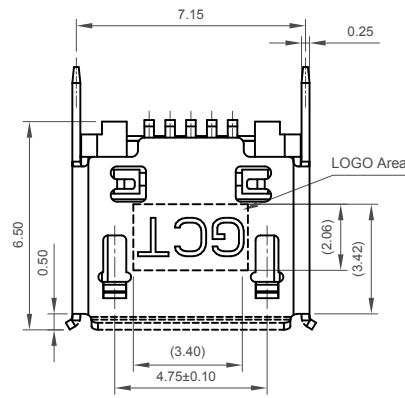
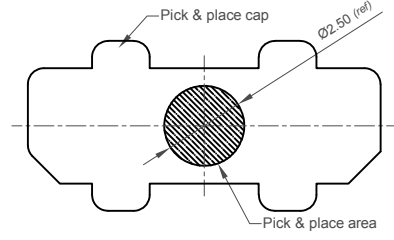
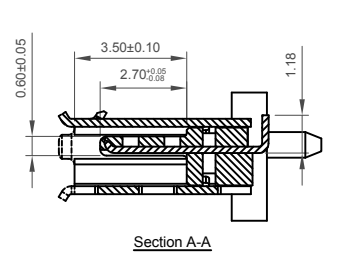

Recommended PCB Layout
 As viewed from component side General tolerance: ±0.05
 Solder Area Component Outline

Ordering Grid

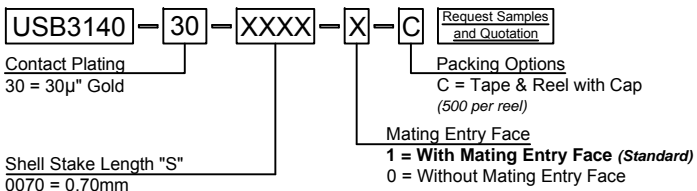

Shell Stake Length "S"
 0070 = 0.70mm
 0170 = 1.70mm (recommended for 1.00mm PCB)
 0230 = 2.30mm (recommended for 1.60mm PCB)

Designed to comply with physical, electrical and environmental requirements of Micro USB Standard (USB2.0)

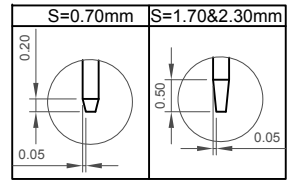

Detail A
 Scale 2:1

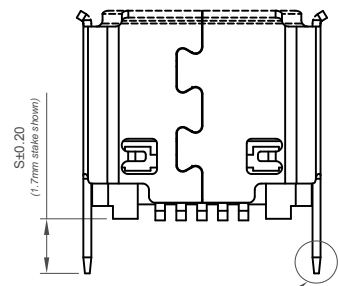

Part Number		Product Description	
USB3140		Micro USB Receptacle, Type B, Surface Mount, Vertical, with Through-Hole Shell Stakes	
Drawing Date		2nd April 2013	
By	CC	Tolerances (Except as Noted)	Units:
Detail	USB3140 E PCN	Length: X ±0.50	Metric (mm)
Revision	E2	Angle: X.X ± 0.30	3rd Angle Projection
Date	28/11/20	X.XX ± 0.20	
		X.XXX ± 0.10	



This drawing is confidential and copyright of Global Connector Technology, Ltd (GCT). This drawing must not be copied or disclosed without written consent. E & OE



Not to Scale	Drawn By AJO	Sheet No. 1/2
--------------	--------------	---------------

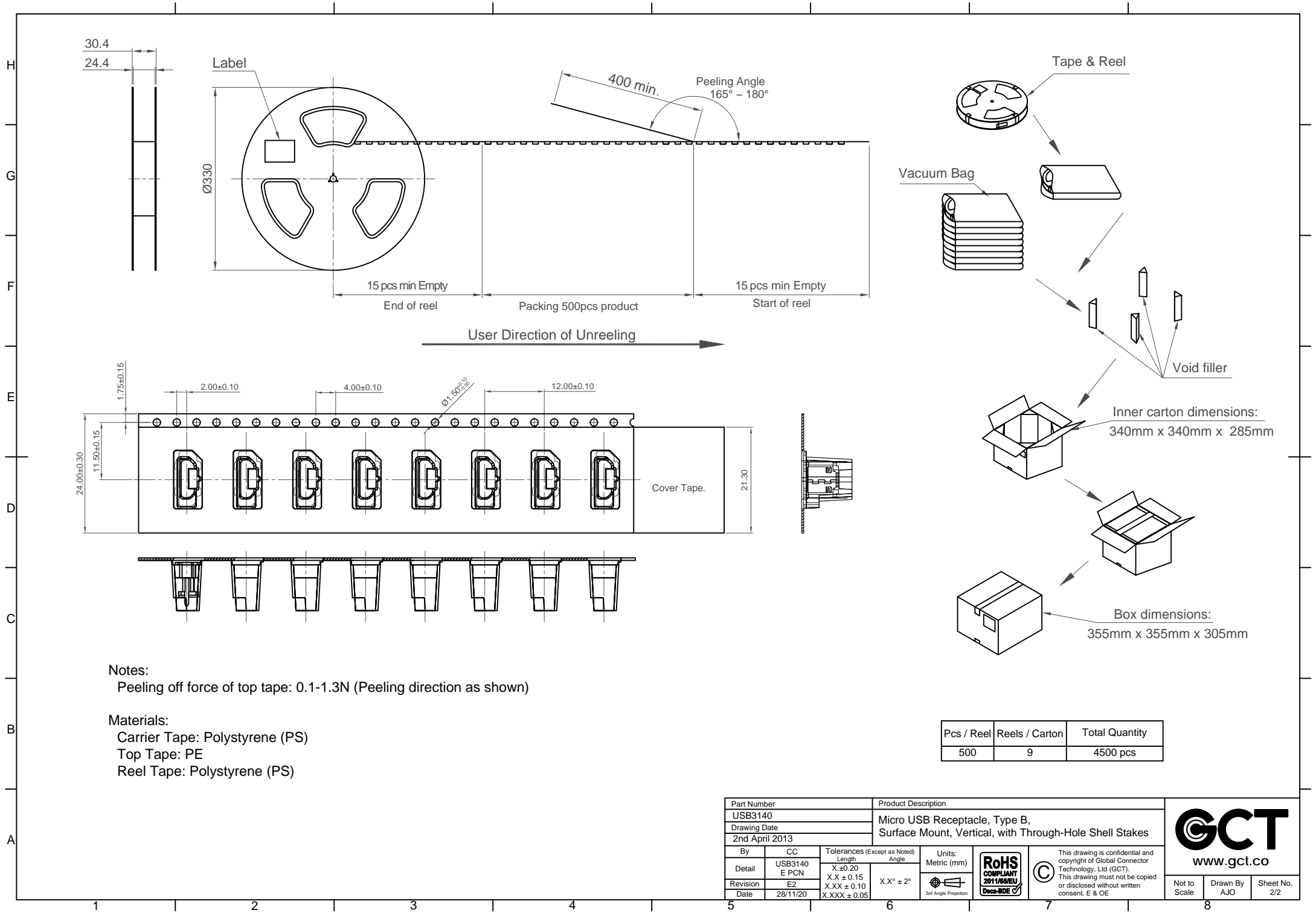

Notes:
 Peeling off force of top tape: 0.1-1.3N (Peeling direction as shown)

Materials:
 Carrier Tape: Polystyrene (PS)
 Top Tape: PE
 Reel Tape: Polystyrene (PS)

Pcs / Reel	Reels / Carton	Total Quantity
500	9	4500 pcs

Part Number		Product Description	
USB3140		Micro USB Receptacle, Type B, Surface Mount, Vertical, with Through-Hole Shell Stakes	
Drawing Date		2nd April 2013	
By	CC	Tolerances (Except as Noted)	Units:
Detail	USB3140 E PCN	Length X.±0.20 X.X ± 0.15 X.XX ± 0.10 X.XXX ± 0.05	Metric (mm)
Revision	E2	Angle X.X° ± 2°	3rd Angle Projection
Date	28/11/20		



This drawing is confidential and copyright of Global Connector Technology, Ltd (GCT). This drawing must not be copied or disclosed without written consent. E & OE



Not to Scale	Drawn By AJO	Sheet No. 2/2
--------------	--------------	---------------