

3 MHz, 2A Triple Synchronous Buck Regulator with HyperLight Load[®] and Power Good

Features

- 2.7V to 5.5V Input Voltage
- Three Independent 2A Outputs
- Up to 93% Peak Efficiency
- 81% Typical Efficiency at 1 mA
- Three Independent Power Good Indicators
- 24 μ A Typical Quiescent Current (per Channel)
- 3 MHz PWM Operation in Continuous Mode
- Ultra-Fast Transient Response
- Low Voltage Output Ripple
 - 30 mV_{PP} Ripple in HyperLight Load Mode
 - 5 mV Output Voltage Ripple in Full PWM Mode
- Fully Integrated MOSFET Switches
- 0.1 μ A Shutdown Current (per Channel)
- Thermal Shutdown and Current-Limit Protection
- Output Voltage as Low as 1V
- 26-Lead 4 mm x 4 mm FQFN
- -40°C to +125°C Junction Temperature Range

Applications

- Solid State Drives (SSD)
- μ C/ μ P, FPGA, and DSP Power
- Test and Measurement Systems
- Set-Top Boxes and DTV
- High-Performance Servers
- Security/Surveillance Cameras
- 5V POL Applications

General Description

The MIC23451 is a high-efficiency, 3 MHz, triple 2A, synchronous buck regulator with HyperLight Load[®] mode. HyperLight Load provides very high efficiency at light loads and ultra-fast transient response, which is ideal for supplying processor core voltages. An additional benefit of this proprietary architecture is very low output ripple voltage throughout the entire load range with the use of small output capacitors. The 4 mm x 4 mm FQFN package saves board space and requires only five external components for each channel.

The MIC23451 is designed for use with a very small inductor, down to 0.47 μ H, and an output capacitor as small as 2.2 μ F that enables a total solution size that is less than 1 mm height.

The MIC23451 has a very low quiescent current of 24 μ A each channel and achieves as high as 81% efficiency at 1 mA. At higher loads, the MIC23451 provides a constant switching frequency around 3 MHz while achieving peak efficiencies up to 93%.

The MIC23451 is available in a 26-lead 4 mm x 4 mm FQFN package with an operating junction temperature range from -40°C to +125°C.

Package Type

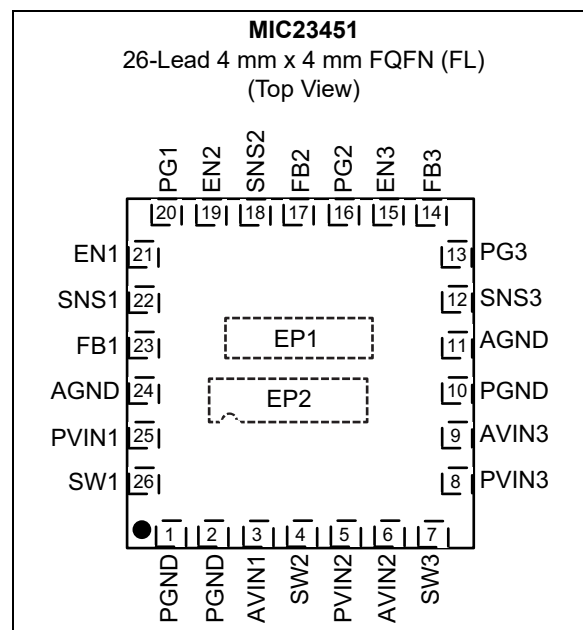

MIC23451

Typical Application Circuit

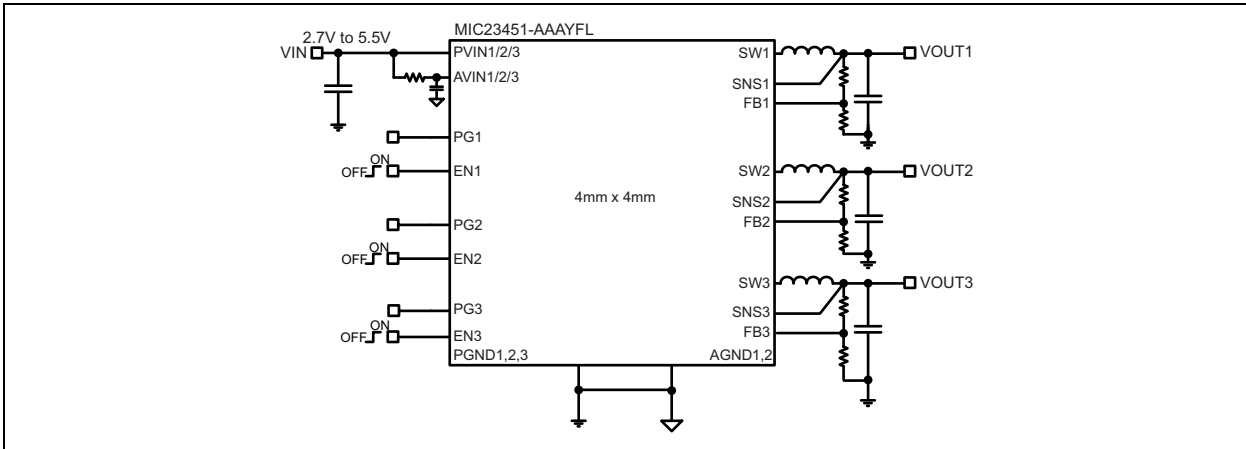

Functional Block Diagram

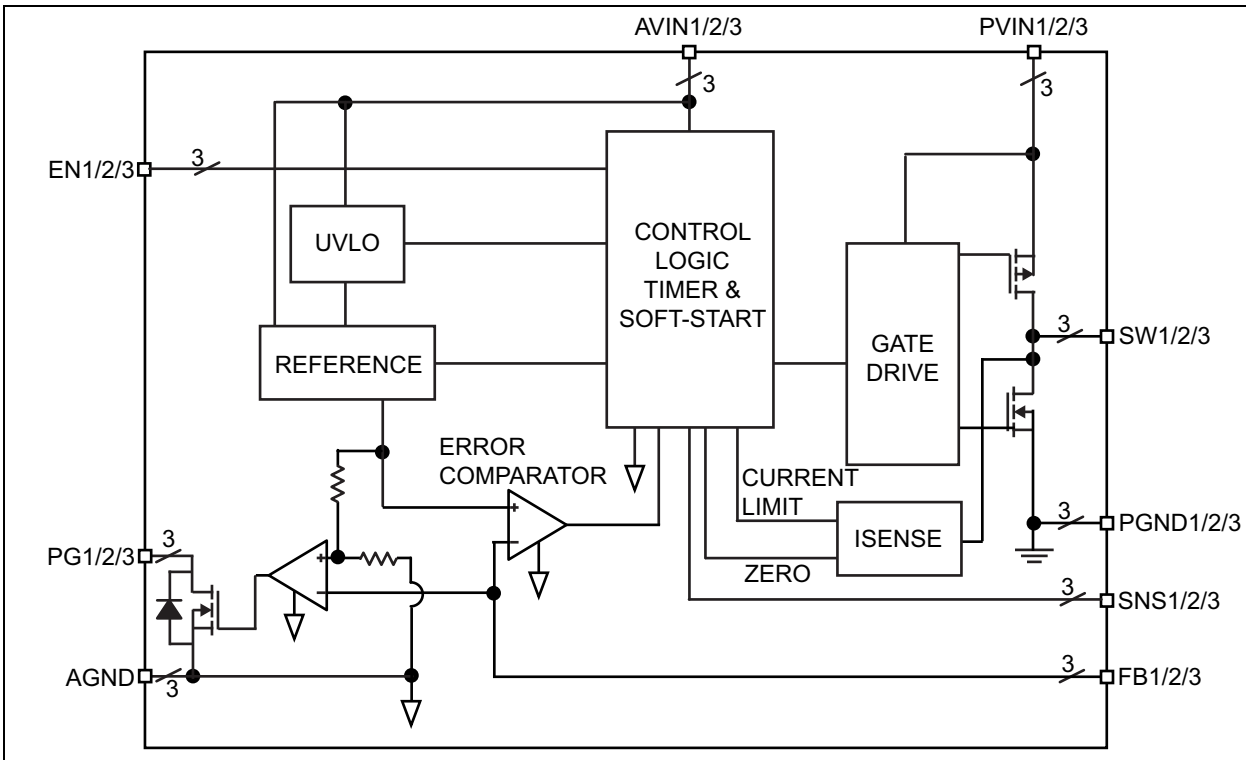

1.0 ELECTRICAL CHARACTERISTICS

Absolute Maximum Ratings †

Supply Voltage (PV_{IN} , AV_{IN})	-0.3V to +6V
Sense (V_{SNS1} , V_{SNS2} , V_{SNS3})	-0.3V to +6V
Power Good (PG1, PG2, PG3)	-0.3V to +6V
Output Switch Voltage (V_{SW1} , V_{SW2} , V_{SW3})	-0.3V to +6V
Enable Input Voltage (V_{EN1} , V_{EN2} , V_{EN3})	-0.3V to V_{IN}
ESD Rating	Note 1

Operating Ratings ‡

Supply Voltage (V_{IN})	+2.7V to +5.5V
Enable Input Voltage (V_{EN1} , V_{EN2} , V_{EN3})	0V to V_{IN}
Output Voltage Range (V_{SNS1} , V_{SNS2} , V_{SNS3})	+1V to +3.3V

† **Notice:** Stresses above those listed under “Absolute Maximum Ratings” may cause permanent damage to the device. This is a stress rating only and functional operation of the device at those or any other conditions above those indicated in the operational sections of this specification is not intended. Exposure to maximum rating conditions for extended periods may affect device reliability.

‡ **Notice:** The device is not guaranteed to function outside its operating ratings.

Note 1: Devices are ESD sensitive; use proper handling precautions. Human body model, 1.5 kΩ in series with 100 pF.

ELECTRICAL CHARACTERISTICS

Electrical Characteristics: $T_A = +25^\circ\text{C}$; $V_{IN} = V_{EN1} = V_{EN2} = V_{EN3} = 3.6\text{V}$; $L1 = L2 = L3 = 1\ \mu\text{H}$; $C_{OUT1} = C_{OUT2} = C_{OUT3} = 4.7\ \mu\text{F}$, unless otherwise specified. **Bold** values valid for $-40^\circ\text{C} \leq T_J \leq +125^\circ\text{C}$, unless noted. (Note 1)

Parameter	Symbol	Min.	Typ.	Max.	Units	Conditions
Supply Voltage Range	V_{IN}	2.7	—	5.5	V	—
Undervoltage Lockout Threshold	$UVLO_{TH}$	2.45	2.55	2.65	V	Turn-On
Undervoltage Lockout Hysteresis	$UVLO_{HYS}$	—	75	—	mV	—
Quiescent Current	I_Q	—	65	120	μA	$I_{OUT} = 0\ \text{mA}$, $V_{SNS} > 1.2 \times V_{OUT(NOM)}$
Per Channel Shutdown Current	I_{SHDN}	—	0.1	5	μA	$V_{EN1}, V_{EN2}, V_{EN3} = 0\text{V}$; $V_{IN} = 5.5\text{V}$
Output Voltage Accuracy	—	-2.5	—	+2.5	%	$V_{IN} = 3.6\text{V}$ if $V_{OUT(NOM)} < 2.5\text{V}$, $I_{LOAD} = 20\ \text{mA}$
		-2.5	—	+2.5		$V_{IN} = 4.5\text{V}$ if $V_{OUT(NOM)} \geq 2.5\text{V}$, $I_{LOAD} = 20\ \text{mA}$
Feedback Voltage	V_{FBx}	0.604	0.62	0.635	V	—
Peak Current Limit	$I_{LIM(PK)}$	2.2	4.1	—	A	$SNS1, SNS2, SNS3 = 0.9 \times V_{OUT(NOM)}$
Foldback Current Limit	I_{LIM}	—	2.3	—	A	—
Output Voltage Line Regulation (V_{OUT1} , V_{OUT2} , V_{OUT3})	—	—	0.3	—	%/ V	$V_{IN} = 3.6\text{V}$ to 5.5V if $V_{OUT(NOM)1,2,3} < 2.5\text{V}$, $I_{LOAD} = 20\ \text{mA}$
		—	0.3	—		$V_{IN} = 4.5\text{V}$ to 5.5V if $V_{OUT(NOM)1,2,3} \geq 2.5\text{V}$, $I_{LOAD} = 20\ \text{mA}$

MIC23451

ELECTRICAL CHARACTERISTICS (CONTINUED)

Electrical Characteristics: $T_A = +25^\circ\text{C}$; $V_{IN} = V_{EN1} = V_{EN2} = V_{EN3} = 3.6\text{V}$; $L1 = L2 = L3 = 1\ \mu\text{H}$; $C_{OUT1} = C_{OUT2} = C_{OUT3} = 4.7\ \mu\text{F}$, unless otherwise specified. **Bold** values valid for $-40^\circ\text{C} \leq T_J \leq +125^\circ\text{C}$, unless noted. ([Note 1](#))

Parameter	Symbol	Min.	Typ.	Max.	Units	Conditions
Output Voltage Load Regulation (V_{OUT1} , V_{OUT2} , V_{OUT3})	—	—	0.2	—	%	DCM: $20\ \text{mA} < I_{LOAD} < 130\ \text{mA}$, $V_{IN} = 3.6\text{V}$ if $V_{OUT(NOM)} < 2.5\text{V}$
		—	0.4	—		DCM: $20\ \text{mA} < I_{LOAD} < 130\ \text{mA}$, $V_{IN} = 5.0\text{V}$ if $V_{OUT(NOM)} > 2.5\text{V}$
		—	0.6	—		CCM: $200\ \text{mA} < I_{LOAD} < 500\ \text{mA}$, $V_{IN} = 3.6\text{V}$ if $V_{OUT(NOM)} < 2.5\text{V}$
		—	0.3	—		CCM: $200\ \text{mA} < I_{LOAD} < 1\text{A}$, $V_{IN} = 5.0\text{V}$ if $V_{OUT(NOM)} > 2.5\text{V}$
PWM Switch ON-Resistance (R_{SW1} , R_{SW2} , R_{SW3})	$R_{DS(ON)}$	—	0.217	—	Ω	$I_{SW1}, I_{SW2}, I_{SW3} = +100\ \text{mA}$ (PMOS)
Maximum Frequency	f_{MAX}	—	—	3	MHz	$I_{OUT1}, I_{OUT2}, I_{OUT3} = 120\ \text{mA}$
Soft-Start Time	t_{SS}	—	150	—	μs	$V_{OUT1}, V_{OUT2}, V_{OUT3} = 90\%$
Power Good Threshold	PG_{TH}	83	90	96	%	% of V_{NOM}
Power Good Hysteresis	PG_{HYS}	—	10	—	%	—
Power Good Pull-Down	PG_{PD}	—	—	200	mV	$V_{SNS} = 90\% V_{NOM}$, $I_{PG} = 1\ \text{mA}$
Enable Threshold	V_{EN}	0.5	0.9	1.2	V	Turn-On
Enable Input Current	I_{EN}	—	0.1	1	μA	—
Overtemperature Shutdown	T_{SHDN}	—	160	—	$^\circ\text{C}$	—
Overtemperature Shutdown Hysteresis	$T_{SHDN(HYS)}$	—	20	—	$^\circ\text{C}$	—

Note 1: Specifications are for packaged products only.

TEMPERATURE SPECIFICATIONS

Parameters	Sym.	Min.	Typ.	Max.	Units	Conditions
Temperature Ranges						
Junction Temperature Range	T_J	-40	—	+125	$^\circ\text{C}$	Note 1
Storage Temperature Range	T_S	-65	—	+150	$^\circ\text{C}$	—
Package Thermal Resistances						
Thermal Resistance, FQFN 26-Ld	θ_{JA}	—	20	—	$^\circ\text{C/W}$	—
	θ_{JC}	—	10	—	$^\circ\text{C/W}$	—

Note 1: The maximum allowable power dissipation is a function of ambient temperature, the maximum allowable junction temperature and the thermal resistance from junction to air (i.e., T_A , T_J , θ_{JA}). Exceeding the maximum allowable power dissipation will cause the device operating junction temperature to exceed the maximum +125 $^\circ\text{C}$ rating. Sustained junction temperatures above +125 $^\circ\text{C}$ can impact the device reliability.

2.0 TYPICAL PERFORMANCE CURVES

Note: The graphs and tables provided following this note are a statistical summary based on a limited number of samples and are provided for informational purposes only. The performance characteristics listed herein are not tested or guaranteed. In some graphs or tables, the data presented may be outside the specified operating range (e.g., outside specified power supply range) and therefore outside the warranted range.

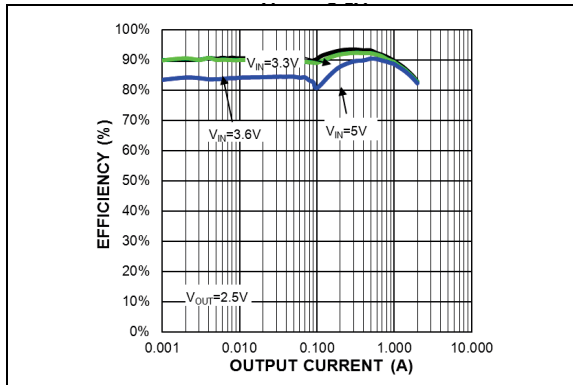

FIGURE 2-1: Efficiency vs. Output Current, $V_{OUT} = 2.5V$.

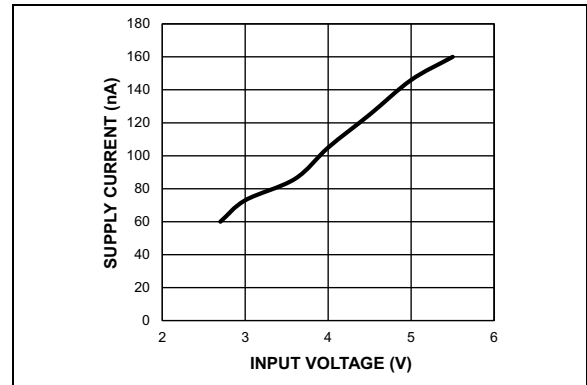

FIGURE 2-4: Shutdown Current vs. Input Voltage.

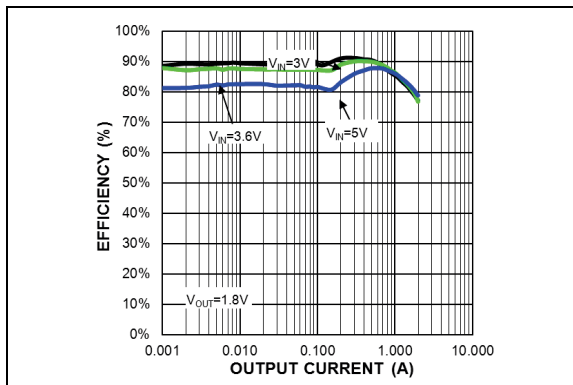

FIGURE 2-2: Efficiency vs. Output Current, $V_{OUT} = 1.8V$.

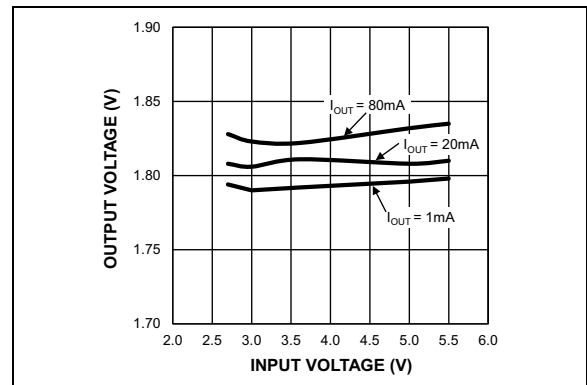

FIGURE 2-5: Line Regulation (Low Loads).

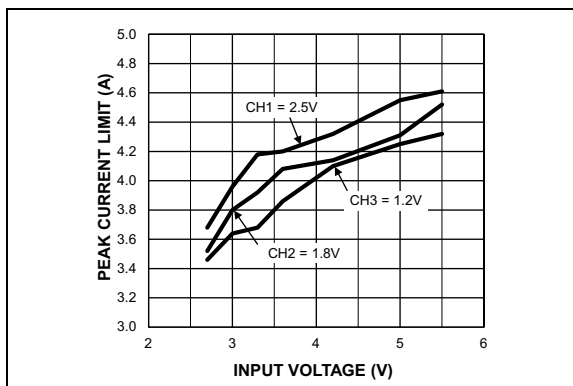

FIGURE 2-3: Current Limit vs. Input Voltage.

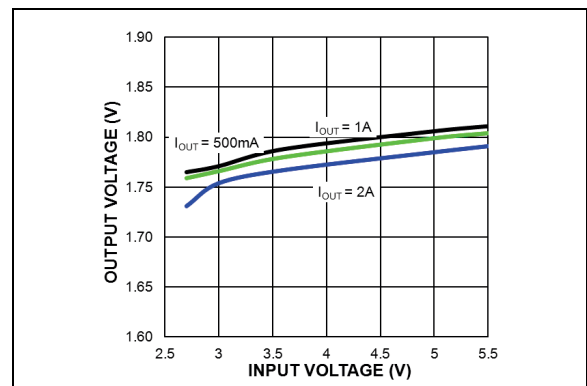

FIGURE 2-6: Line Regulation (High Loads).

MIC23451

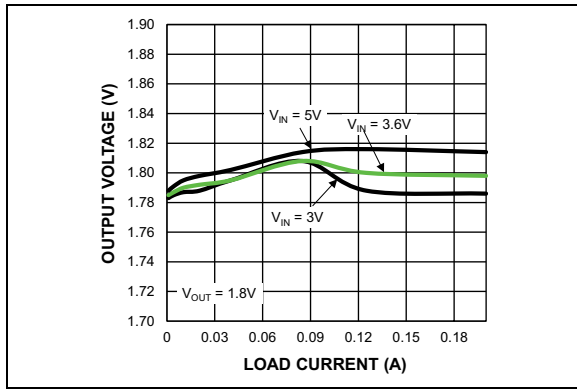

FIGURE 2-7: Output Voltage vs. Output Current (HLL).

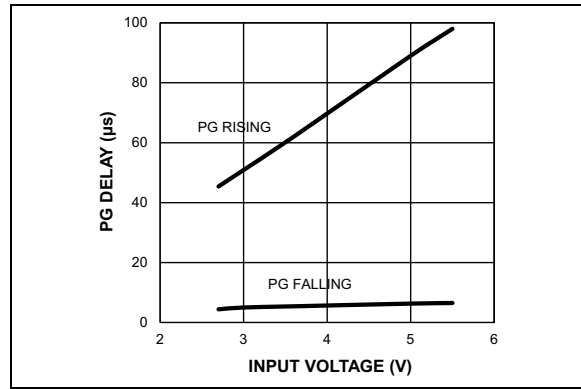

FIGURE 2-10: Power Good Delay Time vs. Input Voltage.

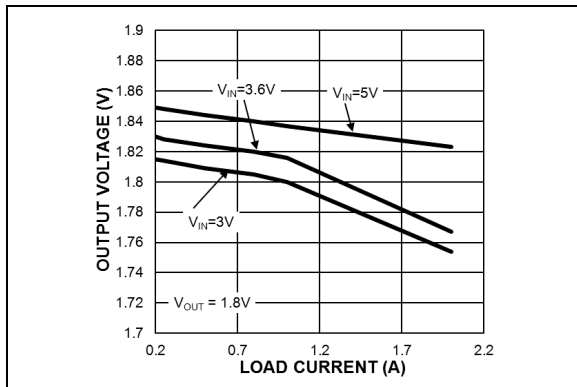

FIGURE 2-8: Output Voltage vs. Output Current (CCM).

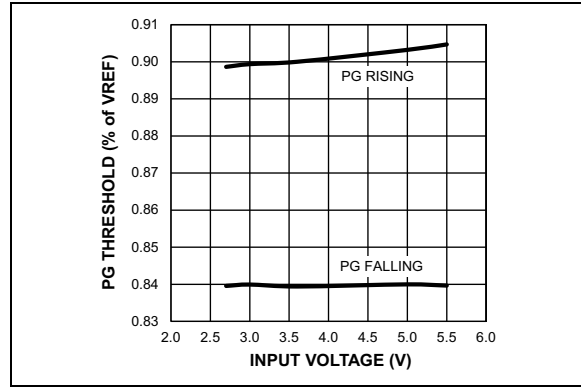

FIGURE 2-11: Power Good Thresholds vs. Input Voltage.

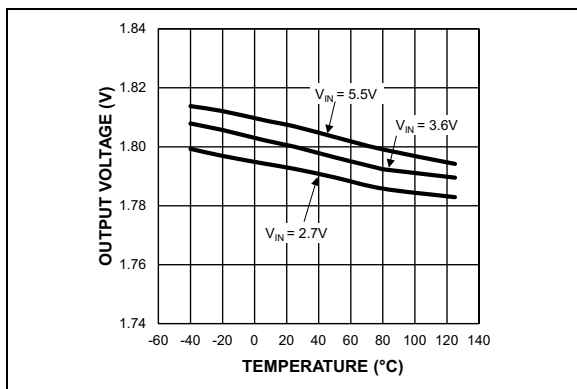

FIGURE 2-9: Output Voltage vs. Temperature.

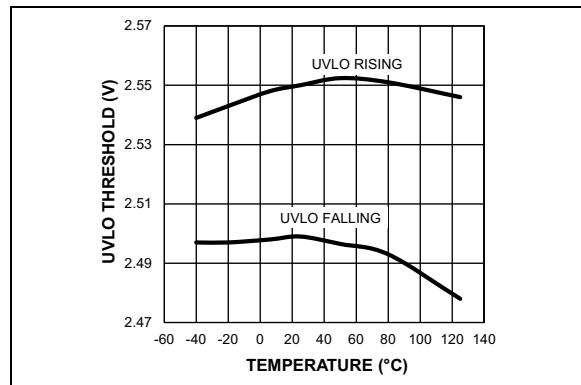

FIGURE 2-12: UVLO Threshold vs. Temperature.

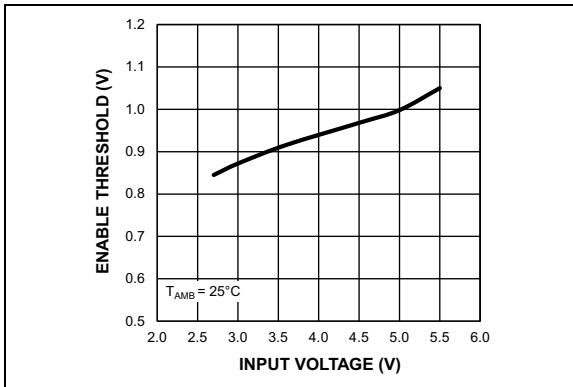

FIGURE 2-13: Enable Threshold vs. Input Voltage.

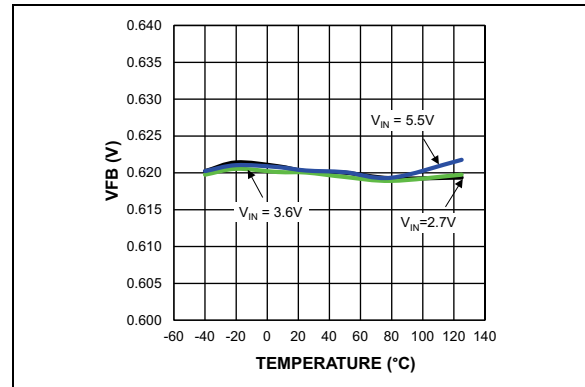

FIGURE 2-16: Feedback Voltage vs. Temperature.

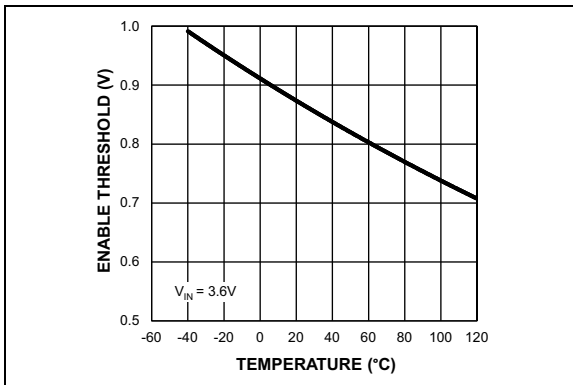

FIGURE 2-14: Enable Threshold vs. Temperature.

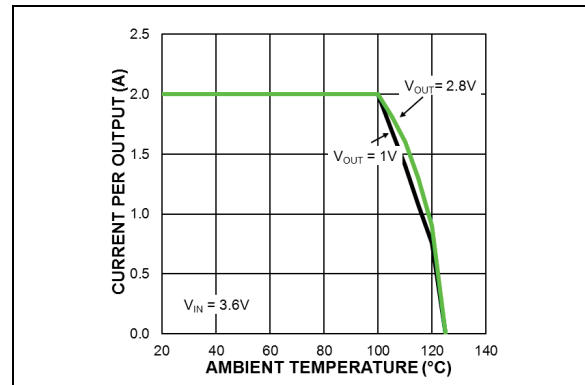

FIGURE 2-17: Maximum Output Current per O/P vs. Temperature (1 O/P).

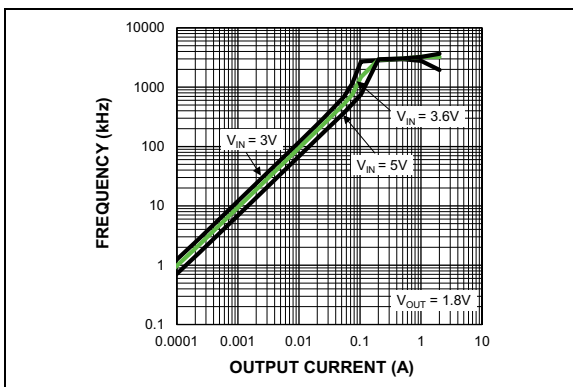

FIGURE 2-15: Switching Frequency vs. Load Current.

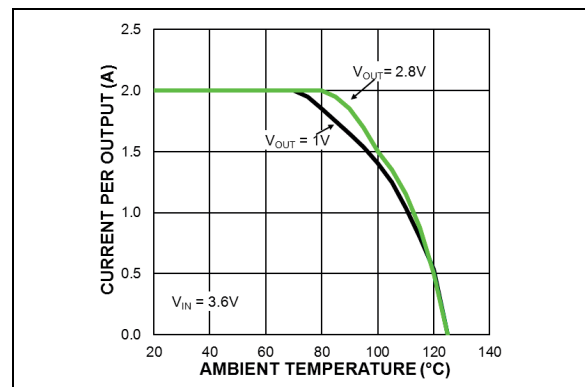

FIGURE 2-18: Maximum Output Current per O/P vs. Temperature (2 O/Ps).

MIC23451

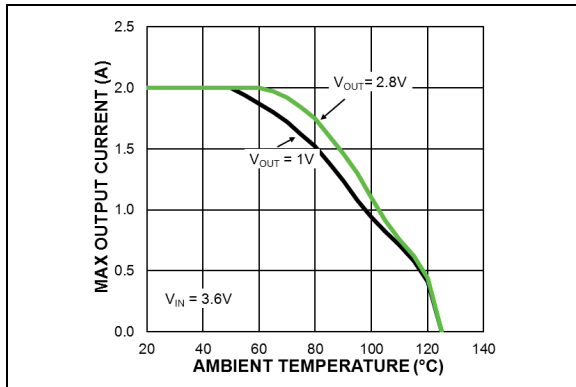

FIGURE 2-19: Maximum Output Current per O/P vs. Temperature (3 O/Ps).

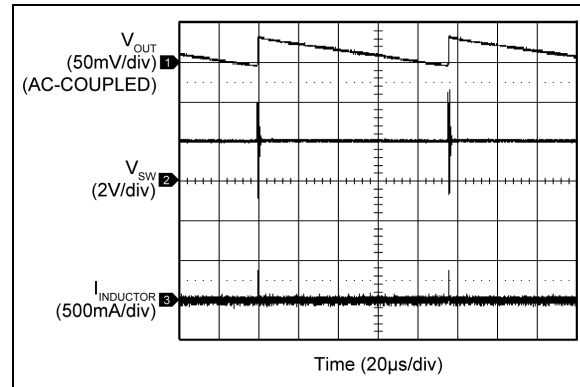

FIGURE 2-22: Switching Waveform Discontinuous Mode (1 mA).

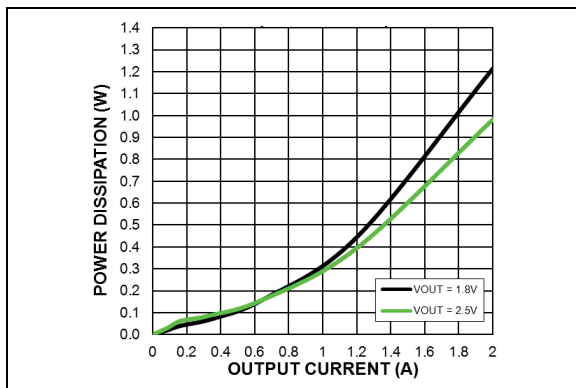

FIGURE 2-20: Power Dissipation vs. Load Current (per Channel).

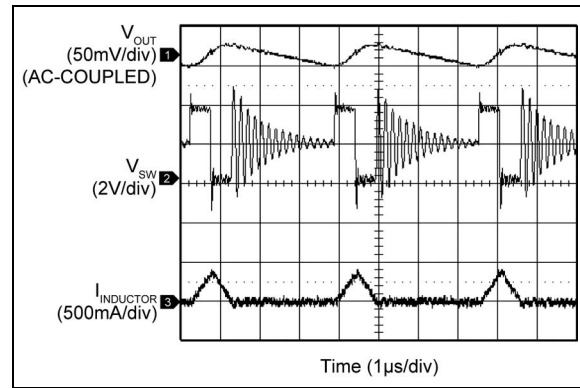

FIGURE 2-23: Switching Waveform Discontinuous Mode (50 mA).

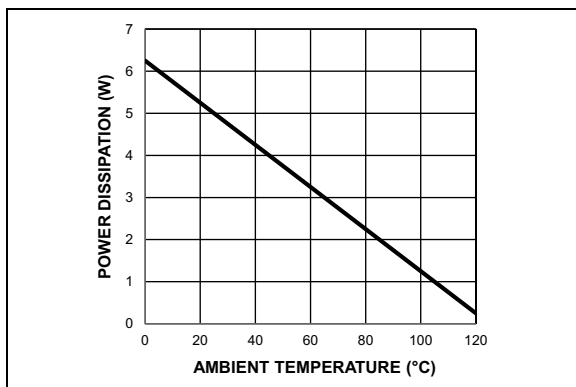

FIGURE 2-21: Maximum Package Dissipation vs. Ambient Temperature.

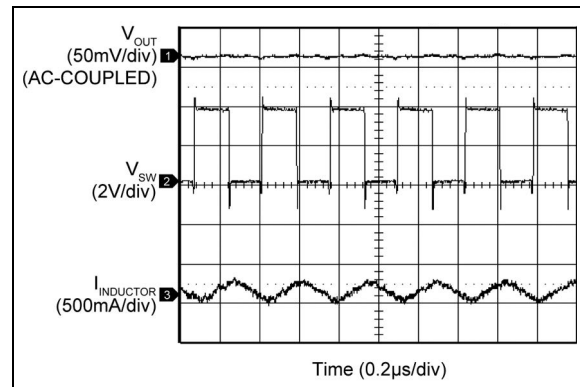

FIGURE 2-24: Switching Waveform Continuous Mode (150 mA).

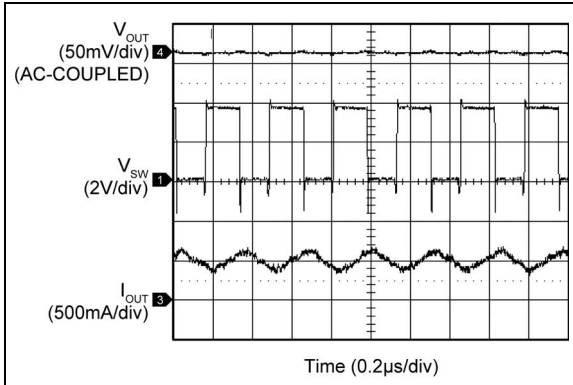

FIGURE 2-25: Switching Waveform Continuous Mode (500 mA).

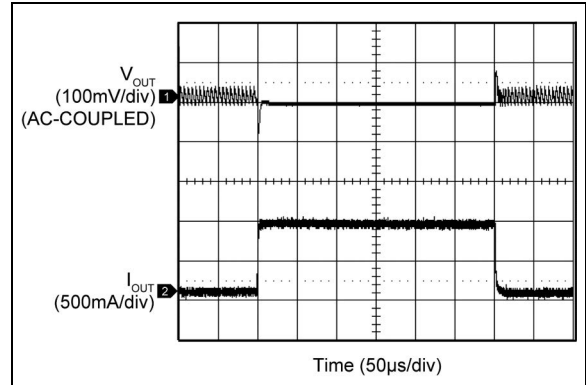

FIGURE 2-28: Load Transient (50 mA to 1A).

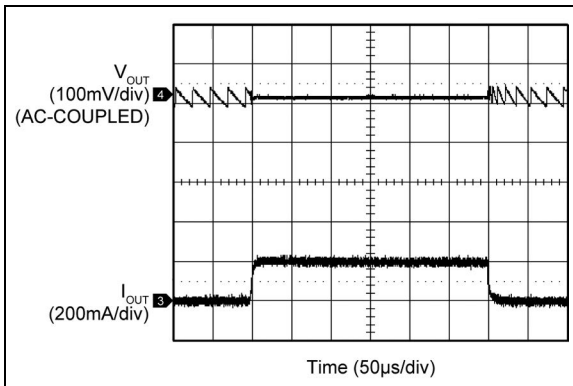

FIGURE 2-26: Load Transient (10 mA to 200 mA).

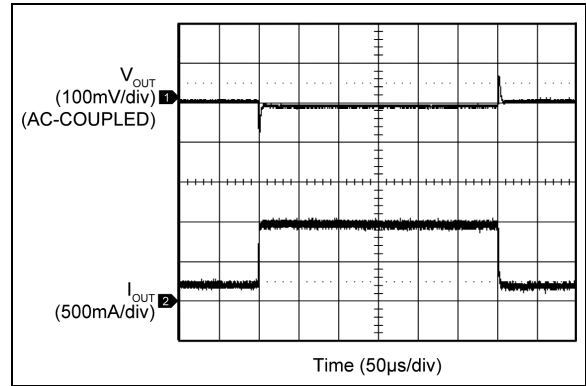

FIGURE 2-29: Load Transient (200 mA to 1A).

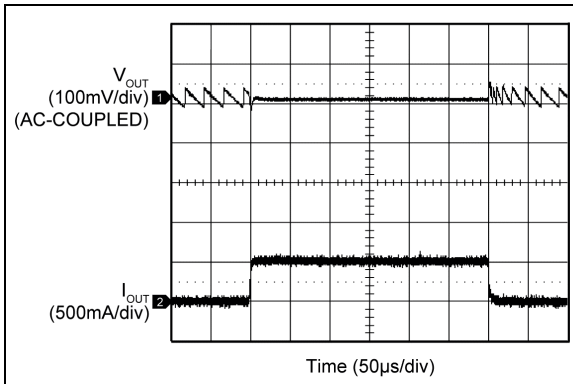

FIGURE 2-27: Load Transient (10 mA to 500 mA).

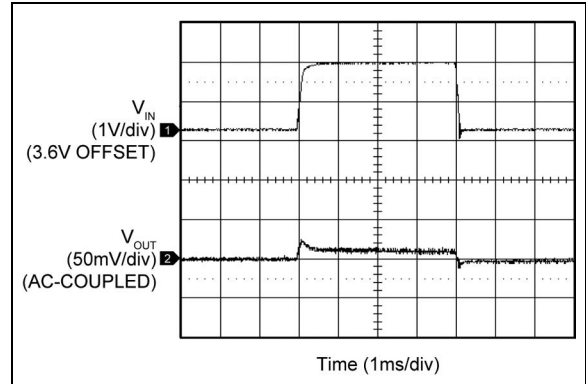

FIGURE 2-30: Line Transient (3.6V to 5.5V at 1A Load).

MIC23451

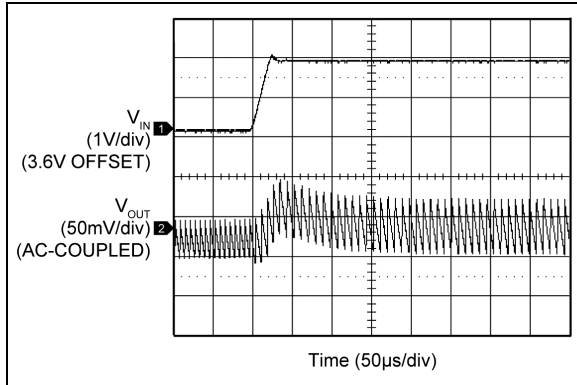

FIGURE 2-31: Line Transient (3.6V to 5.5V at 20 mA Load).

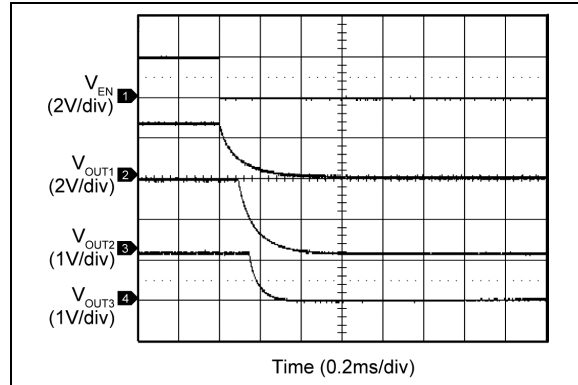

FIGURE 2-34: Shutdown and Power Good Waveform – Sequenced ($EN = EN1$, $PG1 = EN2$, $PG2 = EN3$).

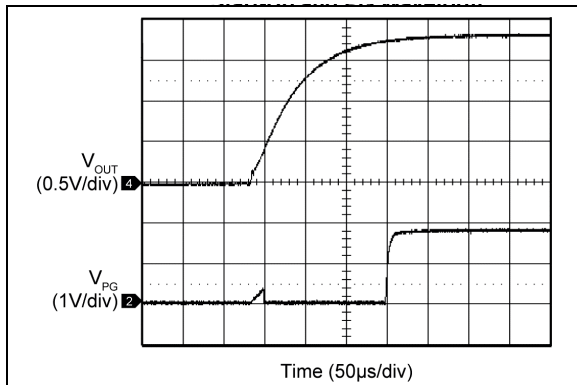

FIGURE 2-32: Start-Up and Power Good Waveform.

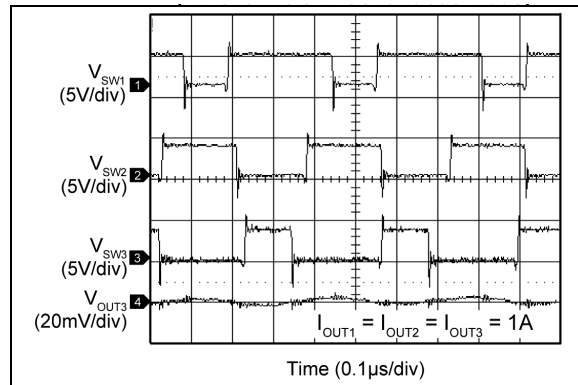

FIGURE 2-35: Switching Waveform (All Channels in Continuous Mode).

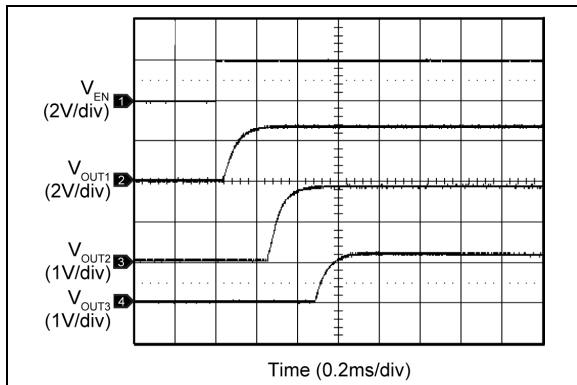

FIGURE 2-33: Start-Up and Power Good Waveform – Sequenced ($EN = EN1$, $PG1 = EN2$, $PG2 = EN3$).

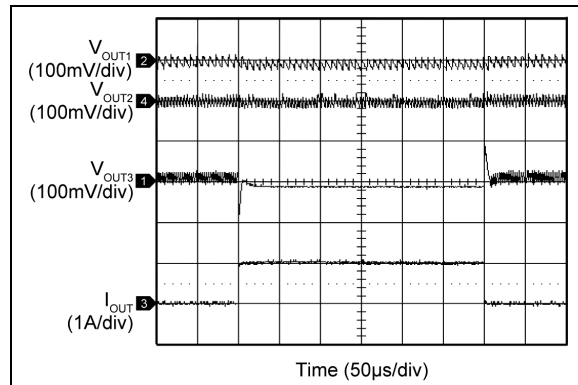

FIGURE 2-36: Transient Cross Regulation ($I_{OUT3} = 20\text{ mA to }1A$; $I_{OUT1}, I_{OUT2} = 20\text{ mA}$).

3.0 PIN DESCRIPTIONS

The descriptions of the pins are listed in [Table 3-1](#).

TABLE 3-1: PIN FUNCTION TABLE

Pin Number	Pin Name	Description
26, 4, 7	SW1, 2, 3	Switch (Output). Internal power MOSFET output switches for output 1/2/3.
21, 19, 15	EN1, 2, 3	Enable (Input). Logic high enables operation of regulator 1/2/3. Logic low will shut down the device. Do not leave floating.
22, 18, 12	SNS1, 2, 3	Sense. Connect to $V_{OUT1,2,3}$ as close to output capacitor as possible to sense output voltage.
23, 17, 14	FB1, 2, 3	Feedback. Connect a resistor divider from output 1/2/3 to ground to set the output voltage.
20, 16, 13	PG1, 2, 3	Power Good. Open-drain output for the power good indicator for output 1/2/3. Place a resistor between this pin and a voltage source to detect a power good condition.
EP1, 24, 11	AGND	Analog Ground. Connect to quiet ground point away from high-current paths, for example, C_{OUT} , for best operation. Must be connected externally to PGND.
25, 5, 8	PVIN1, 2, 3	Power Input Voltage. Connect a capacitor to PGND to localize loop currents and decouple switching noise.
3, 6, 9	AVIN1, 2, 3	Analog Input Voltage. Connect a capacitor to AGND to decouple noise.
EP2, 10, 2, 1	PGND	Power Ground.

MIC23451

4.0 FUNCTIONAL DESCRIPTION

4.1 PVIN

The input supply (PVIN) provides power to the internal MOSFETs for the switch mode regulator. The V_{IN} operating range is 2.7V to 5.5V, so an input capacitor, with a minimum voltage rating of 6.3V is recommended. Because of the high di/dt switching speeds, a minimum 2.2 μ F or 4.7 μ F recommended bypass capacitor, placed close to PVIN and the power ground (PGND) pin, is required. Refer to the [PCB Layout Recommendations](#) section for details.

4.2 AVIN

The input supply (AVIN) provides power to the internal control circuitry. Because the high di/dt switching speeds on PVIN cause small voltage spikes, a 50 Ω RC filter and a minimum 100 nF decoupling capacitor, placed close to the AVIN and signal ground (AGND) pin, is required.

4.3 EN

A logic high signal on the enable pin (EN) activates the output voltage of the device. A logic low signal on the enable pin deactivates the output and reduces supply current to 0.01 μ A. The MIC23451 features internal soft-start circuitry that reduces inrush current and prevents the output voltage from overshooting at start-up. Do not leave the EN pin floating.

4.4 SW

The switch (SW) connects directly to one end of the inductor and provides the current path during switching cycles. The other end of the inductor is connected to the load, SNS pin, and output capacitor. Because of the high-speed switching on this pin, the switch node should be routed away from sensitive nodes.

4.5 SNS

The sense (SNS) pin is connected to the output of the device to provide feedback to the control circuitry. The SNS connection should be placed close to the output capacitor. Refer to the [PCB Layout Recommendations](#) section for more details.

4.6 AGND

The analog ground (AGND) is the ground path for the biasing and control circuitry. The current loop for the signal ground should be separate from the power ground (PGND) loop. Refer to the [PCB Layout Recommendations](#) section for more details.

4.7 PGND

The power ground pin is the ground path for the high current in PWM mode. The current loop for the power ground should be as short and wide as possible and separate from the analog ground (AGND) loop as applicable. Refer to the [PCB Layout Recommendations](#) section for more details.

4.8 PG

The power good (PG) pin is an open-drain output that indicates logic high when the output voltage is typically above 90% of its steady state voltage. A pull-up resistor of more than 5 k Ω should be connected from PG to VOUT.

4.9 FB

The feedback (FB) pin is the control input for programming the output voltage. A resistor divider network is connected to this pin from the output and is compared to the internal 0.62V reference within the regulation loop.

The output voltage can be programmed between 1V and 3.3V using [Equation 4-1](#):

EQUATION 4-1:

$$V_{OUT} = V_{REF} \times \left(1 + \frac{R1}{R2}\right)$$

Where:

R1 = The top, VOUT-connected resistor.

R2 = The bottom, AGND-connected resistor.

[Table 4-1](#) shows example feedback resistor values.

TABLE 4-1: FEEDBACK RESISTOR VALUES

V _{OUT}	R1	R2
1.2V	274 k Ω	294 k Ω
1.5V	316 k Ω	221 k Ω
1.8V	301 k Ω	158 k Ω
2.5V	324 k Ω	107 k Ω
3.3V	309 k Ω	71.5 k Ω

5.0 APPLICATIONS INFORMATION

The MIC23451 is a triple high performance DC-to-DC step down regulator that offers a small solution size. Supporting three outputs with currents up to 2A inside a 4 mm × 4 mm FQFN package, the IC requires only five external components per channel while meeting today's miniature portable electronic device needs. Using the HyperLight Load[®] switching scheme, the MIC23451 can maintain high efficiency throughout the entire load range while providing ultra-fast load transient response. The following sections provide additional device application information.

5.1 Input Capacitor

A 2.2 μF or greater ceramic capacitor should be placed close to the PVIN pin for each channel and its corresponding PGND pin for bypassing. For example, the Murata GRM188R61E475KE11D, size 0603, 4.7 μF ceramic capacitor is ideal, based on performance, size, and cost. An X5R or X7R temperature rating is recommended for the input capacitor. Y5V temperature rating capacitors, in addition to losing most of their capacitance over temperature, can also become resistive at high frequencies. This reduces their ability to filter out high-frequency noise.

5.2 Output Capacitor

The MIC23451 is designed for use with a 2.2 μF or greater ceramic output capacitor. Increasing the output capacitance lowers output ripple and improves load transient response, but could also increase solution size or cost. A low equivalent series resistance (ESR) ceramic output capacitor, such as the Murata GRM188R61E475KE11D, size 0603, 4.7 μF ceramic capacitor, is recommended based on performance, size, and cost. Both the X7R or X5R temperature rating capacitors are recommended. The Y5V and Z5U temperature rating capacitors are not recommended due to their wide variation in capacitance over temperature and increased resistance at high frequencies.

5.3 Inductor Selection

When selecting an inductor, it is important to consider the following factors (not necessarily in order of importance):

- Inductance
- Rated current value
- Size requirements
- DC resistance (DCR)

The MIC23451 is designed for use with a 0.47 μH to 2.2 μH inductor. For faster transient response, a 0.47 μH inductor yields the best result. On the other

hand, a 2.2 μH inductor yields lower output voltage ripple. For the best compromise of these, a 1 μH is generally recommended.

Maximum current ratings of the inductor are generally given in two forms: permissible DC current and saturation current. Permissible DC current can be rated either for a 40°C temperature rise or a 10% to 20% loss in inductance. Make sure the inductor selected can handle the maximum operating current. When saturation current is specified, make sure that there is enough margin, so that the peak current does not cause the inductor to saturate. Peak current can be calculated as shown in Equation 5-1:

EQUATION 5-1:

$$I_{PEAK} = \left[I_{OUT} + V_{OUT} \times \left(\frac{1 - V_{OUT}/V_{IN}}{2 \times f \times L} \right) \right]$$

As this equation shows, the peak inductor current is inversely proportional to the switching frequency and the inductance; the lower the switching frequency or the inductance the higher the peak current. As input voltage increases, the peak current also increases.

The size of the inductor depends on the requirements of the application. Refer to the [Typical Application Schematic](#) and [Bill of Materials](#) sections for details.

DC resistance (DCR) is also important. While DCR is inversely proportional to size, DCR can represent a significant efficiency loss. Refer to the [Efficiency Considerations](#) section.

The transition between high loads (CCM) to HyperLight Load[®] (HLL) mode is determined by the inductor ripple current and the load current, as shown in Figure 5-1.

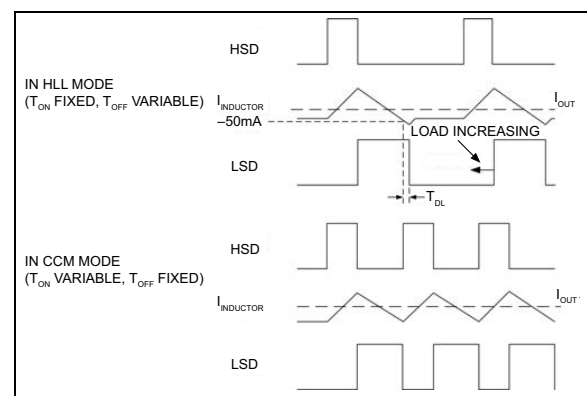

FIGURE 5-1: Transition between CCM Mode and HLL Mode.

The diagram shows the signals for high-side switch drive (HSD) for t_{ON} control, the inductor current, and the low-side switch drive (LSD) for t_{OFF} control.

MIC23451

In HLL mode, the inductor is charged with a fixed t_{ON} pulse on the high-side switch (HSD). After this, the LSD is switched on and current falls at a rate of V_{OUT}/L . The controller remains in HLL mode while the inductor falling current is detected to cross approximately -50 mA. When the LSD (or t_{OFF}) time reaches its minimum and the inductor falling current is no longer able to reach this -50 mA threshold, the part is in CCM mode and switching at a virtually constant frequency.

Once in CCM mode, the t_{OFF} time does not vary. Therefore, it is important to note that if L is large enough, the HLL transition level will not be triggered.

That inductor is:

EQUATION 5-2:

$$L_{MAX} = \frac{V_{OUT} \times 135ns}{2 \times 50mA}$$

5.4 Compensation

The MIC23451 is designed to be stable with a $0.47 \mu H$ to $2.2 \mu H$ inductor with a $4.7 \mu F$ ceramic (X5R) output capacitor.

5.5 Duty Cycle

The typical maximum duty cycle of the MIC23451 is 80%.

5.6 Efficiency Considerations

Efficiency is defined as the amount of useful output power, divided by the amount of power supplied.

EQUATION 5-3:

$$\text{Efficiency \%} = \left(\frac{V_{OUT} \times I_{OUT}}{V_{IN} \times I_{IN}} \right) \times 100$$

Maintaining high efficiency serves two purposes. It reduces power dissipation in the power supply, reducing the need for heat sinks and thermal design considerations, and it reduces current consumption for battery-powered applications. Reduced current draw from a battery increases the device's operating time and is critical in hand-held devices.

There are two types of losses in switching converters: DC losses and switching losses. DC losses are the power dissipation of I^2R . Power is dissipated in the high-side switch during the on cycle. Power loss is equal to the high-side MOSFET $R_{DS(ON)}$ multiplied by the switch current squared. During the off cycle, the low-side N-channel MOSFET conducts, also dissipating power. Device operating current also reduces efficiency. The product of the quiescent

(operating) current and the supply voltage represents another DC loss. The current required to drive the gates on and off at a constant 4 MHz frequency, and the switching transitions, make up the switching losses.

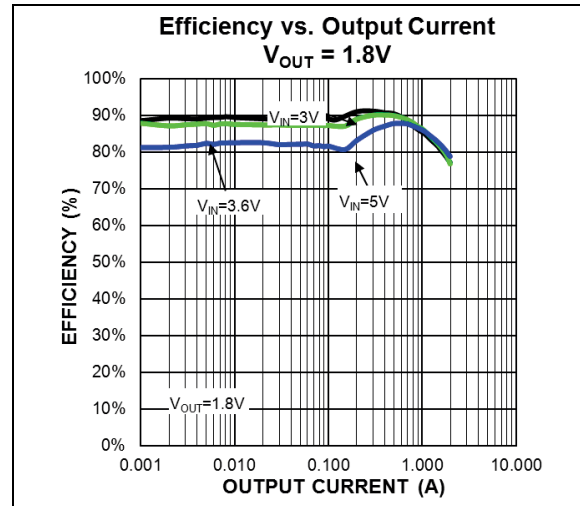

FIGURE 5-2: Efficiency Under Load.

Figure 5-2 shows an efficiency curve. From no load to 100 mA, efficiency losses are dominated by quiescent current losses, gate drive, and transition losses. By using the HyperLight Load mode, the MIC23451 can maintain high efficiency at low output currents.

Over 100 mA, efficiency loss is dominated by MOSFET $R_{DS(ON)}$ and inductor losses. Higher input supply voltages will increase the gate-to-source voltage on the internal MOSFETs, thereby reducing the internal $R_{DS(ON)}$. This improves efficiency by reducing DC losses in the device. All but the inductor losses are inherent to the device. Because of this, inductor selection becomes increasingly critical in efficiency calculations. As the inductors are reduced in size, the DC resistance (DCR) can become very significant. The DCR losses can be calculated as shown in Equation 5-4.

EQUATION 5-4:

$$P_{DCR} = I_{OUT}^2 \times DCR$$

From that, the loss in efficiency caused by inductor resistance can be calculated as shown in Equation 5-5.

EQUATION 5-5:

$$\text{Efficiency Loss} = \left[1 - \left(\frac{V_{OUT} \times I_{OUT}}{V_{OUT} \times I_{OUT} + P_{DCR}} \right) \right] \times 100$$

Efficiency loss caused by DCR is minimal at light loads and gains significance as the load is increased. Inductor selection becomes a trade-off between efficiency and size in this case.

5.7 Thermal Considerations

Most applications will not require 2A continuous current from all outputs at all times, so it is useful to know what the thermal limits are for various loading profiles.

The allowable overall package dissipation is limited by the intrinsic thermal resistance of the package ($R\theta_{(JC)}$) and the area of copper used to spread heat from the package case to the ambient surrounding temperature ($R\theta_{(CA)}$). The composite of these two thermal resistances is $R\theta_{(JA)}$, which represents the package thermal resistance with at least 1 square inch of copper ground plane. From this figure, which for the MIC23451 is 20°C/W, we can calculate maximum internal power dissipation, as shown in Equation 5-6:

EQUATION 5-6:

$$PD_{MAX} = \frac{T_{JMAX} - T_A}{R\theta_{(JA)}}$$

Where:

T_{JMAX} = Max. junction temperature (125°C)

T_A = Ambient temperature

$R\theta_{(JA)}$ = 20°C/W

The allowable dissipation tends towards zero as the ambient temperature increases towards the maximum operating junction temperature.

The graph of PD_{MAX} vs. ambient temperature could be drawn quite simply using this equation. However, a more useful measure is the maximum output current per regulator vs. ambient temperature. This requires creating an 'exchange rate' between power dissipation per regulator (P_{DISS}) and its output current (I_{OUT}).

An accurate measure of this function can use the efficiency curve, as illustrated in Equation 5-7:

EQUATION 5-7:

$$\eta = \frac{P_{OUT}}{P_{OUT} + P_{LOSS}}$$

$$P_{LOSS} = \frac{P_{OUT} \times (1 - \eta)}{\eta}$$

Where:

η = Efficiency

$P_{OUT} = I_{OUT} \times V_{OUT}$

To arrive at the internal package dissipation P_{DISS} , remove the inductor loss P_{DCR} , which is not dissipated within the package. This does not give a worst case figure because efficiency is typically measured on a nominal part at nominal temperatures. The I_{OUT} to P_{DISS} function used in this case is a synthesized P_{DISS} , which accounts for worst case values at maximum operating temperature, as shown in Equation 5-8.

EQUATION 5-8:

$$P_{DISS} = I_{OUT}^2 \left[R_{DS(ON_P)} \times \frac{V_{OUT}}{V_{IN}} + R_{DS(ON_N)} \times \left(1 - \frac{V_{OUT}}{V_{IN}} \right) \right]$$

Where:

$R_{DS(ON_P)}$ = Max. $R_{DS(ON)}$ of the high-side P-channel switch at T_{JMAX}

$R_{DS(ON_N)}$ = Max. $R_{DS(ON)}$ of the low-side N-channel switch at T_{JMAX}

V_{OUT} = Output voltage

V_{IN} = Input voltage

Because ripple current and switching losses are small with respect to resistive losses at maximum output current, they can be considered negligible for the purpose of this method, but could be included if required.

Using the function describing P_{DISS} in terms of I_{OUT} , substitute P_{DISS} with Equation 5-6 to form the function of maximum output current I_{OUTMAX} vs. ambient temperature T_A (Equation 5-9):

EQUATION 5-9:

$$I_{OUTMAX} = \sqrt{\frac{\frac{T_{JMAX} - T_A}{R\theta_{JA}}}{R_{DS(ON_P)} \times \frac{V_{OUT}}{V_{IN}} + R_{DS(ON_N)} \times \left(1 - \frac{V_{OUT}}{V_{IN}} \right)}}$$

The curves shown in the Typical Performance Curves section are plots of this function adjusted to account for 1, 2, or 3 regulators running simultaneously.

5.8 HyperLight Load Mode

Each regulator in the MIC23451 uses a minimum on and off time proprietary control loop (patented by Microchip). When the output voltage falls below the regulation threshold, the error comparator begins a switching cycle that turns the PMOS on and keeps it on for the duration of the minimum-on-time. This increases the output voltage. If the output voltage is over the regulation threshold, then the error comparator turns the PMOS off for a minimum-off-time until the output drops below the threshold. The NMOS acts as an ideal rectifier that conducts when the PMOS is off. Using an NMOS switch instead of a diode allows for lower voltage drop across the switching device when it is on.

MIC23451

The asynchronous switching combination between the PMOS and the NMOS allows the control loop to work in discontinuous mode for light load operations. In discontinuous mode, the MIC23451 works in pulse-frequency modulation (PFM) to regulate the output. As the output current increases, the off-time decreases, which provides more energy to the output. This switching scheme improves the efficiency of MIC23451 during light load currents by switching only when it is needed. As the load current increases, the MIC23451 goes into continuous conduction mode (CCM) and switches at a frequency centered at 3 MHz. The equation to calculate the load when the MIC23451 goes into continuous conduction mode is approximated in Equation 5-10.

EQUATION 5-10:

$$I_{LOAD} > \frac{(V_{IN} - V_{OUT}) \times D}{2L \times f}$$

As shown in that equation, the load at which the MIC23451 transitions from HyperLight Load mode to PWM mode is a function of the input voltage (V_{IN}), output voltage (V_{OUT}), duty cycle (D), inductance (L), and frequency (f). Figure 5-3 shows that as the output current increases, the switching frequency also increases until the MIC23451 goes from HyperLight Load mode to PWM mode at approximately 120 mA. The MIC23451 will switch at a relatively constant frequency around 3 MHz after the output current is over 120 mA.

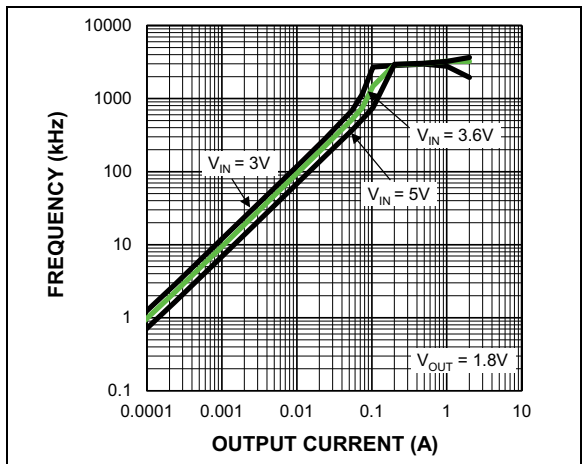

FIGURE 5-3: Switching Frequency vs. Output Current.

5.9 Multiple Sources

The MIC23451 provides all the pins necessary to operate the three regulators from independent sources. This can be useful in partitioning power within a multi-rail system. For example, two supplies may be available within a system: 3.3V and 5V. The MIC23451 can be connected to use the 3.3V supply to provide two, low-voltage outputs (for example, 1.2V and 1.8V) and use the 5V rail to provide a higher output (for example, 2.5V), resulting in the power blocks shown in Figure 5-4.

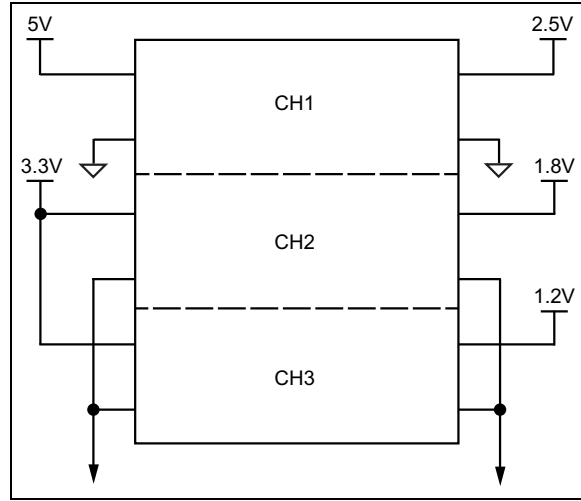

FIGURE 5-4: Multi-Source Power Block Diagram.

6.0 TYPICAL APPLICATION SCHEMATIC

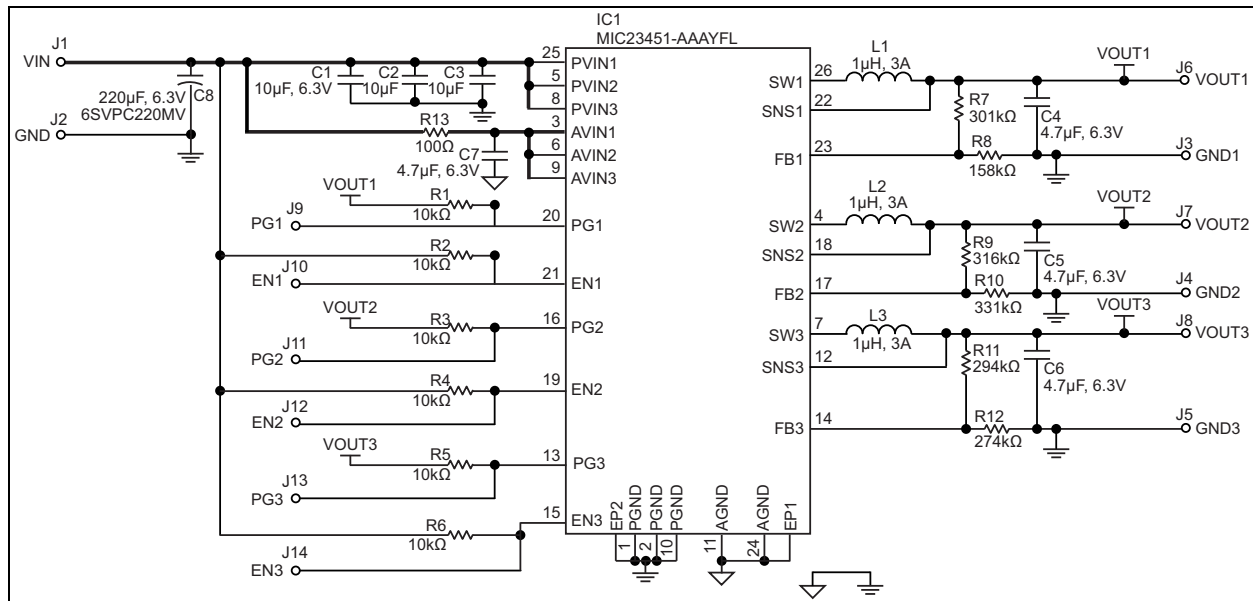

FIGURE 6-1: MIC23451 Typical Application Schematic.

6.1 Recommended Bill of Materials

TABLE 6-1: BILL OF MATERIALS

Item	Part Number	Manufacturer	Description	Qty.
C1, C2, C3	GRM188R60J106ME47J	Murata	Capacitor, 10 µF, Size 0603	3
C4, C5, C6, C7	CGB3B3X5R0J475K055AB	TDK	Capacitor, 4.7 µF, Size 0603	4
	GRM188R61E475KE11D	Murata		
C8	EEU-FR1A221B	Panasonic	Electrolytic Capacitor, 220 µF, 10V, Size 6.3 mm	1
R1, R2, R3, R4, R5, R6	CRCW060310K0FKEA	Vishay	Resistor, 10 kΩ, Size 0603	6
R7	CRCW0603301K0FKEA	Vishay	Resistor, 301 kΩ, Size 0603	1
R8	CRCW0603158K0FKEA	Vishay	Resistor, 158 kΩ, Size 0603	1
R9	CRCW0603316K0FKEA	Vishay	Resistor, 316Ω, Size 0603	1
R10	CRCW0603331K0FKEA	Vishay	Resistor, 331 kΩ, Size 0603	1
R11	CRCW0603294K0FKEA	Vishay	Resistor, 294 kΩ, Size 0603	1
R12	CRCW0603274K0FKEA	Vishay	Resistor, 274 kΩ, Size 0603	1
L1, L2, L3	VLS3012HBX-1R0M	TDK	1 µH, 2A, 60 mΩ, L3.0 mm x W3.0 mm x H1.0 mm	3
	LQH44PN1R0NJ0	Murata	1 µH, 2.8A, 50 mΩ, L4.0 mm x W4.0 mm x H1.2 mm	
U1	MIC23451-AAAYFL	Microchip	3 MHz PWM 2A Buck Regulator with HyperLight® Load	1

MIC23451

7.0 PCB LAYOUT RECOMMENDATIONS

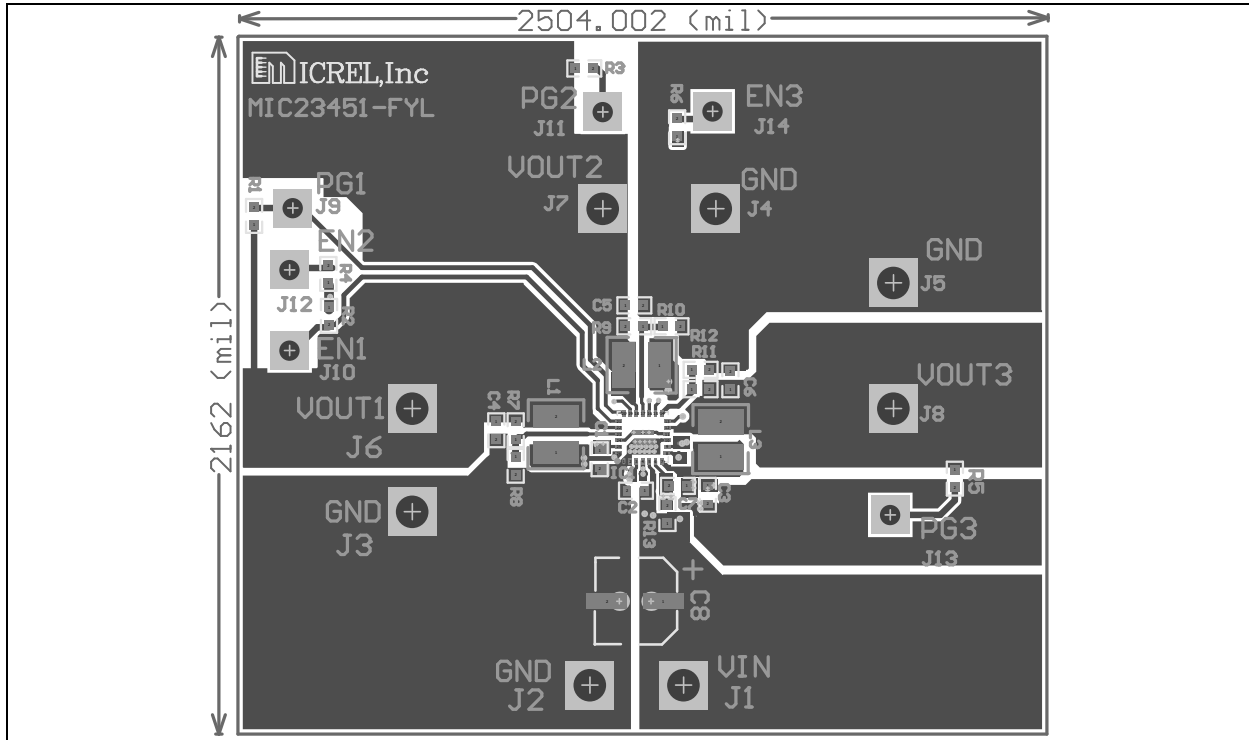

FIGURE 7-1: Top Layer.

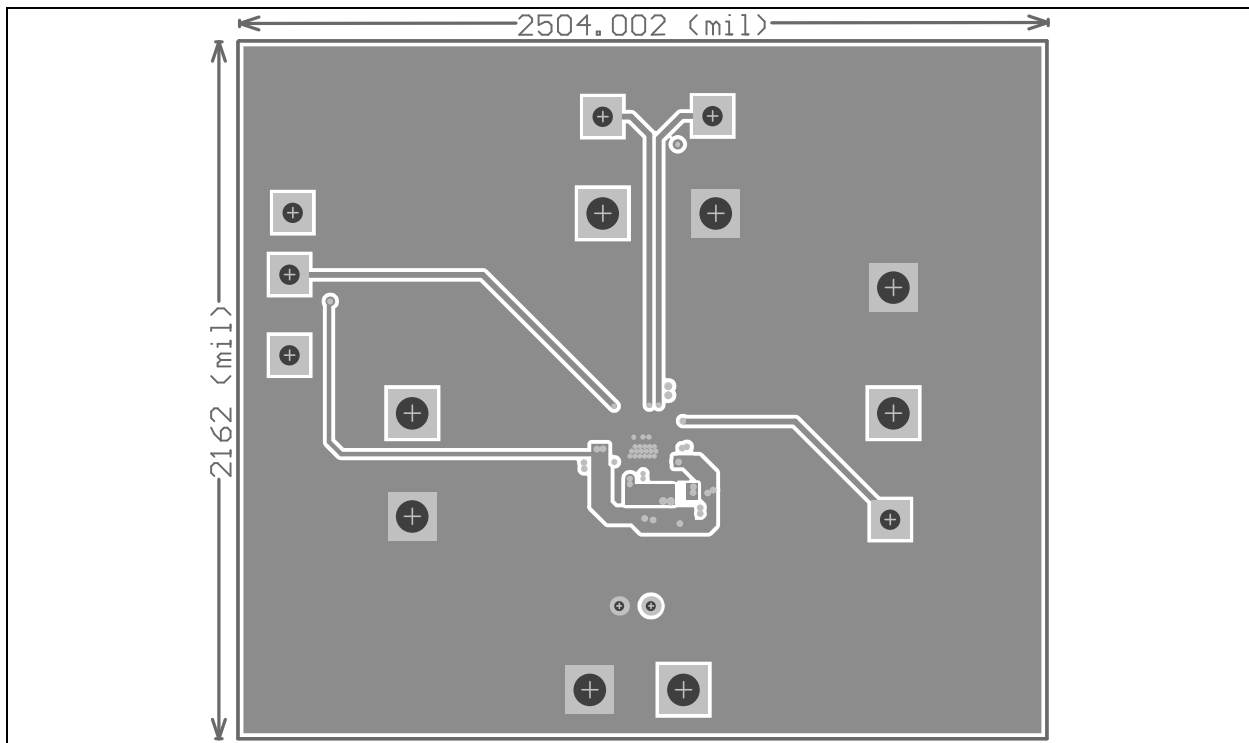

FIGURE 7-2: Mid Layer 1.

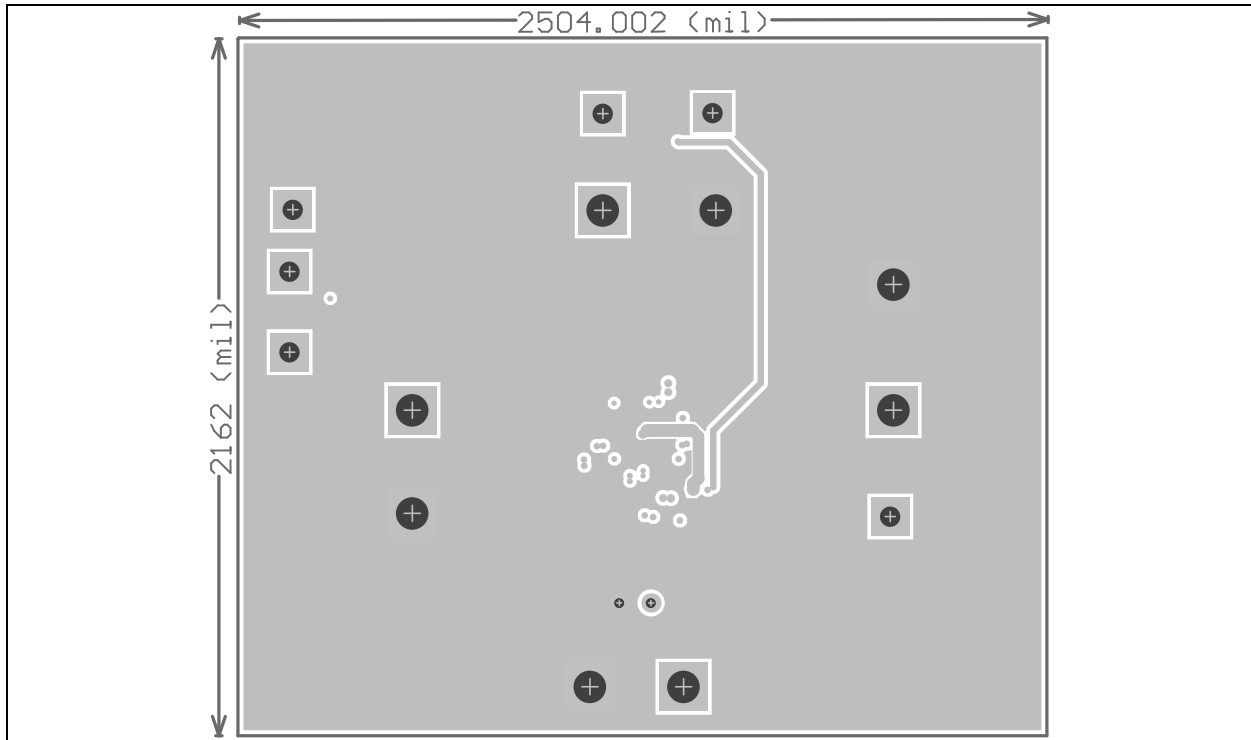

FIGURE 7-3: Mid Layer 2.

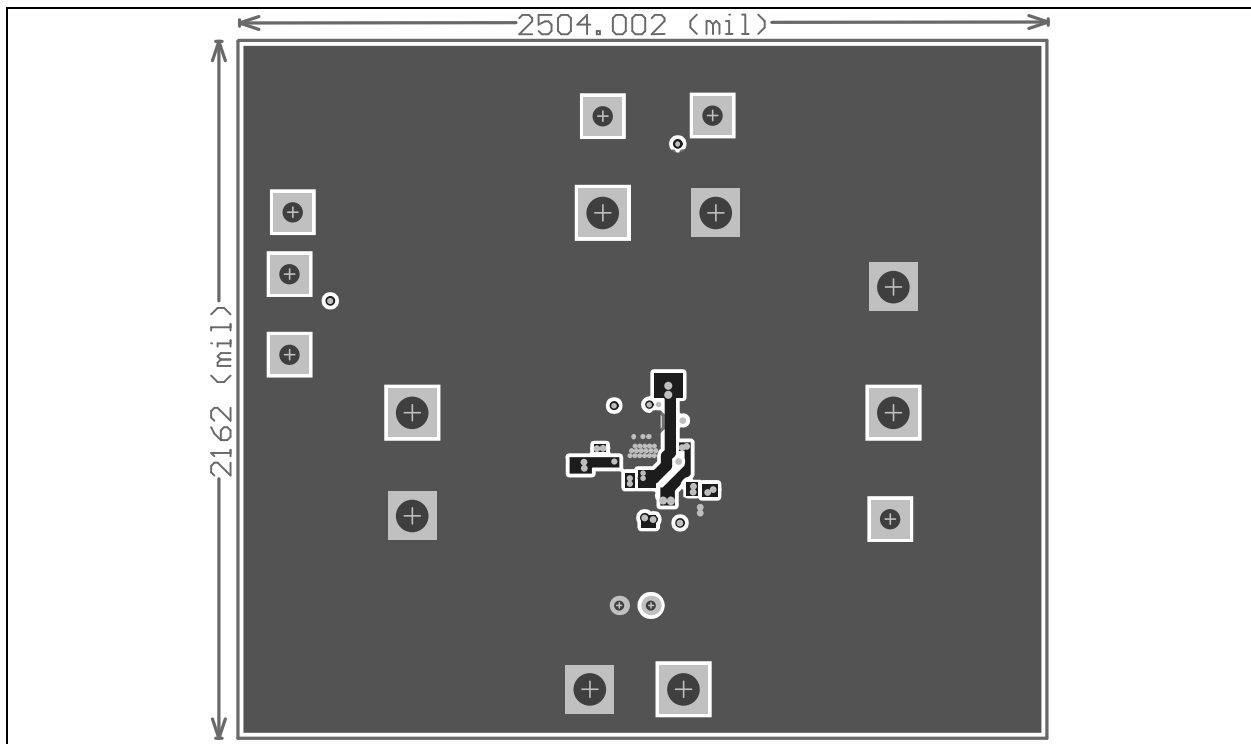

FIGURE 7-4: Bottom Layer.

MIC23451

8.0 PACKAGING INFORMATION

8.1 Package Marking Information

26-Lead FQFN*

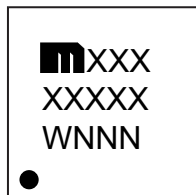

Example

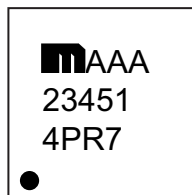

Legend:	XX...X	Product code or customer-specific information
	Y	Year code (last digit of calendar year)
	YY	Year code (last 2 digits of calendar year)
	WW	Week code (week of January 1 is week '01')
	NNN	Alphanumeric traceability code
	(e3)	Pb-free JEDEC® designator for Matte Tin (Sn)
	*	This package is Pb-free. The Pb-free JEDEC designator ((e3)) can be found on the outer packaging for this package.
	•, ▲, ▼	Pin one index is identified by a dot, delta up, or delta down (triangle mark).
Note:	In the event the full Microchip part number cannot be marked on one line, it will be carried over to the next line, thus limiting the number of available characters for customer-specific information. Package may or may not include the corporate logo. Underbar (_) symbol may not be to scale.	

Note: If the full seven-character YYWWNNN code cannot fit on the package, the following truncated codes are used based on the available marking space:
6 Characters = YWWNNN; 5 Characters = WWNNN; 4 Characters = WNNN; 3 Characters = NNN;
2 Characters = NN; 1 Character = N

26-Lead 4 mm x 4 mm FQFN Package Outline and Recommended Land Pattern

TITLE

26 LEAD FQFN 4x4mm PACKAGE (Flip Chip) OUTLINE & RECOMMENDED LAND PATTERN

DRAWING #	FQFN44-26LD-PL-1	UNIT	MM
-----------	------------------	------	----

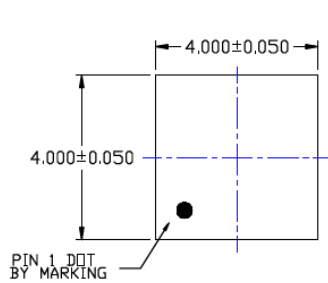

TOP VIEW

NOTE : 1, 2, 3

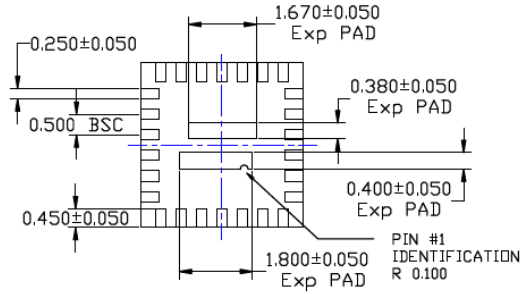

BOTTOM VIEW

NOTE : 1, 2

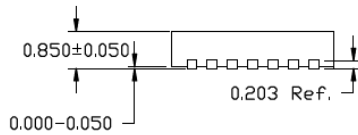

SIDE VIEW

NOTE : 1, 2

NOTE:

1. Max package warpage is 0.05mm.
2. Max allowable burr is 0.076mm in all directions.
3. Pin #1 will be laser marked.
4. Red circle in PGND indicate thermal via. Size should be 0.20mm in diameter, 0.40mm pitch and should be connected to GND for max thermal performance.
5. Blue colored pad & circle indicate SGND, do not connect to GND.

Note: For the most current package drawings, please see the Microchip Packaging Specification located at <http://www.microchip.com/packaging>.

MIC23451

POD-Land Pattern drawing #FQFN44-2 6LD-PL-1

RECOMMENDED LAND PATTERN

NOTE : 4, 5

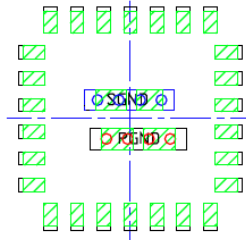

STACKED-UP

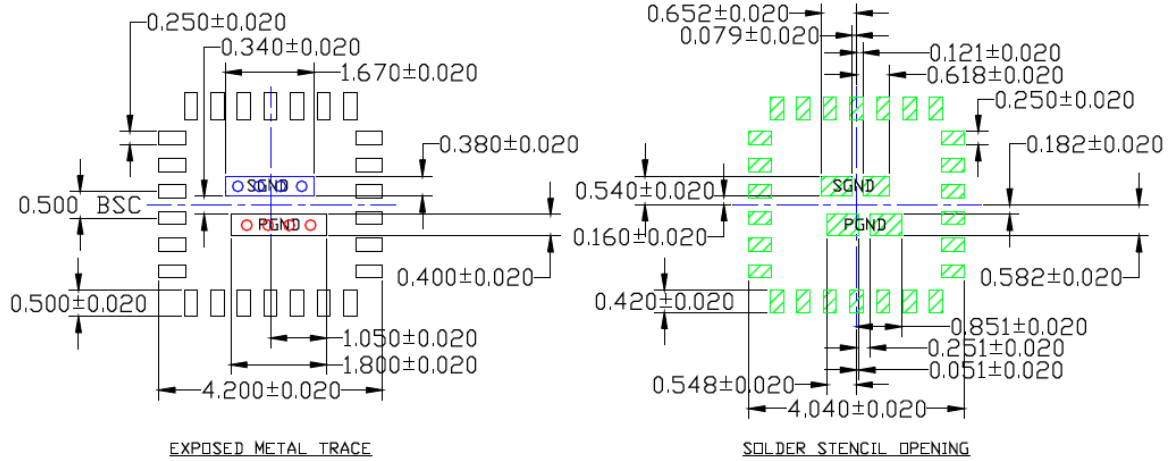

Note: For the most current package drawings, please see the Microchip Packaging Specification located at <http://www.microchip.com/packaging>.

APPENDIX A: REVISION HISTORY

Revision A (April 2022)

- Converted Micrel document MIC23451 to Microchip data sheet DS20006662A.
- Minor text changes throughout.

MIC23451

NOTES:

PRODUCT IDENTIFICATION SYSTEM

To order or obtain information, e.g., on pricing or delivery, contact your local Microchip representative or sales office.

<u>Part Number</u>	<u>-XXX</u>	<u>X</u>	<u>XX</u>	<u>-XX</u>	Examples:
Device	Output Voltage	Temp. Range	Package	Media Type	
Device:	MIC23451:	3 MHz, 2A Triple Synchronous Buck Regulator with HyperLight Load® and Power Good			a) MIC23451-AAAYFL-TR: MIC23451, Triple Adj. Output Voltage, -40°C to +125°C Temp. Range, 26-Lead FQFN, 5,000/Reel
Output Voltage:	AAA =	Adjustable/Adjustable/Adjustable			b) MIC23451-AAAYFL-T5: MIC23451, Triple Adj. Output Voltage, -40°C to +125°C Temp. Range, 26-Lead FQFN, 500/Reel
Temperature Range:	Y =	-40°C to +125°C			Note 1: Tape and Reel identifier only appears in the catalog part number description. This identifier is used for ordering purposes and is not printed on the device package. Check with your Microchip Sales Office for package availability with the Tape and Reel option.
Package:	FL =	26-Lead FQFN			
Media Type:	TR =	5,000/Reel			
	T5 =	500/Reel			

MIC23451

NOTES:

Note the following details of the code protection feature on Microchip products:

- Microchip products meet the specifications contained in their particular Microchip Data Sheet.
- Microchip believes that its family of products is secure when used in the intended manner, within operating specifications, and under normal conditions.
- Microchip values and aggressively protects its intellectual property rights. Attempts to breach the code protection features of Microchip product is strictly prohibited and may violate the Digital Millennium Copyright Act.
- Neither Microchip nor any other semiconductor manufacturer can guarantee the security of its code. Code protection does not mean that we are guaranteeing the product is “unbreakable”. Code protection is constantly evolving. Microchip is committed to continuously improving the code protection features of our products.

This publication and the information herein may be used only with Microchip products, including to design, test, and integrate Microchip products with your application. Use of this information in any other manner violates these terms. Information regarding device applications is provided only for your convenience and may be superseded by updates. It is your responsibility to ensure that your application meets with your specifications. Contact your local Microchip sales office for additional support or, obtain additional support at <https://www.microchip.com/en-us/support/design-help/client-support-services>.

THIS INFORMATION IS PROVIDED BY MICROCHIP "AS IS". MICROCHIP MAKES NO REPRESENTATIONS OR WARRANTIES OF ANY KIND WHETHER EXPRESS OR IMPLIED, WRITTEN OR ORAL, STATUTORY OR OTHERWISE, RELATED TO THE INFORMATION INCLUDING BUT NOT LIMITED TO ANY IMPLIED WARRANTIES OF NON-INFRINGEMENT, MERCHANTABILITY, AND FITNESS FOR A PARTICULAR PURPOSE, OR WARRANTIES RELATED TO ITS CONDITION, QUALITY, OR PERFORMANCE.

IN NO EVENT WILL MICROCHIP BE LIABLE FOR ANY INDIRECT, SPECIAL, PUNITIVE, INCIDENTAL, OR CONSEQUENTIAL LOSS, DAMAGE, COST, OR EXPENSE OF ANY KIND WHATSOEVER RELATED TO THE INFORMATION OR ITS USE, HOWEVER CAUSED, EVEN IF MICROCHIP HAS BEEN ADVISED OF THE POSSIBILITY OR THE DAMAGES ARE FORESEEABLE. TO THE FULLEST EXTENT ALLOWED BY LAW, MICROCHIP'S TOTAL LIABILITY ON ALL CLAIMS IN ANY WAY RELATED TO THE INFORMATION OR ITS USE WILL NOT EXCEED THE AMOUNT OF FEES, IF ANY, THAT YOU HAVE PAID DIRECTLY TO MICROCHIP FOR THE INFORMATION.

Use of Microchip devices in life support and/or safety applications is entirely at the buyer's risk, and the buyer agrees to defend, indemnify and hold harmless Microchip from any and all damages, claims, suits, or expenses resulting from such use. No licenses are conveyed, implicitly or otherwise, under any Microchip intellectual property rights unless otherwise stated.

For information regarding Microchip's Quality Management Systems, please visit www.microchip.com/quality.

Trademarks

The Microchip name and logo, the Microchip logo, Adaptec, AnyRate, AVR, AVR logo, AVR Freaks, BesTime, BitCloud, CryptoMemory, CryptoRF, dsPIC, flexPWR, HELDO, IGLOO, JukeBlox, KeeLoq, Kleer, LANCheck, LinkMD, maXStylus, maXTouch, MediaLB, megaAVR, Microsemi, Microsemi logo, MOST, MOST logo, MPLAB, OptoLyzr, PIC, picoPower, PICSTART, PIC32 logo, PolarFire, Prochip Designer, QTouch, SAM-BA, SenGenuity, SpyNIC, SST, SST Logo, SuperFlash, Symmetricom, SyncServer, Tachyon, TimeSource, tinyAVR, UNI/O, Vectron, and XMEGA are registered trademarks of Microchip Technology Incorporated in the U.S.A. and other countries.

AgileSwitch, APT, ClockWorks, The Embedded Control Solutions Company, EtherSynch, Flashtec, Hyper Speed Control, HyperLight Load, IntelliMOS, Libero, motorBench, mTouch, Powermite 3, Precision Edge, ProASIC, ProASIC Plus, ProASIC Plus logo, QuietWire, SmartFusion, SyncWorld, Temux, TimeCesium, TimeHub, TimePictra, TimeProvider, TrueTime, WinPath, and ZL are registered trademarks of Microchip Technology Incorporated in the U.S.A.

Adjacent Key Suppression, AKS, Analog-for-the-Digital Age, Any Capacitor, AnyIn, AnyOut, Augmented Switching, BlueSky, BodyCom, CodeGuard, CryptoAuthentication, CryptoAutomotive, CryptoCompanion, CryptoController, dsPICDEM, dsPICDEM.net, Dynamic Average Matching, DAM, ECAN, Espresso T1S, EtherGREEN, GridTime, IdealBridge, In-Circuit Serial Programming, ICSP, INICnet, Intelligent Paralleling, Inter-Chip Connectivity, JitterBlocker, Knob-on-Display, maxCrypto, maxView, memBrain, Mindi, MiWi, MPASM, MPF, MPLAB Certified logo, MPLIB, MPLINK, MultiTRAK, NetDetach, NVM Express, NVMe, Omniscient Code Generation, PICDEM, PICDEM.net, PICkit, PICtail, PowerSmart, PureSilicon, QMatrix, REAL ICE, Ripple Blocker, RTAX, RTG4, SAM-ICE, Serial Quad I/O, simpleMAP, SimpliPHY, SmartBuffer, SmartHLS, SMART-I.S., storClad, SQI, SuperSwitcher, SuperSwitcher II, Switchtec, SynchroPHY, Total Endurance, TSHARC, USBCheck, VariSense, VectorBlox, VeriPHY, ViewSpan, WiperLock, XpressConnect, and ZENA are trademarks of Microchip Technology Incorporated in the U.S.A. and other countries.

SQTP is a service mark of Microchip Technology Incorporated in the U.S.A.

The Adaptec logo, Frequency on Demand, Silicon Storage Technology, Symmcom, and Trusted Time are registered trademarks of Microchip Technology Inc. in other countries.

GestIC is a registered trademark of Microchip Technology Germany II GmbH & Co. KG, a subsidiary of Microchip Technology Inc., in other countries.

All other trademarks mentioned herein are property of their respective companies.

© 2022, Microchip Technology Incorporated and its subsidiaries.

All Rights Reserved.

ISBN: 978-1-6683-0195-1



MICROCHIP

Worldwide Sales and Service

AMERICAS

Corporate Office
2355 West Chandler Blvd.
Chandler, AZ 85224-6199
Tel: 480-792-7200
Fax: 480-792-7277
Technical Support:
<http://www.microchip.com/support>
Web Address:
www.microchip.com

Atlanta

Duluth, GA
Tel: 678-957-9614
Fax: 678-957-1455

Austin, TX

Tel: 512-257-3370

Boston

Westborough, MA
Tel: 774-760-0087
Fax: 774-760-0088

Chicago

Itasca, IL
Tel: 630-285-0071
Fax: 630-285-0075

Dallas

Addison, TX
Tel: 972-818-7423
Fax: 972-818-2924

Detroit

Novi, MI
Tel: 248-848-4000

Houston, TX

Tel: 281-894-5983

Indianapolis

Noblesville, IN
Tel: 317-773-8323
Fax: 317-773-5453
Tel: 317-536-2380

Los Angeles

Mission Viejo, CA
Tel: 949-462-9523
Fax: 949-462-9608
Tel: 951-273-7800

Raleigh, NC

Tel: 919-844-7510

New York, NY

Tel: 631-435-6000

San Jose, CA

Tel: 408-735-9110
Tel: 408-436-4270

Canada - Toronto

Tel: 905-695-1980
Fax: 905-695-2078

ASIA/PACIFIC

Australia - Sydney
Tel: 61-2-9868-6733

China - Beijing
Tel: 86-10-8569-7000

China - Chengdu
Tel: 86-28-8665-5511

China - Chongqing
Tel: 86-23-8980-9588

China - Dongguan
Tel: 86-769-8702-9880

China - Guangzhou
Tel: 86-20-8755-8029

China - Hangzhou
Tel: 86-571-8792-8115

China - Hong Kong SAR
Tel: 852-2943-5100

China - Nanjing
Tel: 86-25-8473-2460

China - Qingdao
Tel: 86-532-8502-7355

China - Shanghai
Tel: 86-21-3326-8000

China - Shenyang
Tel: 86-24-2334-2829

China - Shenzhen
Tel: 86-755-8864-2200

China - Suzhou
Tel: 86-186-6233-1526

China - Wuhan
Tel: 86-27-5980-5300

China - Xian
Tel: 86-29-8833-7252

China - Xiamen
Tel: 86-592-2388138

China - Zhuhai
Tel: 86-756-3210040

ASIA/PACIFIC

India - Bangalore
Tel: 91-80-3090-4444

India - New Delhi
Tel: 91-11-4160-8631

India - Pune
Tel: 91-20-4121-0141

Japan - Osaka
Tel: 81-6-6152-7160

Japan - Tokyo
Tel: 81-3-6880-3770

Korea - Daegu
Tel: 82-53-744-4301

Korea - Seoul
Tel: 82-2-554-7200

Malaysia - Kuala Lumpur
Tel: 60-3-7651-7906

Malaysia - Penang
Tel: 60-4-227-8870

Philippines - Manila
Tel: 63-2-634-9065

Singapore
Tel: 65-6334-8870

Taiwan - Hsin Chu
Tel: 886-3-577-8366

Taiwan - Kaohsiung
Tel: 886-7-213-7830

Taiwan - Taipei
Tel: 886-2-2508-8600

Thailand - Bangkok
Tel: 66-2-694-1351

Vietnam - Ho Chi Minh
Tel: 84-28-5448-2100

EUROPE

Austria - Wels
Tel: 43-7242-2244-39
Fax: 43-7242-2244-393

Denmark - Copenhagen
Tel: 45-4485-5910
Fax: 45-4485-2829

Finland - Espoo
Tel: 358-9-4520-820

France - Paris
Tel: 33-1-69-53-63-20
Fax: 33-1-69-30-90-79

Germany - Garching
Tel: 49-8931-9700

Germany - Haan
Tel: 49-2129-3766400

Germany - Heilbronn
Tel: 49-7131-72400

Germany - Karlsruhe
Tel: 49-721-625370

Germany - Munich
Tel: 49-89-627-144-0
Fax: 49-89-627-144-44

Germany - Rosenheim
Tel: 49-8031-354-560

Israel - Ra'anana
Tel: 972-9-744-7705

Italy - Milan
Tel: 39-0331-742611
Fax: 39-0331-466781

Italy - Padova
Tel: 39-049-7625286

Netherlands - Drunen
Tel: 31-416-690399
Fax: 31-416-690340

Norway - Trondheim
Tel: 47-7288-4388

Poland - Warsaw
Tel: 48-22-3325737

Romania - Bucharest
Tel: 40-21-407-87-50

Spain - Madrid
Tel: 34-91-708-08-90
Fax: 34-91-708-08-91

Sweden - Gothenberg
Tel: 46-31-704-60-40

Sweden - Stockholm
Tel: 46-8-5090-4654

UK - Wokingham
Tel: 44-118-921-5800
Fax: 44-118-921-5820

Mouser Electronics

Authorized Distributor

Click to View Pricing, Inventory, Delivery & Lifecycle Information:

[Microchip:](#)

[MIC23451-AAAYFL T5](#) [MIC23451-AAAYFL TR](#) [MIC23451-AAAYFL-TR](#) [MIC23451-AAAYFL-T5](#)