

# Precision Operational Amplifier, 25 $\mu\text{V}$ Offset, Zero-Drift, 36 V Supply, 2 MHz



ON Semiconductor®

[www.onsemi.com](http://www.onsemi.com)

## NCS21911, NCV21911, NCS21912, NCV21912, NCS21914, NCV21914

The NCS2191x family of high precision op amps feature low input offset voltage and near-zero drift over time and temperature. These op amps operate over a wide supply range from 4 V to 36 V with low quiescent current. The rail-to-rail output swings within 10 mV of the rails. The family includes the single channel NCS(V)21911, the dual channel NCS(V)21912, and the quad channel NCS(V)21914 in a variety of packages. All versions are specified for operation from  $-40^{\circ}\text{C}$  to  $+125^{\circ}\text{C}$ . Automotive qualified options are available under the NCV prefix.

### Features

- Input Offset Voltage:  $\pm 25 \mu\text{V}$  max
- Zero-Drift Offset Voltage:  $\pm 0.085 \mu\text{V}/^{\circ}\text{C}$  max
- Voltage Noise Density: 22 nV/ $\sqrt{\text{Hz}}$  typical
- Unity Gain Bandwidth: 2 MHz typical
- Supply Voltage: 4 V to 36 V
- Quiescent Current: 570  $\mu\text{A}$  max
- Rail-to-Rail Output
- NCV Prefix for Automotive and Other Applications Requiring Unique Site and Control Change Requirements; AEC-Q100 Qualified and PPAP Capable
- These Devices are Pb-free, Halogen free/BFR free and are RoHS compliant

### Typical Applications

- Temperature Measurements
- Transducer Applications
- Electronic Scales
- Medical Instrumentation
- Current Sensing
- Automotive

### MARKING DIAGRAMS

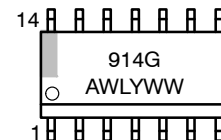
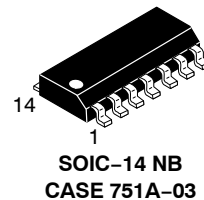
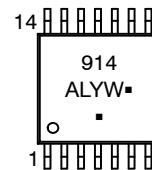
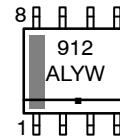
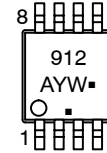
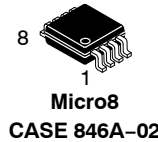
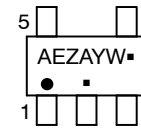

XXXXX = Specific Device Code  
A = Assembly Location  
L or WL = Wafer Lot  
Y = Year  
W = Work Week  
▪ = Pb-Free Package

(Note: Microdot may be in either location)

### ORDERING INFORMATION

See detailed ordering and shipping information on page 2 of this data sheet.

# NCS21911, NCV21911, NCS21912, NCV21912, NCS21914, NCV21914

## PIN CONNECTIONS

Single Channel Configuration  
NCS21911

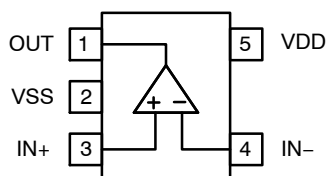

Dual Channel Configuration  
NCS21912

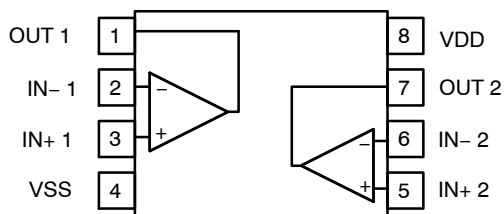

Quad Channel Configuration  
NCS21914

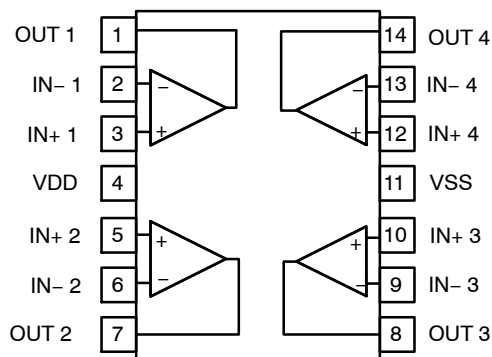

## ORDERING INFORMATION

Channels	Device	Package	Shipping †
Single	NCS21911SN2T1G	SOT23-5 / TSOP-5	3000 / Tape & Reel
Dual	NCS21912DR2G	SOIC-8	2500 / Tape & Reel
	NCS21912DMR2G	MICRO-8	4000 / Tape & Reel
Quad	NCS21914DR2G	SOIC-14	2500 / Tape & Reel
	NCS21914DTBR2G	TSSOP-14	2500 / Tape & Reel
<b>Automotive Qualified</b>			
Channels	Device	Package	Shipping †
Single	NCV21911SN2T1G	SOT23-5 / TSOP-5	3000 / Tape & Reel
Dual	NCV21912DR2G	SOIC-8	2500 / Tape & Reel
	NCV21912DMR2G	MICRO-8	4000 / Tape & Reel
Quad	NCV21914DR2G	SOIC-14	2500 / Tape & Reel
	NCV21914DTBR2G	TSSOP-14	2500 / Tape & Reel

†For information on tape and reel specifications, including part orientation and tape sizes, please refer to our Tape and Reel Packaging Specification Brochure, BRD8011/D.

# NCS21911, NCV21911, NCS21912, NCV21912, NCS21914, NCV21914

## ABSOLUTE MAXIMUM RATINGS

Parameter	Rating	Unit
Supply Voltage (VDD– VSS)	40	V

### INPUT AND OUTPUT PINS

Input Voltage (Note 1)	VSS – 0.3 to VDD + 0.3	V
Differential Input Voltage (Note 2)	±17	V
Input Current (Notes 1 and 2)	±10	mA
Output Short Circuit Current (Note 3)	Continuous	mA

### TEMPERATURE

Operating Temperature	–40 to +125	°C
Storage Temperature	–65 to +150	°C
Junction Temperature	+150	°C

### ESD RATINGS (Note 4)

Human Body Model (HBM)	3000	V
Charged Device Model (CDM)	2000	V

### OTHER RATINGS

Latch–up Current (Note 5)	100	mA
MSL	Level 1	

Stresses exceeding those listed in the Maximum Ratings table may damage the device. If any of these limits are exceeded, device functionality should not be assumed, damage may occur and reliability may be affected.

- Input terminals are diode–clamped to the power–supply rails. Input signals that can swing more than 0.3 V beyond the supply rails should be current limited to 10 mA or less.
- The inputs are diode connected with a total input protection of 1.65 kΩ, increasing the absolute maximum differential voltage to ±17 V<sub>DC</sub>. If the applied differential voltage is expected to exceed this rating, external resistors should be added in series with the inputs to limit the input current to ±10 mA.
- Short–circuit to V<sub>DD</sub> or V<sub>SS</sub>. Short circuits to either rail can cause an increase in the junction temperature. The total power dissipation must be limited to prevent the junction temperature from exceeding the 150°C limit.
- This device series incorporates ESD protection and is tested by the following methods:  
ESD Human Body Model tested per JEDEC standard JS–001–2017 (AEC–Q100–002)  
ESD Charged Device Model tested per JEDEC standard JS–002–2014 (AEC–Q100–011)
- Latch–up Current tested per JEDEC standard JESD78E (AEC–Q100–004).

## THERMAL INFORMATION (Note 6)

Rating	Symbol	Package	Value	Unit
Thermal Resistance, Junction to Ambient	$\theta_{JA}$	TSOP–5 / SOT23–5	170	°C/W
		Micro8/MSOP8	116	
		SOIC–8	87	
		SOIC–14	59	
		TSSOP–14	78	

- As mounted on an 80x80x1.5 mm FR4 PCB with 2S2P, 2 oz copper, and a 200 mm<sup>2</sup> heat spreader area. Following JEDEC JESD51–7 guidelines.

## OPERATING CONDITIONS

Parameter	Symbol	Range	Unit
Supply Voltage (V <sub>DD</sub> – V <sub>SS</sub> )	V <sub>S</sub>	4 to 36	V
Specified Operating Temperature Range	T <sub>A</sub>	–40 to 125	°C
Input Common Mode Voltage Range	V <sub>CM</sub>	V <sub>SS</sub> to V <sub>DD</sub> –1.5	V
Differential Voltage (Note 7)	V <sub>DIFF</sub>	±17	V

- The inputs are diode connected with a total input protection of 1.65 kΩ, increasing the absolute maximum differential voltage to ±17 V<sub>DC</sub>. If the applied differential voltage is expected to exceed this rating, external resistors should be added in series with the inputs to limit the input current to ±10 mA.

# NCS21911, NCV21911, NCS21912, NCV21912, NCS21914, NCV21914

## ELECTRICAL CHARACTERISTICS $V_S = 4\text{ V to }36\text{ V}$

At  $T_A = +25^\circ\text{C}$ ,  $R_L = 10\text{ k}\Omega$  connected to midsupply,  $V_{CM} = V_{OUT} = \text{midsupply}$ , unless otherwise noted.

**Boldface** limits apply over the specified temperature range,  $T_A = -40^\circ\text{C to }125^\circ\text{C}$ , guaranteed by characterization and/or design.

Parameter	Symbol	Conditions	Min	Typ	Max	Unit	
<b>INPUT CHARACTERISTICS</b>							
Offset Voltage	$V_{OS}$			$\pm 1$	$\pm 25$	$\mu\text{V}$	
Offset Voltage Drift vs Temp	$\Delta V_{OS}/\Delta T$			$\pm 0.02$	$\pm 0.085$	$\mu\text{V}/^\circ\text{C}$	
Input Bias Current (Note 8)	$I_{IB}$			$\pm 100$	$\pm 500$	$\text{pA}$	
					<b><math>\pm 3500</math></b>	$\text{pA}$	
Input Offset Current (Note 8)	$I_{OS}$			$\pm 200$	$\pm 500$	$\text{pA}$	
					<b><math>\pm 3500</math></b>	$\text{pA}$	
Common Mode Rejection Ratio	CMRR	$V_{SS} \leq V_{CM} \leq V_{DD} - 1.5\text{ V}$	$V_S = 36\text{ V}$	140	150		dB
				<b>130</b>			
			$V_S = 12\text{ V}$ (Note 8)	130	150		
				<b>120</b>			
			$V_S = 8\text{ V}$ (Note 8)	130	140		
				<b>120</b>			
$V_S = 4\text{ V}$	120	130					
	<b>110</b>						
Input Capacitance	$C_{IN}$	Common Mode		3		$\text{pF}$	
EMI Rejection Ratio	EMIRR	$f = 5\text{ GHz}$		100		dB	
		$f = 400\text{ MHz}$		80			

## OUTPUT CHARACTERISTICS

Open Loop Voltage Gain	$A_{VOL}$	$V_{SS} + 0.5\text{ V} < V_O < V_{DD} - 0.5\text{ V}$	130	150		dB
			<b>125</b>	<b>135</b>		
Open Loop Output Impedance	$Z_{OUT\_OL}$	No Load		See Figure 23		$\Omega$
Output Voltage High, Referenced to Rail	$V_{OH}$	No Load		5	10	mV
		$R_L = 10\text{ k}\Omega$		100	210	
				<b>140</b>	<b>250</b>	
Output Voltage Low, Referenced to Rail	$V_{OL}$	No Load		5	10	mV
		$R_L = 10\text{ k}\Omega$		100	210	
				<b>140</b>	<b>250</b>	
Short Circuit Current	$I_{SC}$	Sinking Current		18		mA
		Sourcing Current		16		
Capacitive Load Drive	$C_L$			1		nF

## DYNAMIC PERFORMANCE

Gain Bandwidth Product	GBW	$C_L = 100\text{ pF}$		2		MHz
Gain Margin	$A_M$	$C_L = 100\text{ pF}$		13		dB
Phase Margin	$\phi_M$	$C_L = 100\text{ pF}$		55		$^\circ$
Slew Rate	SR	$G = +1$		1.6		$\text{V}/\mu\text{s}$
Settling Time	$t_S$	$V_S = 36\text{ V}$	0.1%	20		$\mu\text{s}$
			0.01%	45		$\mu\text{s}$
Overload Recovery Time	$t_{OR}$	$V_S = \pm 18\text{ V}$ , $A_V = -10$ , $V_{IN} = \pm 2.5\text{ V}$		1		$\mu\text{s}$

8. Guaranteed by characterization and/or design.

# NCS21911, NCV21911, NCS21912, NCV21912, NCS21914, NCV21914

## ELECTRICAL CHARACTERISTICS $V_S = 4\text{ V to }36\text{ V}$

At  $T_A = +25^\circ\text{C}$ ,  $R_L = 10\text{ k}\Omega$  connected to midsupply,  $V_{CM} = V_{OUT} = \text{midsupply}$ , unless otherwise noted.

**Boldface** limits apply over the specified temperature range,  $T_A = -40^\circ\text{C}$  to  $125^\circ\text{C}$ , guaranteed by characterization and/or design.

Parameter	Symbol	Conditions	Min	Typ	Max	Unit
-----------	--------	------------	-----	-----	-----	------

### NOISE PERFORMANCE

Total Harmonic Distortion + Noise	THD+N	$f_{IN} = 1\text{ kHz}$ , $A_V = 1$ , $V_{OUT} = 1\text{ V}_{rms}$		0.0003		%
Voltage Noise Density	$e_N$	$f = 1\text{ kHz}$		22		$\text{nV}/\sqrt{\text{Hz}}$
Current Noise Density	$i_N$	$f = 1\text{ kHz}$		100		$\text{fA}/\sqrt{\text{Hz}}$
Voltage Noise, Peak-to-Peak	$e_{pp}$	$f = 0.1\text{ Hz to }10\text{ Hz}$		400		$\text{nV}_{pp}$
Voltage Noise, RMS	$e_{rms}$	$f = 0.1\text{ Hz to }10\text{ Hz}$		70		$\text{nV}_{rms}$

### POWER SUPPLY

Power Supply Rejection Ratio	PSRR	$V_S = 4\text{ V to }36\text{ V}$		<b>0.02</b>	<b>0.3</b>	$\mu\text{V}/\text{V}$
			<b>130</b>	<b>154</b>		dB
Quiescent Current	$I_Q$	Per channel		475	570	$\mu\text{A}$
					<b>570</b>	

GRAPHS

Typical performance at  $T_A = 25^\circ\text{C}$ , unless otherwise noted.

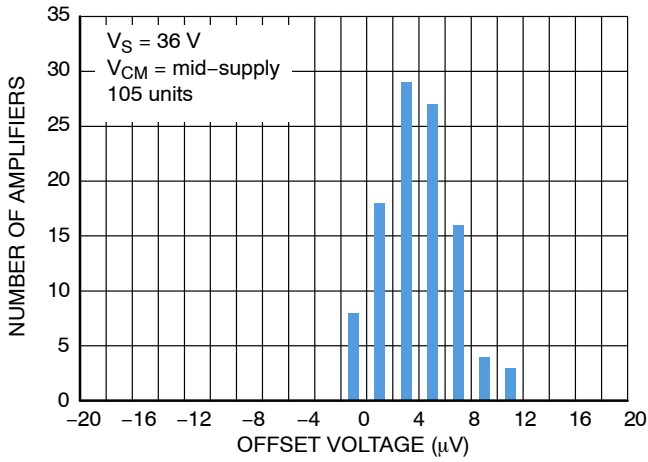

Figure 1. Offset Voltage Distribution

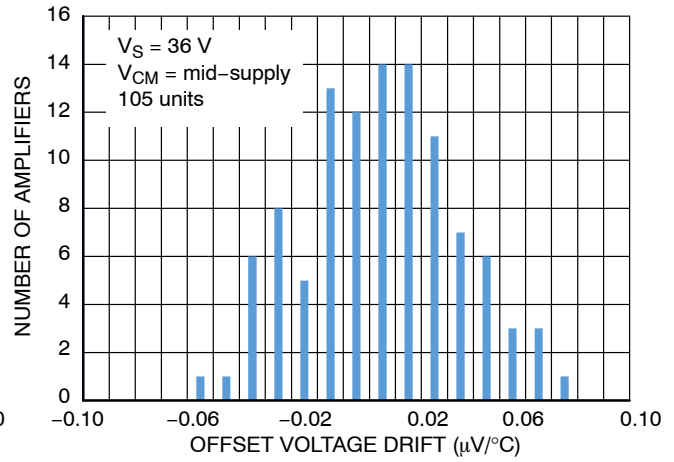

Figure 2. Offset Voltage Drift Distribution

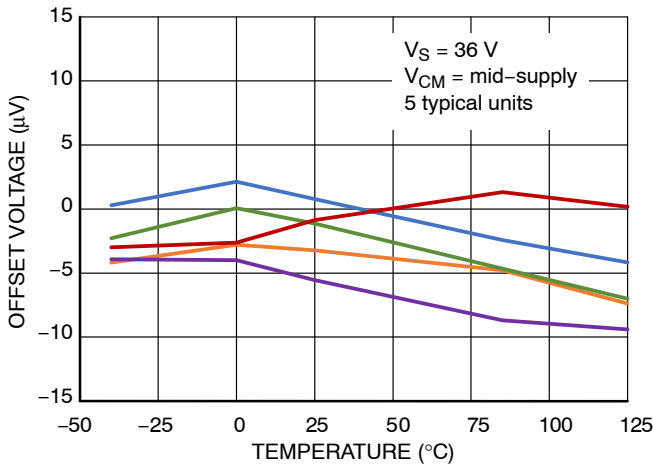

Figure 3. Offset Voltage vs. Temperature

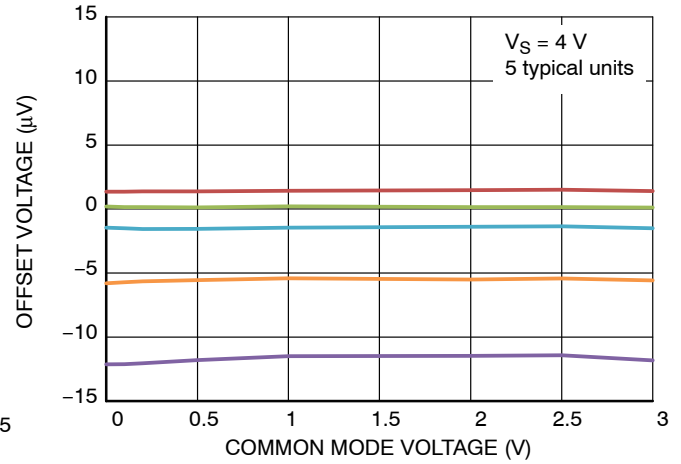

Figure 4. Offset Voltage vs. Common Mode Voltage

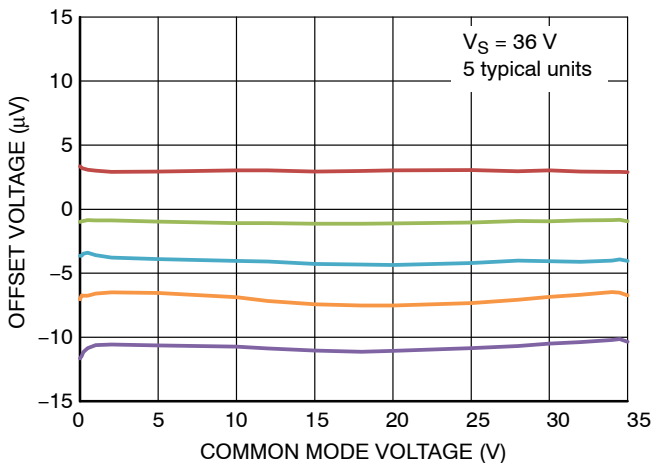

Figure 5. Offset Voltage vs. Common Mode Voltage

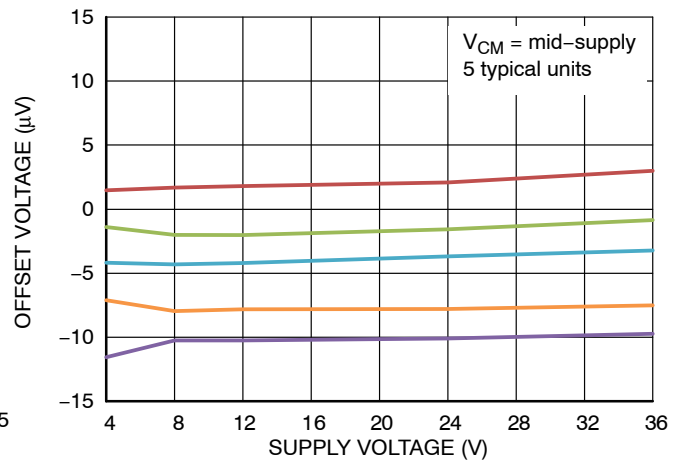

Figure 6. Offset Voltage vs. Power Supply

NCS21911, NCV21911, NCS21912, NCV21912, NCS21914, NCV21914

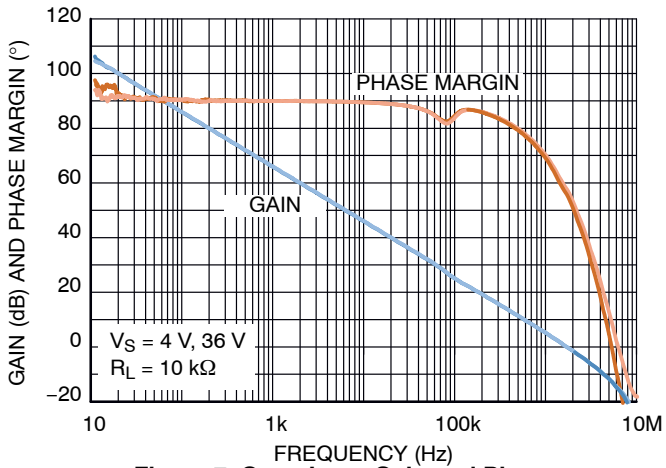

Figure 7. Open Loop Gain and Phase vs. Frequency

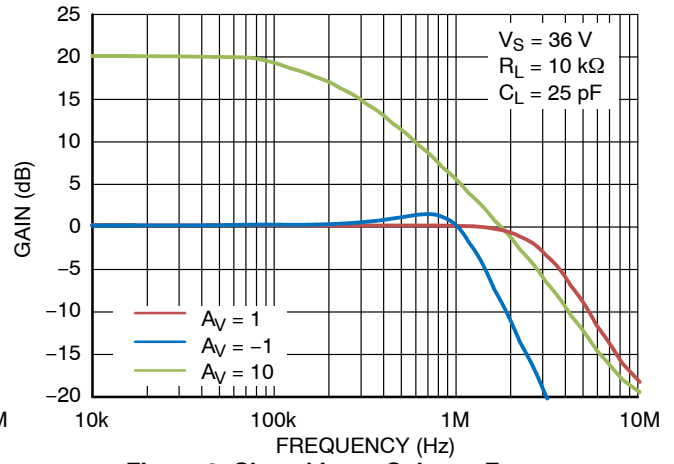

Figure 8. Closed Loop Gain vs. Frequency

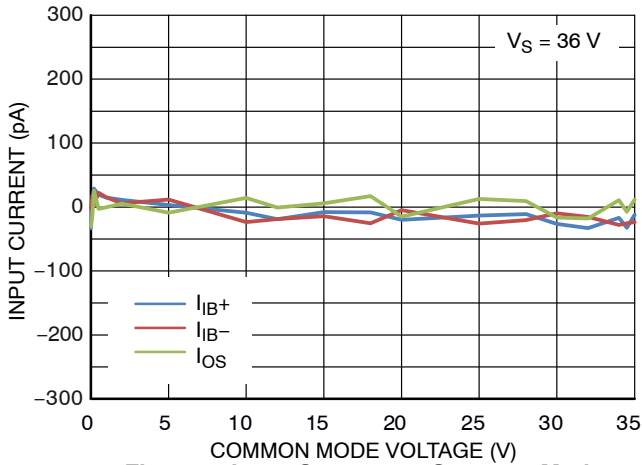

Figure 9. Input Current vs. Common Mode Voltage

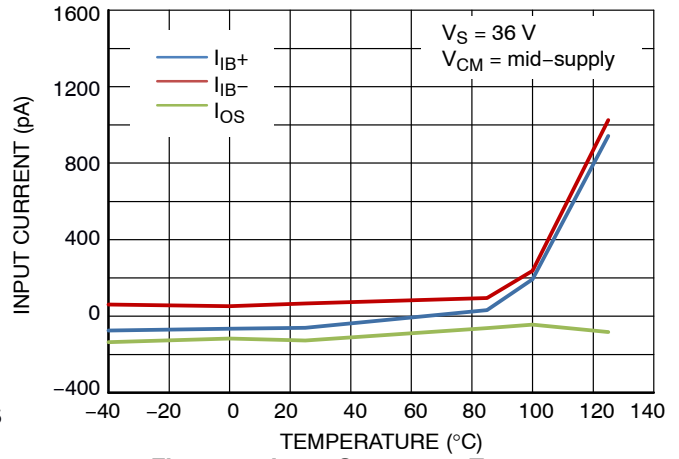

Figure 10. Input Current vs. Temperature

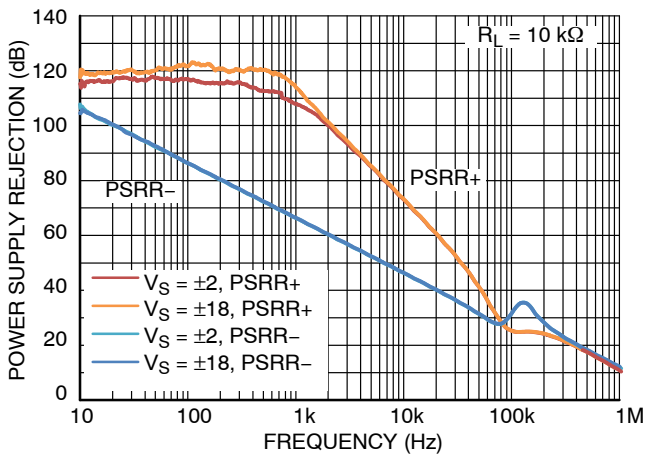

Figure 11. PSRR vs. Frequency

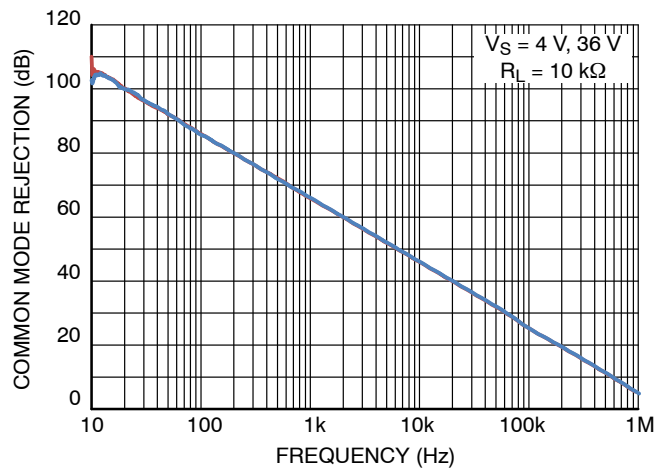

Figure 12. CMRR vs. Frequency

NCS21911, NCV21911, NCS21912, NCV21912, NCS21914, NCV21914

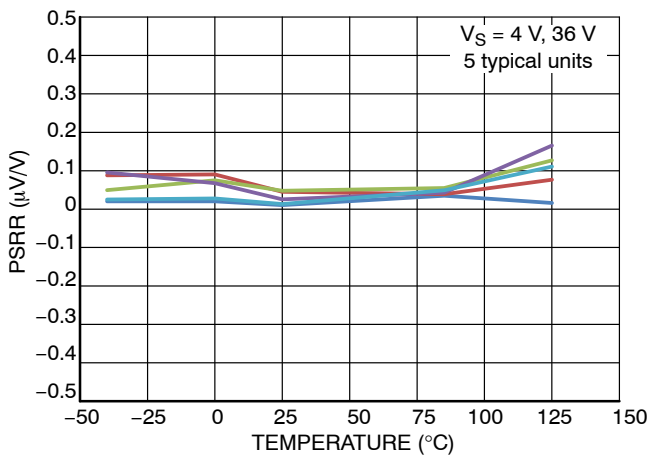

Figure 13. PSRR vs. Temperature

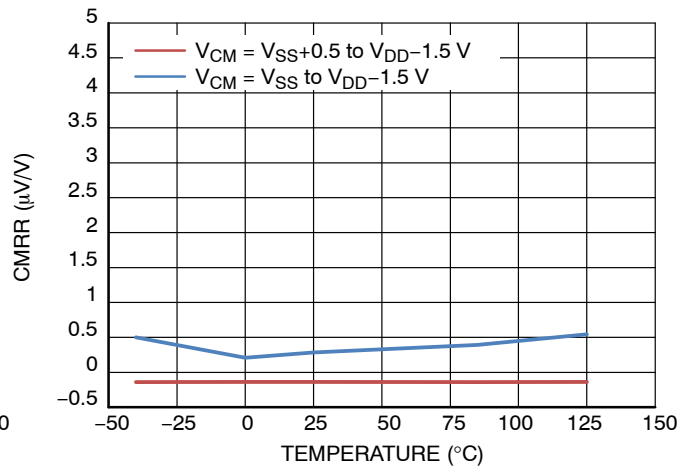

Figure 14. CMRR vs. Temperature at  $V_S = 4\text{ V}$

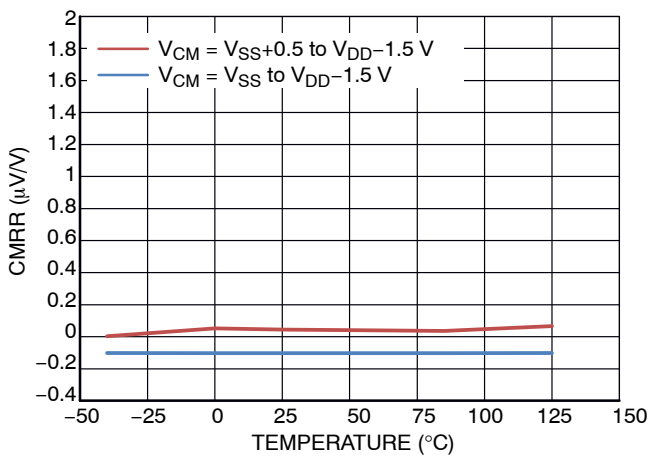

Figure 15. CMRR vs. Temperature at  $V_S = 36\text{ V}$

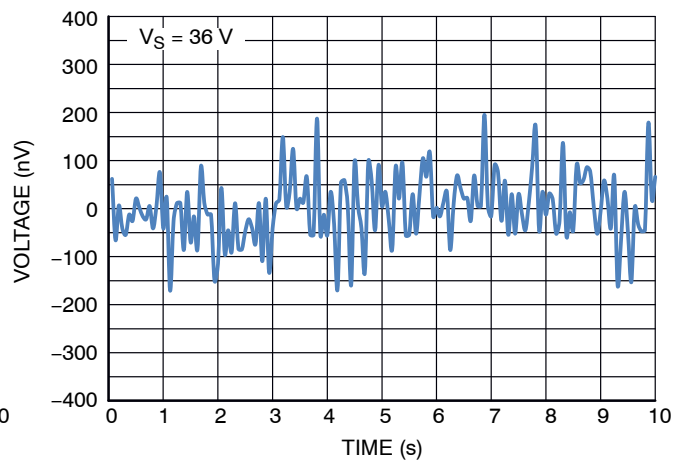

Figure 16. 0.1 Hz to 10 Hz Noise

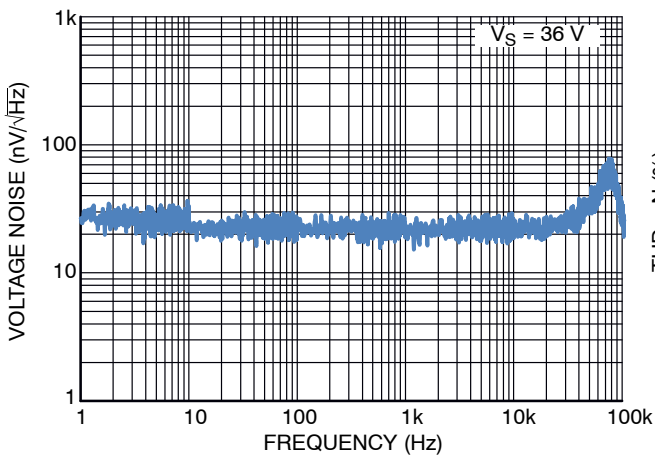

Figure 17. Voltage Noise Density vs. Frequency

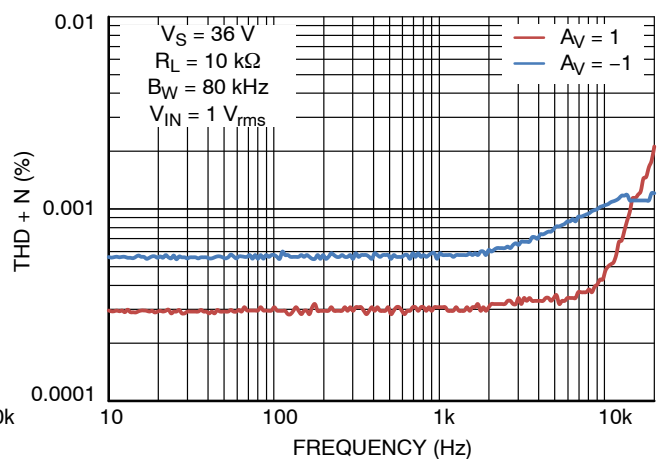

Figure 18. THD+N vs. Frequency



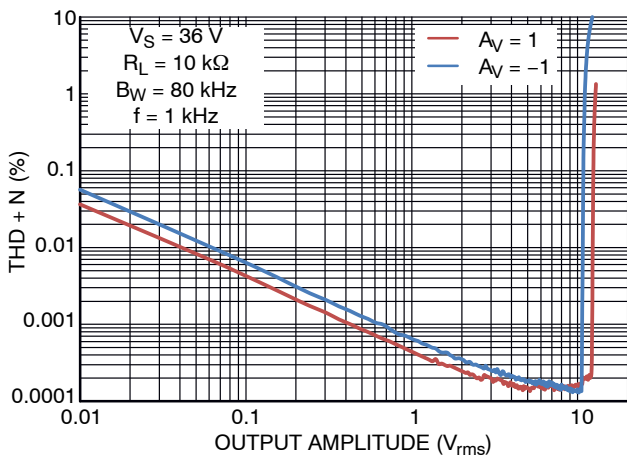

Figure 19. THD+N vs. Output Amplitude

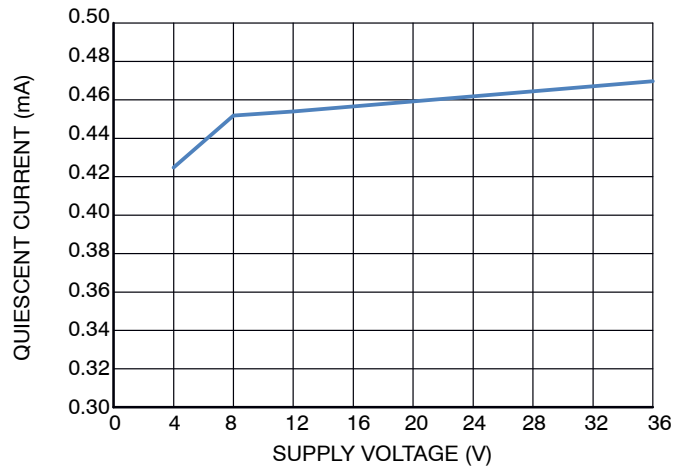

Figure 20. Quiescent Current vs. Supply Voltage

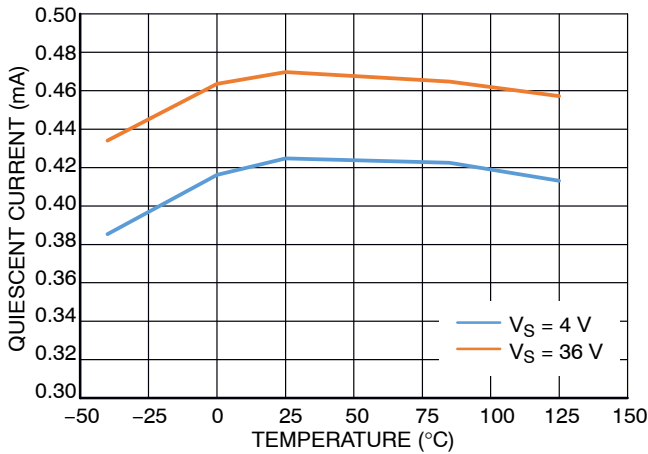

Figure 21. Quiescent Current vs. Temperature

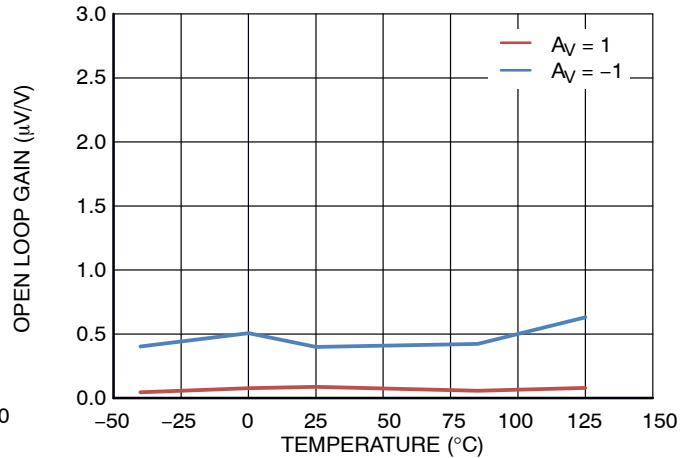

Figure 22. Open Loop Gain vs. Temperature

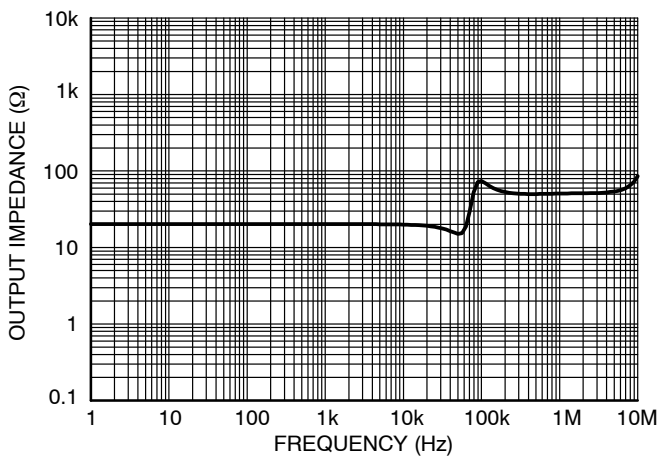

Figure 23. Open Loop Output Impedance vs. Frequency

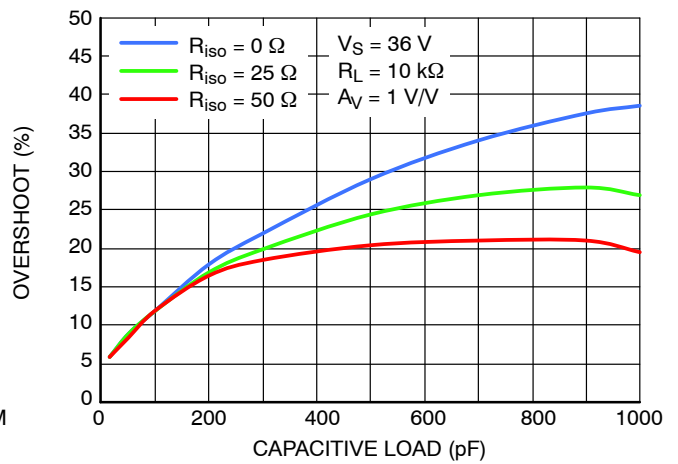

Figure 24. Small Signal Overshoot vs. Capacitive Load (100 mV Output Step)

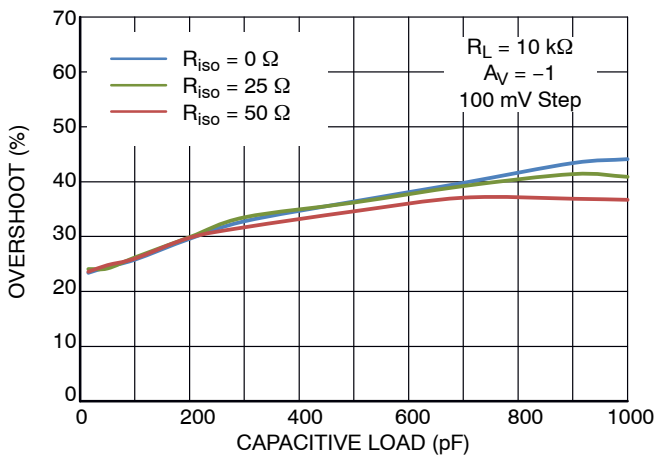

Figure 25. Small Signal Overshoot vs. Capacitive Load (100 mV Output Step)

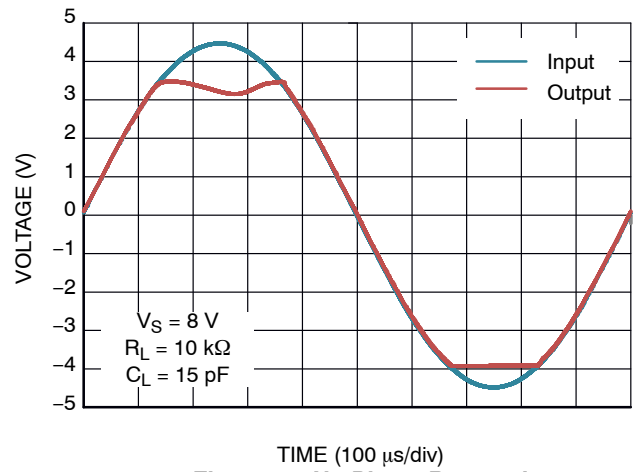

Figure 26. No Phase Reversal

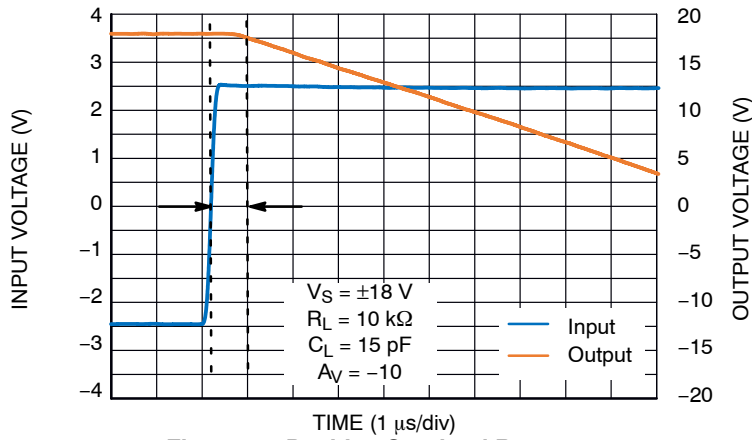

Figure 27. Positive Overload Recovery

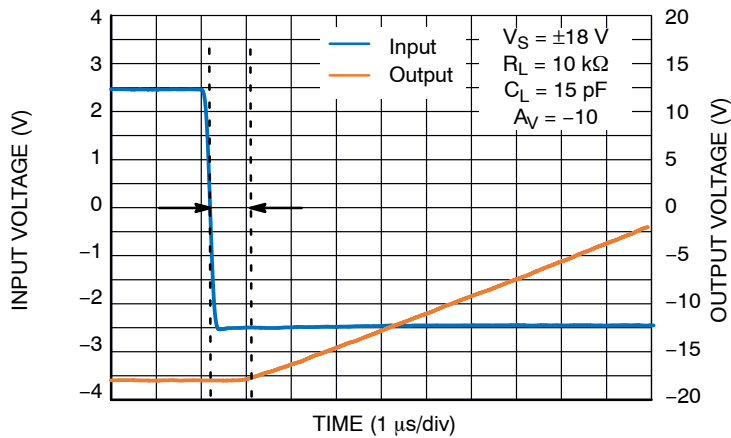

Figure 28. Negative Overload Recovery

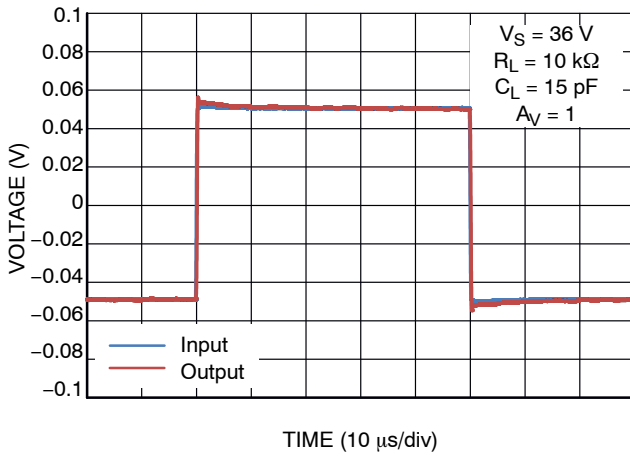

Figure 29. Non-Inverting Small Signal Step Response

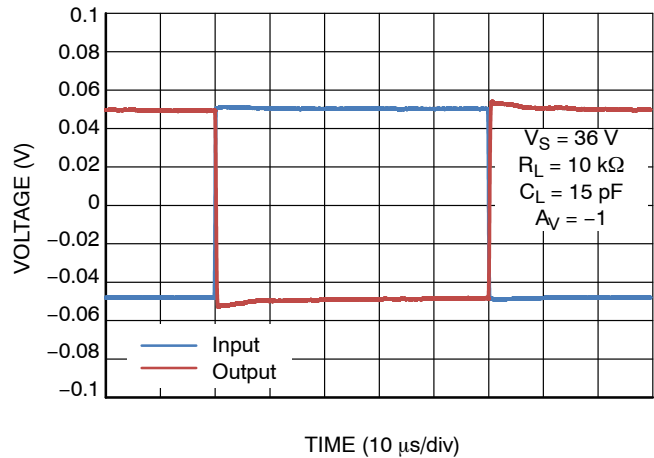

Figure 30. Inverting Small Signal Step Response

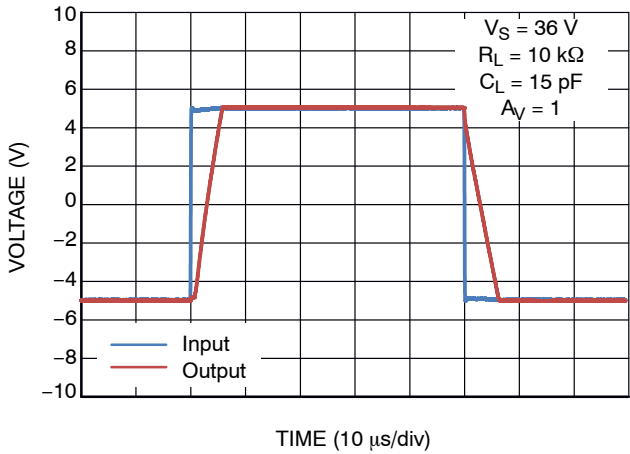

Figure 31. Non-Inverting Large Signal Step Response

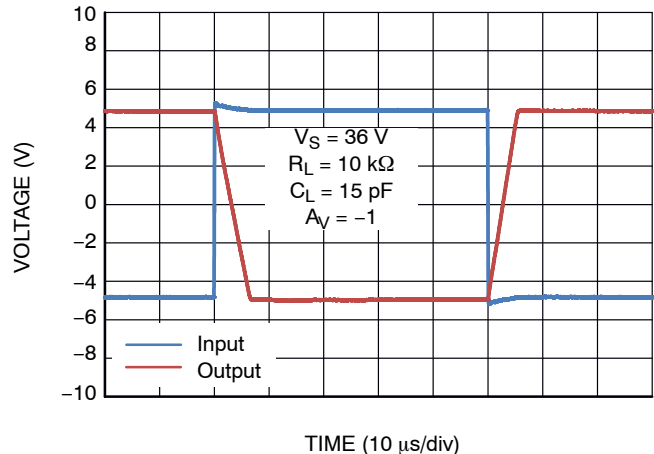

Figure 32. Inverting Large Signal Step Response

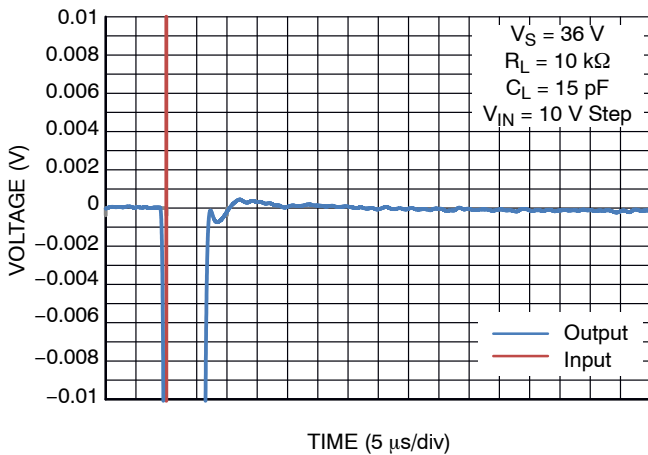

Figure 33. Large Signal Settling Time, Low-to-High

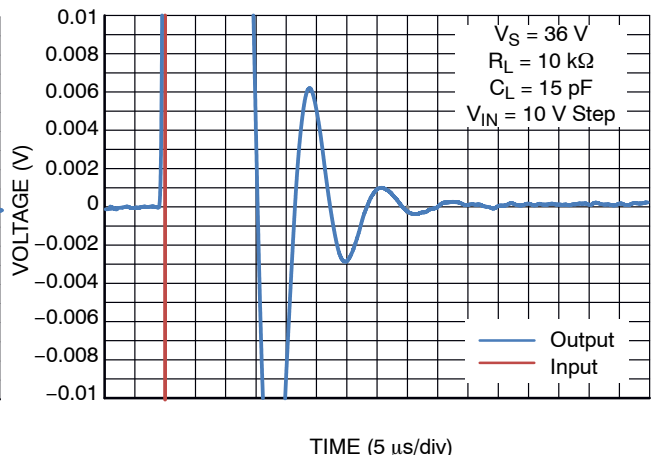

Figure 34. Large Signal Settling Time, High-to-Low

NCS21911, NCV21911, NCS21912, NCV21912, NCS21914, NCV21914

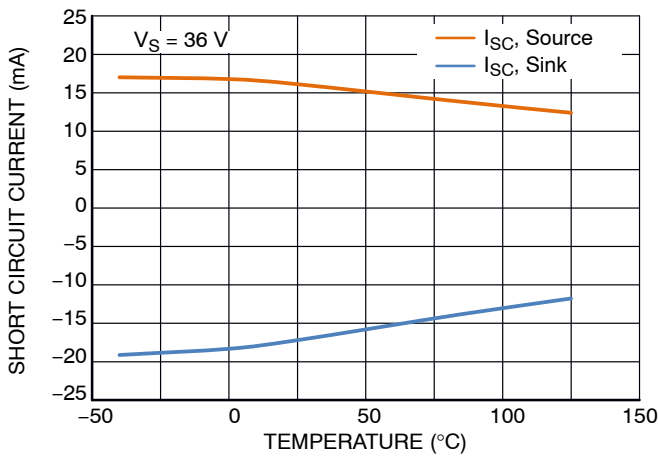

Figure 35. Short Circuit Current vs. Temperature

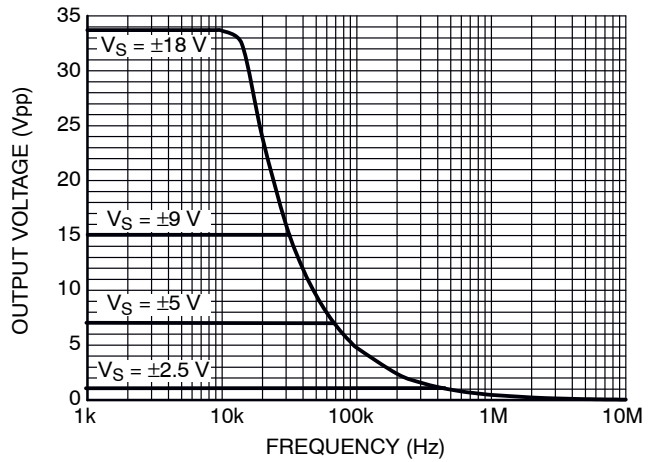

Figure 36. Maximum Output Voltage vs. Frequency ( $A_V = 1$  for  $V_S = \pm 2.5$  V,  $\pm 5$  V,  $\pm 9$  V;  $A_V = 2$  for  $V_S = \pm 18$  V)

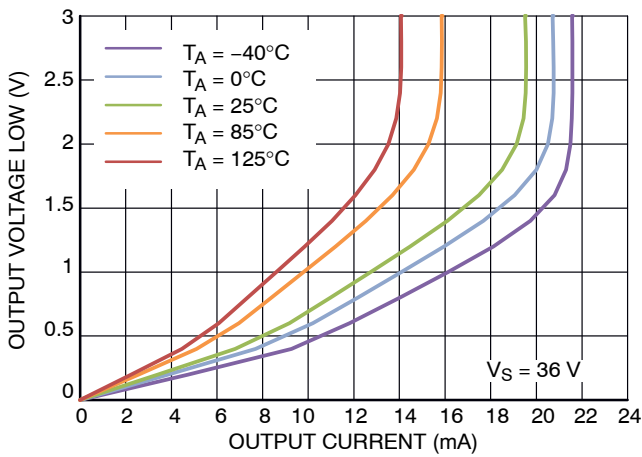

Figure 37. Output Voltage Low vs. Output Current

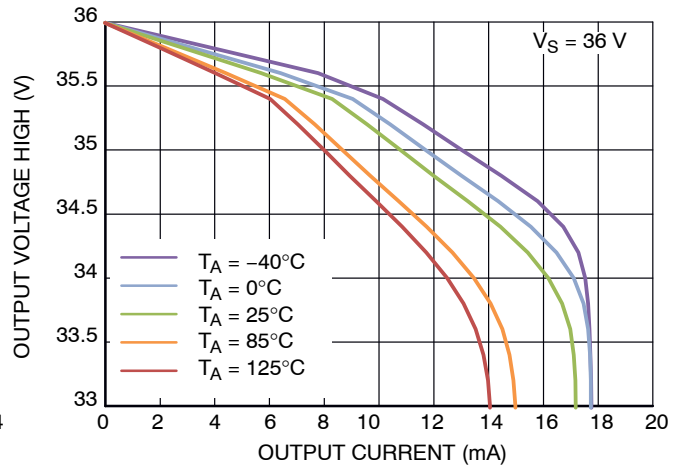

Figure 38. Output Voltage High vs. Output Current

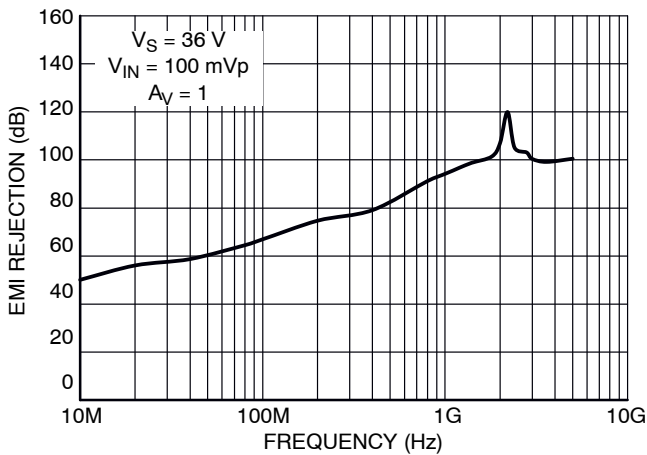

Figure 39. EMIRR IN+ vs. Frequency

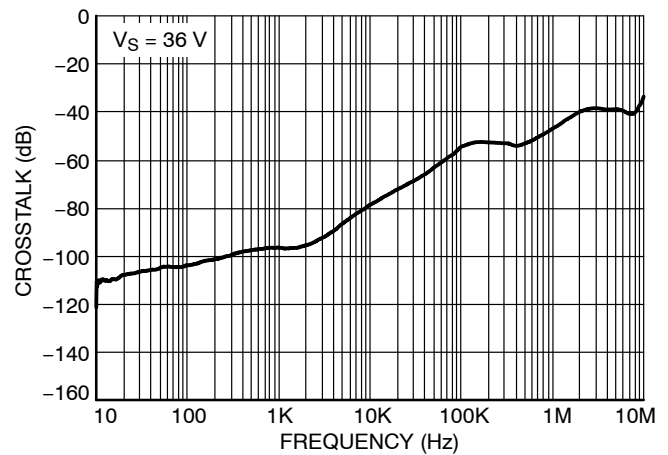

Figure 40. Channel-to-Channel Crosstalk

APPLICATION INFORMATION

Overview

The NCS21911, NCS21912, and NCS21914 precision op amps provide low offset voltage and zero drift over temperature. With a maximum offset voltage of 25  $\mu\text{V}$  and input common mode voltage range that includes ground, the NCS21911 series is well-suited for applications where precision is required, such as low side current sensing and interfacing with sensors.

The NCS21911 series of amplifiers uses a chopper-stabilized architecture, which provides the advantage of minimizing offset voltage drift over temperature and time. The simplified block diagram is shown in Figure 41. Unlike the classical chopper architecture, the chopper stabilized architecture has two signal paths.

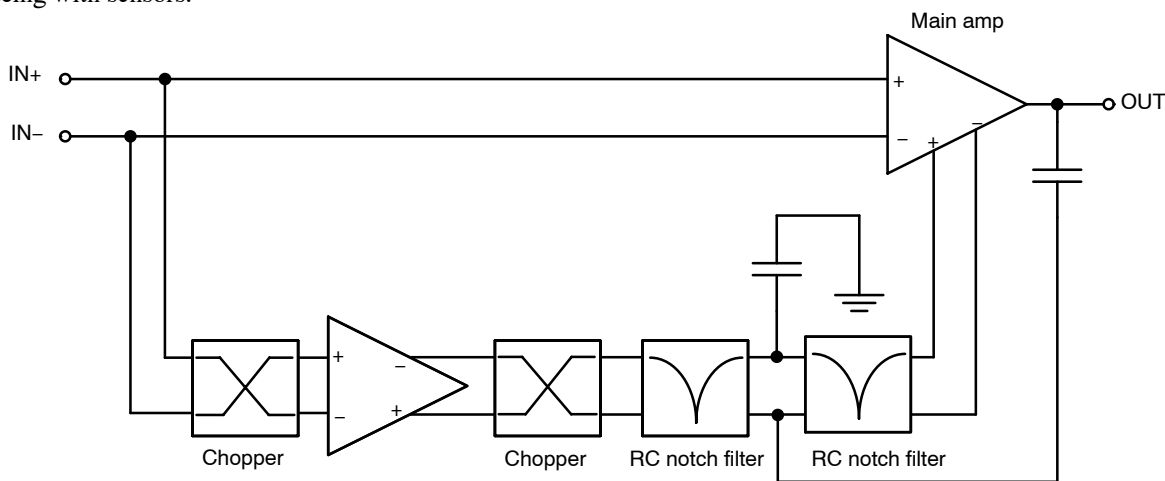

Figure 41. Simplified NCS21911 Block Diagram

In Figure 41, the lower signal path is where the chopper samples the input offset voltage, which is then used to correct the offset at the output. The offset correction occurs at a frequency of 250 kHz. The chopper-stabilized architecture is optimized for best performance at frequencies up to the related Nyquist frequency (1/2 of the offset correction frequency). As the signal frequency exceeds the Nyquist frequency, 125 kHz, aliasing may occur at the output. This is an inherent limitation of all chopper and chopper-stabilized architectures. Nevertheless, the NCS21911 series op amps have minimal aliasing up to 200 kHz and are less susceptible to aliasing effects when compared to competitor parts from other manufacturers. ON Semiconductor’s patented approach utilizes two cascaded, symmetrical, RC notch filters tuned to the chopper frequency and its fifth harmonic to reduce aliasing effects.

The chopper-stabilized architecture also benefits from the feed-forward path, which is shown as the upper signal path of the block diagram in Figure 41. This is the high speed signal path that extends the gain bandwidth up to 2 MHz. Not

only does this help retain high frequency components of the input signal, but it also improves the loop gain at low frequencies. This is especially useful for low-side current sensing and sensor interface applications where the signal is low frequency and the differential voltage is relatively small.

Application Circuits

Low-Side Current Sensing

Low-side current sensing is used to monitor the current through a load. This method can be used to detect over-current conditions and is often used in feedback control, as shown in Figure 42. A sense resistor is placed in series with the load to ground. Typically, the value of the sense resistor is less than 100 m $\Omega$  to reduce power loss across the resistor. The op amp amplifies the voltage drop across the sense resistor with a gain set by external resistors R1, R2, R3, and R4 (where R1 = R2, R3 = R4). Precision resistors are required for high accuracy, and the gain is set to utilize the full scale of the ADC for the highest resolution.

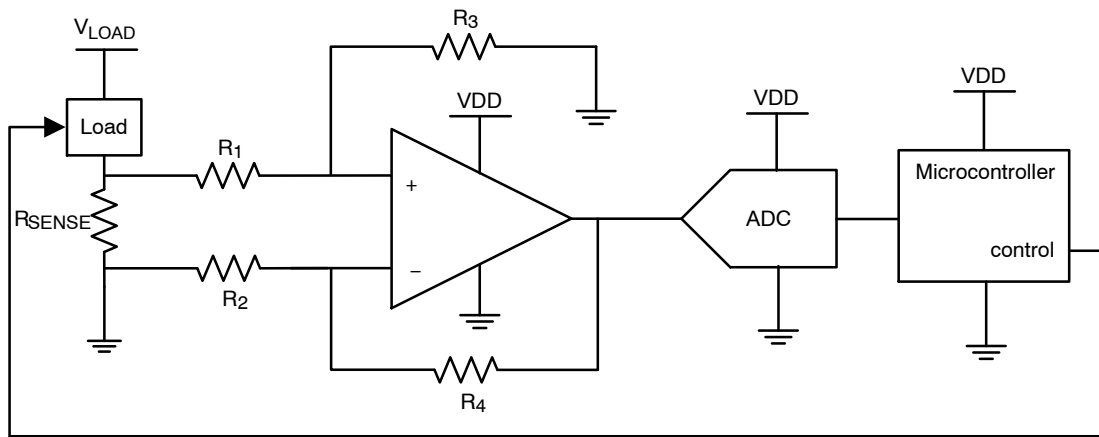

Figure 42. Low-Side Current Sensing

*Differential Amplifier for Bridged Circuits*

Sensors to measure strain, pressure, and temperature are often configured in a Wheatstone bridge circuit as shown in Figure 43. In the measurement, the voltage change that is

produced is relatively small and needs to be amplified before going into an ADC. Precision amplifiers are recommended in these types of applications due to their high gain, low noise, and low offset voltage.

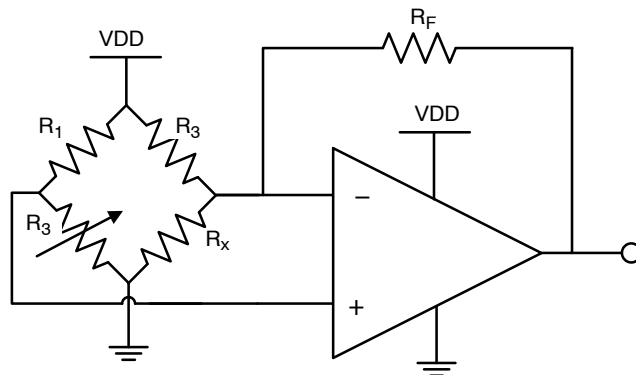

Figure 43. Wheatstone Bridge Circuit Amplification

**EMI Susceptibility and Input Filtering**

Op amps have varying amounts of EMI susceptibility. Semiconductor junctions can pick up and rectify EMI signals, creating an EMI-induced voltage offset at the output, adding another component to the total error. Input pins are the most sensitive to EMI. The NCS2191x integrates low-pass filters to decrease its sensitivity to EMI. Figure 39 shows the EMIRR performance.

**General Layout Guidelines**

To ensure optimum device performance, it is important to follow good PCB design practices. Place 0.1  $\mu$ F decoupling

capacitors as close as possible to the supply pins. Keep traces short, utilize a ground plane, choose surface-mount components, and place components as close as possible to the device pins. These techniques will reduce susceptibility to electromagnetic interference (EMI). Thermoelectric effects can create an additional temperature dependent offset voltage at the input pins. To reduce these effects, use metals with low thermoelectric coefficients and prevent temperature gradients from heat sources or cooling fans.

# MECHANICAL CASE OUTLINE

## PACKAGE DIMENSIONS

ON Semiconductor®



SCALE 2:1

### TSOP-5 CASE 483 ISSUE N

DATE 12 AUG 2020

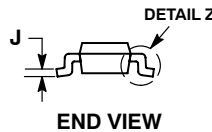
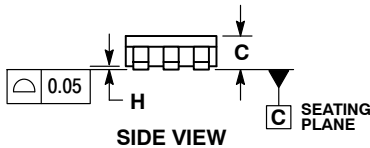

NOTES:

1. DIMENSIONING AND TOLERANCING PER ASME Y14.5M, 1994.
2. CONTROLLING DIMENSION: MILLIMETERS.
3. MAXIMUM LEAD THICKNESS INCLUDES LEAD FINISH THICKNESS. MINIMUM LEAD THICKNESS IS THE MINIMUM THICKNESS OF BASE MATERIAL.
4. DIMENSIONS A AND B DO NOT INCLUDE MOLD FLASH, PROTRUSIONS, OR GATE BURRS. MOLD FLASH, PROTRUSIONS, OR GATE BURRS SHALL NOT EXCEED 0.15 PER SIDE. DIMENSION A.
5. OPTIONAL CONSTRUCTION: AN ADDITIONAL TRIMMED LEAD IS ALLOWED IN THIS LOCATION. TRIMMED LEAD NOT TO EXTEND MORE THAN 0.2 FROM BODY.

DIM	MILLIMETERS	
	MIN	MAX
A	2.85	3.15
B	1.35	1.65
C	0.90	1.10
D	0.25	0.50
G	0.95 BSC	
H	0.01	0.10
J	0.10	0.26
K	0.20	0.60
M	0°	10°
S	2.50	3.00

#### SOLDERING FOOTPRINT\*



\*For additional information on our Pb-Free strategy and soldering details, please download the ON Semiconductor Soldering and Mounting Techniques Reference Manual, SOLDERRM/D.

#### GENERIC MARKING DIAGRAM\*



- XXX = Specific Device Code  
 A = Assembly Location  
 Y = Year  
 W = Work Week  
 ■ = Pb-Free Package
- XXX = Specific Device Code  
 M = Date Code  
 ■ = Pb-Free Package

(Note: Microdot may be in either location)

\*This information is generic. Please refer to device data sheet for actual part marking. Pb-Free indicator, "G" or microdot "■", may or may not be present.

DOCUMENT NUMBER:	98ARB18753C	Electronic versions are uncontrolled except when accessed directly from the Document Repository. Printed versions are uncontrolled except when stamped "CONTROLLED COPY" in red.
DESCRIPTION:	TSOP-5	PAGE 1 OF 1

ON Semiconductor and ON are trademarks of Semiconductor Components Industries, LLC dba ON Semiconductor or its subsidiaries in the United States and/or other countries. ON Semiconductor reserves the right to make changes without further notice to any products herein. ON Semiconductor makes no warranty, representation or guarantee regarding the suitability of its products for any particular purpose, nor does ON Semiconductor assume any liability arising out of the application or use of any product or circuit, and specifically disclaims any and all liability, including without limitation special, consequential or incidental damages. ON Semiconductor does not convey any license under its patent rights nor the rights of others.

# MECHANICAL CASE OUTLINE PACKAGE DIMENSIONS

ON Semiconductor®



SCALE 1:1

SOIC-8 NB  
CASE 751-07  
ISSUE AK

DATE 16 FEB 2011



- NOTES:
1. DIMENSIONING AND TOLERANCING PER ANSI Y14.5M, 1982.
  2. CONTROLLING DIMENSION: MILLIMETER.
  3. DIMENSION A AND B DO NOT INCLUDE MOLD PROTRUSION.
  4. MAXIMUM MOLD PROTRUSION 0.15 (0.006) PER SIDE.
  5. DIMENSION D DOES NOT INCLUDE DAMBAR PROTRUSION. ALLOWABLE DAMBAR PROTRUSION SHALL BE 0.127 (0.005) TOTAL IN EXCESS OF THE D DIMENSION AT MAXIMUM MATERIAL CONDITION.
  6. 751-01 THRU 751-06 ARE OBSOLETE. NEW STANDARD IS 751-07.

DIM	MILLIMETERS		INCHES	
	MIN	MAX	MIN	MAX
A	4.80	5.00	0.189	0.197
B	3.80	4.00	0.150	0.157
C	1.35	1.75	0.053	0.069
D	0.33	0.51	0.013	0.020
G	1.27 BSC		0.050 BSC	
H	0.10	0.25	0.004	0.010
J	0.19	0.25	0.007	0.010
K	0.40	1.27	0.016	0.050
M	0°	8°	0°	8°
N	0.25	0.50	0.010	0.020
S	5.80	6.20	0.228	0.244

### SOLDERING FOOTPRINT\*



\*For additional information on our Pb-Free strategy and soldering details, please download the ON Semiconductor Soldering and Mounting Techniques Reference Manual, SOLDERRM/D.

### GENERIC MARKING DIAGRAM\*



XXXXXX = Specific Device Code  
 A = Assembly Location  
 L = Wafer Lot  
 Y = Year  
 W = Work Week  
 ■ = Pb-Free Package

XXXXXX = Specific Device Code  
 A = Assembly Location  
 Y = Year  
 WW = Work Week  
 ■ = Pb-Free Package

\*This information is generic. Please refer to device data sheet for actual part marking. Pb-Free indicator, "G" or microdot "•", may or may not be present. Some products may not follow the Generic Marking.

STYLES ON PAGE 2

DOCUMENT NUMBER:	98ASB42564B	Electronic versions are uncontrolled except when accessed directly from the Document Repository. Printed versions are uncontrolled except when stamped "CONTROLLED COPY" in red.
DESCRIPTION:	SOIC-8 NB	PAGE 1 OF 2

ON Semiconductor and ON are trademarks of Semiconductor Components Industries, LLC dba ON Semiconductor or its subsidiaries in the United States and/or other countries. ON Semiconductor reserves the right to make changes without further notice to any products herein. ON Semiconductor makes no warranty, representation or guarantee regarding the suitability of its products for any particular purpose, nor does ON Semiconductor assume any liability arising out of the application or use of any product or circuit, and specifically disclaims any and all liability, including without limitation special, consequential or incidental damages. ON Semiconductor does not convey any license under its patent rights nor the rights of others.



**SOIC-8 NB**  
**CASE 751-07**  
**ISSUE AK**

DATE 16 FEB 2011

- |  |   |   |   |
|--|---|---|---|
| <p><b>STYLE 1:</b><br/> PIN 1. EMITTER<br/> 2. COLLECTOR<br/> 3. COLLECTOR<br/> 4. EMITTER<br/> 5. EMITTER<br/> 6. BASE<br/> 7. BASE<br/> 8. EMITTER</p>   | <p><b>STYLE 2:</b><br/> PIN 1. COLLECTOR, DIE, #1<br/> 2. COLLECTOR, #1<br/> 3. COLLECTOR, #2<br/> 4. COLLECTOR, #2<br/> 5. BASE, #2<br/> 6. EMITTER, #2<br/> 7. BASE, #1<br/> 8. EMITTER, #1</p>               | <p><b>STYLE 3:</b><br/> PIN 1. DRAIN, DIE #1<br/> 2. DRAIN, #1<br/> 3. DRAIN, #2<br/> 4. DRAIN, #2<br/> 5. GATE, #2<br/> 6. SOURCE, #2<br/> 7. GATE, #1<br/> 8. SOURCE, #1</p>                            | <p><b>STYLE 4:</b><br/> PIN 1. ANODE<br/> 2. ANODE<br/> 3. ANODE<br/> 4. ANODE<br/> 5. ANODE<br/> 6. ANODE<br/> 7. ANODE<br/> 8. COMMON CATHODE</p>   |
| <p><b>STYLE 5:</b><br/> PIN 1. DRAIN<br/> 2. DRAIN<br/> 3. DRAIN<br/> 4. DRAIN<br/> 5. GATE<br/> 6. GATE<br/> 7. SOURCE<br/> 8. SOURCE</p>   | <p><b>STYLE 6:</b><br/> PIN 1. SOURCE<br/> 2. DRAIN<br/> 3. DRAIN<br/> 4. SOURCE<br/> 5. SOURCE<br/> 6. GATE<br/> 7. GATE<br/> 8. SOURCE</p>  | <p><b>STYLE 7:</b><br/> PIN 1. INPUT<br/> 2. EXTERNAL BYPASS<br/> 3. THIRD STAGE SOURCE<br/> 4. GROUND<br/> 5. DRAIN<br/> 6. GATE 3<br/> 7. SECOND STAGE Vd<br/> 8. FIRST STAGE Vd</p>                    | <p><b>STYLE 8:</b><br/> PIN 1. COLLECTOR, DIE #1<br/> 2. BASE, #1<br/> 3. BASE, #2<br/> 4. COLLECTOR, #2<br/> 5. COLLECTOR, #2<br/> 6. EMITTER, #2<br/> 7. EMITTER, #1<br/> 8. COLLECTOR, #1</p>                              |
| <p><b>STYLE 9:</b><br/> PIN 1. EMITTER, COMMON<br/> 2. COLLECTOR, DIE #1<br/> 3. COLLECTOR, DIE #2<br/> 4. EMITTER, COMMON<br/> 5. EMITTER, COMMON<br/> 6. BASE, DIE #2<br/> 7. BASE, DIE #1<br/> 8. EMITTER, COMMON</p> | <p><b>STYLE 10:</b><br/> PIN 1. GROUND<br/> 2. BIAS 1<br/> 3. OUTPUT<br/> 4. GROUND<br/> 5. GROUND<br/> 6. BIAS 2<br/> 7. INPUT<br/> 8. GROUND</p>  | <p><b>STYLE 11:</b><br/> PIN 1. SOURCE 1<br/> 2. GATE 1<br/> 3. SOURCE 2<br/> 4. GATE 2<br/> 5. DRAIN 2<br/> 6. DRAIN 2<br/> 7. DRAIN 1<br/> 8. DRAIN 1</p>   | <p><b>STYLE 12:</b><br/> PIN 1. SOURCE<br/> 2. SOURCE<br/> 3. SOURCE<br/> 4. GATE<br/> 5. DRAIN<br/> 6. DRAIN<br/> 7. DRAIN<br/> 8. DRAIN</p>   |
| <p><b>STYLE 13:</b><br/> PIN 1. N.C.<br/> 2. SOURCE<br/> 3. SOURCE<br/> 4. GATE<br/> 5. DRAIN<br/> 6. DRAIN<br/> 7. DRAIN<br/> 8. DRAIN</p>  | <p><b>STYLE 14:</b><br/> PIN 1. N-SOURCE<br/> 2. N-GATE<br/> 3. P-SOURCE<br/> 4. P-GATE<br/> 5. P-DRAIN<br/> 6. P-DRAIN<br/> 7. N-DRAIN<br/> 8. N-DRAIN</p>   | <p><b>STYLE 15:</b><br/> PIN 1. ANODE 1<br/> 2. ANODE 1<br/> 3. ANODE 1<br/> 4. ANODE 1<br/> 5. CATHODE, COMMON<br/> 6. CATHODE, COMMON<br/> 7. CATHODE, COMMON<br/> 8. CATHODE, COMMON</p>               | <p><b>STYLE 16:</b><br/> PIN 1. EMITTER, DIE #1<br/> 2. BASE, DIE #1<br/> 3. EMITTER, DIE #2<br/> 4. BASE, DIE #2<br/> 5. COLLECTOR, DIE #2<br/> 6. COLLECTOR, DIE #2<br/> 7. COLLECTOR, DIE #1<br/> 8. COLLECTOR, DIE #1</p> |
| <p><b>STYLE 17:</b><br/> PIN 1. VCC<br/> 2. V2OUT<br/> 3. V1OUT<br/> 4. TXE<br/> 5. RXE<br/> 6. VEE<br/> 7. GND<br/> 8. ACC</p>  | <p><b>STYLE 18:</b><br/> PIN 1. ANODE<br/> 2. ANODE<br/> 3. SOURCE<br/> 4. GATE<br/> 5. DRAIN<br/> 6. DRAIN<br/> 7. CATHODE<br/> 8. CATHODE</p>   | <p><b>STYLE 19:</b><br/> PIN 1. SOURCE 1<br/> 2. GATE 1<br/> 3. SOURCE 2<br/> 4. GATE 2<br/> 5. DRAIN 2<br/> 6. MIRROR 2<br/> 7. DRAIN 1<br/> 8. MIRROR 1</p>   | <p><b>STYLE 20:</b><br/> PIN 1. SOURCE (N)<br/> 2. GATE (N)<br/> 3. SOURCE (P)<br/> 4. GATE (P)<br/> 5. DRAIN<br/> 6. DRAIN<br/> 7. DRAIN<br/> 8. DRAIN</p>   |
| <p><b>STYLE 21:</b><br/> PIN 1. CATHODE 1<br/> 2. CATHODE 2<br/> 3. CATHODE 3<br/> 4. CATHODE 4<br/> 5. CATHODE 5<br/> 6. COMMON ANODE<br/> 7. COMMON ANODE<br/> 8. CATHODE 6</p>  | <p><b>STYLE 22:</b><br/> PIN 1. I/O LINE 1<br/> 2. COMMON CATHODE/VCC<br/> 3. COMMON CATHODE/VCC<br/> 4. I/O LINE 3<br/> 5. COMMON ANODE/GND<br/> 6. I/O LINE 4<br/> 7. I/O LINE 5<br/> 8. COMMON ANODE/GND</p> | <p><b>STYLE 23:</b><br/> PIN 1. LINE 1 IN<br/> 2. COMMON ANODE/GND<br/> 3. COMMON ANODE/GND<br/> 4. LINE 2 IN<br/> 5. LINE 2 OUT<br/> 6. COMMON ANODE/GND<br/> 7. COMMON ANODE/GND<br/> 8. LINE 1 OUT</p> | <p><b>STYLE 24:</b><br/> PIN 1. BASE<br/> 2. EMITTER<br/> 3. COLLECTOR/ANODE<br/> 4. COLLECTOR/ANODE<br/> 5. CATHODE<br/> 6. CATHODE<br/> 7. COLLECTOR/ANODE<br/> 8. COLLECTOR/ANODE</p>                                      |
| <p><b>STYLE 25:</b><br/> PIN 1. VIN<br/> 2. N/C<br/> 3. REXT<br/> 4. GND<br/> 5. IOUT<br/> 6. IOUT<br/> 7. IOUT<br/> 8. IOUT</p>   | <p><b>STYLE 26:</b><br/> PIN 1. GND<br/> 2. dv/dt<br/> 3. ENABLE<br/> 4. ILIMIT<br/> 5. SOURCE<br/> 6. SOURCE<br/> 7. SOURCE<br/> 8. VCC</p>  | <p><b>STYLE 27:</b><br/> PIN 1. ILIMIT<br/> 2. OVLO<br/> 3. UVLO<br/> 4. INPUT+<br/> 5. SOURCE<br/> 6. SOURCE<br/> 7. SOURCE<br/> 8. DRAIN</p>  | <p><b>STYLE 28:</b><br/> PIN 1. SW_TO_GND<br/> 2. DASIC OFF<br/> 3. DASIC_SW_DET<br/> 4. GND<br/> 5. V_MON<br/> 6. VBULK<br/> 7. VBULK<br/> 8. VIN</p>  |
| <p><b>STYLE 29:</b><br/> PIN 1. BASE, DIE #1<br/> 2. EMITTER, #1<br/> 3. BASE, #2<br/> 4. EMITTER, #2<br/> 5. COLLECTOR, #2<br/> 6. COLLECTOR, #2<br/> 7. COLLECTOR, #1<br/> 8. COLLECTOR, #1</p>                        | <p><b>STYLE 30:</b><br/> PIN 1. DRAIN 1<br/> 2. DRAIN 1<br/> 3. GATE 2<br/> 4. SOURCE 2<br/> 5. SOURCE 1/DRAIN 2<br/> 6. SOURCE 1/DRAIN 2<br/> 7. SOURCE 1/DRAIN 2<br/> 8. GATE 1</p>                           |   |   |

<b>DOCUMENT NUMBER:</b>	<b>98ASB42564B</b>	Electronic versions are uncontrolled except when accessed directly from the Document Repository. Printed versions are uncontrolled except when stamped "CONTROLLED COPY" in red.
<b>DESCRIPTION:</b>	<b>SOIC-8 NB</b>	<b>PAGE 2 OF 2</b>

ON Semiconductor and  are trademarks of Semiconductor Components Industries, LLC dba ON Semiconductor or its subsidiaries in the United States and/or other countries. ON Semiconductor reserves the right to make changes without further notice to any products herein. ON Semiconductor makes no warranty, representation or guarantee regarding the suitability of its products for any particular purpose, nor does ON Semiconductor assume any liability arising out of the application or use of any product or circuit, and specifically disclaims any and all liability, including without limitation special, consequential or incidental damages. ON Semiconductor does not convey any license under its patent rights nor the rights of others.

# MECHANICAL CASE OUTLINE PACKAGE DIMENSIONS

ON Semiconductor®



SCALE 1:1

SOIC-14 NB  
CASE 751A-03  
ISSUE L

DATE 03 FEB 2016

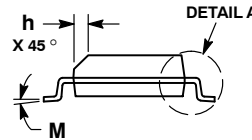
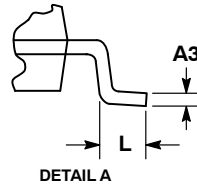

- NOTES:
1. DIMENSIONING AND TOLERANCING PER ASME Y14.5M, 1994.
  2. CONTROLLING DIMENSION: MILLIMETERS.
  3. DIMENSION b DOES NOT INCLUDE DAMBAR PROTRUSION. ALLOWABLE PROTRUSION SHALL BE 0.13 TOTAL IN EXCESS OF AT MAXIMUM MATERIAL CONDITION.
  4. DIMENSIONS D AND E DO NOT INCLUDE MOLD PROTRUSIONS.
  5. MAXIMUM MOLD PROTRUSION 0.15 PER SIDE.

DIM	MILLIMETERS		INCHES	
	MIN	MAX	MIN	MAX
A	1.35	1.75	0.054	0.068
A1	0.10	0.25	0.004	0.010
A3	0.19	0.25	0.008	0.010
b	0.35	0.49	0.014	0.019
D	8.55	8.75	0.337	0.344
E	3.80	4.00	0.150	0.157
e	1.27 BSC		0.050 BSC	
H	5.80	6.20	0.228	0.244
h	0.25	0.50	0.010	0.019
L	0.40	1.25	0.016	0.049
M	0°	7°	0°	7°

### SOLDERING FOOTPRINT\*



DIMENSIONS: MILLIMETERS

\*For additional information on our Pb-Free strategy and soldering details, please download the ON Semiconductor Soldering and Mounting Techniques Reference Manual, SOLDERRM/D.

### GENERIC MARKING DIAGRAM\*



- XXXXXX = Specific Device Code
- A = Assembly Location
- WL = Wafer Lot
- Y = Year
- WW = Work Week
- G = Pb-Free Package

\*This information is generic. Please refer to device data sheet for actual part marking. Pb-Free indicator, "G" or microdot "▪", may or may not be present.

### STYLES ON PAGE 2

DOCUMENT NUMBER:	98ASB42565B	Electronic versions are uncontrolled except when accessed directly from the Document Repository. Printed versions are uncontrolled except when stamped "CONTROLLED COPY" in red.
DESCRIPTION:	SOIC-14 NB	PAGE 1 OF 2

ON Semiconductor and ON are trademarks of Semiconductor Components Industries, LLC dba ON Semiconductor or its subsidiaries in the United States and/or other countries. ON Semiconductor reserves the right to make changes without further notice to any products herein. ON Semiconductor makes no warranty, representation or guarantee regarding the suitability of its products for any particular purpose, nor does ON Semiconductor assume any liability arising out of the application or use of any product or circuit, and specifically disclaims any and all liability, including without limitation special, consequential or incidental damages. ON Semiconductor does not convey any license under its patent rights nor the rights of others.

**SOIC-14**  
**CASE 751A-03**  
**ISSUE L**

DATE 03 FEB 2016

STYLE 1:  
 PIN 1. COMMON CATHODE  
 2. ANODE/CATHODE  
 3. ANODE/CATHODE  
 4. NO CONNECTION  
 5. ANODE/CATHODE  
 6. NO CONNECTION  
 7. ANODE/CATHODE  
 8. ANODE/CATHODE  
 9. ANODE/CATHODE  
 10. NO CONNECTION  
 11. ANODE/CATHODE  
 12. ANODE/CATHODE  
 13. NO CONNECTION  
 14. COMMON ANODE

STYLE 2:  
 CANCELLED

STYLE 3:  
 PIN 1. NO CONNECTION  
 2. ANODE  
 3. ANODE  
 4. NO CONNECTION  
 5. ANODE  
 6. NO CONNECTION  
 7. ANODE  
 8. ANODE  
 9. ANODE  
 10. NO CONNECTION  
 11. ANODE  
 12. ANODE  
 13. NO CONNECTION  
 14. COMMON CATHODE

STYLE 4:  
 PIN 1. NO CONNECTION  
 2. CATHODE  
 3. CATHODE  
 4. NO CONNECTION  
 5. CATHODE  
 6. NO CONNECTION  
 7. CATHODE  
 8. CATHODE  
 9. CATHODE  
 10. NO CONNECTION  
 11. CATHODE  
 12. CATHODE  
 13. NO CONNECTION  
 14. COMMON ANODE

STYLE 5:  
 PIN 1. COMMON CATHODE  
 2. ANODE/CATHODE  
 3. ANODE/CATHODE  
 4. ANODE/CATHODE  
 5. ANODE/CATHODE  
 6. NO CONNECTION  
 7. COMMON ANODE  
 8. COMMON CATHODE  
 9. ANODE/CATHODE  
 10. ANODE/CATHODE  
 11. ANODE/CATHODE  
 12. ANODE/CATHODE  
 13. NO CONNECTION  
 14. COMMON ANODE

STYLE 6:  
 PIN 1. CATHODE  
 2. CATHODE  
 3. CATHODE  
 4. CATHODE  
 5. CATHODE  
 6. CATHODE  
 7. CATHODE  
 8. ANODE  
 9. ANODE  
 10. ANODE  
 11. ANODE  
 12. ANODE  
 13. ANODE  
 14. ANODE

STYLE 7:  
 PIN 1. ANODE/CATHODE  
 2. COMMON ANODE  
 3. COMMON CATHODE  
 4. ANODE/CATHODE  
 5. ANODE/CATHODE  
 6. ANODE/CATHODE  
 7. ANODE/CATHODE  
 8. ANODE/CATHODE  
 9. ANODE/CATHODE  
 10. ANODE/CATHODE  
 11. COMMON CATHODE  
 12. COMMON ANODE  
 13. ANODE/CATHODE  
 14. ANODE/CATHODE

STYLE 8:  
 PIN 1. COMMON CATHODE  
 2. ANODE/CATHODE  
 3. ANODE/CATHODE  
 4. NO CONNECTION  
 5. ANODE/CATHODE  
 6. ANODE/CATHODE  
 7. COMMON ANODE  
 8. COMMON ANODE  
 9. ANODE/CATHODE  
 10. ANODE/CATHODE  
 11. NO CONNECTION  
 12. ANODE/CATHODE  
 13. ANODE/CATHODE  
 14. COMMON CATHODE

<b>DOCUMENT NUMBER:</b>	<b>98ASB42565B</b>	Electronic versions are uncontrolled except when accessed directly from the Document Repository. Printed versions are uncontrolled except when stamped "CONTROLLED COPY" in red.
<b>DESCRIPTION:</b>	<b>SOIC-14 NB</b>	<b>PAGE 2 OF 2</b>

ON Semiconductor and  are trademarks of Semiconductor Components Industries, LLC dba ON Semiconductor or its subsidiaries in the United States and/or other countries. ON Semiconductor reserves the right to make changes without further notice to any products herein. ON Semiconductor makes no warranty, representation or guarantee regarding the suitability of its products for any particular purpose, nor does ON Semiconductor assume any liability arising out of the application or use of any product or circuit, and specifically disclaims any and all liability, including without limitation special, consequential or incidental damages. ON Semiconductor does not convey any license under its patent rights nor the rights of others.

# MECHANICAL CASE OUTLINE

## PACKAGE DIMENSIONS

ON Semiconductor®



SCALE 2:1

### Micro8 CASE 846A-02 ISSUE K

DATE 16 JUL 2020



TOP VIEW

NOTE 3

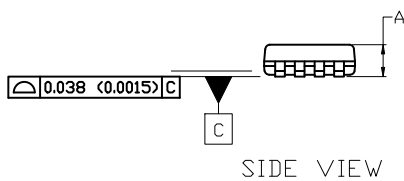

SIDE VIEW



END VIEW

**NOTES:**

1. DIMENSIONING AND TOLERANCING PER ASME Y14.5M, 2009.
2. CONTROLLING DIMENSION: MILLIMETERS
3. DIMENSION *b* DOES NOT INCLUDE DAMBAR PROTRUSION. ALLOWABLE PROTRUSION SHALL BE 0.10 mm IN EXCESS OF MAXIMUM MATERIAL CONDITION.
4. DIMENSIONS *D* AND *E* DO NOT INCLUDE MOLD FLASH, PROTRUSION OR GATE BURRS. MOLD FLASH, PROTRUSIONS, OR GATE BURRS SHALL NOT EXCEED 0.15 mm PER SIDE. DIMENSION *E* DOES NOT INCLUDE INTERLEAD FLASH OR PROTRUSION. INTERLEAD FLASH OR PROTRUSION SHALL NOT EXCEED 0.25 mm PER SIDE. DIMENSIONS *D* AND *E* ARE DETERMINED AT DATUM *F*.
5. DATUMS *A* AND *B* ARE TO BE DETERMINED AT DATUM *F*.
6. *A1* IS DEFINED AS THE VERTICAL DISTANCE FROM THE SEATING PLANE TO THE LOWEST POINT ON THE PACKAGE BODY.

⌀ 0.08 (0.003) M C B S A S

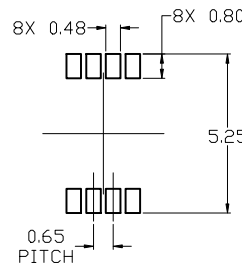

RECOMMENDED MOUNTING FOOTPRINT

DIM	MILLIMETERS		
	MIN.	NOM.	MAX.
A	---	---	1.10
A1	0.05	0.08	0.15
<i>b</i>	0.25	0.33	0.40
<i>c</i>	0.13	0.18	0.23
<i>D</i>	2.90	3.00	3.10
<i>E</i>	2.90	3.00	3.10
<i>e</i>	0.65 BSC		
<i>H<sub>E</sub></i>	4.75	4.90	5.05
<i>L</i>	0.40	0.55	0.70

For additional information on our Pb-Free strategy and soldering details, please download the ON Semiconductor Soldering and Mounting Techniques Reference Manual, SOLDERM/D.

### GENERIC MARKING DIAGRAM\*



- XXXX = Specific Device Code
- A = Assembly Location
- Y = Year
- W = Work Week
- = Pb-Free Package

(Note: Microdot may be in either location)

\*This information is generic. Please refer to device data sheet for actual part marking. Pb-Free indicator, "G" or microdot "▪", may or may not be present. Some products may not follow the Generic Marking.

**STYLE 1:**

1. SOURCE
2. SOURCE
3. SOURCE
4. GATE
5. DRAIN
6. DRAIN
7. DRAIN
8. DRAIN

**STYLE 2:**

1. SOURCE 1
2. GATE 1
3. SOURCE 2
4. GATE 2
5. DRAIN 2
6. DRAIN 2
7. DRAIN 1
8. DRAIN 1

**STYLE 3:**

1. N-SOURCE
2. N-GATE
3. P-SOURCE
4. P-GATE
5. P-DRAIN
6. P-DRAIN
7. N-DRAIN
8. N-DRAIN

<b>DOCUMENT NUMBER:</b>	<b>98ASB14087C</b>	Electronic versions are uncontrolled except when accessed directly from the Document Repository. Printed versions are uncontrolled except when stamped "CONTROLLED COPY" in red.
<b>DESCRIPTION:</b>	<b>MICRO8</b>	<b>PAGE 1 OF 1</b>

ON Semiconductor and ON are trademarks of Semiconductor Components Industries, LLC dba ON Semiconductor or its subsidiaries in the United States and/or other countries. ON Semiconductor reserves the right to make changes without further notice to any products herein. ON Semiconductor makes no warranty, representation or guarantee regarding the suitability of its products for any particular purpose, nor does ON Semiconductor assume any liability arising out of the application or use of any product or circuit, and specifically disclaims any and all liability, including without limitation special, consequential or incidental damages. ON Semiconductor does not convey any license under its patent rights nor the rights of others.

# MECHANICAL CASE OUTLINE

## PACKAGE DIMENSIONS

ON Semiconductor®



**TSSOP-14 WB**  
CASE 948G  
ISSUE C

DATE 17 FEB 2016

SCALE 2:1



**NOTES:**

- DIMENSIONING AND TOLERANCING PER ANSI Y14.5M, 1982.
- CONTROLLING DIMENSION: MILLIMETER.
- DIMENSION A DOES NOT INCLUDE MOLD FLASH, PROTRUSIONS OR GATE BURRS. MOLD FLASH OR GATE BURRS SHALL NOT EXCEED 0.15 (0.006) PER SIDE.
- DIMENSION B DOES NOT INCLUDE INTERLEAD FLASH OR PROTRUSION. INTERLEAD FLASH OR PROTRUSION SHALL NOT EXCEED 0.25 (0.010) PER SIDE.
- DIMENSION K DOES NOT INCLUDE DAMBAR PROTRUSION. ALLOWABLE DAMBAR PROTRUSION SHALL BE 0.08 (0.003) TOTAL IN EXCESS OF THE K DIMENSION AT MAXIMUM MATERIAL CONDITION.
- TERMINAL NUMBERS ARE SHOWN FOR REFERENCE ONLY.
- DIMENSION A AND B ARE TO BE DETERMINED AT DATUM PLANE -W-.

DIM	MILLIMETERS		INCHES	
	MIN	MAX	MIN	MAX
A	4.90	5.10	0.193	0.200
B	4.30	4.50	0.169	0.177
C	---	1.20	---	0.047
D	0.05	0.15	0.002	0.006
F	0.50	0.75	0.020	0.030
G	0.65 BSC		0.026 BSC	
H	0.50	0.60	0.020	0.024
J	0.09	0.20	0.004	0.008
J1	0.09	0.16	0.004	0.006
K	0.19	0.30	0.007	0.012
K1	0.19	0.25	0.007	0.010
L	6.40 BSC		0.252 BSC	
M	0°	8°	0°	8°

**GENERIC MARKING DIAGRAM\***



- A = Assembly Location
- L = Wafer Lot
- Y = Year
- W = Work Week
- = Pb-Free Package

(Note: Microdot may be in either location)

\*This information is generic. Please refer to device data sheet for actual part marking. Pb-Free indicator, "G" or microdot "▪", may or may not be present.

**SOLDERING FOOTPRINT**

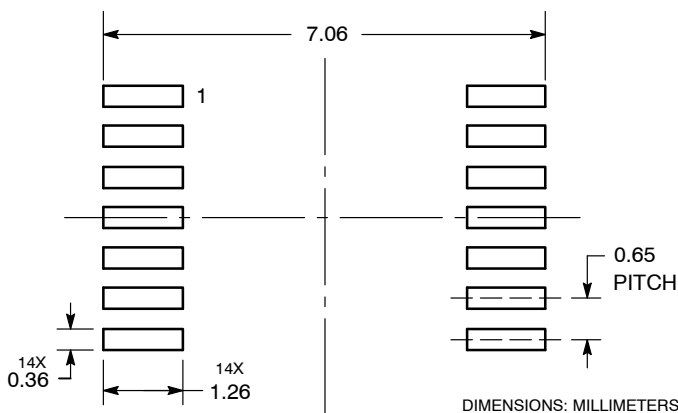

<b>DOCUMENT NUMBER:</b>	<b>98ASH70246A</b>	Electronic versions are uncontrolled except when accessed directly from the Document Repository. Printed versions are uncontrolled except when stamped "CONTROLLED COPY" in red.
<b>DESCRIPTION:</b>	<b>TSSOP-14 WB</b>	<b>PAGE 1 OF 1</b>

ON Semiconductor and ON are trademarks of Semiconductor Components Industries, LLC dba ON Semiconductor or its subsidiaries in the United States and/or other countries. ON Semiconductor reserves the right to make changes without further notice to any products herein. ON Semiconductor makes no warranty, representation or guarantee regarding the suitability of its products for any particular purpose, nor does ON Semiconductor assume any liability arising out of the application or use of any product or circuit, and specifically disclaims any and all liability, including without limitation special, consequential or incidental damages. ON Semiconductor does not convey any license under its patent rights nor the rights of others.

ON Semiconductor and  are trademarks of Semiconductor Components Industries, LLC dba ON Semiconductor or its subsidiaries in the United States and/or other countries. ON Semiconductor owns the rights to a number of patents, trademarks, copyrights, trade secrets, and other intellectual property. A listing of ON Semiconductor's product/patent coverage may be accessed at [www.onsemi.com/site/pdf/Patent-Marking.pdf](http://www.onsemi.com/site/pdf/Patent-Marking.pdf). ON Semiconductor reserves the right to make changes without further notice to any products herein. ON Semiconductor makes no warranty, representation or guarantee regarding the suitability of its products for any particular purpose, nor does ON Semiconductor assume any liability arising out of the application or use of any product or circuit, and specifically disclaims any and all liability, including without limitation special, consequential or incidental damages. Buyer is responsible for its products and applications using ON Semiconductor products, including compliance with all laws, regulations and safety requirements or standards, regardless of any support or applications information provided by ON Semiconductor. "Typical" parameters which may be provided in ON Semiconductor data sheets and/or specifications can and do vary in different applications and actual performance may vary over time. All operating parameters, including "Typicals" must be validated for each customer application by customer's technical experts. ON Semiconductor does not convey any license under its patent rights nor the rights of others. ON Semiconductor products are not designed, intended, or authorized for use as a critical component in life support systems or any FDA Class 3 medical devices or medical devices with a same or similar classification in a foreign jurisdiction or any devices intended for implantation in the human body. Should Buyer purchase or use ON Semiconductor products for any such unintended or unauthorized application, Buyer shall indemnify and hold ON Semiconductor and its officers, employees, subsidiaries, affiliates, and distributors harmless against all claims, costs, damages, and expenses, and reasonable attorney fees arising out of, directly or indirectly, any claim of personal injury or death associated with such unintended or unauthorized use, even if such claim alleges that ON Semiconductor was negligent regarding the design or manufacture of the part. ON Semiconductor is an Equal Opportunity/Affirmative Action Employer. This literature is subject to all applicable copyright laws and is not for resale in any manner.

## PUBLICATION ORDERING INFORMATION

### LITERATURE FULFILLMENT:

Email Requests to: [orderlit@onsemi.com](mailto:orderlit@onsemi.com)

ON Semiconductor Website: [www.onsemi.com](http://www.onsemi.com)

### TECHNICAL SUPPORT

North American Technical Support:  
Voice Mail: 1 800-282-9855 Toll Free USA/Canada  
Phone: 011 421 33 790 2910

Europe, Middle East and Africa Technical Support:

Phone: 00421 33 790 2910

For additional information, please contact your local Sales Representative