

Item no.: 2004-1301
Product description: 3-Conductor through terminal block suitable for Ex e applications

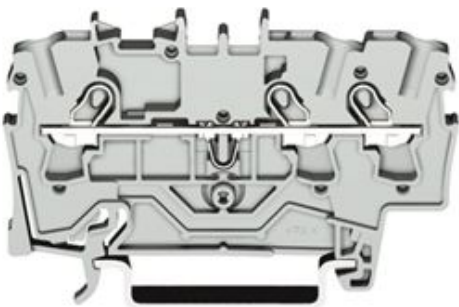

Produkt kann von Bild abweichen / product may differ

Packing unit 50 pieces

RoHS compliant

Current intensity EN	41 A
Product group	22 (TOPJOB S RAIL-MOUNTED TERMINAL BLOCKS)
Cross section [mm ²]	0.5 - 4 mm ²
Cross section [AWG]	20 - 10 AWG
Connection method	CAGE CLAMP®S Connection
Cross section [mm ²]	0.5 - 6 mm ²
Cross section [AWG]	20 - 10 AWG
Wiring method	s + f-st
Connection method	CAGE CLAMP®S Connection
Measured voltage EN	800 V
Measured shock voltage	8 kV
Pollution degree	3
Current intensity EN	32 A
Rated voltage EN (Ex e II)	550 V
Nominal current (Ex e II)	30 A
Weight	8.6 g
Color	grey
Wiring type	Front-entry

No. of connection Points	3
No. of potentials	1
Height	33 mm
Height	1.299 in



Width	6.2 mm
Width	0.244 in
Depth	65.5 mm
Depth	2.581 in
Strip length from	11 mm
Strip length to	13 mm
Strip length	0.47 in
Customs Tariff No.	85369010
Country of Origin	Deutschland
Mounting	TS 35



Item number	Admission office	Approval no.	Voltage [V]	Current [A]	Cross section [mm ²]
2004-1301	ABS	05-HG476175/3-PDA	800	32	0,5-6
2004-1301	CCA	NL6341	800	32/41	0,5-4/6
2004-1301	CSA	154112-1645435	600	30	20-10
2004-1301	DNV	E-10423	800	41	0,5-6
2004-1301	GL	26187-05HH	800	32	0,5-4
2004-1301	KEMA	NL2089139.02	800	32	0,5-6
2004-1301	LR	91/20112(E6)	800	32	0,5-6
2004-1301	PRS	TE/1718/880590/08	800	32	0,5-6
2004-1301	PTB	IECExPTB05.0033U	550	30	0,5-6
2004-1301	PTB	PTB05ATEX1095U	550	30	0,5-6
2004-1301	RosTest	8189158	550	30	0,5-6
2004-1301	UR	E45172	600	30	20-10

Sorting criteria: admission office - approval number

© WAGO Kontakttechnik GmbH & Co. KG

Specifications are subject to changes and errors may be expected