

## FEATURES

**Ultrawideband frequency range: 9 kHz to 40 GHz**

**Attenuation range: 0.5 dB steps to 31.5 dB**

**Low insertion loss with impedance match**

2.0 dB up to 18 GHz

2.8 dB up to 26 GHz

4.5 dB up to 40 GHz

**Attenuation accuracy with impedance match**

$\pm(0.20 + 1.0\%$  of attenuation state) up to 18 GHz

$\pm(0.20 + 1.5\%$  of attenuation state) up to 26 GHz

$\pm(0.40 + 3.0\%$  of attenuation state) up to 40 GHz

**Typical step error with impedance match**

$\pm 0.25$  dB up to 26 GHz

$\pm 0.65$  dB up to 40 GHz

**High input linearity**

P0.1 dB insertion loss state: 30 dBm

P0.1 dB other attenuation states: 27 dBm

IP3: 50 dBm typical

**High RF input power handling: 27 dBm average, 30 dBm peak**

**Tight distribution in relative phase**

**No low frequency spurious signals**

**SPI and parallel mode control, CMOS/LVTTL compatible**

**RF amplitude settling time (0.1 dB of final RF output): 8  $\mu$ s**

**24-terminal, 4 mm  $\times$  4 mm LGA package**

**Pin-compatible with ADRF5730, fast switching version**

## APPLICATIONS

**Industrial scanners**

**Test and instrumentation**

**Cellular infrastructure: 5G millimeter wave**

**Military radios, radars, electronic counter measures (ECMs)**

**Microwave radios and very small aperture terminals (VSATs)**

## GENERAL DESCRIPTION

The ADRF5720 is a silicon, 6-bit digital attenuator with 31.5 dB attenuation control range in 0.5 dB steps.

This device operates from 9 kHz to 40 GHz with better than 4.5 dB of insertion loss and excellent attenuation accuracy. The ATTIN port of the ADRF5720 has a radio frequency (RF) input power handling capability of 27 dBm average and 30 dBm peak for all states.

The ADRF5720 requires a dual supply voltage of +3.3 V and -3.3 V. The device features serial peripheral interface (SPI), parallel mode control, and complementary metal-oxide semiconductor (CMOS)-/low voltage transistor to transistor logic (LVTTL)-compatible controls.

Rev. B

[Document Feedback](#)

Information furnished by Analog Devices is believed to be accurate and reliable. However, no responsibility is assumed by Analog Devices for its use, nor for any infringements of patents or other rights of third parties that may result from its use. Specifications subject to change without notice. No license is granted by implication or otherwise under any patent or patent rights of Analog Devices. Trademarks and registered trademarks are the property of their respective owners.

## FUNCTIONAL BLOCK DIAGRAM

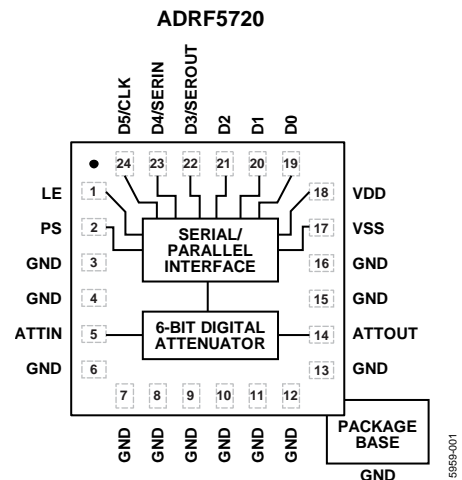

Figure 1.

The ADRF5720 is pin-compatible with the [ADRF5730](#), the fast switching version, which operates from 100 MHz to 40 GHz.

The ADRF5720 RF ports are designed to match a characteristic impedance of 50  $\Omega$ . For wideband applications, impedance matching on the RF transmission lines can further optimize high frequency insertion loss, return loss, and attenuation accuracy characteristics. Refer to the Electrical Specifications section, the Typical Performance Characteristics section, and the Applications Information section for more details.

The ADRF5720 comes in a 24-terminal, 4 mm  $\times$  4 mm, RoHS compliant, land grid array (LGA) package and operates from -40°C to +105°C.

**TABLE OF CONTENTS**

Features ..... 1

Applications..... 1

Functional Block Diagram ..... 1

General Description ..... 1

Revision History ..... 2

Specifications..... 3

    Electrical Specifications..... 3

    Timing Specifications ..... 5

Absolute Maximum Ratings..... 6

    Power Derating Curves..... 6

    ESD Caution..... 6

Pin Configuration and Function Descriptions..... 7

    Interface Schematics..... 7

Typical Performance Characteristics ..... 8

    Insertion Loss, Return Loss, State Error, Step Error, and  
    Relative Phase .....8

    Input Power Compression and Third-Order Intercept..... 12

Theory of Operation ..... 13

    Power Sequence ..... 13

    RF Input and Output ..... 13

    Serial or Parallel Mode Selection ..... 14

    Serial Mode Interface..... 14

    Parallel Mode Interface..... 15

Applications Information ..... 16

    Evaluation Board ..... 16

    Probe Matrix Board ..... 18

Outline Dimensions ..... 19

    Ordering Guide ..... 19

**REVISION HISTORY**

**11/2020—Rev. A to Rev. B**

Changes to  $t_{CH}$  Parameter and  $t_{CO}$  Parameter, Table 2 ..... 5

Changes to Figure 26 and Figure 27..... 11

Changes to Serial Mode Interface Section, Using SEROUT Section,  
and Figure 34 ..... 14

Deleted Figure 33; Renumbered Sequentially ..... 14

**3/2020—Rev. 0 to Rev. A**

Changes to RF Power Parameter, Table 1.....5

Changes to Table 3.....6

Changes to Power Supply Section ..... 13

Added Power-Up State Section..... 13

Moved Serial or Parallel Mode Selection Section and Table 7;  
Renumbered Sequentially .....14

**7/2018—Revision 0: Initial Version**

## SPECIFICATIONS

### ELECTRICAL SPECIFICATIONS

VDD = 3.3 V, VSS = -3.3 V, digital voltages = 0 V or VDD, case temperature (T<sub>CASE</sub>) = 25°C, and 50 Ω system, unless otherwise noted.

Table 1.

Parameter	Test Conditions/Comments	Min	Typ	Max	Unit	
FREQUENCY RANGE		0.009		40,000	MHz	
INSERTION LOSS (IL)	With Impedance Match See Figure 43	9 kHz to 10 GHz	1.5		dB	
		10 GHz to 18 GHz	2.0		dB	
		18 GHz to 26 GHz	2.8		dB	
		26 GHz to 35 GHz	3.7		dB	
		35 GHz to 40 GHz	4.5		dB	
		Without Impedance Match See Figure 42	9 kHz to 10 GHz	1.6		dB
	10 GHz to 18 GHz		2.1		dB	
	18 GHz to 26 GHz		2.7		dB	
	26 GHz to 35 GHz		3.6		dB	
	35 GHz to 40 GHz		4.6		dB	
	RETURN LOSS		With Impedance Match ATTIN and ATTOUT, all attenuation states See Figure 43	9 kHz to 10 GHz	18	
		10 GHz to 18 GHz		17		dB
18 GHz to 26 GHz		17			dB	
26 GHz to 35 GHz		15			dB	
35 GHz to 40 GHz		15			dB	
Without Impedance Match See Figure 42		9 kHz to 10 GHz		18		dB
		10 GHz to 18 GHz	15		dB	
		18 GHz to 26 GHz	15		dB	
		26 GHz to 35 GHz	14		dB	
		35 GHz to 40 GHz	11		dB	
		ATTENUATION	Range	Between minimum and maximum attenuation states	31.5	
Step Size				Between any successive attenuation states	0.5	
Accuracy Referenced to insertion loss	With Impedance Match See Figure 43		9 kHz to 10 GHz	±(0.15 + 1.0% of state)		dB
			10 GHz to 18 GHz	±(0.20 + 1.0% of state)		dB
			18 GHz to 26 GHz	±(0.20 + 1.5% of state)		dB
			26 GHz to 35 GHz	±(0.25 + 2.5% of state)		dB
			35 GHz to 40 GHz	±(0.40 + 3.0% of state)		dB
			Without Impedance Match See Figure 42	9 kHz to 10 GHz	±(0.15 + 1.0% of state)	
	10 GHz to 18 GHz			±(0.25 + 1.0% of state)		dB
	18 GHz to 26 GHz			±(0.20 + 1.5% of state)		dB
	26 GHz to 35 GHz			±(0.25 + 2.0% of state)		dB
	35 GHz to 40 GHz		±(0.40 + 5.0% of state)		dB	

Parameter	Test Conditions/Comments	Min	Typ	Max	Unit	
Step Error With Impedance Match  Without Impedance Match	Between any successive state					
	See Figure 43					
	9 kHz to 10 GHz		±0.15		dB	
	10 GHz to 18 GHz		±0.23		dB	
	18 GHz to 26 GHz		±0.25		dB	
	26 GHz to 35 GHz		±0.50		dB	
	35 GHz to 40 GHz		±0.65		dB	
	See Figure 42					
	9 kHz to 10 GHz		±0.15		dB	
	10 GHz to 18 GHz		±0.23		dB	
18 GHz to 26 GHz		±0.25		dB		
26 GHz to 35 GHz		±0.40		dB		
35 GHz to 40 GHz		±0.70		dB		
RELATIVE PHASE With Impedance Match  Without Impedance Match	Referenced to insertion loss					
	See Figure 43					
	10 GHz		15		Degrees	
	18 GHz		30		Degrees	
	26 GHz		50		Degrees	
	35 GHz		75		Degrees	
	40 GHz		100		Degrees	
	See Figure 42					
	10 GHz		15		Degrees	
	18 GHz		30		Degrees	
26 GHz		50		Degrees		
35 GHz		80		Degrees		
40 GHz		105		Degrees		
SWITCHING CHARACTERISTICS	All attenuation states at input power = 10 dBm					
	Rise and Fall Time (t <sub>RISE</sub> and t <sub>FALL</sub> )		1.3		µs	
	On and Off Time (t <sub>ON</sub> and t <sub>OFF</sub> )	50% triggered control (CTL) to 90% of RF output		3.9		µs
	RF Amplitude Settling Time					
	0.1 dB	50% triggered CTL to 0.1 dB of final RF output		8		µs
	0.05 dB	50% triggered CTL to 0.05 dB of final RF output		10		µs
	Overshoot			2		dB
	Undershoot			-1.5		dB
RF Phase Settling Time	f = 5 GHz					
	5°	50% triggered CTL to 5° of final RF output		3		µs
	1°	50% triggered CTL to 1° of final RF output		4		µs
INPUT LINEARITY <sup>1</sup>	1 MHz to 30 GHz					
	0.1 dB Power Compression (P0.1dB)					
	Insertion Loss State		30		dBm	
	Other Attenuation States		27		dBm	
Third-Order Intercept (IP3)	Two-tone input power = 14 dBm per tone, Δf = 1 MHz, all attenuation states		50		dBm	
DIGITAL CONTROL INPUTS	LE, PS, D0, D1, D2, D3/SEROUT <sup>2</sup> , D4/SERIN, D5/CLK pins					
	Voltage					
	Low (V <sub>INL</sub> )	0		0.8	V	
	High (V <sub>INH</sub> )	1.2		3.3	V	
	Current					
	Low (I <sub>INL</sub> )		<1		µA	
	High (I <sub>INH</sub> )	D0, D1, D2		33		µA
	LE, PS, D3/SEROUT <sup>2</sup> , D4/SERIN, D5/CLK pins		<1		µA	

Parameter	Test Conditions/Comments	Min	Typ	Max	Unit
DIGITAL CONTROL OUTPUT	D3/SEROUT pin <sup>2</sup>				
Voltage					
Low (V <sub>OUTL</sub> )			0 ± 0.3		V
High (V <sub>OUTH</sub> )			VDD ± 0.3		V
Current (I <sub>OUTL</sub> , I <sub>OUTH</sub> )				0.5	mA
SUPPLY CURRENT	VDD and VSS pins				
Positive Supply Current			117		μA
Negative Supply Current			-117		μA
RECOMMENDED OPERATING CONDITIONS					
Supply Voltage					
Positive (VDD)		3.15		3.45	V
Negative (VSS)		-3.45		-3.15	V
Digital Control Voltage		0		VDD	V
RF Power <sup>3</sup>	f = 1 MHz to 30 GHz, T <sub>CASE</sub> = 85°C <sup>4</sup> , all attenuation states				
Input at ATTIN	Steady state average			27	dBm
	Steady state peak			30	dBm
	Hot switching average			24	dBm
	Hot switching peak			27	dBm
Input at ATTOUT	Steady state average			18	dBm
	Steady state peak			21	dBm
	Hot switching average			15	dBm
	Hot switching peak			18	dBm
Case Temperature (T <sub>CASE</sub> )		-40		+105	°C

<sup>1</sup> Input linearity performance degrades over frequency, see Figure 30 and Figure 31.

<sup>2</sup> The D3/SEROUT pin is an input in parallel control mode and an output in serial control mode. See Table 5 for the pin function descriptions.

<sup>3</sup> For power derating over frequency, see Figure 2 to Figure 3. Applicable for all ATTIN and ATTOUT power specifications.

<sup>4</sup> For 105°C operation, the power handling degrades from the T<sub>CASE</sub> = 85°C specifications by 3 dB.

## TIMING SPECIFICATIONS

See Figure 33, Figure 34, and Figure 35 for the timing diagrams.

Table 2.

Parameter	Description	Min	Typ	Max	Unit
t <sub>SCK</sub>	Minimum serial period, see Figure 33	70			ns
t <sub>CS</sub>	Control setup time, see Figure 33	15			ns
t <sub>CH</sub>	Control hold time, see Figure 33		3	5	ns
t <sub>LN</sub>	LE setup time, see Figure 33	15			ns
t <sub>LEW</sub>	Minimum LE pulse width, see Figure 33 and Figure 35		10		ns
t <sub>LES</sub>	Minimum LE pulse spacing, see Figure 33		630		ns
t <sub>CKN</sub>	Serial clock hold time from LE, see Figure 33		0		ns
t <sub>PH</sub>	Hold time, see Figure 35		10		ns
t <sub>PS</sub>	Setup time, see Figure 35		2		ns
t <sub>CO</sub>	Clock to output (SEROUT) time, see Figure 34	15	20	25	ns

# ABSOLUTE MAXIMUM RATINGS

Table 3.

Parameter	Rating
Positive Supply Voltage	-0.3 V to +3.6 V
Negative Supply Voltage	-3.6 V to +0.3 V
Digital Control Inputs	
Voltage	-0.3 V to VDD + 0.3 V
Current	3 mA
RF Power <sup>1</sup> (f = 1 MHz to 30 GHz, T <sub>CASE</sub> = 85°C <sup>2</sup> )	
Input at ATTIN	
Steady State Average	28 dBm
Steady State Peak	31 dBm
Hot Switching Average	25 dBm
Hot Switching Peak	28 dBm
Input at ATTOUT	
Steady State Average	19 dBm
Steady State Peak	22 dBm
Hot Switching Average	16 dBm
Hot Switching Peak	19 dBm
RF Power Under Unbiased Condition (V <sub>DD</sub> , V <sub>SS</sub> = 0 V)	
Input at ATTIN	21 dBm
Input at ATTOUT	15 dBm
Temperature	
Junction (T <sub>J</sub> )	135°C
Storage	-65°C to +150°C
Reflow	260°C
Continuous Power Dissipation (P <sub>DISS</sub> )	0.5 W
Electrostatic Discharge (ESD) Sensitivity	
Human Body Model (HBM)	
ATTIN and ATTOUT Pins	1500 V
Digital Pins	2000 V
Charged Device Model (CDM)	1250 V

<sup>1</sup> For power derating over frequency, see Figure 2 and Figure 3. Applicable for all ATTIN and ATTOUT power specifications.

<sup>2</sup> For 105°C operation, the power handling degrades from the T<sub>CASE</sub> = 85°C specifications by 3 dB.

Stresses at or above those listed under Absolute Maximum Ratings may cause permanent damage to the product. This is a stress rating only; functional operation of the product at these or any other conditions above those indicated in the operational section of this specification is not implied. Operation beyond the maximum operating conditions for extended periods may affect product reliability.

## THERMAL RESISTANCE

Thermal performance is directly linked to printed circuit board (PCB) design and operating environment. Careful attention to PCB thermal design is required.

θ<sub>JC</sub> is the junction to case bottom (channel to package bottom) thermal resistance.

Table 4. Thermal Resistance

Package Type	θ <sub>JC</sub>	Unit
CC-24-5	100	°C/W

## POWER DERATING CURVES

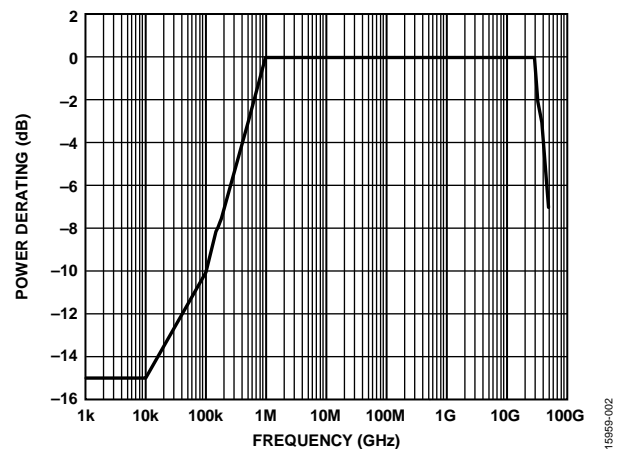

Figure 2. Power Derating vs. Frequency, Low Frequency Detail, T<sub>CASE</sub> = 85°C

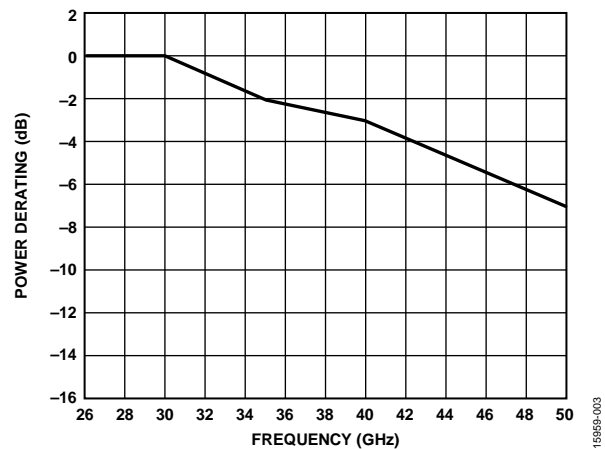

Figure 3. Power Derating vs. Frequency, High Frequency Detail, T<sub>CASE</sub> = 85°C

## ESD CAUTION



**ESD (electrostatic discharge) sensitive device.** Charged devices and circuit boards can discharge without detection. Although this product features patented or proprietary protection circuitry, damage may occur on devices subjected to high energy ESD. Therefore, proper ESD precautions should be taken to avoid performance degradation or loss of functionality.

# PIN CONFIGURATION AND FUNCTION DESCRIPTIONS

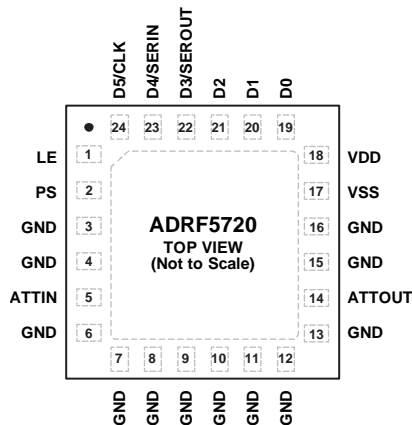

**NOTES**  
1. THE EXPOSED PAD MUST BE CONNECTED TO THE RF AND DC GROUND OF THE PCB.

15959-004

Figure 4. Pin Configuration

Table 5. Pin Function Descriptions

Pin No.	Mnemonic	Description
1	LE	Latch Enable Input. See the Theory of Operation section for more information.
2	PS	Parallel or Serial Control Interface Selection Input. See the Theory of Operation section for more information.
3, 4, 6 to 13, 15, 16	GND	Ground. These pins must be connected to the RF and dc ground of the PCB.
5	ATTIN	Attenuator Input. This pin is dc-coupled to 0 V and ac matched to 50 Ω. No dc blocking capacitor is necessary when the RF line potential is equal to 0 V dc.
14	ATTOUT	Attenuator Output. This pin is dc-coupled to 0 V and ac matched to 50 Ω. No dc blocking capacitor is necessary when the RF line potential is equal to 0 V dc.
17	VSS	Negative Supply Input.
18	VDD	Positive Supply Input.
19	D0	Parallel Control Input for 0.5 dB Attenuator Bit. See the Theory of Operation section for more information.
20	D1	Parallel Control Input for 1 dB Attenuator Bit. See the Theory of Operation section for more information.
21	D2	Parallel Control Input for 2 dB Attenuator Bit. See the Theory of Operation section for more information.
22	D3/SEROUT	Parallel Control Input for 4 dB Attenuator Bit (D3). Serial Data Output (SEROUT). See the Theory of Operation section for more information.
23	D4/SERIN	Parallel Control Input for 8 dB Attenuator Bit (D4). Serial Data Input (SERIN). See the Theory of Operation section for more information.
24	D5/CLK	Parallel Control Input for 16 dB Attenuator Bit (D5). Serial Clock Input (CLK). See the Theory of Operation section for more information.
	EPAD	Exposed Pad. The exposed pad must be connected to the RF and dc ground of the PCB.

## INTERFACE SCHEMATICS

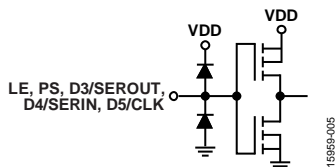

Figure 5. Digital Input Interface (LE, PS, D3/SEROUT, D4/SERIN, D5/CLK)

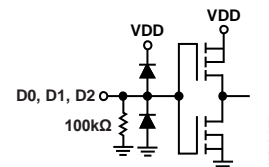

Figure 7. Digital Input Interface (D0, D1, D2)

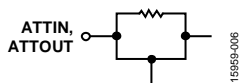

Figure 6. ATTIN and ATTOUT Interface

# TYPICAL PERFORMANCE CHARACTERISTICS

## INSERTION LOSS, RETURN LOSS, STATE ERROR, STEP ERROR, AND RELATIVE PHASE

VDD = 3.3 V, VSS = -3.3 V, digital voltages = 0 V or VDD, T<sub>CASE</sub> = 25°C, and a 50 Ω system, unless otherwise noted. Measured on probe matrix board using ground signal ground (GSG) probes close to the RF pins (ATTIN and ATTOUT). See the Applications Information section for details on evaluation and probe matrix boards.

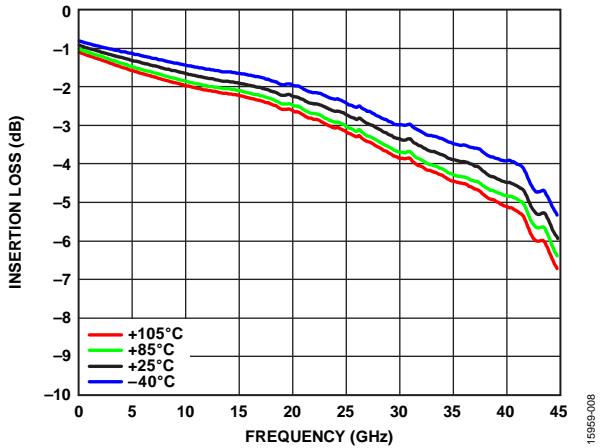

Figure 8. Insertion Loss vs. Frequency over Temperature with Impedance Match

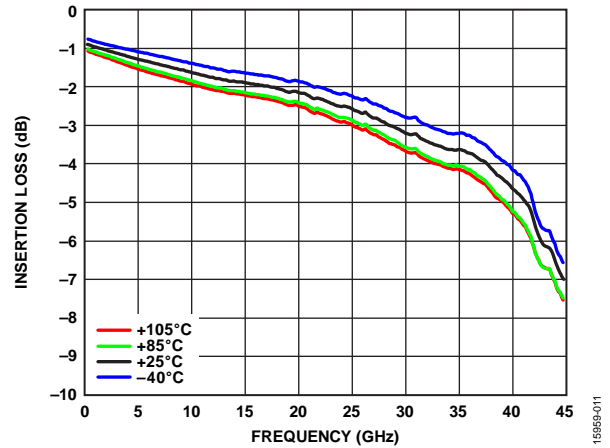

Figure 11. Insertion Loss vs. Frequency over Temperature Without Impedance Match

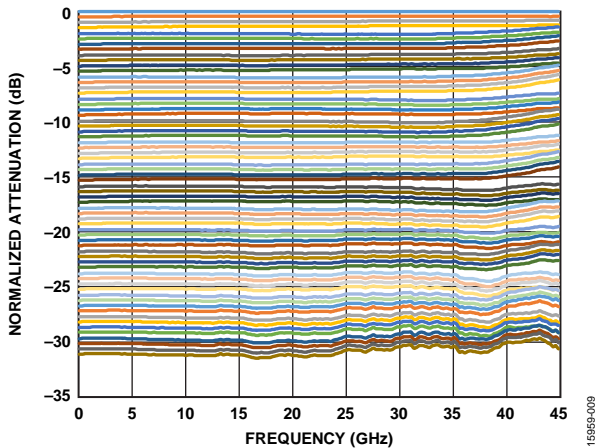

Figure 9. Normalized Attenuation vs. Frequency for All States at Room Temperature with Impedance Match

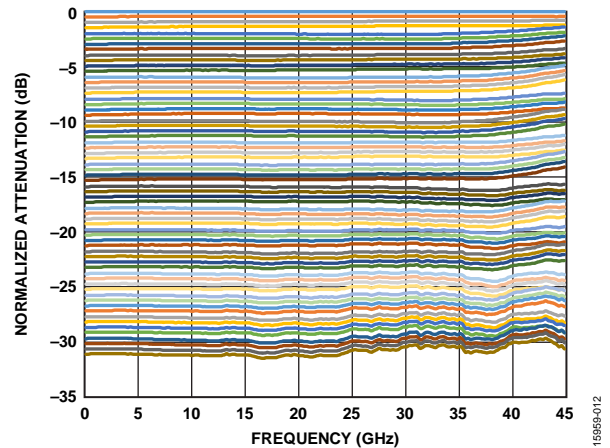

Figure 12. Normalized Attenuation vs. Frequency for All States at Room Temperature Without Impedance Match

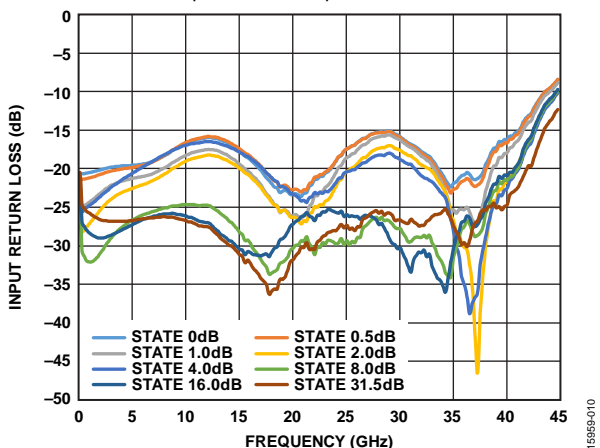

Figure 10. Input Return Loss vs. Frequency (Major States Only) with Impedance Match

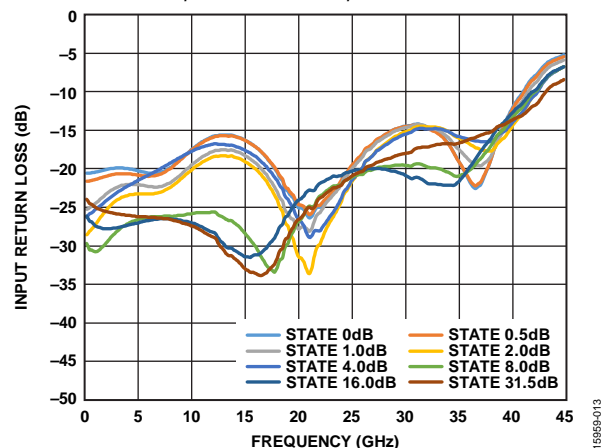

Figure 13. Input Return Loss vs. Frequency (Major States Only) Without Impedance Match



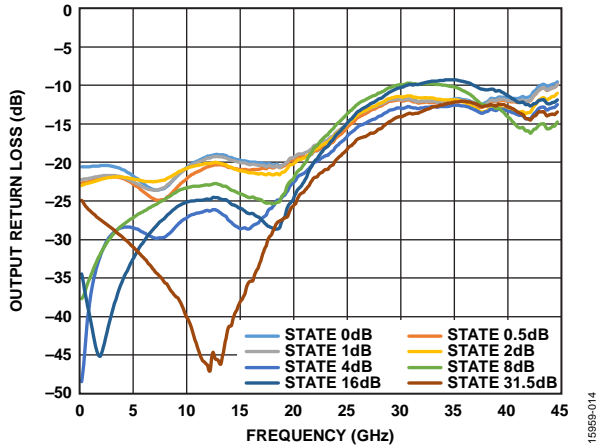

Figure 14. Output Return Loss vs. Frequency (Major States Only) with Impedance Match

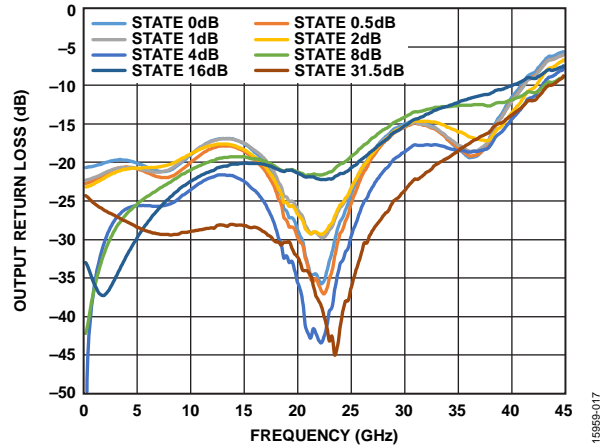

Figure 17. Output Return Loss vs. Frequency (Major States Only) Without Impedance Match

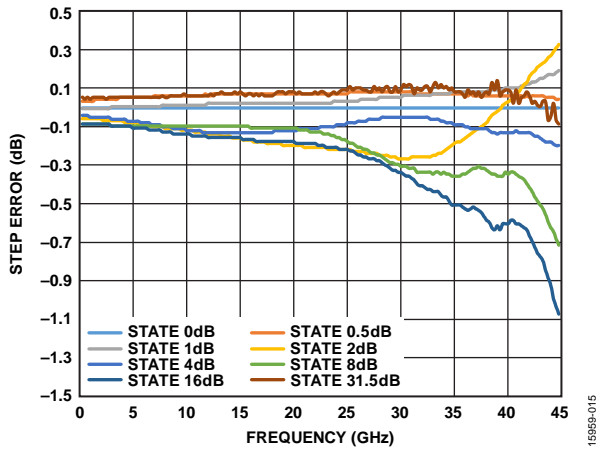

Figure 15. Step Error vs. Frequency (Major States Only) with Impedance Match

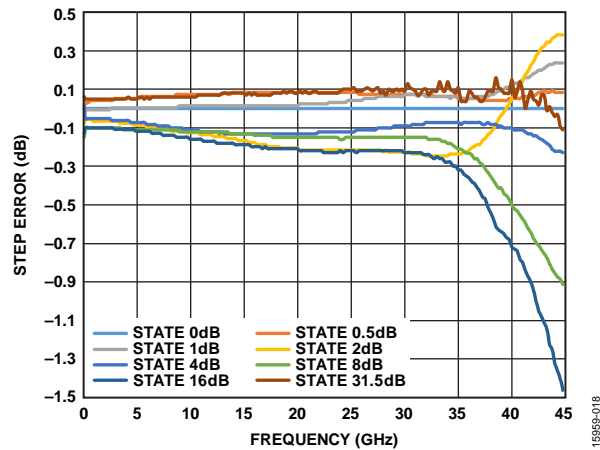

Figure 18. Step Error vs. Frequency (Major States Only) Without Impedance Match

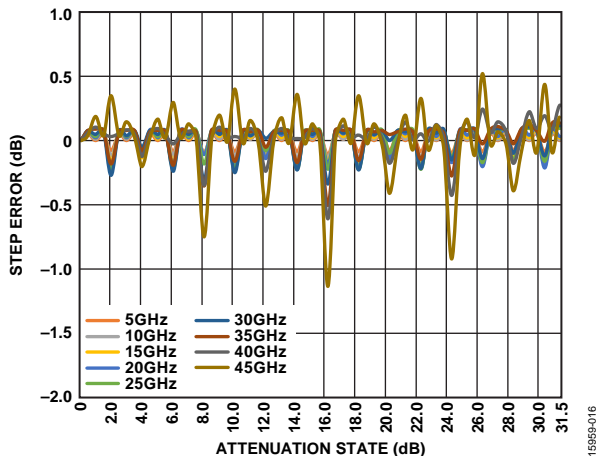

Figure 16. Step Error vs. Attenuation State over Frequency with Impedance Match

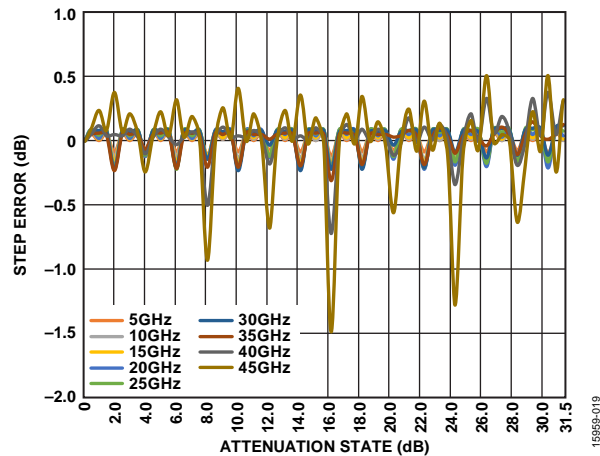

Figure 19. Step Error vs. Attenuation State over Frequency Without Impedance Match

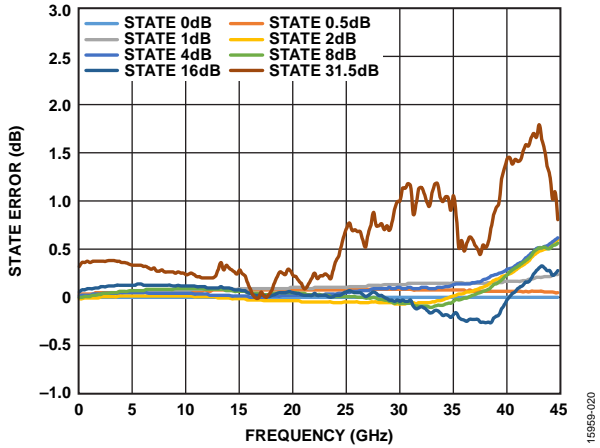

Figure 20. State Error vs. Frequency (Major States Only) with Impedance Match

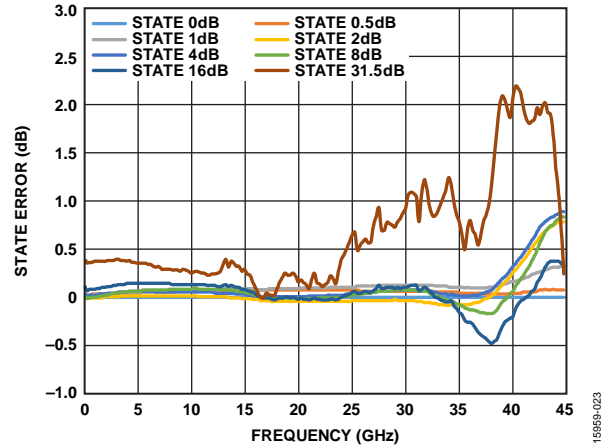

Figure 23. State Error vs. Frequency (Major States Only) Without Impedance Match

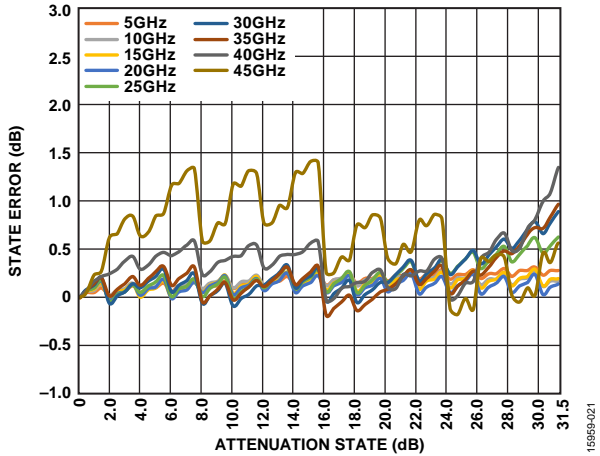

Figure 21. State Error vs. Attenuation State over Frequency with Impedance Match

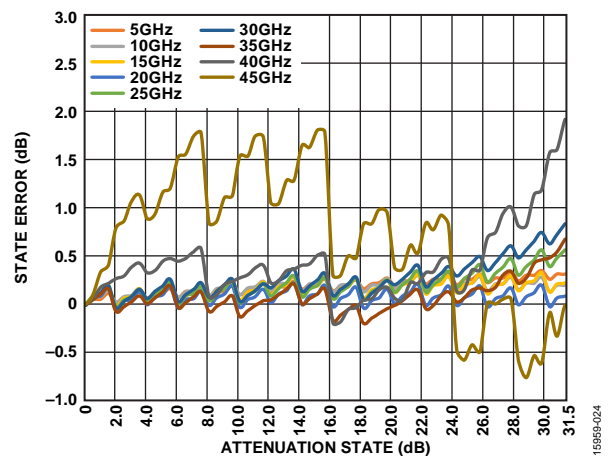

Figure 24. State Error vs. Attenuation State over Frequency Without Impedance Match

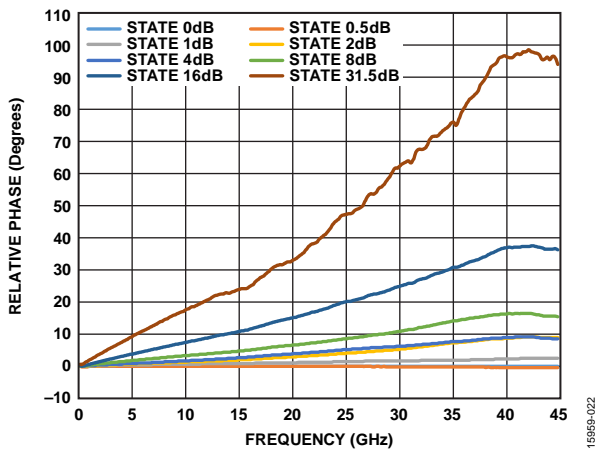

Figure 22. Relative Phase vs. Frequency (Major States Only) with Impedance Match

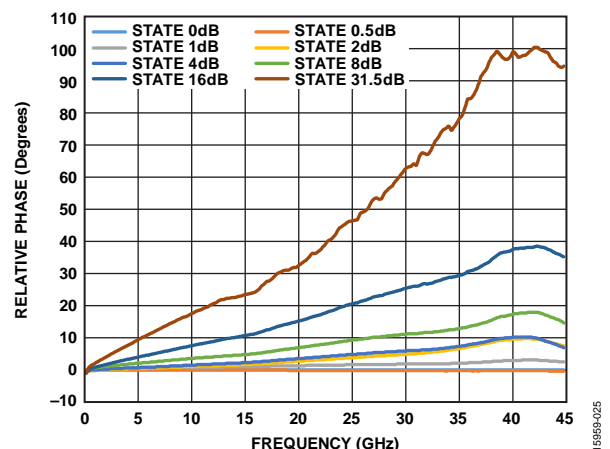

Figure 25. Relative Phase vs. Frequency (Major States Only) Without Impedance Match

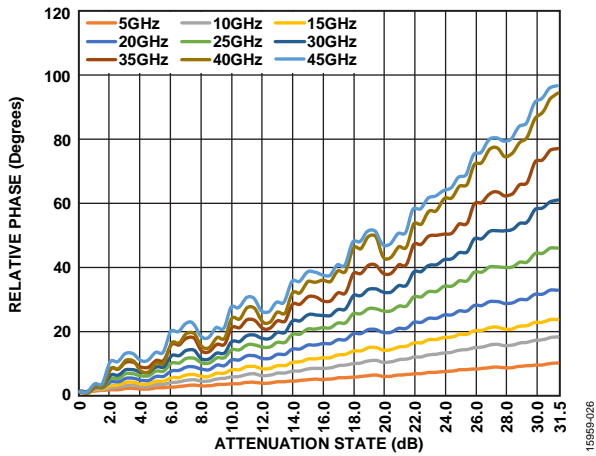

Figure 26. Relative Phase vs. Attenuation State over Frequency with Impedance Match

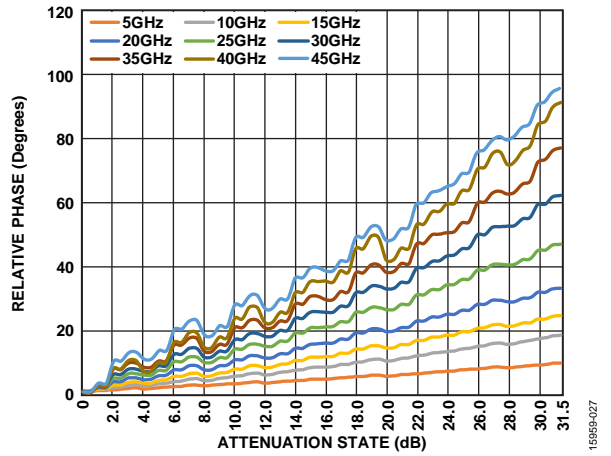

Figure 27. Relative Phase vs. Attenuation State over Frequency Without Impedance Match

INPUT POWER COMPRESSION AND THIRD-ORDER INTERCEPT

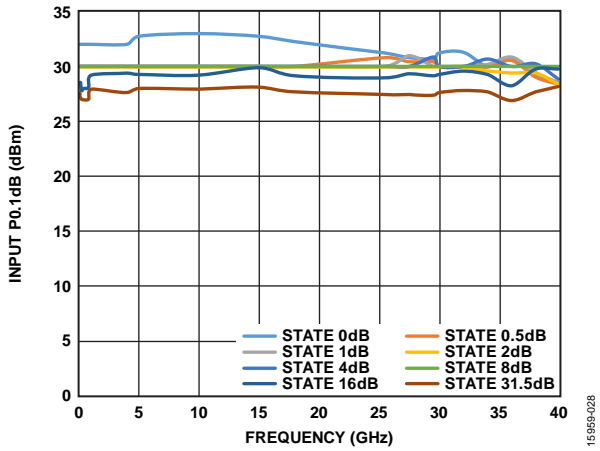

Figure 28. Input P0.1dB vs. Frequency (Major States Only)

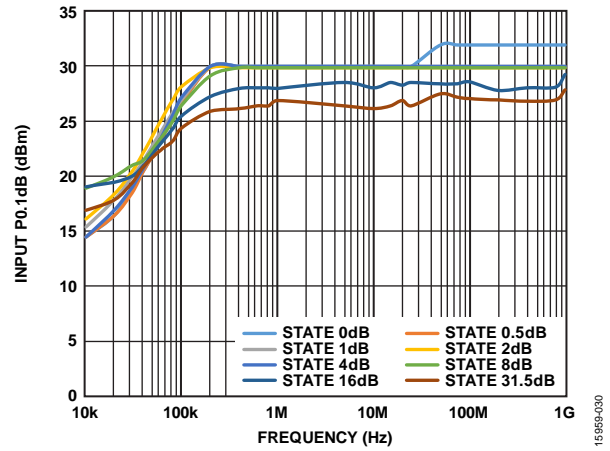

Figure 30. Input P0.1dB vs. Frequency (Major States Only), Low Frequency Detail

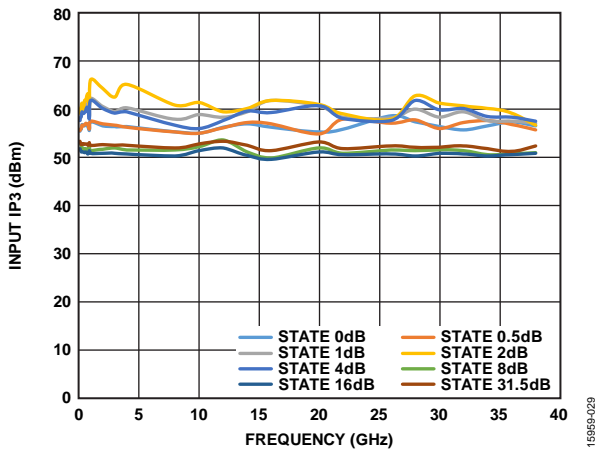

Figure 29. Input IP3 vs. Frequency (Major States Only)

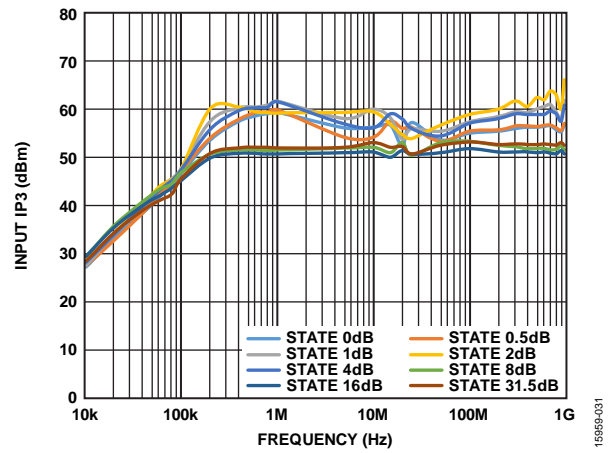

Figure 31. Input IP3 vs. Frequency (Major States Only), Low Frequency Detail

## THEORY OF OPERATION

The ADRF5720 incorporates a 6-bit fixed attenuator array that offers an attenuation range of 31.5 dB in 0.5 dB steps. An integrated driver provides both serial and parallel mode control of the attenuator array (see Figure 32).

Note that when referring to a single function of a multifunction pin in this section, only the portion of the pin name that is relevant is mentioned. For full pin names of the multifunction pins, refer to the Pin Configuration and Function Descriptions section.

### POWER SEQUENCE

Bypassing capacitors are recommended on the positive supply voltage line (VDD) and negative supply line (VSS) to filter high frequency noise.

The power-up sequence is as follows:

1. Connect GND.
2. Power up the VDD and VSS voltages. Power up VSS after VDD to avoid current transients on VDD during ramp-up.
3. Power up the digital control inputs. The order of the digital control inputs is not important. However, powering the digital control inputs before the VDD voltage supply may inadvertently forward bias and damage the internal ESD structures. To avoid this damage, use a series 1 kΩ resistor to limit the current flowing in to the control pin. Use pull-up or pull-down resistors if the controller output is in a high impedance state after the VDD voltage is powered up and the control pins are not driven to a valid logic state.

4. Apply an RF input signal to ATTIN or ATTOUT.

The power-down sequence is the reverse order of the power-up sequence.

### Power-Up State

The ADRF5720 has internal power-on reset circuitry. This circuitry sets the attenuator to the maximum attenuation state (31.5 dB) when the VDD and VSS voltages are applied and LE is set to low.

### RF INPUT AND OUTPUT

Both RF ports (ATTIN and ATTOUT) are dc-coupled to 0 V. No dc blocking is required at the RF ports when the RF line potential is equal to 0 V.

The RF ports are internally matched to 50 Ω. Therefore, external matching components are not required. For wideband applications, use impedance matching to improve insertion loss, return loss, and attenuation accuracy performance at high frequencies. See the Impedance Matching section.

The ADRF5720 supports bidirectional operation at a lower power level. The power handling of the ATTIN and ATTOUT ports are different. Therefore, the bidirectional power handling is defined by the ATTOUT port. Refer to the RF input power specifications in Table 1.

Table 6. Truth Table

Digital Control Input <sup>1</sup>						Attenuation State (dB)
D5	D4	D3	D2	D1	D0	
Low	Low	Low	Low	Low	Low	0 (reference)
Low	Low	Low	Low	Low	High	0.5
Low	Low	Low	Low	High	Low	1.0
Low	Low	Low	High	Low	Low	2.0
Low	Low	High	Low	Low	Low	4.0
Low	High	Low	Low	Low	Low	8.0
High	Low	Low	Low	Low	Low	16.0
High	High	High	High	High	High	31.5

<sup>1</sup> Any combination of the control voltage input states shown in Table 6 provides an attenuation equal to the sum of the bits selected.

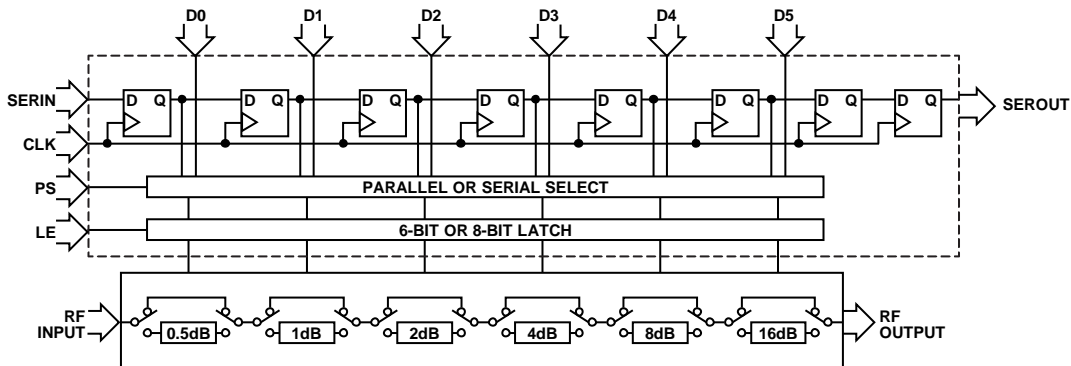

Figure 32. Simplified Circuit Diagram

**SERIAL OR PARALLEL MODE SELECTION**

The ADRF5720 can be controlled in either serial or parallel mode by setting the PS pin to high or low, respectively (see Table 7).

**Table 7. Mode Selection**

PS	Control Mode
Low	Parallel
High	Serial

**SERIAL MODE INTERFACE**

The ADRF5720 supports a 4-wire SPI: serial data input (SERIN), clock (CLK), serial data output (SEROUT), and latch enable (LE). The serial control interface is activated when PS is set to high.

The ADRF5720 attenuation states can be controlled using 6-bit or 8-bit SERIN data. If an 8-bit word is used to control the state of the attenuator, the first two bits, D7 and D6, are don't care bits. It does not matter if these two bits are held low or high, or if they are omitted altogether. Only Bits[D0:D5] set the state of the attenuator.

In serial mode, the SERIN data is clocked most significant bit (MSB) first on the rising CLK edges into the shift register. Then, LE must be toggled high to latch the new attenuation state into the device. LE must be set to low to clock new SERIN data into the shift register as CLK is masked to prevent the attenuator value from changing if LE is kept high. See Figure 33 in conjunction with Table 2 and Table 6.

**Using SEROUT**

The ADRF5720 also features a serial data output, SEROUT. SEROUT outputs the serial input data at the 8<sup>th</sup> clock cycle, and can control a cascaded attenuator using a single SPI bus. Figure 34 shows the serial out timing diagram.

When using the attenuator in a daisy-chain operation, 8-bit SERIN data must be used due to the 8 clock cycle delay between SERIN and SEROUT. The SEROUT pin does not support high impedance mode. A tristate buffer can be used to interface a shared bus.

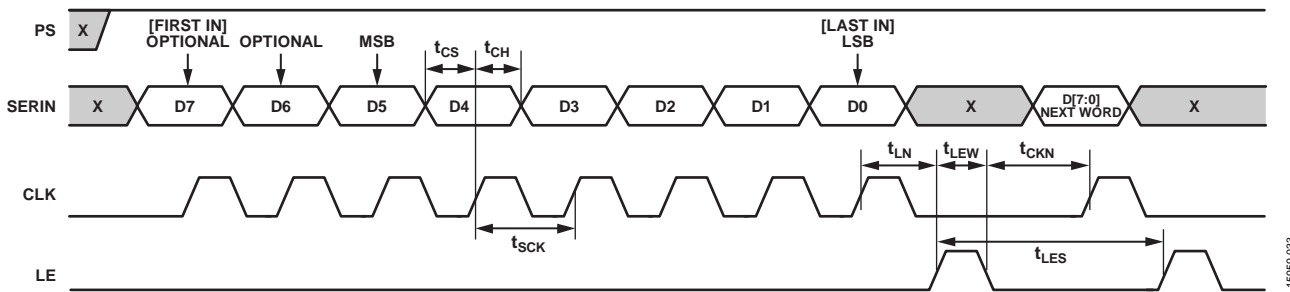

Figure 33. Serial Control Timing Diagram

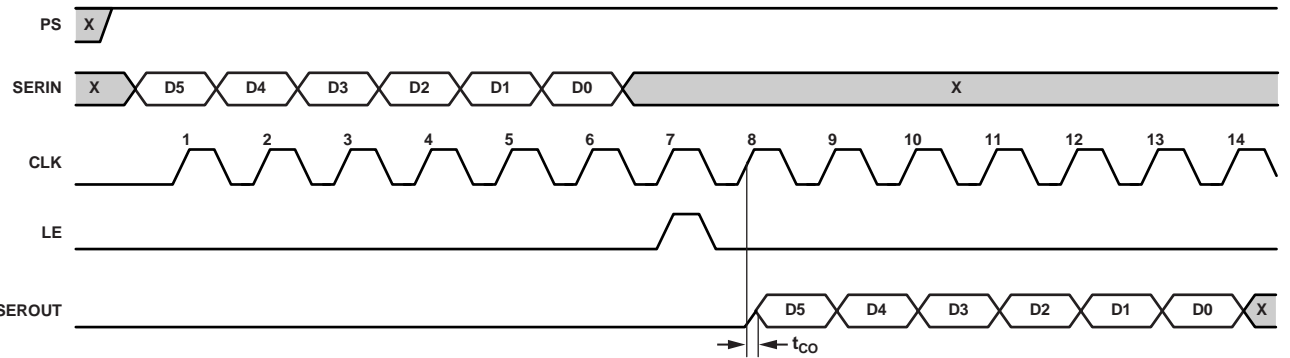

Figure 34. Serial Output Timing Diagram

## PARALLEL MODE INTERFACE

The ADRF5720 has six digital control inputs, D0 (LSB) to D5 (MSB), to select the desired attenuation state in parallel mode, as shown in Table 6. The parallel control interface is activated when PS is set to low.

There are two modes of parallel operation: direct parallel and latched parallel.

### Direct Parallel Mode

To enable direct parallel mode, the LE pin must be kept high. The attenuation state is changed by the control voltage inputs (D0 to D5) directly. This mode is ideal for manual control of the attenuator.

### Latched Parallel Mode

To enable latched parallel mode, the LE pin must be kept low when changing the control voltage inputs (D0 to D5) to set the attenuation state. When the desired state is set, LE must be toggled high to transfer the 6-bit data to the bypass switches of the attenuator array, and then toggled low to latch the change into the device until the next desired attenuation change (see Figure 35 in conjunction with Table 2).

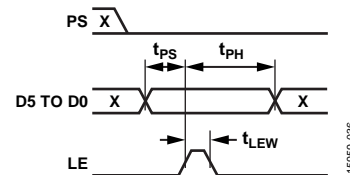

Figure 35. Latched Parallel Mode Timing Diagram

## APPLICATIONS INFORMATION

### EVALUATION BOARD

The [ADRF5720-EVALZ](#) is a 4-layer evaluation board. The top and bottom copper layer are 0.5 oz (0.7 mil) plated to 1.5 oz (2.2 mil) and are separated by dielectric materials. The stackup for this evaluation board is shown in Figure 36.

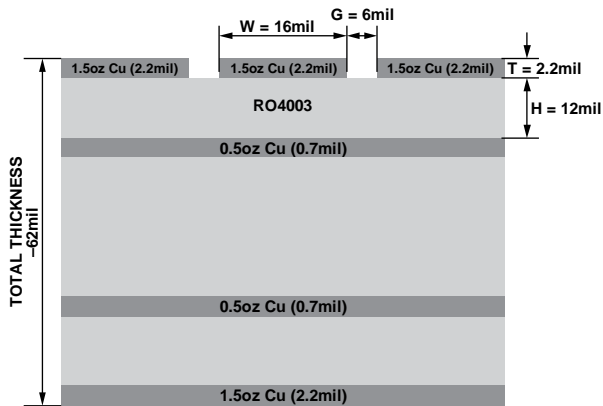

Figure 36. Evaluation Board Stackup

All RF and dc traces are routed on the top copper layer, whereas the inner and bottom layers are grounded planes that provide a solid ground for the RF transmission lines. The top dielectric material is 12 mil Rogers RO4003, offering optimal high frequency performance. The middle and bottom dielectric materials provide mechanical strength. The overall board thickness is 62 mil, which allows 2.4 mm RF launchers to be connected at the board edges.

The RF transmission lines are designed using a coplanar waveguide (CPWG) model, with a trace width of 16 mil and ground clearance of 6 mil to have a characteristic impedance of 50 Ω. For optimal RF and thermal grounding, as many through vias as possible are arranged around transmission lines and under the exposed pad of the package.

The [ADRF5720-EVALZ](#) does not have high frequency impedance matching implemented on the RF transmission lines. For more details on the impedance matched circuit, refer to the Impedance Matching portion of the Probe Matrix Board section.

Thru calibration can be used to calibrate out the board loss effects from the [ADRF5720-EVALZ](#) evaluation board measurements to determine the device performance at the pins of the IC. Figure 37 shows the typical board loss for the [ADRF5720-EVALZ](#) evaluation board at room temperature, the embedded insertion loss, and the de-embedded insertion loss for the ADRF5720.

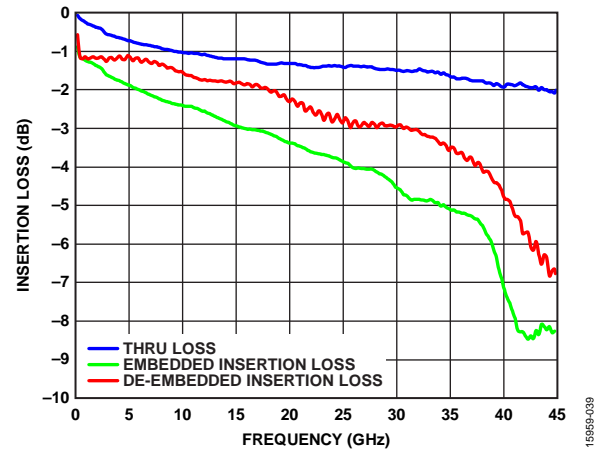

Figure 37. Insertion Loss vs. Frequency

Figure 38 shows the actual ADRF5720 evaluation board with component placement.

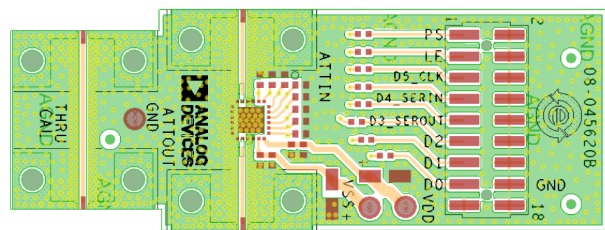

Figure 38. Evaluation Board, Top View

Two power supply ports are connected to the VDD and VSS test points, TP1 and TP2, and the ground reference is connected to the GND test point, TP4. On the supply traces, VDD and VSS, a 100 pF bypass capacitor is used to filter high frequency noise. Additionally, unpopulated components positions are available for applying extra bypass capacitors.

All the digital control pins are connected through digital signal traces to the 2 × 9-pin header, P1. There are provisions for a resistor capacitor (RC) filter that helps eliminate dc-coupled noise. The ADRF5720 was evaluated without an external RC filter, the series resistors are 0 Ω, and the shunt capacitors are unpopulated on the evaluation board.

The RF input and output ports (ATTIN and ATTOUT) are connected through 50 Ω transmission lines to the 2.4 mm RF launchers, J1 and J2, respectively. These high frequency RF launchers are connected by contact and are not soldered onto the board.

A thru calibration line connects the unpopulated J3 and J4 launchers. This transmission line is used to estimate the loss of the PCB over the environmental conditions being evaluated.

The schematic of the [ADRF5720-EVALZ](#) evaluation board is shown in Figure 39.



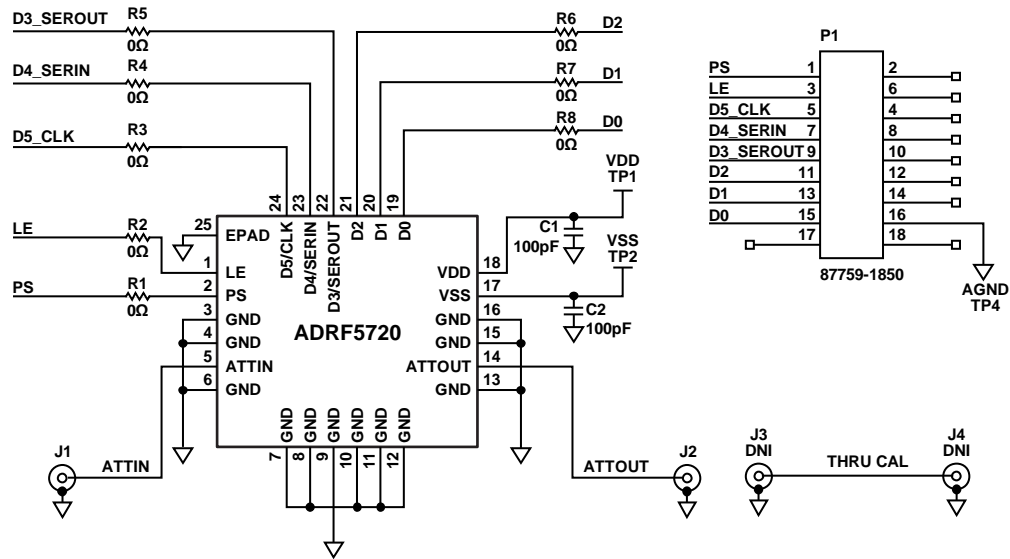

Figure 39. Evaluation Board Schematic

1585P-040

Table 8. Evaluation Board Components

Component	Default Value	Description
C1, C2	100 pF	Capacitors, C0402 package
J1 to J4	Not applicable	2.4 mm end launch connectors (Southwest Microwave: 1492-04A-5)
P1	Not applicable	2 × 9-pin header
R1 to R8	0 Ω	Resistors, 0402 package
TP1, TP2, TP4	Not applicable	Through hole mount test points
U1	ADRF5720	ADRF5720 digital attenuator, Analog Devices, Inc.

**PROBE MATRIX BOARD**

The probe matrix board is a 4-layer board. Similar to the evaluation board, the probe matrix board also uses a 12 mil Rogers RO4003 dielectric. The top and bottom copper layers are 1.5 oz (2.2 mil) plated to 1.5 oz (2.2 mil). The RF transmission lines are designed using a CPWG model with a width of 16 mil and ground spacing of 6 mil to have a characteristic impedance of 50 Ω.

Figure 40 and Figure 41 show the cross sectional view and the top view of the board, respectively. Measurements are made using GSG probes at close proximity to the RF pins (ATTIN and ATTOUT). Unlike the evaluation board, probing reduces reflections caused by mismatch arising from connectors, cables, and board layout, resulting in a more accurate measurement of the device performance.

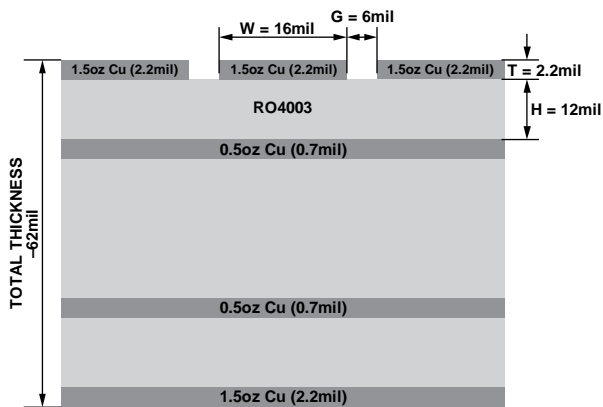

Figure 40. Probe Matrix Board Stackup, Cross Sectional View

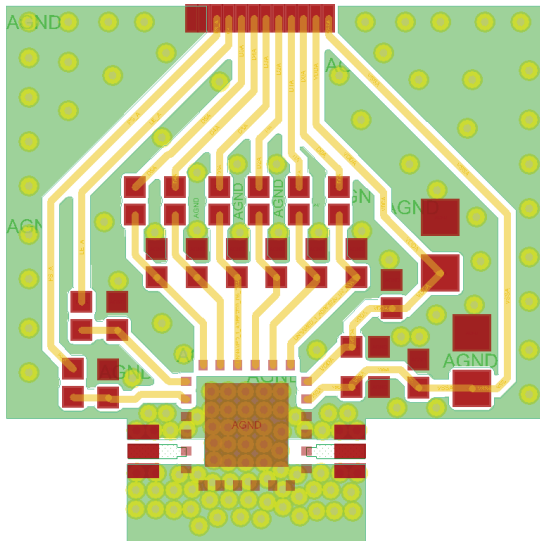

Figure 41. Probe Matrix Board Top View

The probe matrix board includes a thru reflect line (TRL) calibration kit, allowing board loss de-embedding. The actual board duplicates the same layout in matrix form to assemble multiple devices at one time. All S-parameters were measured on this board.

**Impedance Matching**

Impedance matching at the RF pins (ATTIN and ATTOUT) can improve insertion loss, return loss, and attenuation accuracy at high frequencies. Figure 42 and Figure 43 show the difference in the transmission lines at the ATTIN and ATTOUT pins.

The dimensions of the 50 Ω lines are 16 mil trace width and 6 mil gap. To implement this impedance matched circuit, the pad length is extended by 5 mil (from 17 mil to 22 mil). The calibration reference kit does not include the 5 mil matching line and, therefore, the measured insertion loss includes the losses of the matching circuit.

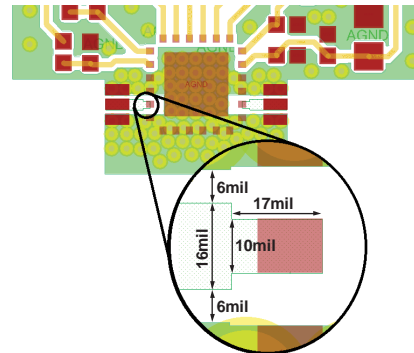

Figure 42. Without Impedance Match

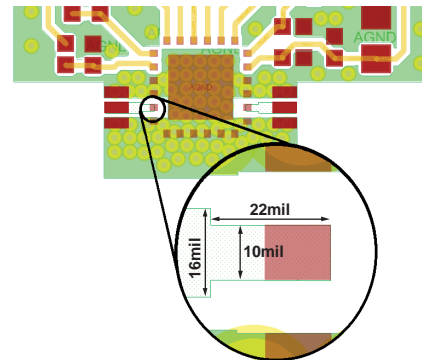

Figure 43. With Impedance Match

### OUTLINE DIMENSIONS

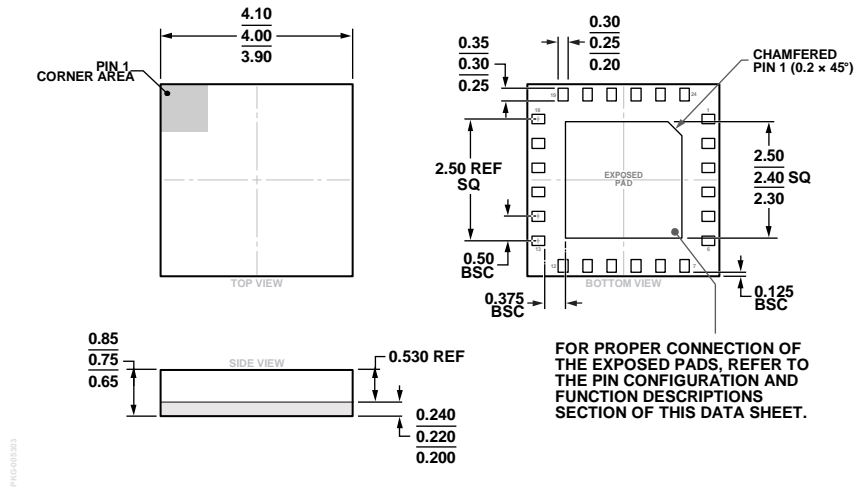

Figure 44. 24-Terminal Land Grid Array [LGA]  
 4 mm x 4 mm Body and 0.75 mm Package Height  
 (CC-24-5)  
 Dimensions shown in millimeters

### ORDERING GUIDE

Model <sup>1</sup>	Temperature Range	Package Description	Package Option
ADRF5720BCCZN	-40°C to +105°C	24-Terminal Land Grid Array [LGA]	CC-24-5
ADRF5720BCCZN-R7	-40°C to +105°C	24-Terminal Land Grid Array [LGA]	CC-24-5
ADRF5720-EVALZ		Evaluation Board	

<sup>1</sup> Z = RoHS Compliant Part.

# Mouser Electronics

Authorized Distributor

Click to View Pricing, Inventory, Delivery & Lifecycle Information:

[Analog Devices Inc.:](#)

[ADRF5720BCCZN-R7](#) [ADRF5720BCCZN](#) [ADRF5720-EVALZ](#)