

TR Series Radial Leaded



Description

Our PolySwitch families of telecommunications and networking devices help meet the growing demand for resettable overcurrent protection. These product families help provide protection against damage caused by power cross and power induction surges as defined in ITU, Telcordia GR1089 and IEC 62368-1. Our offering includes chip, surface-mount and radial-leaded configurations.

Applications

Networking Machines and Systems

- Modems
- Phone sets
- Fax machines
- Phone wall outlets
- Alarm systems
- PBX systems
- MDF modules
- T1/E1 equipment
- Analog and digital line cards
- xDSL modems and splitters
- Powered Ethernet systems
- VoIP (Voice over Internet Protocol) equipment
- LAN, WAN equipment
- Customer premise equipment
- Access network hardware

Additional Information



Resources



Accessories



Samples

Agency Approvals

Agency	Agency File/Certificate Number
	E74889*
	78165*
	72161780*

* See Electrical Characteristic Table for approved part numbers.

Features

- Resettable overcurrent protection
- Fast time-to-trip
- Resistance sorted and matched devices available
- Low parasitic capacitance/flat impedance with frequency
- Recognized to UL 1434, approved to CSA TIL No. CA-3A and EN 60730-1.

Electrical Characteristics

Part Number	Ordering Part Number	I _H (A)	I _T (A)	V _{MAX}		I _{MAX}	P _D TYP (W)	Max Time-to-trip		R _{MIN} (Ω)	R _{MAX} (Ω)	R _{1MAX} (Ω)	Agency Approvals														
				Operating	Interrupt	Interrupt		(s)	(s)				(s)														
				(V _{DC})	(V _{RMS})	(A)		(s)	(s)				(s)														
TRF250 – Radial-leaded* – 250V_{AC}																											
TRF250-055T	RF1968-000	0.055	0.170	60	250	3.0	0.6	0.28	3.5	15.0	25.0	35.0	-	-	-												
TRF250-055UT	RF1647-000	0.055	0.170	60	250	3.0	0.6	0.28	3.0	15.0	25.0	35.0	-	-	-												
TRF250-080T	RF0124-000	0.080	0.160	60	250	3.0	0.6	0.35	4.0	15.0	22.0	33.0	x	x	x												
TRF250-080U	RF0125-000	0.080	0.160	60	250	3.0	0.6	0.35	2.5	14.0	20.0	33.0	x	x	x												
TRF250-110U	RF0126-000	0.110	0.220	60	250	3.0	0.6	1.00	0.8	5.0	9.0	16.0	x	x	x												
TRF250-120	RF0008-000	0.120	0.240	60	250	3.0	0.8	1.00	1.5	4.0	8.0	16.0	x	x	x												
TRF250-120T	RF0013-000	0.120	0.240	60	250	3.0	0.8	1.00	0.7	7.0	12.0	16.0	-	-	-												

TR Series

Radial Leaded

Electrical Characteristics

Part Number	Ordering Part Number	I _H (A)	I _T (A)	V _{MAX}		I _{MAX} (A)	P _D TYP (W)	Max Time-to-trip		R _{MIN} (Ω)	R _{MAX} (Ω)	R _{1MAX} (Ω)	Agency Approvals			
				Operating	Interrupt			(A)	(s)				UL	SP	A	
				(V _{DC})	(V _{RMS})											
TRF250 – Radial-leaded* – 250V_{AC}																
TRF250-120T-RA-B-0.5	RF0016-000	0.120	0.240	60	250	3.0	0.8	1.00	1.2	7.0	9.0	16.0	—	—	—	
TRF250-120T-RC-B-0.5	RF0361-000	0.130	0.260	60	250	3.0	0.8	1.00	3.0	5.4	7.5	14.0	—	—	—	
TRF250-120T-RF-B-0.5	RF0105-000	0.120	0.240	60	250	3.0	0.8	1.00	0.9	6.0	10.5	16.0	—	—	—	
TRF250-120T-RH-B-0.5	RF2519-000	0.120	0.240	60	250	3.0	0.8	1.00	0.7	9.0	11.0	16.0	—	—	—	
TRF250-120T-R1-B-0.5	RF0015-000	0.120	0.240	60	250	3.0	0.8	1.00	0.7	6.0	9.0	16.0	—	—	—	
TRF250-120T-R2-B-0.5	RF0425-000	0.120	0.240	60	250	3.0	0.8	1.00	0.8	8.0	10.5	16.0	—	—	—	
TRF250-120U	RF0017-000	0.120	0.240	60	250	3.0	0.7	1.00	1.0	6.0	10.0	16.0	x	x	x	
TRF250-120UT	RF0018-000	0.120	0.240	60	250	3.0	0.7	1.00	0.7	7.0	12.0	16.0	—	—	—	
TRF250-145	RF0021-000	0.145	0.290	60	250	3.0	0.8	1.00	2.5	3.0	6.0	14.0	x	x	x	
TRF250-145-RA-B-0.5	RF0044-000	0.145	0.290	60	250	3.0	0.8	1.00	2.5	3.0	6.0	12.0	—	—	—	
TRF250-145T	RF0022-000	0.145	0.290	60	250	3.0	0.8	1.00	1.5	5.4	7.5	14.0	—	—	—	
TRF250-145U	RF0027-000	0.145	0.290	60	250	3.0	0.7	1.00	2.0	3.5	6.5	14.0	x	x	x	
TRF250-180	E46226-000	0.180	0.650	100	250	10.0	0.9	3.00	0.5	0.8	2.2	4.0	x	x	x	
TRF250-183 [†]	RF0768-000	0.183	0.685	100	250	10.0	0.9	3.00	0.6	0.8	2.0	3.4	x	x	x	
TRF250-183U [†]	RF0770-000	0.183	0.685	100	250	10.0	0.9	3.00	0.6	0.8	2.0	3.4	x	x	x	
TRF250-184 [‡]	RF1135-000	0.184	1.000	100	250	10.0	0.9	3.00	0.5	1.2	2.4	3.1	x	x	x	
TRF600 – Radial-leaded[†] – 600V_{AC}																
TRF600-150	A87878-000	0.150	0.300	250	600	3.0	1.4	1.0	1.4	6.0	10.0	17.0	x	x	x	
TRF600-150-RB	F95456-000	0.150	0.300	250	600	3.0	1.4	1.0	1.0	9.0	12.0	22.0	—	—	—	
TRF600-150-R2-B-0.5	RF0023-000	0.150	0.300	250	600	3.0	1.4	1.0	1.3	7.0	10.0	17.0	—	—	—	
TR600-150F-EX	RF1302-000	0.150	0.300	250	600	3.0	1.4	1.0	5.0	6.0	12.0	22.0	—	—	—	
TR600-150F-EX-RB	RF3620-000	0.150	0.300	250	600	3.0	1.4	1.0	5.0	9.0	12.0	22.0	—	—	—	
TRF600-160	RF0071-000	0.160	0.320	250	600	3.0	1.7	1.0	7.5	4.0	10.0	18.0	x	x	x	
TRF600-160-RA	RF0170-000	0.160	0.320	250	600	3.0	1.7	1.0	9.5	4.0	7.0	16.0	—	—	—	
TRF600-250	RF1926-000	0.250	0.850	250	600	3.0	2.0	3.0	1.0	1.0	4.3	7.0	x	x	x	
TRF600-400	RF0965-000	0.400	1.000	60	600	3.0	2.4	3.0	4.0	0.95	1.45	1.90	x	x	x	

Notes:

I_H : Hold current: maximum current device will pass without interruption in 20°C still air.

I_T : Trip current: minimum current that will switch the device from low resistance to high resistance in 20°C still air.

V_{MAX} Operating : Maximum continuous voltage device can withstand without damage at rated current. This voltage is used for component Recognition under UL1434.

V_{MAX} Interrupt : Maximum voltage that can be safely placed across a device in its tripped state.

I_{MAX} Interrupt : Maximum fault current device can withstand without damage at rated operating voltage. This current is used for component Recognition under UL1434. Devices may trip safely under higher level power cross conditions to assist equipment in meeting the appropriate ITU, UL60950 or GR1089 industry requirements.

P_D : Power dissipated from device when in the tripped state in 20°C still air.

R_{MIN} : Minimum resistance of device as supplied at 20°C unless otherwise specified.

R_{MAX} : Maximum resistance of device as supplied at 20°C unless otherwise specified.

R_{1MAX} : Maximum resistance measured one hour post-trip or post-reflow at 20°C.

* 250V_{AC} interrupt products may help equipment pass ITU K.20, K.21 and K.45 recommendations and Telcordia GR-1089 Port Type 2 and 4 requirements.

† 600V_{AC} interrupt products may help equipment pass UL60950, TIA-968-A and GR1089 Port Type 1, 3 and 5 requirements.

‡ Product is not currently available in a resistance matched or sorted option.

TR Series

Radial Leaded

Temperature Derating

Maximum Ambient Temperature									
Part Number	-40°C	-20°C	0°C	20°C	40°C	50°C	60°C	70°C	85°C
Hold Current (A)									
TRF250 – Radial-leaded – 250V _{AC}									
TRF250-055T	0.085	0.076	0.065	0.055	0.045	0.041	0.035	0.030	0.023
TRF250-055UT	0.085	0.076	0.065	0.055	0.045	0.041	0.035	0.030	0.023
TRF250-080T	0.124	0.110	0.095	0.080	0.066	0.059	0.051	0.044	0.033
TRF250-080U	0.124	0.110	0.095	0.080	0.066	0.059	0.051	0.044	0.033
TRF250-110U	0.171	0.151	0.131	0.110	0.091	0.081	0.071	0.061	0.046
TRF250-120	0.186	0.165	0.143	0.120	0.099	0.088	0.077	0.066	0.050
TRF250-120T	0.186	0.165	0.143	0.120	0.099	0.088	0.077	0.066	0.050
TRF250-120U	0.186	0.165	0.143	0.120	0.099	0.088	0.077	0.066	0.050
TRF250-120UT	0.186	0.165	0.143	0.120	0.099	0.088	0.077	0.066	0.050
TRF250-145	0.225	0.199	0.172	0.145	0.119	0.106	0.093	0.080	0.060
TRF250-145T	0.225	0.199	0.172	0.145	0.119	0.106	0.093	0.080	0.060
TRF250-145U	0.225	0.199	0.172	0.145	0.119	0.106	0.093	0.080	0.060
TRF250-180	0.279	0.247	0.213	0.180	0.147	0.131	0.115	0.099	0.074
TRF250-183 [‡]	0.284	0.251	0.217	0.183	0.149	0.133	0.117	0.101	0.075
TRF250-183U [†]	0.284	0.251	0.217	0.183	0.149	0.133	0.117	0.101	0.075
TRF250-184 [‡]	0.286	0.252	0.218	0.184	0.150	0.134	0.118	0.102	0.075
TRF600 – Radial-leaded [†] – 600V _{AC}									
TRF600-150	0.239	0.209	0.180	0.150	0.121	0.107	0.093	0.079	0.057
TR600-150F-EX	0.239	0.209	0.180	0.150	0.121	0.107	0.093	0.079	0.057
TRF600-160	0.255	0.223	0.192	0.160	0.129	0.114	0.099	0.084	0.061
TRF600-250	0.400	0.350	0.300	0.250	0.198	0.170	0.140	0.117	0.083
TRF600-400	0.640	0.560	0.480	0.400	0.320	0.270	0.230	0.190	0.130

† 600V_{AC} interrupt products may help equipment pass UL60950, TIA-968-A and GR1089 Port Type 1, 3 and 5 requirements.

‡ Product is not currently available in a resistance matched or sorted option.

Temperature Derating Curve

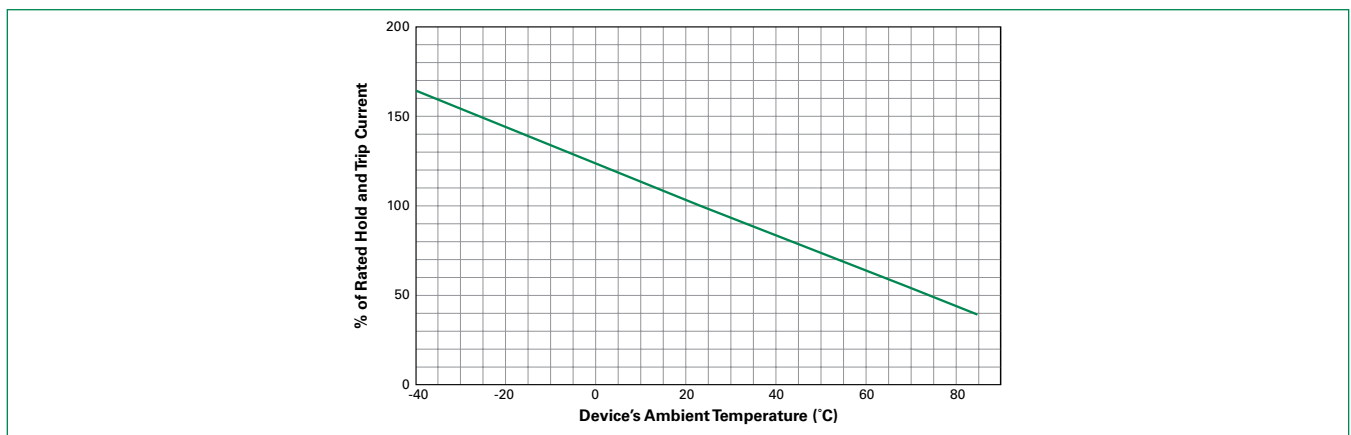

TR Series

Radial Leaded

Typical Time-to-Trip Curves at 25°C

TRF250

- A = TRF250-180/183/183U/184
- B = TRF250-145/145U/145T
- C = TRF250-120/120U
- D = TRF250-110U/120UT/120T
- E = TRF250-080T/080U
- F = TRF250-055T/055UT

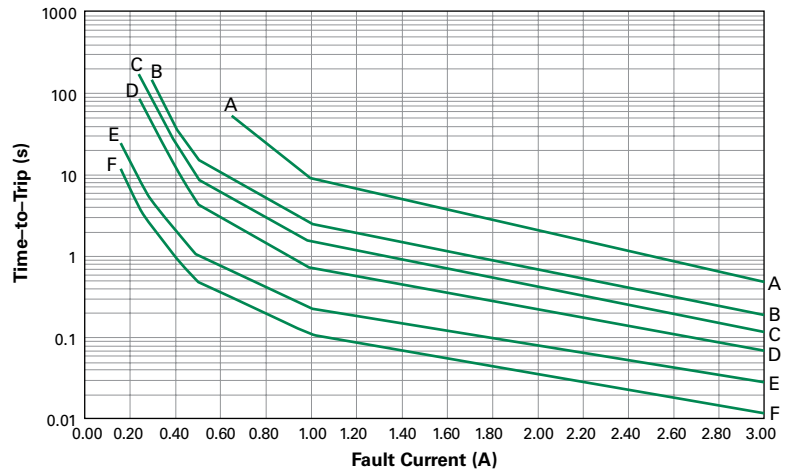

TRF600

- A = TRF600-400
- B = TRF600-250
- C = TRF600-160
- D = TR600-150F-EX
- E = TRF600-150

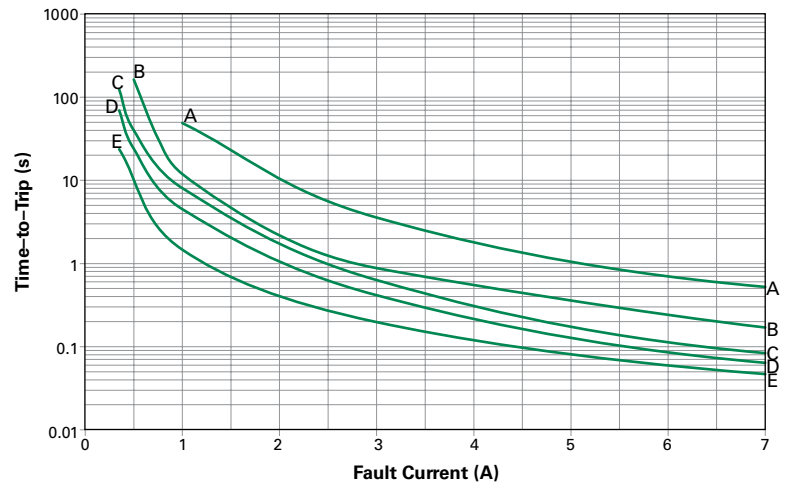

TR Series

Radial Leaded

TRF250/ TRF600 – Physical Specifications

Lead Material	Tin-plated Copper, 22AWG
Insulating Material	Cured Epoxy Polymer that meets UL 94 V-0 flammability rating
Soldering Characteristics	ANSI/J-STD-002, Category 3
Solder Heat Withstand	IEC 60068-2-20, Test Tb, Section 5 Method 1

Note: Devices are not intended to be placed through a reflow process.

TRF250/ TRF600 – Environmental Specifications

Test	Conditions
Passive Aging	60°C, 1000 hrs 85°C, 1000 hrs
Humidity Aging	85°C, 85% R.H., 1000 hrs
Thermal Shock	125°C, -55°C (10 Times)
Solvent Resistance	MIL-STD-202, Method 215F
Moisture Resistance Level	Level 1, J-STD-020
Storage Conditions	40°C max, 70% RH max; devices should remain in original sealed bags prior to use. Devices may not meet specified values if these storage conditions are exceeded.

Note: Storage conditions: 40°C (max), 70% RH (max), devices should remain in original sealed bag prior to use.
Devices may not meet specified values if these storage conditions are exceeded.

Part Ordering Number System

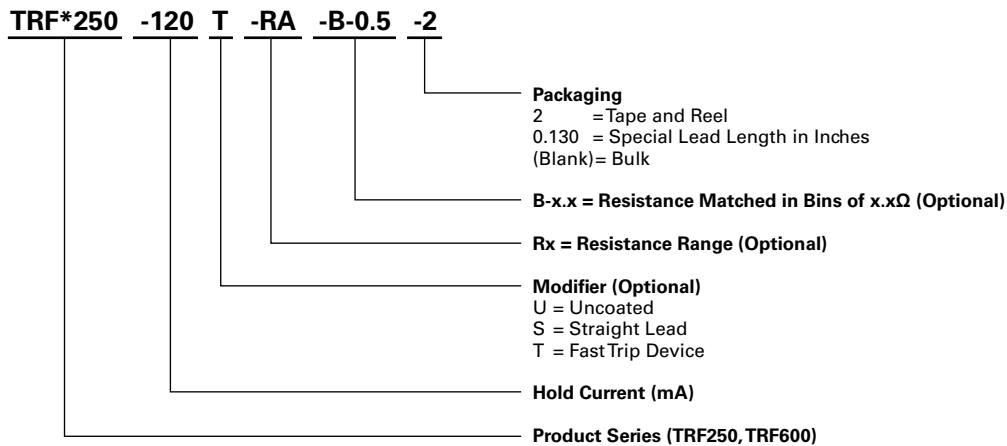

* F = RoHS compliant, ELV compliant

TR Series Radial Leaded

Dimension Figures

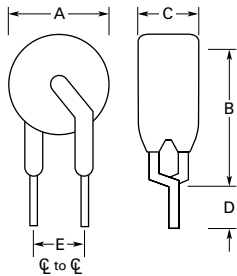

Figure 1

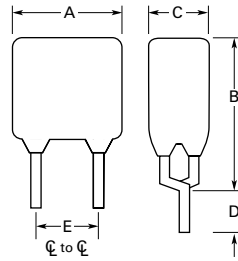

Figure 2

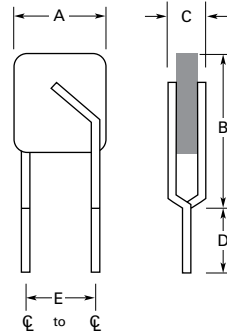

Figure 3

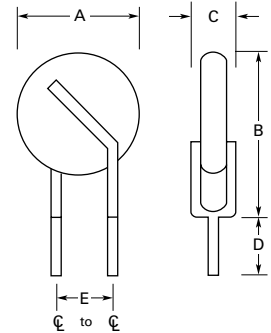

Figure 4

Dimensions and Weights

Part Number	Dimensions in Millimeters (Inches)												Figure	Device Mass (g) (Only for Reference)
	A		B		C		D		E		F			
	Min	Max	Min	Max	Min	Max	Min	Max	Min	Max	Min	Max		
TRF250 – Radial-leaded* – 250V_{AC}														
TRF250-055T	—	5.8 (0.23)	—	9.9 (0.39)	—	4.6 (0.18)	4.7 (0.19)	—	5.0 [‡] (0.20)	—	—	—	1	0.28
TRF250-055UT	—	4.8 (0.19)	—	9.3 (0.37)	—	3.8 (0.15)	4.7 (0.19)	—	5.0 [‡] (0.20)	—	—	—	4	0.13
TRF250-080T	—	5.8 (0.23)	—	9.9 (0.39)	—	4.6 (0.18)	4.7 (0.19)	—	5.0 [‡] (0.20)	—	—	—	1	0.28
TRF250-080U	—	4.8 (0.19)	—	9.3 (0.37)	—	3.8 (0.15)	4.7 (0.19)	—	5.0 [‡] (0.20)	—	—	—	4	0.13
TRF250-110U	—	5.3 (0.21)	—	9.4 (0.37)	—	3.8 (0.15)	4.7 (0.19)	—	5.0 [‡] (0.20)	—	—	—	4	0.13
TRF250-120	—	6.5 (0.26)	—	11.0 (0.43)	—	4.6 (0.18)	4.7 (0.19)	—	5.0 [‡] (0.20)	—	—	—	2	0.38
TRF250-120T	—	6.5 (0.26)	—	11.0 (0.43)	—	4.6 (0.18)	4.7 (0.19)	—	5.0 [‡] (0.20)	—	—	7.0 (0.28)	2	0.38
TRF250-120U	—	6.0 (0.24)	—	10.0 (0.39)	—	3.8 (0.15)	4.7 (0.19)	—	5.0 [‡] (0.20)	—	—	6.0 (0.24)	3	0.19
TRF250-120UT	—	6.0 (0.24)	—	10.0 (0.39)	—	3.8 (0.15)	4.7 (0.19)	—	5.0 [‡] (0.20)	—	—	6.0 (0.24)	3	0.19
TRF250-145	—	6.5 (0.26)	—	11.0 (0.43)	—	4.6 (0.18)	4.7 (0.19)	—	5.0 [‡] (0.20)	—	—	7.0 (0.28)	2	0.38
TRF250-145T	—	6.5 (0.26)	—	11.0 (0.43)	—	4.6 (0.18)	4.7 (0.19)	—	5.0 [‡] (0.20)	—	—	7.0 (0.28)	2	0.38
TRF250-145U	—	6.0 (0.24)	—	10.0 (0.39)	—	3.8 (0.15)	4.7 (0.19)	—	5.0 [‡] (0.20)	—	—	6.0 (0.24)	3	0.19
TRF250-180	—	9.0 (0.35)	—	12.0 (0.47)	—	3.8 (0.15)	4.7 (0.19)	—	5.0 [‡] (0.20)	—	—	—	1	0.35
TRF250-183	—	7.5 (0.29)	—	10.5 (0.41)	—	3.8 (0.15)	4.7 (0.19)	—	5.0 [‡] (0.20)	—	—	—	1	0.30
TRF250-183U	—	6.5 (0.26)	—	10.0 (0.39)	—	3.0 (0.12)	4.7 (0.19)	—	5.0 [‡] (0.20)	—	—	—	4	0.16
TRF250-184	—	7.7 (0.30)	—	10.5 (0.41)	—	4.6 (0.18)	4.7 (0.19)	—	5.0 [‡] (0.20)	—	—	—	1	0.32

* 250V_{AC} interrupt products may help equipment pass ITU K.20, K.21 and K.45 recommendations and Telcordia GR-1089 Port Type 2 and 4 requirements.

‡ Indicates dimension is typical, not minimum.

TR Series

Radial Leaded

Dimension Figures

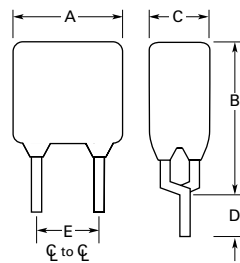

Figure 1

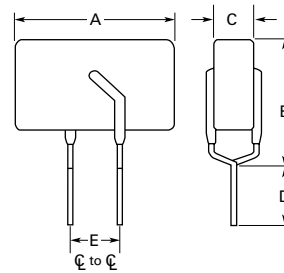

Figure 2

Dimensions and Weights

Part Number	Dimensions in Millimeters (Inches)												Figure	Device Mass (g) (Only for Reference)
	A		B		C		D		E		F			
	Min	Max	Min	Max	Min	Max	Min	Max	Min	Max	Min	Max		
TRF600 – Radial-leaded – 600V_{AC}														
TRF600-150	—	9.0 (0.35)	—	12.5 (0.49)	—	4.6 (0.18)	4.7 (0.19)	—	5.0 (0.20)	—	—	9.0 (0.35)	1	0.37
TR600-150F-EX	—	13.5 (0.53)	—	12.6 (0.50)	—	6.0 (0.24)	4.7 (0.19)	—	5.0 (0.20)	—	—	—	2	0.80
TRF600-160	—	16.0 (0.63)	—	12.6 (0.50)	—	6.0 (0.24)	4.7 (0.19)	—	5.0 [‡] (0.20)	—	—	10.0 (0.39)	2	0.90
TRF600-250	—	15.0 (0.59)	—	14.5 (0.57)	—	4.6 (0.18)	4.7 (0.19)	—	5.0 [‡] (0.20)	—	—	10.0 (0.39)	1	0.87
TRF600-400	—	14.8 (0.58)	—	13.1 (0.52)	—	4.6 (0.18)	6.0 (0.27)	—	5.0 [‡] (0.20)	—	—	—	2	0.85

‡ Indicates dimension is typical, not minimum.

Wave Soldering Recommendations

Recommended Wave Soldering

- Soldering temperature profile
Temperature characteristic at component terminal with dual wave soldering

Rework

- If a device is removed from the board, it should be discarded and replaced with a new device

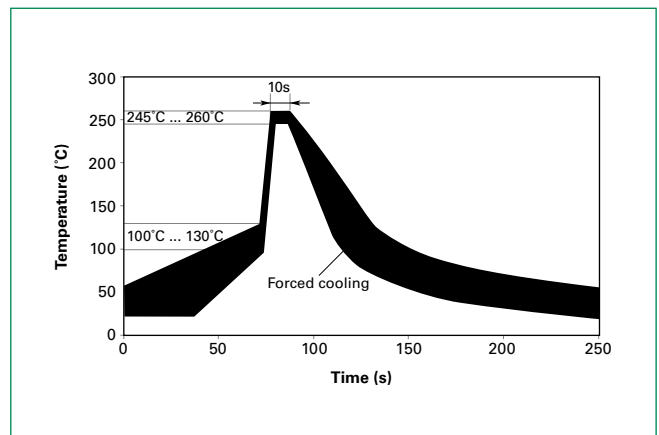

TR Series

Radial Leaded

Packaging and Marking Information

Part Number	Bag Quantity	Tape and Reel Quantity	Standard Package Quantity	Part Marking	Agency Approvals
TRF250 – Radial-leaded – 250V_{Ac}					
TRF250-055T	500	—	10,000	05F	—
TRF250-055UT	500	—	10,000	—	—
TRF250-080U	500	—	10,000	—	UL, CSA, TÜV
TRF250-080T	500	—	10,000	08F	UL, CSA, TÜV
TRF250-110U	500	—	10,000	—	UL, CSA, TÜV
TRF250-120	500	—	10,000	20F	UL, CSA, TÜV
TRF250-120-2	—	1,500	7,500	20F	UL, CSA, TÜV
TRF250-120T	500	—	10,000	20F	—
TRF250-120T-2	—	1,500	7,500	20F	—
TRF250-120U	500	—	10,000	—	UL, CSA, TÜV
TRF250-120U-2	—	1,500	7,500	—	UL, CSA, TÜV
TRF250-120UT	500	—	10,000	—	—
TRF250-145	500	—	10,000	45F	UL, CSA, TÜV
TRF250-145-2	—	1,500	7,500	45F	UL, CSA, TÜV
TRF250-145T	500	—	10,000	45F	—
TRF250-145T-2	—	1,500	7,500	45F	—
TRF250-145U	500	—	10,000	—	UL, CSA, TÜV
TRF250-145U-2	—	1,500	7,500	—	UL, CSA, TÜV
TRF250-180	500	—	10,000	80F	UL, CSA, TÜV
TRF250-180-2	—	1500	7,500	80F	UL, CSA, TÜV
TRF250-183	500	—	10,000	83F	UL, CSA, TÜV
TRF250-183-2	—	1,500	7,500	83F	UL, CSA, TÜV
TRF250-183U	500	—	10,000	—	UL, CSA, TÜV
TRF250-184	500	—	10,000	84F	UL, CSA, TÜV
TRF600 – Radial-leaded – 600V_{Ac}					
TRF600-150	500	—	10,000	150F	UL, CSA, TÜV
TRF600-150-2	—	1,500	7,500	150F	UL, CSA, TÜV
TR600-150F-EX	500	—	10,000	150F	—
TR600-150F-EX-2	—	600	3,000	150F	—
TRF600-160	500	—	10,000	160F	UL, CSA, TÜV
TRF600-160-2	—	600	3,000	160F	UL, CSA, TÜV
TRF600-250	500	—	10,000	250F	UL, CSA, TÜV
TRF600-400	500	—	10,000	400F	UL, CSA, TÜV

TR Series

Radial Leaded

Tape and Reel Specifications

TRF250/TRF600 devices are available in tape and reel packaging per EIA 468-B standard. See Figures 1 and 2 for details.

Description	EIA Mark	IEC Mark	Dimension (mm)	Tolerance
Carrier Tape Width	W	W	18	-0.5/+1.0
Hold Down Tape Width	W ₄	W ₀	5	Min
Top Distance between Tape Edges	W ₆	W ₂	3	Max
Sprocket Hole Position	W ₅	W ₁	9	-0.5/+0.75
Sprocket Hole Diameter	D ₀	D ₀	4	±0.2
Abcissa to Plane (Straight Lead)	H	H	18.5	±3.0
Abcissa to Plane (Kinked Lead)*	H ₀	H ₀	16	-0.5/+0.6
Abcissa to Top	H ₁	H ₁	32.2	Max
Overall Width with Lead Protrusion	—	C ₁	43.2	Max
Overall Width without Lead Protrusion	—	C ₂	42.5	Max
Lead Protrusion	L ₁	I ₁	1.0	Max
Protrusion of Cut-out	L	L	11	Max
Protrusion beyond Hold Down Tape	I ₂	I ₂	Not Specified	—
Sprocket Hole Pitch	P ₀	P ₀	12.7	±0.3
Device Pitch (TRF250 and TRF600-150)	—	—	12.7	—
Device Pitch (TRF600-160 - TRF600-400)	—	—	25.4	—
Pitch Tolerance	—	—	20 Consecutive	±1
Tape Thickness	t	t	0.9	Max
Tape Thickness with Splice*	t ₁	—	2.0	Max
Splice Sprocket Hole Alignment	—	—	0	±0.3
Body Lateral Deviation	Dh	Dh	0	±1.0
Body Tape Plane Deviation	Dp	Dp	0	±1.3
Lead Spacing Plane Deviation	DP ₁	P ₁	0	±0.7
Lead Spacing*	F	F	5.08	±0.6
Reel Width	w ₂	w	56	Max
Reel Diameter	a	d	370	Max
Space between Flanges Less Device	w ₁	—	4.75	±3.25
Arbor Hole Diameter	c	f	26	±12.0
Core Diameter	n	h	80	Max
Box	—	—	56/372/372	Max
Consecutive Missing Pieces*	—	—	3 Max	—
Empty Places per Reel*	—	—	Not Specified	—

* Differs from EIA specification.

TR Series Radial Leaded

Tape and Reel Diagrams

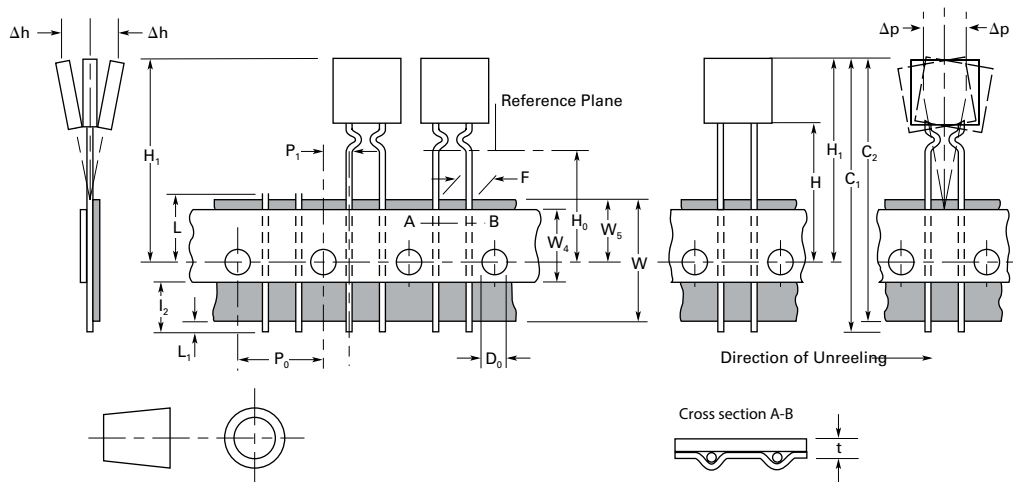

Figure 1

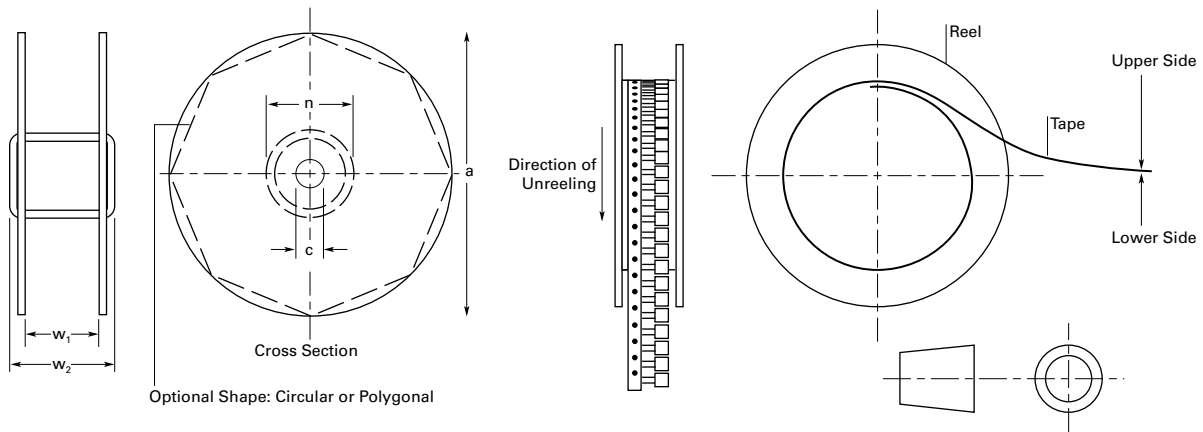

Figure 2

Warning

- Users should independently evaluate the suitability of and test each product selected for their own application.
- Operation beyond the maximum ratings or improper use may result in device damage and possible electrical arcing and flame.
- These devices are intended for protection against damage caused by occasional overcurrent or overtemperature fault conditions and should not be used when repeated fault conditions or prolonged trip events are anticipated.
- Contamination of the PPTC material with certain silicone-based oils or some aggressive solvents can adversely impact the performance of the devices.
- Device performance can be impacted negatively if devices are handled in a manner inconsistent with recommended electronic, thermal, and mechanical procedures for electronic components.
- PPTC devices are not recommended for installation in applications where the device is constrained such that its PTC properties are inhibited, for example in rigid potting materials or in rigid housings, which lack adequate clearance to accommodate device expansion.
- Operation in circuits with a large inductance can generate a circuit voltage (Ldi/dt) above the rated voltage of the device.

Disclaimer Notice - Information furnished is believed to be accurate and reliable. However, users should independently evaluate the suitability of and test each product selected for their own applications. Littelfuse products are not designed for, and may not be used in, all applications. Read complete Disclaimer Notice at www.littelfuse.com/disclaimer-electronics.