

1: Card Guides

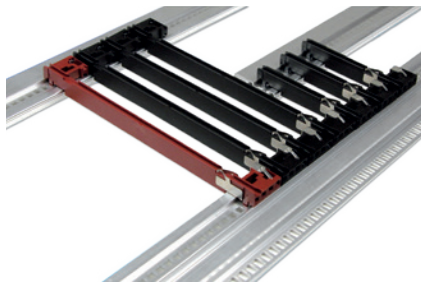
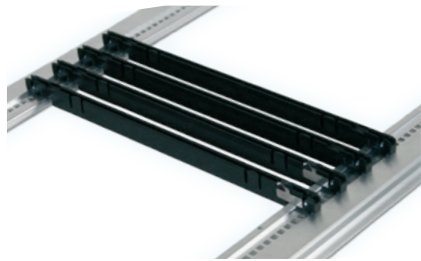

1.1 Card Guides Standard acc. to IEC

E | 1_3

1.1.1 Card Guides 1-Slot

E | 1_3

1.1.2 Card Guides 7-Slot in 4 HP Steps

E | 1_4

1.1.3 Card Guides 1-Slot, 3 Parts

E | 1_4

1.1.4 Card Guide Board-Retention Bar

E | 1_4

1.2 Rugged Screw mount Card Guides acc. to IEC

E | 1_5

1.2.1 Standard Mounting

E | 1_6

1.2.2 Optional Mounting

E | 1_6

1.2.3 ESD Clips

E | 1_6

1.3 Card Guides Standard acc. to IEEE

E | 1_7

1.3.1 Card Guides 1-Slot

E | 1_7

1.3.2 Card Guides 1-Slot, incl. mounted ESD-Components

E | 1_8

1.3.3 Aluminium Card Guides 1-Slot, 3 Parts

E | 1_8

1.3.4 ESD Clips

E | 1_9

1.3.5 ESD Spring

E | 1_9

1.3.6 Coding Pins

E | 1_9

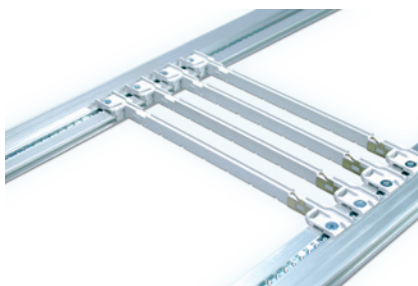
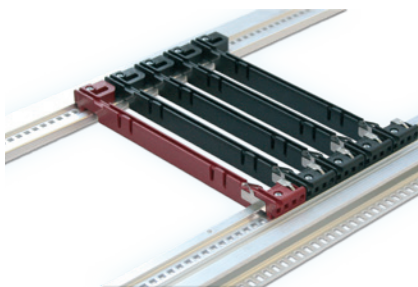

1.4 Rugged Screw-mount Card Guides acc. to IEEE

E | 1_10

1.4.1 Standard Mounting

E | 1_10

1.4.2 Optional Mounting

E | 1_11

1.4.3 ESD Clips

E | 1_11

1.4.4 ESD Spring

E | 1_11

1.4.5 Coding Pins

E | 1_11

1.5 uTCA Components

E | 1_12

1.5.1 uTCA Extrusion

E | 1_12

1.5.2 uTCA Card Guide

E | 1_13

1.5.3 uTCA ESD Clip

E | 1_13

1.5.4 Tapped Strips M3

E | 1_13

1.5.5 Countersunk Screw M3 x 6 mm

E | 1_14

1: Card Guides

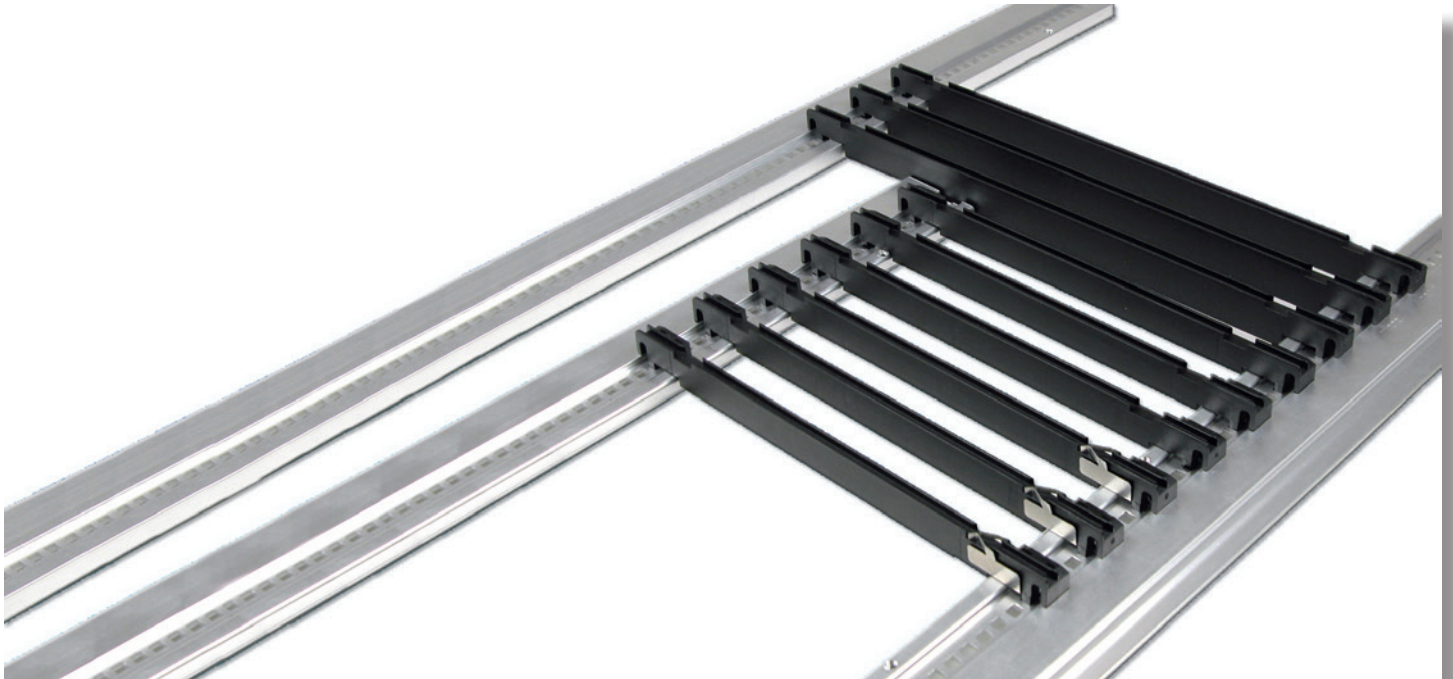

1.1 Card Guides Standard acc. to IEC

- For positive location of circuit boards and plug-in units conforming to the dimensions of card depths 80 mm, 160 mm, 220 mm and 280 mm
- The card guides are non-flammable, made from a high quality plastic material reinforced with fibreglass (UL94 V-0)
- Including ESD provisions

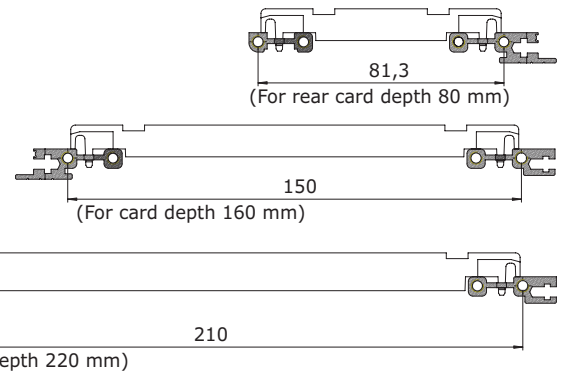

1.1.1 Card Guides 1-Slot



1.1.1 Card Guides 1-Slot

- **Scope of delivery:**
 - Card guide black plastic UL94 V-0
 - ESD Clip see below (not usable for card depth 80 mm)

Card Thickness		Card Depth		Part-No.
mm	inch	mm	inch	
1.6	0.06	80	3.15	61-019
		160	6.30	61-044
		220	8.66	61-039
		280	11.02	61-017
2.0	0.08	160	6.30	61-087
		220	8.66	61-039
		280	11.02	61-169

ESD Clips

- Connecting PCB with case

Description	Part-No.
ESD clip front bottom/rear top	61-419-01
ESD clip front top/rear bottom	61-419-02



1: Card Guides

1.1.2 Card Guides 7-Slot in 4 HP Steps



1.1.2 Card Guides 7-Slot in 4 HP Steps

- For reduced assembly time of multiple slot applications
- For use with single, double and triple eurocards with a depth of 160 mm
- For card thickness: 1.6 mm / 0.06"
- Black plastic, UL94 V-0
- ESD Clip not usable

Card Thickness		Card Depth		Part-No.
mm	inch	mm	inch	
1.6	0.06	160	6.30	61-076

1.1.3 Card Guides 1-Slot, 3 Parts



1.1.3 Card Guides 1-Slot, 3 Parts

- Extrusion: Aluminium / Plastic ABS, (UL 94 V-O)
- End feet: plastic, UL94 HB
- For card thickness: 1.6 mm / 0.06"
- Card guide extrusion, single, clear anodised or plastic grey
- ESD clip not usable

Extrusion

Card Depth		Length		Part-No. Plastic	Part-No. Aluminium
mm	inch	mm	inch		
160	6.30	112.5	4.43	61-051	66-122-20
220	8.66	172.5	6.79	61-052	66-122-21
280	11.02	232.5	9.15	61-053*	66-122-22
340	13.38	292.5	11.51	61-054*	66-122-23
400	15.74	352.5	13.87	61-055*	66-122-24
-	-	1350	53.15	61-059	66-122-14

End Feet

Description	Part-No. 1 Pair
End feet plastic, UL94 HB	61-069

* Card guides must be supported in the middle by an additional extrusion (66-138)

1.1.4 Card Guide Board-Retention Bar

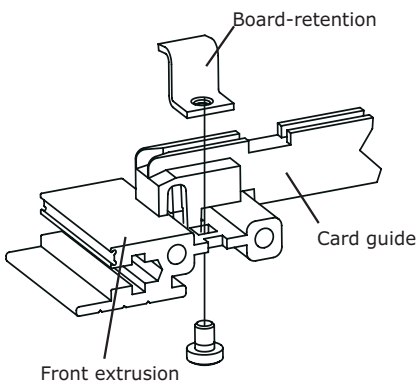

1.1.4 Card Guide Board-Retention Bar

Description	Part-No. 20 pcs.
Board-retention bar, zinc-plated steel	61-291

Assembly Material

Description	Part-No.
Cross recessed round head screw M3 x 4	5331-04
Torx cylinder head screw M3 x 4, size T10	5470-01

1: Card Guides

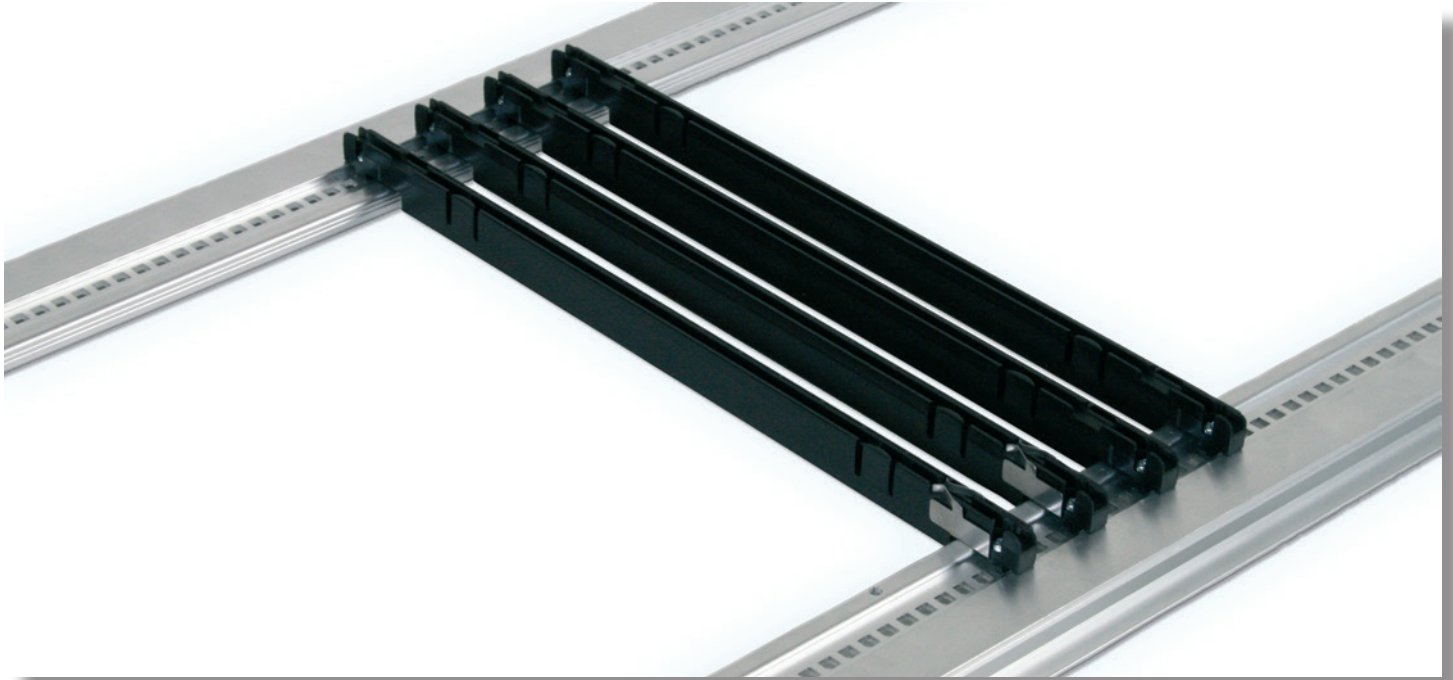

1.2 Rugged Screw mount Card Guides acc. to IEC

- Simple assembly comparable to anchoring
- Very high retention force
- Shock and vibration proof
- For positive location of circuit boards and plug-in units
- For card thickness 1.6 mm / 0.06" and 2.0 mm/0.08" with anti-vibration feature
- The card guides are nonflammable, made from a high-quality plastic material reinforced with fibreglass (UL94 V-0)
- With ESD provision
- Stainless steel PT-screw, Torque: 0,36 Nm

1.2 Rugged Screw mount Card Guides acc. to IEC

- **Scope of delivery:**
 - Card guide, plastic UL94 V-0
- Security screw see 1.2.1 (at least one must be used)
- Optional mounting see 1.2.2
- ESD clip see 1.2.3

Card Depth		Colour	Part-No.
mm	inch		
160	6.30	black	61-975
220	8.66	black	61-976



1: Card Guides

1.2.1 Standard Mounting



1.2.1 Standard Mounting

- With Stainless Steel Security Screw (from Top)

Description	Part-No.
Cross recessed pan head screw, Inox	5588-08

Note: For highest security 2 screws/card guide are necessary.

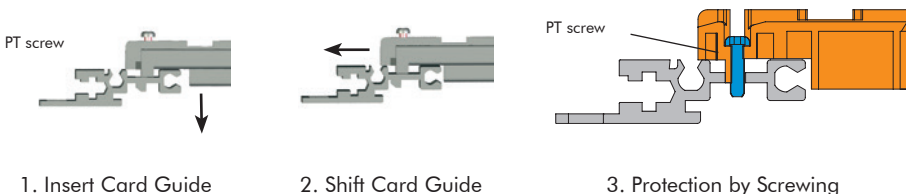

1.2.2 Optional Mounting



1.2.2 Optional Mounting

- With M2 screw, washer and nut (from Bottom)

Description	Part-No. 1 set (1 each)	Part-No.
Cross recessed pan head screw M2, Inox	63-485	5304-13
Hexagonal nut M2 Inox		5620-12
Serrated lock washer		5708-12

Note: For highest security 2 sets/card guide are necessary.



1.2.3 ESD Clips



1.2.3 ESD Clips

- Connecting PCB with case

Description	Part-No.
ESD clip front bottom/rear top	61-419-01
ESD clip front top/rear bottom	61-419-02

**Our ability to adapt existing components to your application,
makes Elma your preferred solution partner.**

1: Card Guides

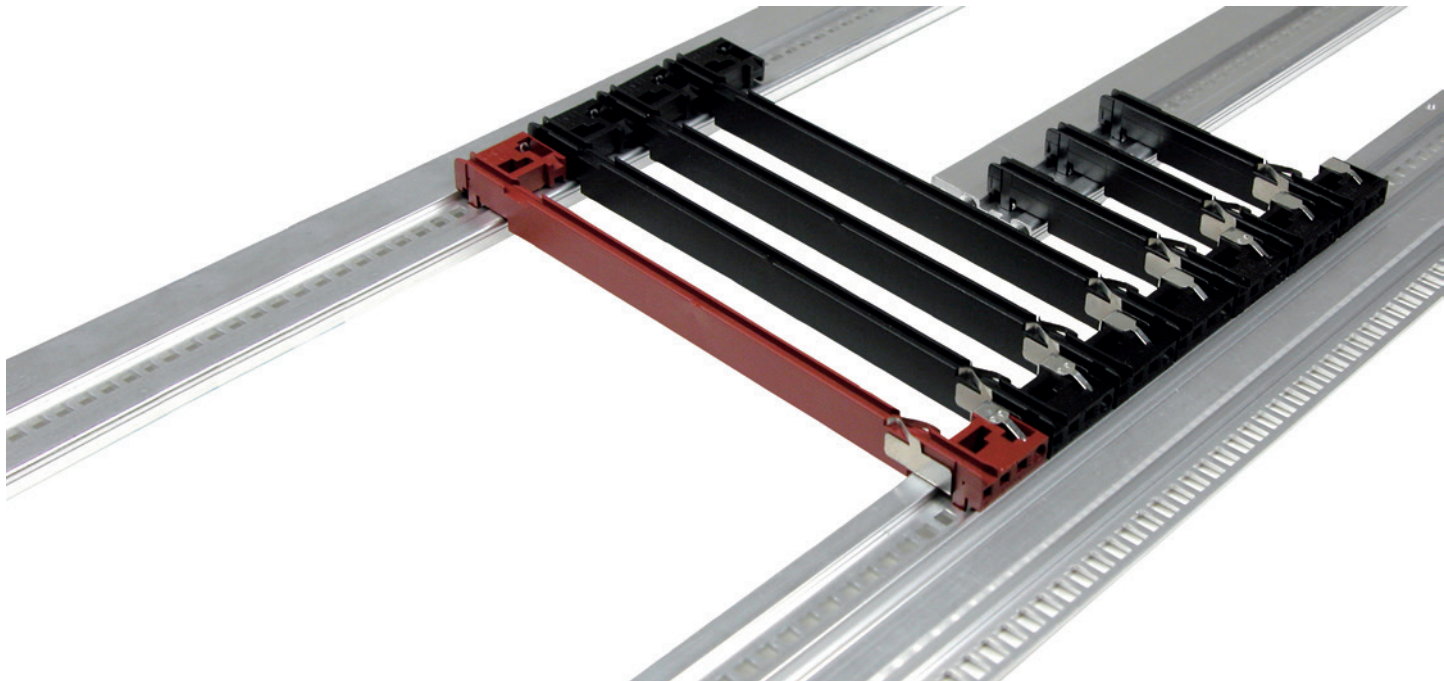

1.3 Card Guides Standard acc. to IEEE

- For positive location of PCBs and plug-in units conforming to the dimensions of card depths 80 mm, 160 mm, 220 mm, 280 mm and 340 mm
- The card guides are nonflammable, made from a high quality plastic material reinforced with fibreglass (UL94 V-0)
- With ESD provisions
- With keying and alignment pin possibilities

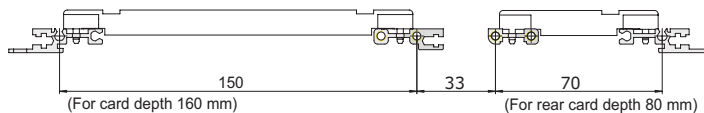

1.3.1 Card Guides 1-Slot

- Card thickness 1.6 mm / 0.06" and 2.0 mm / 0.08"
- Plastic UL94 V-0



1.3.1 Card Guides 1-Slot

Card Depth		Colour	Part-No. 1 Pair
mm	inch		
80	3.15	black	61-949-01
Card Depth		Colour	Part-No.
mm	inch		
160	6.30	black	61-950-01
160	6.30	red	61-950-03

1: Card Guides

1.3.2 Card Guides 1-Slot, incl. mounted ESD-Components

- Bottom: 1 ESD clip and 1 ESD spring
- Top: 1 ESD spring
- Black plastic UL94 V-0



1.3.2 Card Guides 1-Slot, incl. mounted ESD-Components

Card Depth		Description	Part-No. 1 Pair
mm	inch		
80	3.15	1 pair top/bottom	61-949-02

Card Depth		Description	Part-No.
mm	inch		
160	6.30	1 piece bottom	61-950-02
160	6.30	1 piece top	61-950-04

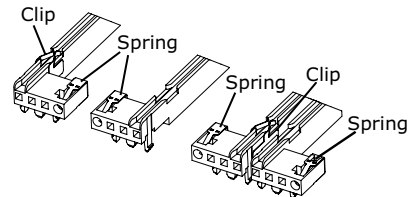
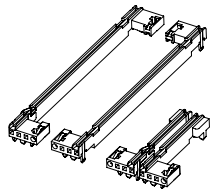

1.3.3. Aluminium Card Guides 1-Slot, 3 Parts



1.3.3.1 Aluminium Card Guides 1-Slot, 3 Parts, 1.6 mm

- Extrusion: Aluminium
- End feet: Plastic UL94 V-0
- For card thickness 1.6 mm / 0.06" and 2.0 mm / 0.08"

Extrusion

Card Depth		Part-No.
mm	inch	
160	6.30	66-452-20
220	8.66	66-452-25
280	11.02	66-452-30
340	13.38	66-452-35

End Feet

Colour	Part-No. 1 Pair
Black	61-955-01
Red	61-955-03

End Feet Offset

Colour	Part-No. 1 Pair
Pearlwhite	61-961-01

1.3.3.2 Aluminium Card Guides 1-Slot, 3 Parts, 2.4 mm

- Extrusion: Aluminium
- End feet: Plastic UL94 V-0
- For card thickness 2.4 mm / 0.094"

Extrusion

Card Depth		Part-No.
mm	inch	
160	6.30	66-453-20
220	8.66	66-453-25
280	11.02	66-453-30
340	13.38	66-453-35

End Feet

Colour	Part-No. 1 Pair
Black	61-956-01



1: Card Guides

1.3.4 ESD Clips

- Connecting printed board with case

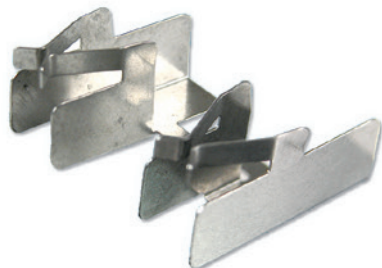

1.3.4 ESD Clips

Description	Part-No.
ESD clip front bottom/rear top	61-419-01
ESD clip front top/rear bottom	61-419-02

1.3.5 ESD Spring

- Connecting ESD pin with case
- Note: Notch inward-looking



1.3.5 ESD Spring

Description	Part-No.
ESD spring	61-420

1.3.6 Coding Pins

- Acc. to IEC 60297-3-103
- Plastic, UL94 V-0
- Can be rotated in 4 positions



1.3.6 Coding Pins

Colour	Part-No.
Grey	81-054-02
Dark red	81-054-06
Black	81-054-04

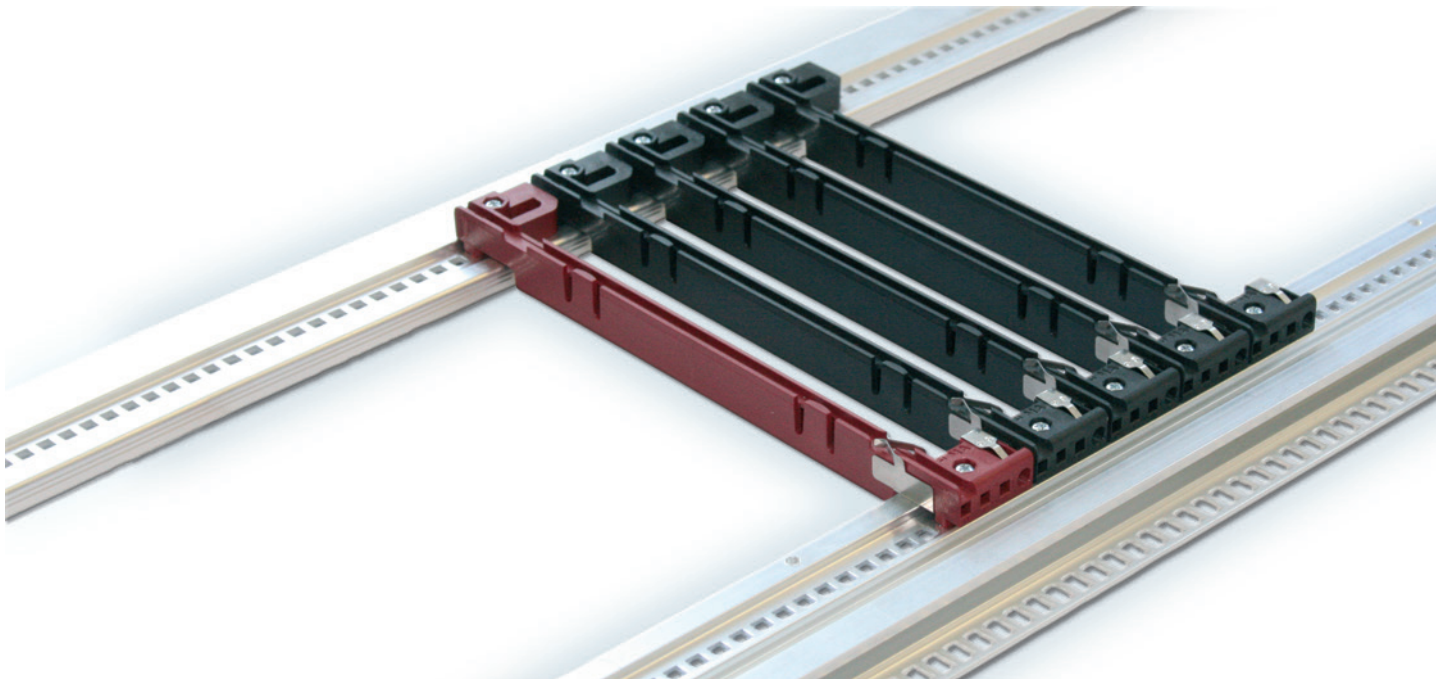

1.4 Rugged Screw-mount Card Guides acc. to IEEE

- Simple assembly comparable to anchoring
- Very high retention force
- Shock and vibration proof
- For positive location of circuit boards and plug-in units
- For card thickness 1.6 mm / 0.06" and 2.0 mm/0.08" with anti-vibration feature
- The card guides are nonflammable, made from a high quality plastic material reinforced with fibreglass (UL94 V-0)
- With ESD provision
- With keying and alignment pin possibilities
- Stainless steel PT-screw, Torque: 0,36 Nm

1.4 Rugged Screw-mount Card Guides acc. to IEEE

- **Scope of delivery:**
 - Card guide, plastic UL94 V-0
 - Security screw see 1.4.1 (at least one must be used)
 - Optional mounting see 1.4.2
 - ESD clip, ESD spring and coding pin see 1.4.3 - 1.4.5



Card Depth		Colour	Part-No. 1 Pair
mm	inch		
80	3.15	black	61-971-01
160	6.30	black	61-970-01
160	6.30	red	61-970-03
160	6.30	pearlwhite / offset	61-972

1.4.1 Standard Mounting

- With Stainless Steel Security Screw (from Top)

1.4.1 Standard Mounting

Description	Part-No.
Cross recessed pan head PT-screw 2.2x12, Inox	5535-12

Note: For highest security 2 screws/card guide, 4 screws/pair are necessary.

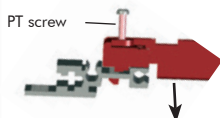

1. Insert Card Guide

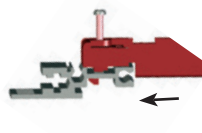

2. Shift Card Guide

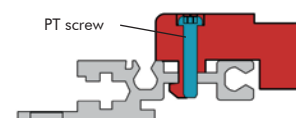

3. Protection by Screwing

1: Card Guides

1.4.2 Optional Mounting

- With M2 screw, washer and nut (from Bottom)



1.4.2 Optional Mounting

Description	Part-No. 1 set (1 each)	Part-No.
Cross recessed pan head screw M2x12, Inox	63-484	5304-13
Hexagonal nut M2 Inox		5620-12
Serrated lock washer		5708-12

Note: For highest security 2 sets/card guide, 4 sets/pair are necessary.

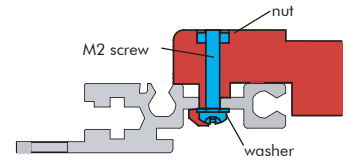
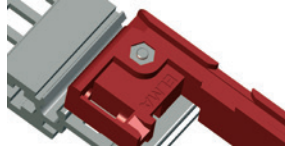

1.4.3 ESD Clips

- Connecting printed board with case



1.4.3 ESD Clips

Description	Part-No.
ESD clip front bottom/rear top	61-419-01
ESD clip front top/rear bottom	61-419-02

1.4.4 ESD Spring

- Connecting ESD pin with case
- Note: Notch inward-looking



1.4.4 ESD Spring

Description	Part-No.
ESD spring	61-420

1.4.5 Coding Pins

- Acc. to IEC60297-3-103
- Plastic, UL94 V-0
- Can be rotated in 4 positions



1.4.5 Coding Pins

Description	Part-No.
Grey	81-054-02
Dark red	81-054-06
Black	81-054-04

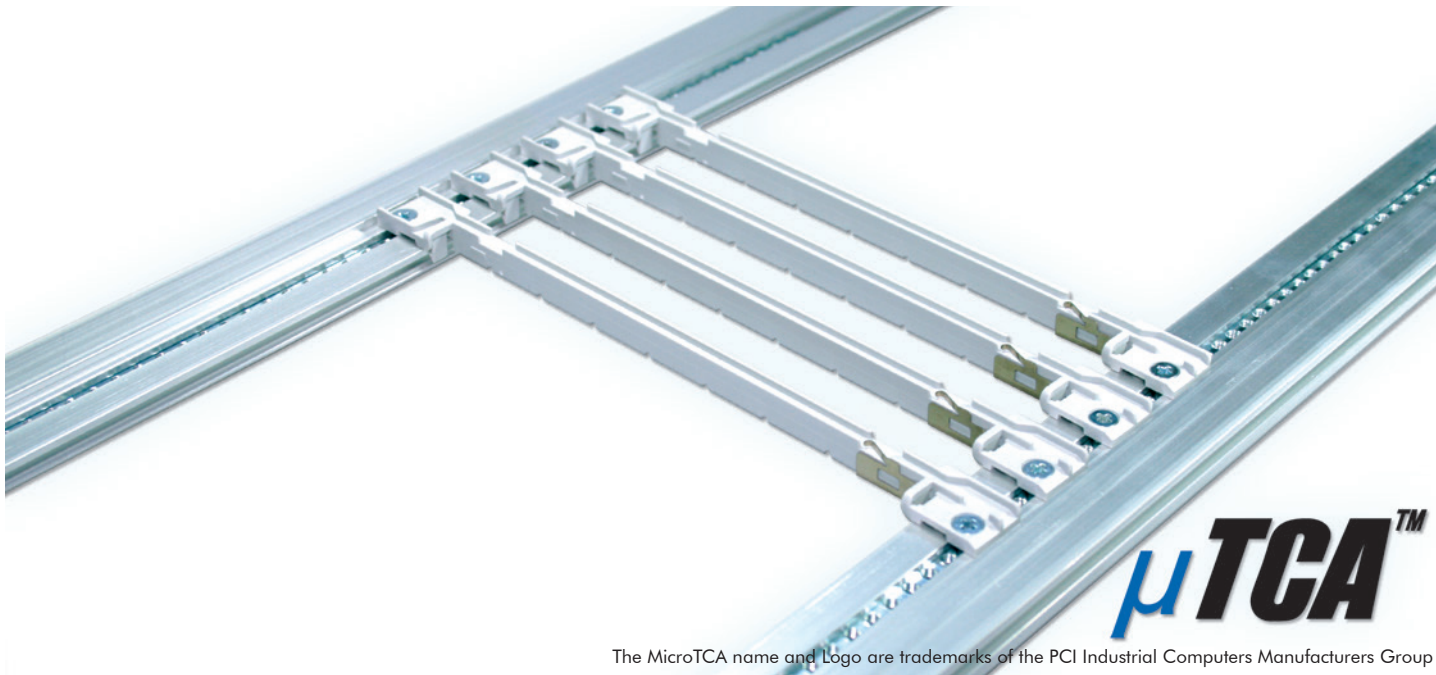

The MicroTCA name and Logo are trademarks of the PCI Industrial Computers Manufacturers Group

uTCA

- The PICMG® Micro Telecommunications Computing Architecture (MicroTCA™) specification defines the requirements for a system that uses PICMG Advanced Mezzanine Cards (AdvancedMCs) directly on a Backplane. This specification, MicroTCA.0, defines the general mechanical, electrical, thermal, and management properties of a MicroTCA Shelf necessary to support AMC.0 compliant Modules.
- MicroTCA has a primary purpose of serving as a platform for telecommunications and enterprise computer network equipment. Its secondary goal is to function as a platform for other demanding marketplaces, such as Customer Premises Equipment (CPE).
- MicroTCA is complementary to the PICMG3.0 Advances Telecommunications Computing Architecture (AdvancedTCA or PICMG3). Where AdvancedTCA is optimised for very high capacity, high performance applications, MicroTCA is designed to address cost sensitive and physically smaller applications with lower capacity, performance, and perhaps less stringent availability requirements. MicroTCA preserves many of the important philosophies of AdvancedTCA, including basic interconnect topologies and management structure

1.5 uTCA Components

- Made to build uTCA card cages
- Conform to the PICMG specification MTCA.0 R1.0
- Prepared to meet EMC requirements

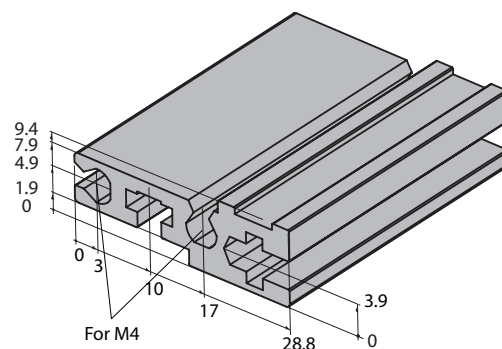

1.5.1 uTCA Extrusion

- Aluminium clear passivated
- Special length or surface treatments on request

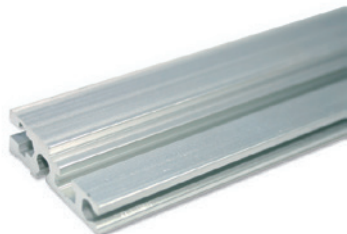

Description	Part-No.
uTCA Extrusion L=443.32 mm	66-242-443
uTCA Extrusion L=428.08 mm	66-242-428

1: Card Guides

1.5.2 uTCA Card Guide

- Fits on extrusion 66-242-X
- Top and bottom use of card guide
- Plastic, grey, UL94 V-0
- ESD clip can be assembled at front and rear



1.5.2 uTCA Card Guide

Description	Part-No.
uTCA Card guide	61-193-00

1.5.3 uTCA ESD Clip

- Fits on uTCA card guide 61-193-00
- Stainless steel



1.5.3 uTCA ESD Clip

Description	Part-No.
uTCA ESD clip	61-194

1.5.4 Tapped Strips M3

- 2 x 6 mm M3
- Fit into uTCA extrusion 66-242-XX
- Steel, galvanised, passivated



1.5.4 Tapped Strips M3

Description	Part-No.
Tapped strips 2 x 6 mm M3, L= 443.02 mm	61-242-443
Tapped strips 2 x 6 mm M3, L= 427.78 mm	61-242-428

1.5.5 Countersunk Screw M3 x 6 mm

- Cross recessed, Philips #1
- Steel, galvanised, passivated



1.5.5 Countersunk Screw M3 x 6 mm

Description	Part-No.
Countersunk screw M3 x 6 mm	5332-06