

EZ-BEAM® M18 Series Sensor

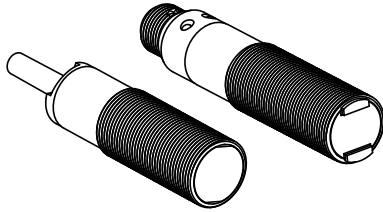

Datasheet

Stainless steel 18 mm barrel-style DC photoelectric sensor



- 18 mm threaded-barrel sensor
- 10 V DC to 30 V DC; choose SPDT (complementary) NPN or PNP outputs (150 mA maximum, each)
- Easy to use; no adjustments are necessary
- Advanced self-diagnostics with separate alarm output (U.S. patent 5087838 (see *Specifications*)); dual LED system indicates sensor performance
- Choice of integral cable or Euro-style quick disconnect connector
- Completely epoxy-encapsulated to provide superior durability, designed to meet rigorous IP69K standards for use in high pressure washdowns
- Brackets available for a wide array of mounting options



WARNING:

- **Do not use this device for personnel protection**
- Using this device for personnel protection could result in serious injury or death.
- This device does not include the self-checking redundant circuitry necessary to allow its use in personnel safety applications. A device failure or malfunction can cause either an energized (on) or de-energized (off) output condition.

Models

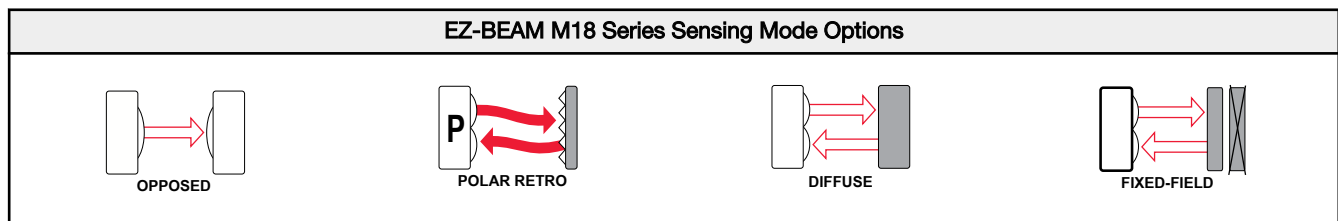

M18 Series Opposed-Mode Emitter (E) and Receiver (R)			
Models (Infrared, 950 nm)	Range	Cable	Output Type
M186E	20 m (66 ft)	2 m (6.5 ft)	-
M186EQ		4-Pin M12/Euro-style QD	
M18SN6R		2 m (6.5 ft)	NPN
M18SN6RQ		4-Pin M12/Euro-style QD	
M18SP6R		2 m (6.5 ft)	PNP
M18SP6RQ		4-Pin M12/Euro-style QD	

Standard 2 m (6.5 ft) cable models are listed. To order the 9 m (30 ft) cable model, add suffix "W/30" (M18SN6R W/30). Models with a QD connector require a mating cable.

M18 Series Retroreflective Mode			
Models	Range	Cable	Output Type
Non-Polarized (Infrared, 950 nm)			
M18SN6L	2 m (79 in)	2 m (6.5 ft)	NPN
M18SN6LQ		4-Pin M12/Euro-style QD	
M18SP6L		2 m (6.5 ft)	PNP
M18SP6LQ		4-Pin M12/Euro-style QD	
Polarized (Visible red, 680 nm)			



M18 Series Retroreflective Mode			
Models	Range	Cable	Output Type
M18SN6LP	2 m (79 in)	2 m (6.5 ft)	NPN
M18SN6LPQ		4-Pin M12/Euro-style QD	
M18SP6LP		2 m (6.5 ft)	PNP
M18SP6LPQ		4-Pin M12/Euro-style QD	

M18 Series Diffuse Mode (Infrared, 880 nm)			
Models	Range	Cable	Output Type
100 mm Range			
M18SN6D	100 mm (4 in)	2 m (6.5 ft)	NPN
M18SN6DQ		4-Pin M12/Euro-style QD	
M18SP6D		2 m (6.5 ft)	PNP
M18SP6DQ		4-Pin M12/Euro-style QD	
300 mm Range			
M18SN6DL	300 mm (12 in)	2 m (6.5 ft)	NPN
M18SN6DLQ		4-Pin M12/Euro-style QD	
M18SP6DL		2 m (6.5 ft)	PNP
M18SP6DLQ		4-Pin M12/Euro-style QD	

M18 Fixed-Field Mode			
Models	Cutoff Point	Cable	Output Type
with 25 mm far limit cutoff			
M18SN6FF25	25 mm (1 in)	2 m (6.5 ft)	NPN
M18SN6FF25Q		4-Pin M12/Euro-style QD	
M18SP6FF25		2 m (6.5 ft)	PNP
M18SP6FF25Q		4-Pin M12/Euro-style QD	
with 50 mm far limit cutoff			
M18SN6FF50	50 mm (2 in)	2 m (6.5 ft)	NPN
M18SN6FF50Q		4-Pin M12/Euro-style QD	
M18SP6FF50		2 m (6.5 ft)	PNP
M18SP6FF50Q		4-Pin M12/Euro-style QD	
with 100 mm far limit cutoff			
M18SN6FF100	100 mm (4 in)	2 m (6.5 ft)	NPN
M18SN6FF100Q		4-Pin M12/Euro-style QD	
M18SP6FF100		2 m (6.5 ft)	PNP
M18SP6FF100Q		4-Pin M12/Euro-style QD	

M18 Fixed-Field Sensor Setup Tips

For highest sensitivity, the sensor-to-object distance should be such that the object will be sensed at or near the point of maximum excess gain.

The background must be beyond the cutoff distance. Following these two guidelines makes it possible to detect objects of low reflectivity, even against close-in reflective backgrounds.

In the drawings and discussion, E, R1, and R2 identify how the sensor's three optical elements (Emitter "E", Near Detector "R1", and Far Detector "R2") line up across the face of the sensor. In [Figure 2](#) on p. 3, [Figure 3](#) on p. 3, and [Figure 4](#) on p. 3, these elements align vertically. In [Figure 5](#) on p. 3, the elements align horizontally.

Note how the position of the tabs on the front of the sensor helps to define the sensing axis of the sensor (Sensing Axis). The sensing axis becomes important in situations like those illustrated in [Figure 4](#) on p. 3 and [Figure 5](#) on p. 3.

As a general rule, the most reliable sensing of an object approaching from the side occurs when the line of approach is parallel to the sensing axis.

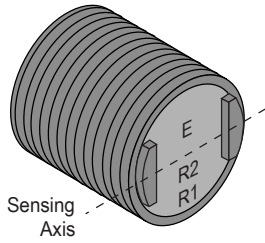

Figure 1. Sensing Axis

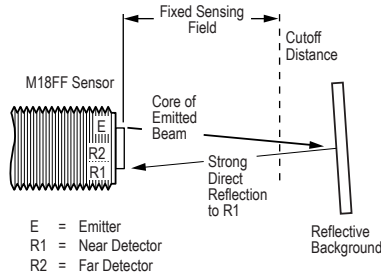

Figure 2. Reflective Background - Problem

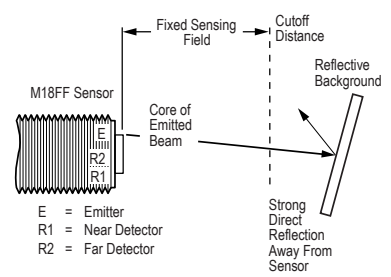

Figure 3. Reflective Background - Solution

Background Reflectivity and Placement. Avoid mirror-like backgrounds that produce specular reflections. False sensor response will occur if a background surface reflects the sensor's light more strongly to the near detector (R1) than to the far detector (R2). The result is a false ON condition (Figure 2 on p. 3). Use of a diffusely-reflective (matte) background will cure this problem. Other possible solutions are to either angle the sensor or angle the background (in any plane) so that the background does not reflect back to the sensor (Figure 3 on p. 3).

An object beyond the cutoff distance, either moving or stationary (and when positioned as shown in Figure 4 on p. 3), can cause unwanted triggering of the sensor because it reflects more light to the near detector than to the far detector. Remedy the problem easily by rotating the sensor 90° (Figure 5 on p. 3) to align the sensing axis horizontally. The object then reflects the R1 and R2 fields equally, resulting in no false triggering. A better solution, if possible, may be to reposition the object or the sensor.

Unwanted triggering of the sensor from an object beyond the cutoff can also be caused by attempting to sense a small object moving perpendicular to the sensor face, or by an object moving through the off-center position shown. Making the object larger, centering the sensor relative to the object, or rotating the sensor to place the sensing axis perpendicular to the longer dimension of the object (Figure 5 on p. 3) will solve the problem.

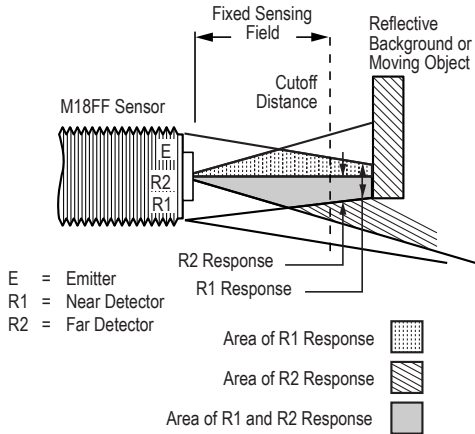

Figure 4. Object Beyond Cutoff - Problem

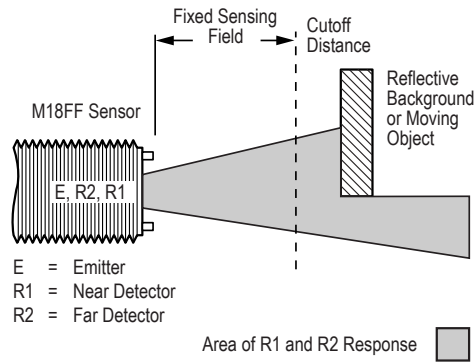

Figure 5. Object Beyond Cutoff - Solution

Wiring Connections

Standard Connection for Attached Cable and Quick Disconnect (QD) Models

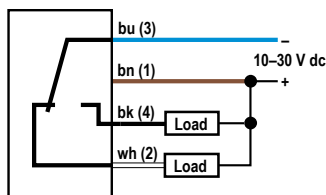

Figure 6. Sensors with NPN (Sinking) Outputs

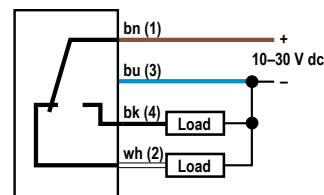

Figure 7. Sensors with PNP (Sourcing) Outputs

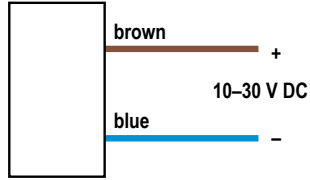

Figure 8. Emitters with Attached Cable

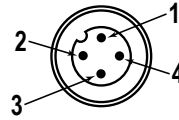

Figure 9. 4-pin M12/Euro-style male QD

1. brown
2. white
3. blue
4. black

Alarm Connection for Attached Cable and Quick Disconnect Models

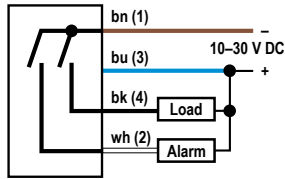

Figure 10. Sensors with NPN (Sinking) Outputs

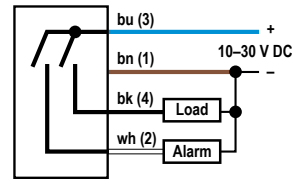

Figure 11. Sensors with PNP (Sourcing) Outputs

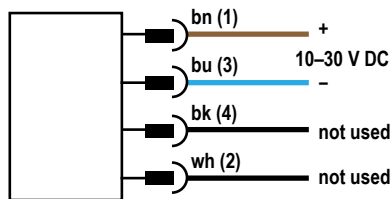

Figure 12. Emitter with Quick Disconnect

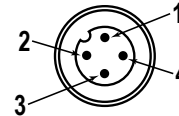

Figure 13. 4-pin M12/Euro-style male QD

1. brown
2. white
3. blue
4. black

Specifications

Supply Voltage

10 to 30 V DC (10% maximum ripple)

Supply Current (Exclusive of Load Current)

Diffuse: 25 mA
 Fixed-field: 35 mA
 Opposed Mode Emitters: 25 mA
 Opposed Mode Receivers: 20 mA
 Retro, Non-polarized: 25 mA
 Retro, Polarized: 30 mA

Supply Protection Circuitry

Protected against reverse polarity and transient voltages

Configuration

SPDT (complementary) solid-state DC switch; choose NPN (current sinking) or PNP (current sourcing) models.

Light operate: Normally open output conducts when the sensor sees its own (or the emitter's) modulated light

Dark operate: Normally closed output conducts when the sensor sees dark; the normally closed output may be wired as a normally open alarm output, depending upon connection to the power supply (U.S. patent 5087838)

Output Rating

150 mA maximum (each) in standard wiring; When wired for alarm output, the total load may not exceed 150 mA
 OFF-State Leakage Current: < 1 microamp at 30 V DC
 ON-State Saturation Voltage: < 1V at 10 mA dc; < 1.5 V at 150 mA DC

Indicators

Two LEDs (green and yellow)
 Green solid: power to sensor is ON
 Green flashing: output is overloaded
 Amber solid: normally open output is conducting
 Amber flashing: excess gain marginal (1-1.5x) in light condition

Construction

Housings: Stainless Steel
 Lenses: Lexan® (opposed models) or acrylic

Connections

2 m (6.5 ft) unterminated 4-wire PVC cable, 9 m (30 ft) unterminated 4-wire PVC cable, or Integral 4-pin M12/Euro-style male quick disconnect

Output Protection Circuitry

Protected against false pulse on power-up and continuous overload or short circuit of outputs

Output Response Time

Opposed mode: 3 milliseconds ON, 1.5 milliseconds OFF
 Polarized Retro, Non-polarized Retro, Fixed-field, and Diffuse: 3 milliseconds ON and OFF
 NOTE: 100 millisecond delay on power-up; outputs do not conduct during this time

Repeatability

Opposed mode: 375 microseconds
 Polarized Retro, Non-Polarized Retro, Fixed-field and Diffuse modes: 750 microseconds
 Repeatability and response are independent of signal strength

Rating

Leakproof design rated NEMA 6P, IP69K* (DIN 40050)

Vibration and Mechanical Shock

All models meet Mil. Std. 202F requirements.
 Method 201A (Vibration; frequency 10 to 60 Hz, max., double amplitude 0.06" acceleration 10G).
 Method 213B conditions H&I (Shock: 75G with unit operating; 100G for non-operation)

* Cabled models meet IP69K if the cable is protected from high-pressure spray

Operating Conditions

-40 °C to +70 °C (-40 °F to +158 °F)
 90% at +50 °C maximum relative humidity (non-condensing)

Dimensions

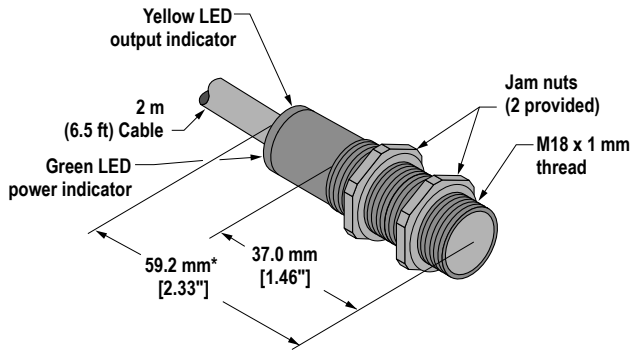

Figure 14. Models with Attached Cable

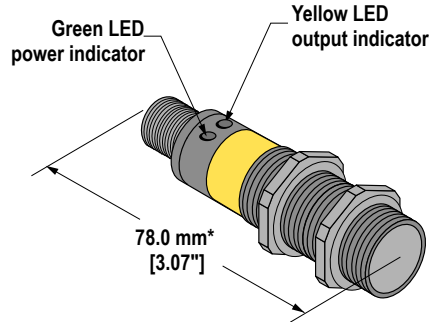

Figure 15. Models with 4-pin M12/Euro-style Quick Disconnect

* Polarized retroreflective and fixed-field cabled models = 65.0 mm (2.56 in)

* Polarized retroreflective and fixed-field QD models = 83.8 mm (3.30 in)

Performance Curves

The excess gain curves above show excess gain vs. sensing distance for M18 Series fixed-field sensors with 25-, 50- and 100-millimeter cutoffs. Maximum excess gain for the 25-mm models occurs at a lens-to-object distance of about 7 mm; for the 50-mm models, at about 10 mm; and for the 100-mm models, at about 20 mm. Sensing at or near these distances will make maximum use of each sensor's available sensing power. Backgrounds and background objects must always be placed beyond the cutoff distance.

These excess gain curves were generated using a white test card of 90% reflectance. Objects with reflectivity of less than 90% reflect less light back to the sensor, and thus require proportionately more excess gain in order to be sensed with the same reliability as more reflective objects. When sensing an object of very low reflectivity, it may be important to sense it at or near the distance of maximum excess gain.

The effects of object reflectivity on cutoff distance, though small, may be important for some applications. Sensing of objects of less than 90% reflectivity causes the cutoff distances to be "pulled" slightly closer to the sensor. For example, an excess gain of 1 for an object that reflects 1/10 as much light as the 90% white card is represented by the heavy horizontal graph line at excess gain = 10. An object of this reflectivity results in far limit cutoffs of approximately 20, 40 and 70 mm (for 25-, 50- and 100-mm cutoff models, respectively).

Objects with reflectivity greater than 90% return more light to the sensor. For this reason, highly reflective backgrounds or background objects such as mirrors, polished metal, and other sources of specular reflections require special consideration. To use a highly reflective background, place it as far beyond the cutoff distance as possible and angle it to direct reflected light away from the sensor.

Opposed-Mode Emitter (E) and Receiver (R)

Excess Gain

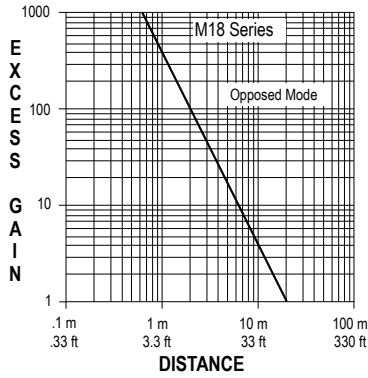

Beam Pattern

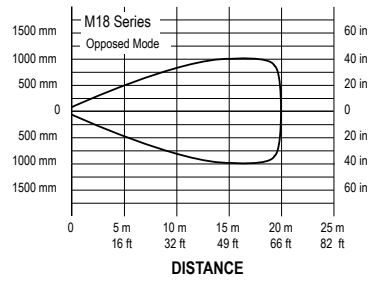

Retroreflective Mode

Excess Gain

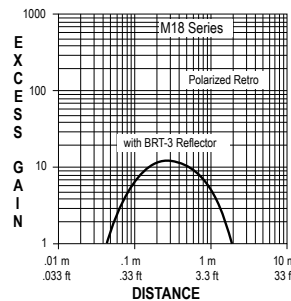
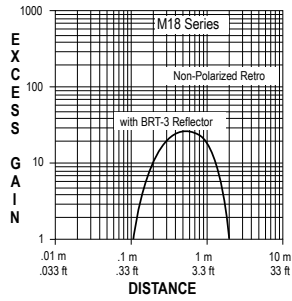

Beam Pattern

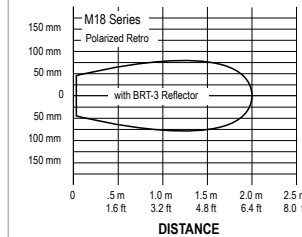
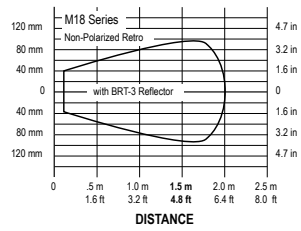

Diffuse Mode

Excess Gain

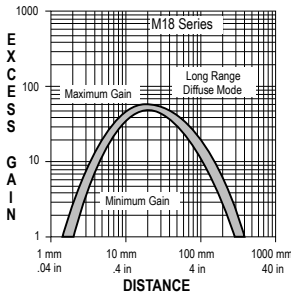
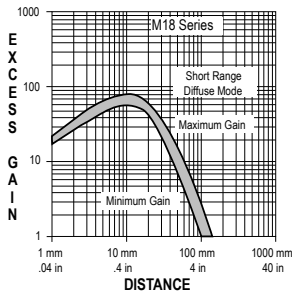

Beam Pattern

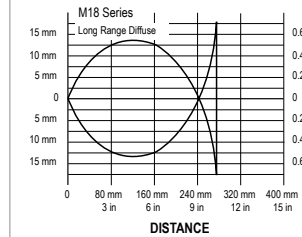
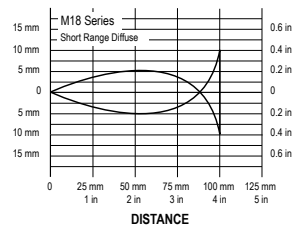

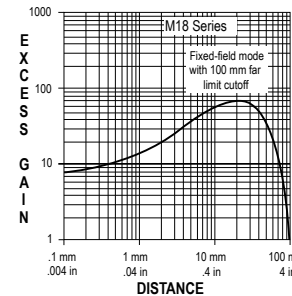
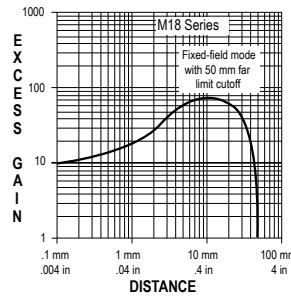
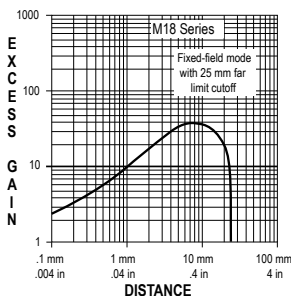

Fixed-Field Mode Excess Gain

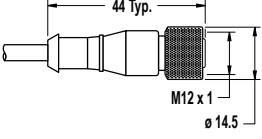

Accessories

Cordsets

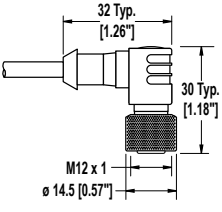
4-Pin Threaded M12/Euro-Style Cordsets—Single Ended				
Model	Length	Style	Dimensions	Pinout (Female)
MQDC-406	2 m (6.56 ft)	Straight		 <p>1 = Brown 2 = White 3 = Blue 4 = Black</p>
MQDC-415	5 m (16.4 ft)			
MQDC-430	9 m (29.5 ft)			
MQDC-450	15 m (49.2 ft)			
MQDC-406RA	2 m (6.56 ft)	Right-Angle		
MQDC-415RA	5 m (16.4 ft)			
MQDC-430RA	9 m (29.5 ft)			
MQDC-450RA	15 m (49.2 ft)			

Mounting Brackets

All measurements are listed in millimeters, unless noted otherwise.

SMB18A

- Right-angle mounting bracket with a curved slot for versatile orientation
- 12-ga. stainless steel
- 18 mm sensor mounting hole
- Clearance for M4 (#8) hardware

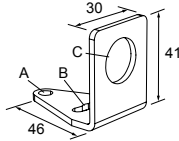

Hole center spacing: A to B = 24.2

Hole size: A = \varnothing 4.6, B = 17.0 x 4.6, C = \varnothing 18.5

SMB18C

- 18 mm split clamp, black thermoplastic polyester
- Stainless steel mounting hardware included

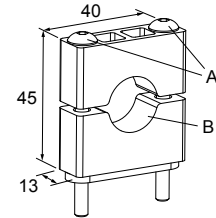

A = \varnothing 3 mm (2)

Hole size: B = \varnothing 18 mm

SMB18SF

- 18 mm swivel bracket with M18 x 1 internal thread
- Black thermoplastic polyester
- Stainless steel swivel locking hardware included

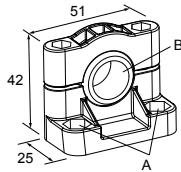

Hole center spacing: A = 36.0

Hole size: A = \varnothing 5.3, B = \varnothing 18.0

SMB18UR

- 2-piece universal swivel bracket
- 300 series stainless steel
- Stainless steel swivel locking hardware included
- Mounting hole for 18 mm sensor

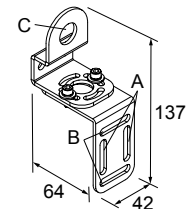

Hole center spacing: A = 25.4, B = 46.7

Hole size: B = 6.9 x 32.0, C = \varnothing 18.3

SMB30SK

- Flat-mount swivel bracket with extended range of motion
- Black reinforced thermoplastic polyester and 316 stainless steel
- Stainless steel swivel locking hardware included

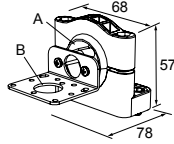

Hole center spacing: A = 50.8

Hole size: A = $\varnothing 7$, B = $\varnothing 18$

Aperture Kits

NOTE: Aperture adds 3/16" to sensor length.

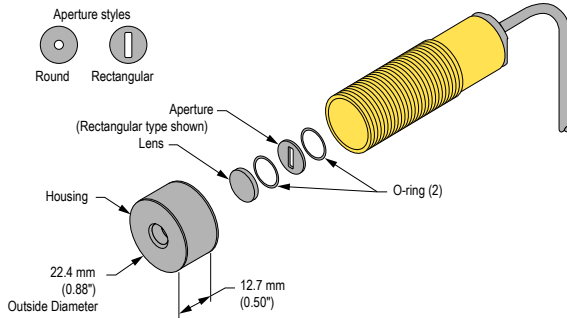
**AP18SC**

Kit includes round apertures of 0.5 mm (0.02 in), 1.0 mm (0.04 in), and 2.5 mm (0.10 in) diameter. Each kit also includes a thread-on aperture housing, a Teflon FEP® lens, and two O-rings.

Used with S18, M18.

**AP18SR**

Kit includes rectangular apertures of 0.5 mm (0.02 in) wide, 1.0 mm (0.04 in) wide, and 2.5 mm (0.10 in) wide. Each kit also includes a thread-on aperture housing, a Teflon FEP® lens, and two O-rings.

Used with S18, M18.



Banner Engineering Corp. Limited Warranty

Banner Engineering Corp. warrants its products to be free from defects in material and workmanship for one year following the date of shipment. Banner Engineering Corp. will repair or replace, free of charge, any product of its manufacture which, at the time it is returned to the factory, is found to have been defective during the warranty period. This warranty does not cover damage or liability for misuse, abuse, or the improper application or installation of the Banner product.

THIS LIMITED WARRANTY IS EXCLUSIVE AND IN LIEU OF ALL OTHER WARRANTIES WHETHER EXPRESS OR IMPLIED (INCLUDING, WITHOUT LIMITATION, ANY WARRANTY OF MERCHANTABILITY OR FITNESS FOR A PARTICULAR PURPOSE), AND WHETHER ARISING UNDER COURSE OF PERFORMANCE, COURSE OF DEALING OR TRADE USAGE.

This Warranty is exclusive and limited to repair or, at the discretion of Banner Engineering Corp., replacement. **IN NO EVENT SHALL BANNER ENGINEERING CORP. BE LIABLE TO BUYER OR ANY OTHER PERSON OR ENTITY FOR ANY EXTRA COSTS, EXPENSES, LOSSES, LOSS OF PROFITS, OR ANY INCIDENTAL, CONSEQUENTIAL OR SPECIAL DAMAGES RESULTING FROM ANY PRODUCT DEFECT OR FROM THE USE OR INABILITY TO USE THE PRODUCT, WHETHER ARISING IN CONTRACT OR WARRANTY, STATUTE, TORT, STRICT LIABILITY, NEGLIGENCE, OR OTHERWISE.**

Banner Engineering Corp. reserves the right to change, modify or improve the design of the product without assuming any obligations or liabilities relating to any product previously manufactured by Banner Engineering Corp. Any misuse, abuse, or improper application or installation of this product or use of the product for personal protection applications when the product is identified as not intended for such purposes will void the product warranty. Any modifications to this product without prior express approval by Banner Engineering Corp will void the product warranties. All specifications published in this document are subject to change; Banner reserves the right to modify product specifications or update documentation at any time. Specifications and product information in English supersedes that which is provided in any other language. For the most recent version of any documentation, refer to: www.bannerengineering.com.

For patent information, see www.bannerengineering.com/patents.

Mouser Electronics

Authorized Distributor

Click to View Pricing, Inventory, Delivery & Lifecycle Information:

[Banner Engineering:](#)

[M186EQ](#) [M18SN6D](#) [M18SN6R](#) [M18SP6DLQ](#) [M186E](#) [M18SN6D W/30](#) [M18SN6DL](#) [M18SN6DLQ](#) [M18SN6DQ](#)
[M18SN6FF100](#) [M18SN6FF100Q](#) [M18SN6FF25Q](#) [M18SN6FF50](#) [M18SN6FF50Q](#) [M18SN6L](#) [M18SN6LP](#)
[M18SN6LP W/30](#) [M18SN6LPQ](#) [M18SN6LQ](#) [M18SN6RQ](#) [M18SP6D](#) [M18SP6DL](#) [M18SP6DQ](#) [M18SP6FF100Q](#)
[M18SP6FF100QPMA](#) [M18SP6FF25](#) [M18SP6FF25Q](#) [M18SP6FF50](#) [M18SP6FF50Q](#) [M18SP6L](#) [M18SP6LP](#)
[M18SP6LPQ](#) [M18SP6LQ](#) [M18SP6R](#) [M18SP6RQ](#) [M18SP6RQP](#) [M186E W/30](#) [M186EQP](#) [M18SN6DL W/30](#)
[M18SN6FF100 W/30](#) [M18SN6FF50 W/30](#) [M18SP6D W/30](#) [M18SP6FF100](#) [M18SP6FF100 W/30](#) [M18SP6FF50 W/30](#)
[M18SP6FF50QPMA](#) [M18SP6L W/30](#) [M18SP6LP W/30](#) [M18SP6R W/30](#)