

INTERCONNECTS

SERIES 830, 831, 832, 833 • 2mm GRID HEADERS AND SOCKETS • SINGLE AND DOUBLE ROW STRIPS

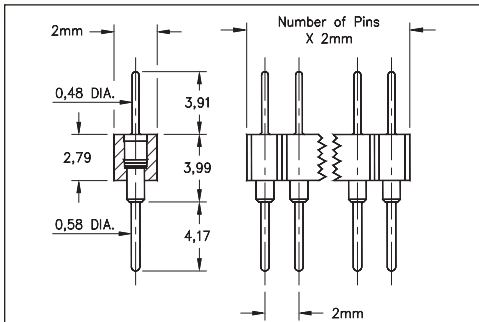

FIG. 1

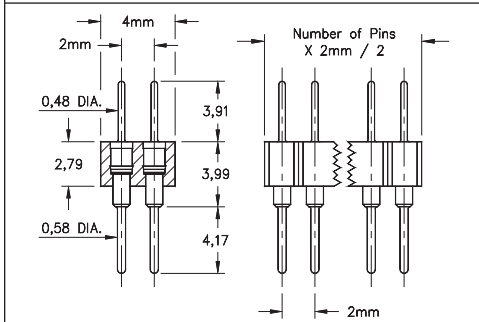

FIG. 2

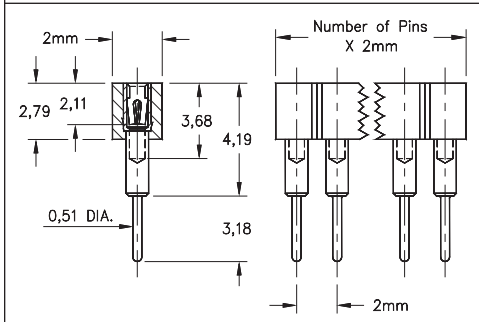

FIG. 3

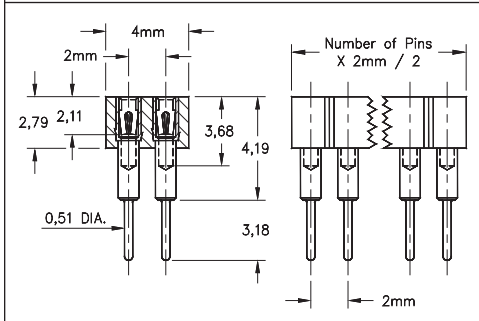
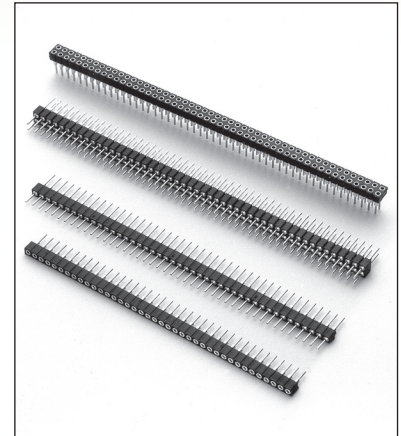

FIG. 4

- Series 830 single & double row interconnects have 2mm pin spacing and permit board stacking as low as 8,18
- Pin headers (830 & 832 series) use MM #5012 pins. See page 208 for details
- Sockets (831 & 833 series) use MM #1802 receptacles and accept pin diameters from 0,38 - 0,64. See page 169 for details
- Contact is rated at 3 amps
- Insulators are high temperature thermoplastic, suitable for all soldering operations



ORDERING INFORMATION









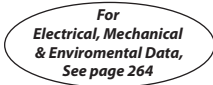



FIG. 1	Series 830...001	Single Row Pin Header		
	830-XX-0	-10-001000	Specify number of pins → 01-50	
FIG. 2	Series 832...001	Double Row Pin Header		
	832-XX-	-10-001000	Specify number of pins → 002-100	
  				
SPECIFY PLATING CODE XX=				
Pin Plating 				
	10 	90	40 	
	0,25µm Au	5,08µm Sn/Pb	5,08µm Sn	

FIG. 3	Series 831...001	Single Row Socket			
	831-XX-0	-10-001000	Specify number of pins → 01-50		
FIG. 4	Series 833...001	Double Row Socket			
	833-XX-	-10-001000	Specify number of pins → 002-100		
  					
SPECIFY PLATING CODE XX=					
Sleeve (Pin) 					
Contact (Clip) 					
	91	93	41 	43 	
	5,08µm Sn/Pb	5,08µm Sn/Pb	5,08µm Sn	5,08µm Sn	
	0,25µm Au	0,76µm Au	0,25µm Au	0,76µm Au	

Mouser Electronics

Authorized Distributor

Click to View Pricing, Inventory, Delivery & Lifecycle Information:

Mill-Max:

[832-90-100-10-001000](#) [830-90-050-10-001000](#) [831-93-050-10-001000](#) [831-93-002-10-001000](#) [832-10-100-10-001000](#) [831-93-032-10-001000](#) [833-93-040-10-001000](#) [833-93-100-10-001000](#) [832-90-040-10-001000](#) [832-40-100-10-001000](#) [830-40-050-10-001000](#) [831-43-004-10-001000](#) [831-91-017-10-001000](#) [831-93-039-10-001000](#) [831-93-009-10-001000](#) [831-41-030-10-001000](#) [831-91-024-10-001000](#) [831-91-041-10-001000](#) [831-93-028-10-001000](#) [831-43-012-10-001000](#) [831-43-048-10-001000](#) [831-93-004-10-001000](#) [831-93-033-10-001000](#) [831-93-037-10-001000](#) [831-91-018-10-001000](#) [831-43-034-10-001000](#) [831-93-041-10-001000](#) [831-91-005-10-001000](#) [831-43-011-10-001000](#) [831-93-034-10-001000](#) [831-41-023-10-001000](#) [831-43-029-10-001000](#) [831-93-016-10-001000](#) [831-91-020-10-001000](#) [831-93-042-10-001000](#) [831-91-015-10-001000](#) [831-41-017-10-001000](#) [831-43-033-10-001000](#) [831-91-047-10-001000](#) [831-41-012-10-001000](#) [831-93-047-10-001000](#) [831-93-001-10-001000](#) [831-41-016-10-001000](#) [831-41-029-10-001000](#) [831-43-047-10-001000](#) [831-93-012-10-001000](#) [831-43-032-10-001000](#) [831-41-031-10-001000](#) [831-43-041-10-001000](#) [831-43-030-10-001000](#) [831-41-050-10-001000](#) [831-41-020-10-001000](#) [831-41-004-10-001000](#) [831-43-024-10-001000](#) [831-91-037-10-001000](#) [831-91-040-10-001000](#) [831-43-026-10-001000](#) [831-91-045-10-001000](#) [831-41-008-10-001000](#) [831-93-017-10-001000](#) [831-91-039-10-001000](#) [831-91-003-10-001000](#) [831-91-025-10-001000](#) [831-43-043-10-001000](#) [831-43-025-10-001000](#) [831-43-018-10-001000](#) [831-41-005-10-001000](#) [831-93-015-10-001000](#) [831-41-009-10-001000](#) [831-91-016-10-001000](#) [831-43-019-10-001000](#) [831-91-004-10-001000](#) [831-91-043-10-001000](#) [831-43-049-10-001000](#) [831-91-030-10-001000](#) [831-93-045-10-001000](#) [831-41-036-10-001000](#) [831-41-042-10-001000](#) [831-43-045-10-001000](#) [831-93-005-10-001000](#) [831-41-018-10-001000](#) [831-43-027-10-001000](#) [831-41-007-10-001000](#) [831-93-049-10-001000](#) [831-41-039-10-001000](#) [831-91-026-10-001000](#) [831-43-046-10-001000](#) [831-93-029-10-001000](#) [831-91-044-10-001000](#) [831-41-038-10-001000](#) [831-43-014-10-001000](#) [831-43-044-10-001000](#) [831-91-023-10-001000](#) [831-91-049-10-001000](#) [831-93-036-10-001000](#) [831-91-038-10-001000](#) [831-43-039-10-001000](#) [831-93-038-10-001000](#) [831-93-024-10-001000](#) [831-93-008-10-001000](#)