

# HITFET - BTS3035EJ

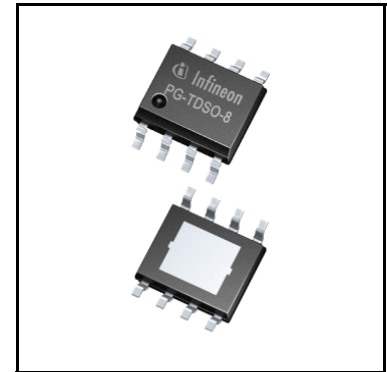
## Smart Low-Side Power Switch



### 1 Overview

#### Basic Features

- Single channel device
- Very low output leakage current in OFF state
- Electrostatic discharge protection (ESD)
- Embedded protection functions (see below)
- ELV compliant package
- Green Product (RoHS compliant)
- AEC Qualified



#### Applications

- Suitable for resistive, inductive and capacitive loads
- Replaces electromechanical relays, fuses and discrete circuits

#### Description

The BTS3035EJ is a 35 mΩ single channel Smart Low-Side Power Switch with in a PG-TDSO8-31 package providing embedded protective functions. The power transistor is built by an N-channel vertical power MOSFET.

The device is monolithically integrated. The BTS3035EJ is automotive qualified and is optimized for 12 V automotive applications.

| Type      | Package     | Marking |
|-----------|-------------|---------|
| BTS3035EJ | PG-TDSO8-31 | S3035EJ |

**Table 1 Product Summary**

|  |               |           |
|--|---------------|-----------|
| Operating voltage range  | $V_{OUT}$     | 0 .. 31 V |
| Maximum load voltage   | $V_{BAT(LD)}$ | 40 V      |
| Maximum input voltage  | $V_{IN}$      | 5.5 V     |
| Maximum On-State resistance at $T_J = 150^{\circ}\text{C}$ , $V_{IN} = 5\text{ V}$ | $R_{DS(ON)}$  | 70 mΩ     |
| Nominal load current   | $I_{L(NOM)}$  | 5 A       |
| Minimum current limitation   | $I_{L(LIM)}$  | 20 A      |
| Maximum OFF state load current at $T_J \leq 85^{\circ}\text{C}$                    | $I_{L(OFF)}$  | 2 μA      |

## Overview

### Diagnostic Functions

- open-drain status output

### Protection Functions

- Over temperature shut-down with automatic-restart
- Active clamp over voltage protection
- Current limitation

### Detailed Description

The device is able to switch all kind of resistive, inductive and capacitive loads, limited by maximum clamping energy and maximum current capabilities.

The BTS3035EJ offers ESD protection on the IN pin which refers to the Source pin (Ground).

The over temperature protection prevents the device from overheating due to overload and/or bad cooling conditions. The temperature information is given by a temperature sensor in the power MOSFET.

The BTS3035EJ has an auto-restart thermal shut-down function. The device will turn on again, if input is still high, after the measured temperature has dropped below the thermal hysteresis.

The over voltage protection can be activated during load dump or inductive turn off conditions. The power MOSFET is limiting the drain-source voltage, if it rises above the  $V_{OUT(CLAMP)}$ .

## Table of Contents

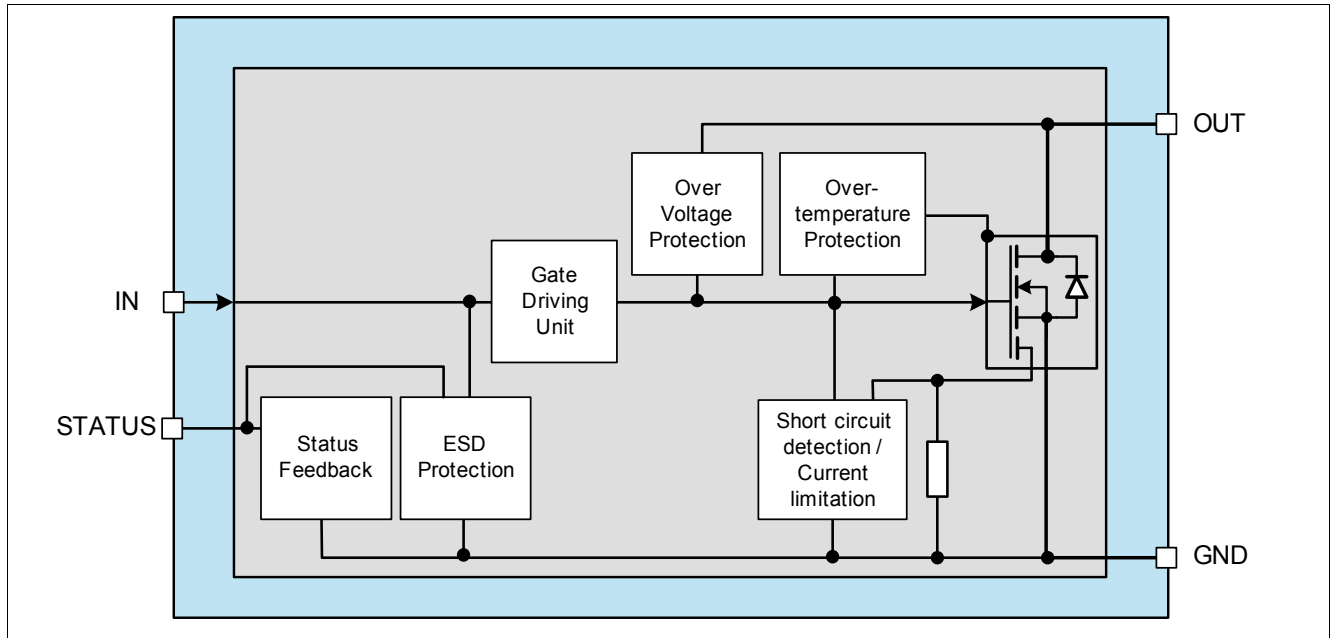
|           |   |           |
|-----------|---|-----------|
| <b>1</b>  | <b>Overview</b> .....                               | <b>1</b>  |
|           | <b>Table of Contents</b> .....                      | <b>3</b>  |
| <b>2</b>  | <b>Block Diagram</b> .....                          | <b>5</b>  |
| <b>3</b>  | <b>Pin Configuration</b> .....                      | <b>6</b>  |
| 3.1       | Pin Assignment BTS3035EJ .....                      | 6         |
| 3.2       | Pin Definitions and Functions .....                 | 6         |
| 3.3       | Voltage and current definition .....                | 7         |
| <b>4</b>  | <b>General Product Characteristics</b> .....        | <b>8</b>  |
| 4.1       | Absolute Maximum Ratings .....                      | 8         |
| 4.2       | Functional Range .....                              | 10        |
| 4.3       | Thermal Resistance .....                            | 11        |
| 4.3.1     | PCB set up .....                                    | 11        |
| 4.3.2     | Transient Thermal Impedance .....                   | 12        |
| <b>5</b>  | <b>Power Stage</b> .....                            | <b>14</b> |
| 5.1       | Output On-state Resistance .....                    | 14        |
| 5.2       | Resistive Load Output Timing .....                  | 14        |
| 5.3       | Inductive Load .....                                | 15        |
| 5.3.1     | Output Clamping .....                               | 15        |
| 5.3.1.1   | Maximum Load Inductance .....                       | 16        |
| 5.4       | Reverse Current capability .....                    | 16        |
| 5.5       | Inverse Current capability .....                    | 17        |
| 5.6       | Characteristics .....                               | 17        |
| <b>6</b>  | <b>Protection Functions</b> .....                   | <b>18</b> |
| 6.1       | Over Voltage Clamping on OUTput .....               | 18        |
| 6.2       | Thermal Protection .....                            | 18        |
| 6.3       | Short Circuit Protection / Current limitation ..... | 18        |
| 6.4       | Characteristics .....                               | 19        |
| <b>7</b>  | <b>Input Stage</b> .....                            | <b>20</b> |
| 7.1       | Input Circuit .....                                 | 20        |
| 7.2       | Characteristics .....                               | 20        |
| <b>8</b>  | <b>Diagnostics</b> .....                            | <b>21</b> |
| <b>9</b>  | <b>Electrical Characteristics</b> .....             | <b>22</b> |
| 9.1       | Power Stage .....                                   | 22        |
| 9.2       | Protection .....                                    | 24        |
| 9.3       | Input Stage .....                                   | 25        |
| 9.4       | Diagnostics (STATUS Pin) .....                      | 25        |
| <b>10</b> | <b>Characterization Results</b> .....               | <b>26</b> |
| 10.1      | Power Stage .....                                   | 26        |
| 10.2      | Protection .....                                    | 37        |
| 10.3      | Input Stage .....                                   | 38        |
| 10.4      | Diagnosis .....                                     | 40        |
| <b>11</b> | <b>Application Information</b> .....                | <b>42</b> |



|           |                               |           |
|-----------|-------------------------------|-----------|
| 11.1      | Application Diagram .....     | 42        |
| <b>12</b> | <b>Package Outlines .....</b> | <b>43</b> |
| <b>13</b> | <b>Revision History .....</b> | <b>44</b> |

**Block Diagram**

**2 Block Diagram**

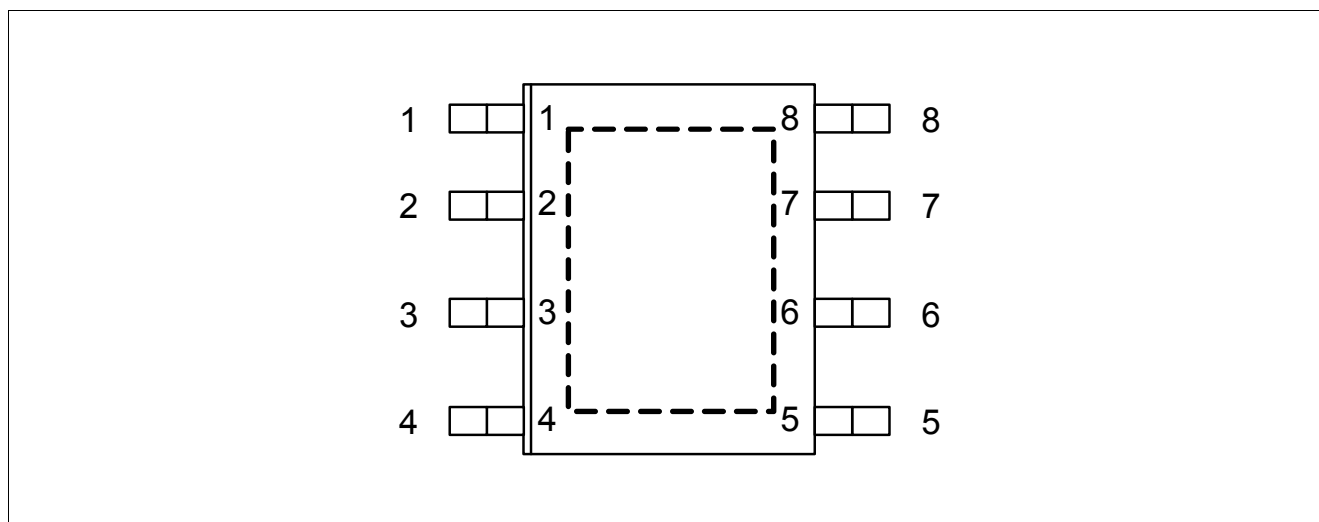


**Figure 1 Block Diagram**

**Pin Configuration**

**3 Pin Configuration**

**3.1 Pin Assignment BTS3035EJ**



**Figure 2 Pin Configuration**

**3.2 Pin Definitions and Functions**

| Pin         | Symbol | Function                                   |
|-------------|--------|--|
| 1           | IN     | Input pin                                  |
| 2           | NC     | not connected                              |
| 3           | STATUS | Open-drain status feedback (low active)    |
| 4           | NC     | not connected                              |
| 5           | NC     | not connected                              |
| 6, 7, 8     | GND    | Ground, Source of power DMOS <sup>1)</sup> |
| cooling tab | OUT    | Drain, Load connection for power DMOS      |

1) All GND pins must be connected together.

Pin Configuration

3.3 Voltage and current definition

Figure 3 shows all external terms used in this datasheet, with associated convention for positive values.

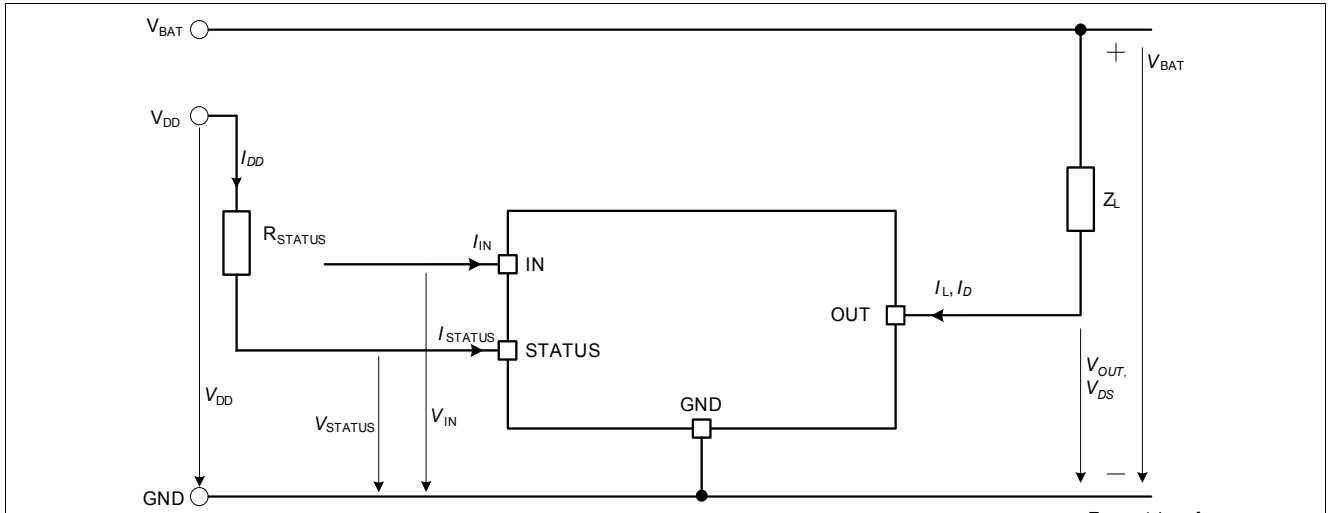


Figure 3 Naming definition of electrical parameters

**General Product Characteristics**

**4 General Product Characteristics**

**4.1 Absolute Maximum Ratings**

**Table 2 Absolute Maximum Ratings<sup>1)</sup>**

$T_j = -40^\circ\text{C}$  to  $+150^\circ\text{C}$ ; all voltages with respect to ground, positive current flowing into pin (unless otherwise specified)

| Parameter   | Symbol                 | Values |      |                     | Unit | Note or Test Condition  | Number   |
|---|------------------------|--------|------|---------------------|------|---|----------|
|   |                        | Min.   | Typ. | Max.                |      |   |          |
| <b>Voltages</b>                                       |                        |        |      |                     |      |   |          |
| Output voltage  | $V_{\text{OUT}}$       | –      | –    | 40                  | V    | internally clamped  | P_4.1.1  |
| Battery voltage for short circuit protection          | $V_{\text{BAT(SC)}}$   | –      | –    | 31                  | V    | $l = 0$ or $5$ m<br>$R_{\text{SC}} = 20 \text{ m}\Omega + R_{\text{Cable}}$<br>$R_{\text{Cable}} = l * 16 \text{ m}\Omega/\text{m}$<br>$L_{\text{SC}} = 5 \text{ }\mu\text{H} + L_{\text{Cable}}$<br>$L_{\text{Cable}} = l * 1 \text{ }\mu\text{H}/\text{m}$<br>$V_{\text{IN}} = 5 \text{ V}$ | P_4.1.2  |
| Battery voltage for load dump protection              | $V_{\text{BAT(LD)}}$   | –      | –    | 40                  | V    | <sup>2)</sup><br>$R_I = 2 \text{ }\Omega$<br>$R_L = 4.5 \text{ }\Omega$<br>$t_D = 400 \text{ ms}$<br>suppressed pulse   | P_4.1.4  |
| <b>Input Pin</b>                                      |                        |        |      |                     |      |   |          |
| Input Voltage   | $V_{\text{IN}}$        | -0.3   | –    | 5.5                 | V    | –   | P_4.1.7  |
| Input current in inverse condition on OUT to GND)     | $I_{\text{IN}}$        | –      | –    | 2                   | mA   | <sup>3)</sup><br>$V_{\text{OUT}} < -0.3 \text{ V}$  | P_4.1.10 |
| <b>Status Pin</b>                                     |                        |        |      |                     |      |   |          |
| Status Voltage  | $V_{\text{STATUS}}$    | -0.3   | –    | 5.5                 | V    | –   | P_4.1.11 |
| Status current  | $I_{\text{STATUS}}$    | –      | –    | 5                   | mA   | $-0.3 \text{ V} < V_{\text{STATUS}} < 5.5 \text{ V}$  | P_4.1.12 |
| Status current in inverse current condition on STATUS | $I_{\text{STATUS\_L}}$ | -1     | –    | –                   | mA   | $V_{\text{STATUS}} < -0.3 \text{ V}$  | P_4.1.13 |
| <b>Power Stage</b>                                    |                        |        |      |                     |      |   |          |
| Load current  | $ I_L $                | –      | –    | $I_{\text{L(LIM)}}$ | A    | –   | P_4.1.14 |
| <b>Energies</b>                                       |                        |        |      |                     |      |   |          |
| Unclamped single inductive energy single pulse        | $E_{\text{AS}}$        | –      | –    | 105                 | mJ   | $I_{\text{L(0)}} = I_{\text{L(NOM)}}$<br>$V_{\text{BAT}} = 13.5 \text{ V}$<br>$T_{\text{J(0)}} = 150^\circ\text{C}$   | P_4.1.18 |
| Unclamped repetitive inductive energy pulse with 10k  | $E_{\text{AR(10k)}}$   | –      | –    | 105                 | mJ   | $I_{\text{L(0)}} = I_{\text{L(NOM)}}$<br>$V_{\text{BAT}} = 13.5 \text{ V}$<br>$T_{\text{J(0)}} = 105^\circ\text{C}$   | P_4.1.30 |



**General Product Characteristics**

**Table 2 Absolute Maximum Ratings<sup>1)</sup> (cont'd)**

$T_j = -40^{\circ}\text{C}$  to  $+150^{\circ}\text{C}$ ; all voltages with respect to ground, positive current flowing into pin (unless otherwise specified)

| Parameter  | Symbol         | Values |      |      | Unit | Note or Test Condition   | Number   |
|--|----------------|--------|------|------|------|--|----------|
|  |                | Min.   | Typ. | Max. |      |  |          |
| Unclamped repetitive inductive energy pulse with 100k cycles | $E_{AR(100k)}$ | –      | –    | 84   | mJ   | $I_{L(0)} = I_{L(NOM)}$<br>$V_{BAT} = 13.5\text{ V}$<br>$T_{J(0)} = 105^{\circ}\text{C}$ | P_4.1.36 |
| Unclamped repetitive inductive energy pulse with 1M          | $E_{AR(1M)}$   | –      | –    | 67   | mJ   | $I_{L(0)} = I_{L(NOM)}$<br>$V_{BAT} = 13.5\text{ V}$<br>$T_{J(0)} = 105^{\circ}\text{C}$ | P_4.1.42 |

**Temperatures**

|                       |           |     |   |      |                    |   |          |
|-----------------------|-----------|-----|---|------|--------------------|---|----------|
| Operating temperature | $T_J$     | -40 | – | +150 | $^{\circ}\text{C}$ | – | P_4.1.52 |
| Storage temperature   | $T_{STG}$ | -55 | – | +150 | $^{\circ}\text{C}$ | – | P_4.1.53 |

**ESD Susceptibility**

|                                    |           |     |   |    |    |                   |          |
|------------------------------------|-----------|-----|---|----|----|-------------------|----------|
| ESD susceptibility (all pins)      | $V_{ESD}$ | -3  | – | 3  | kV | HBM <sup>4)</sup> | P_4.1.54 |
| ESD susceptibility OUT-pin to GND  | $V_{ESD}$ | -10 | – | 10 | kV | HBM <sup>5)</sup> | P_4.1.55 |
| ESD susceptibility                 | $V_{ESD}$ | -1  | – | 1  | kV | CDM <sup>6)</sup> | P_4.1.56 |
| ESD susceptibility non-corner pins | $V_{ESD}$ | -1  | – | 1  | kV | CDM <sup>7)</sup> | P_4.1.57 |

- 1) Not subject to production test, specified by design.
- 2)  $V_{BAT(LD)}$  is setup without the DUT connected to the generator per ISO 7637-1;  
 $R_i$  is the internal resistance of the load dump test pulse generator;  
 $t_D$  is the pulse duration time for load dump pulse (pulse 5) according ISO 7637-1, -2.
- 3) Maximum allowed value. Consider also inverse input current in inverse condition  $I_{IN(-VOUT)}$  in Chapter 9
- 4) ESD susceptibility, HBM according to ANSI/ESDA/JEDEC JS001 (1.5 kV, 100 pF)
- 5) ESD susceptibility, HBM according to ANSI/ESDA/JEDEC JS001 (1.5 kV, 100 pF)
- 6) ESD susceptibility, Charged Device Model “CDM” ESDA STM5.3.1 or ANSI/ESD S.5.3.1
- 7) ESD susceptibility, Charged Device Model “CDM” ESDA STM5.3.1 or ANSI/ESD S.5.3.1

**Notes**

1. Stresses above the ones listed here may cause permanent damage to the device. Exposure to absolute maximum rating conditions for extended periods may affect device reliability.
2. Integrated protection functions are designed to prevent IC destruction under fault conditions described in the data sheet. Fault conditions are considered as “outside” normal operating range. Protection functions are not designed for continuous repetitive operation.

**General Product Characteristics**

**4.2 Functional Range**

**Table 3 Functional Range** <sup>1)</sup>

Please refer to **“Electrical Characteristics” on Page 22** for test conditions

| Parameter                                    | Symbol         | Values |      |      | Unit | Note or Test Condition        | Number  |
|--|----------------|--------|------|------|------|-------------------------------|---------|
|  |                | Min.   | Typ. | Max. |      |                               |         |
| Battery Voltage Range for Nominal Operation  | $V_{BAT(NOR)}$ | 6.0    | 13.5 | 18.0 | V    | –                             | P_4.2.1 |
| Extended Battery Voltage Range for Operation | $V_{BAT(EXT)}$ | 0      | –    | 31   | V    | parameter deviations possible | P_4.2.2 |
| Input Voltage Range for Nominal Operation    | $V_{IN(NOR)}$  | 3.0    | –    | 5.5  | V    | –                             | P_4.2.3 |
| Junction Temperature                         | $T_J$          | -40    | –    | 150  | °C   | –                             | P_4.2.5 |

1) Not subject to production test, specified by design

*Note: Within the functional range the IC operates as described in the circuit description. The electrical characteristics are specified within the conditions given in the related electrical characteristics table.*

**General Product Characteristics**

**4.3 Thermal Resistance**

Note: This thermal data was generated in accordance with JEDEC JESD51 standards.  
 For more information, go to [www.jedec.org](http://www.jedec.org).

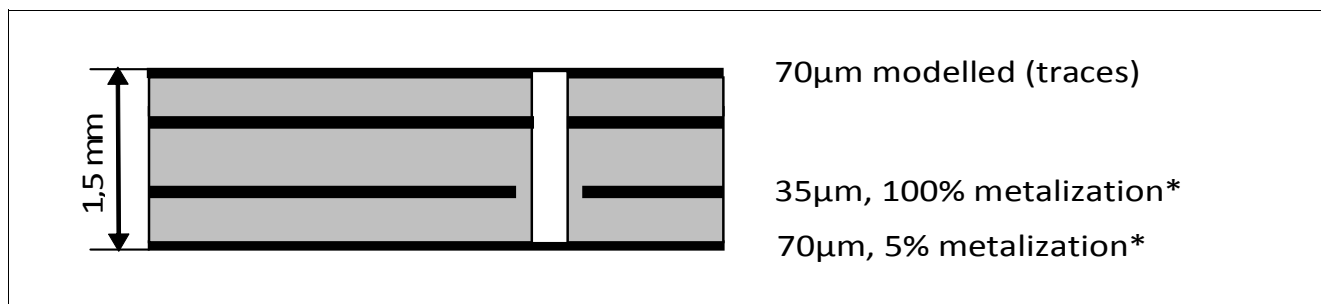
**Table 4 Thermal Resistance PG-TDS08-31**

| Parameter   | Symbol           | Values |      |      | Unit | Note or Test Condition | Number   |
|---|------------------|--------|------|------|------|------------------------|----------|
|   |                  | Min.   | Typ. | Max. |      |                        |          |
| Junction to Soldering Point                       | $R_{thJSP}$      | –      | 1.9  | –    | K/W  | 1) 2)                  | P_4.3.3  |
| Junction to Ambient (2s2p)                        | $R_{thJA(2s2p)}$ | –      | 34   | –    | K/W  | 1) 3)                  | P_4.3.9  |
| Junction to Ambient (1s0p+600 mm <sup>2</sup> Cu) | $R_{thJA(1s0p)}$ | –      | 45   | –    | K/W  | 1) 4)                  | P_4.3.15 |
| Junction to Ambient (1s0p+300 mm <sup>2</sup> Cu) | $R_{thJA(1s0p)}$ | –      | 55   | –    | K/W  | 1) 5)                  | P_4.3.21 |

- 1) Not subject to production test, specified by design
- 2) Specified  $R_{thJSP}$  value is simulated at natural convection on a cold plate setup (all pins are fixed to ambient temperature).  
 $T_A = 85^\circ\text{C}$ . Device is loaded with 1 W power.
- 3) Specified  $R_{thJA}$  value is according to Jedec JESD51-2,-5,-7 at natural convection on FR4 2s2p board; The product (Chip + Package) was simulated on a 76.2 x 114.3 x 1.5 mm board with 2 inner copper layers (2 x 70  $\mu\text{m}$  Cu, 2 x 35  $\mu\text{m}$  Cu). Where applicable a thermal via array under the exposed pad contacted the first inner copper layer.  
 $T_A = 85^\circ\text{C}$ , Device is loaded with 1 W power.
- 4) Specified  $R_{thJA}$  value is according to Jedec JESD51-2,-5,-7 at natural convection on FR4 1s0p board; The product (Chip + Package) was simulated on a 76.2 x 114.3 x 1.5 mm board with additional heatspreading copper area of 600 mm<sup>2</sup> and 70  $\mu\text{m}$  thickness.  $T_A = 85^\circ\text{C}$ , Device is loaded with 1 W power.
- 5) Specified  $R_{thJA}$  value is according to Jedec JESD51-2,-5,-7 at natural convection on FR4 1s0p board; The product (Chip + Package) was simulated on a 76.2 x 114.3 x 1.5 mm board with additional heatspreading copper area of 300 mm<sup>2</sup> and 70  $\mu\text{m}$  thickness.  $T_A = 85^\circ\text{C}$ , Device is loaded with 1 W power.

**4.3.1 PCB set up**

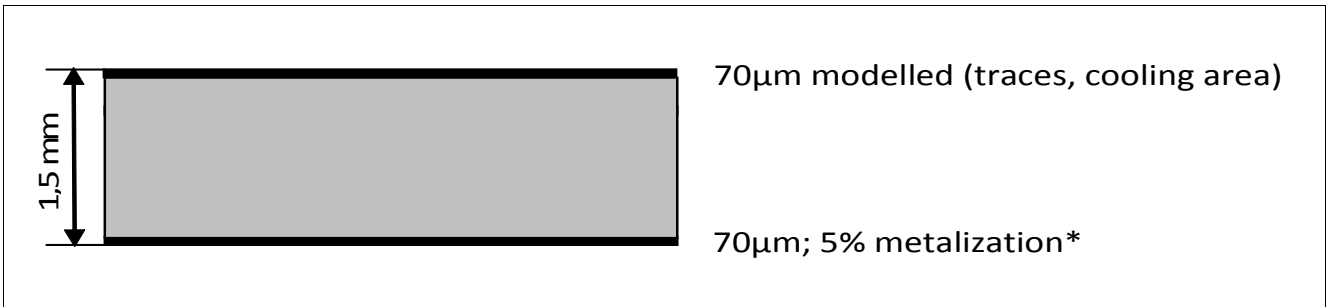
The following PCB set up was implemented to determine the transient thermal impedance<sup>1)</sup>



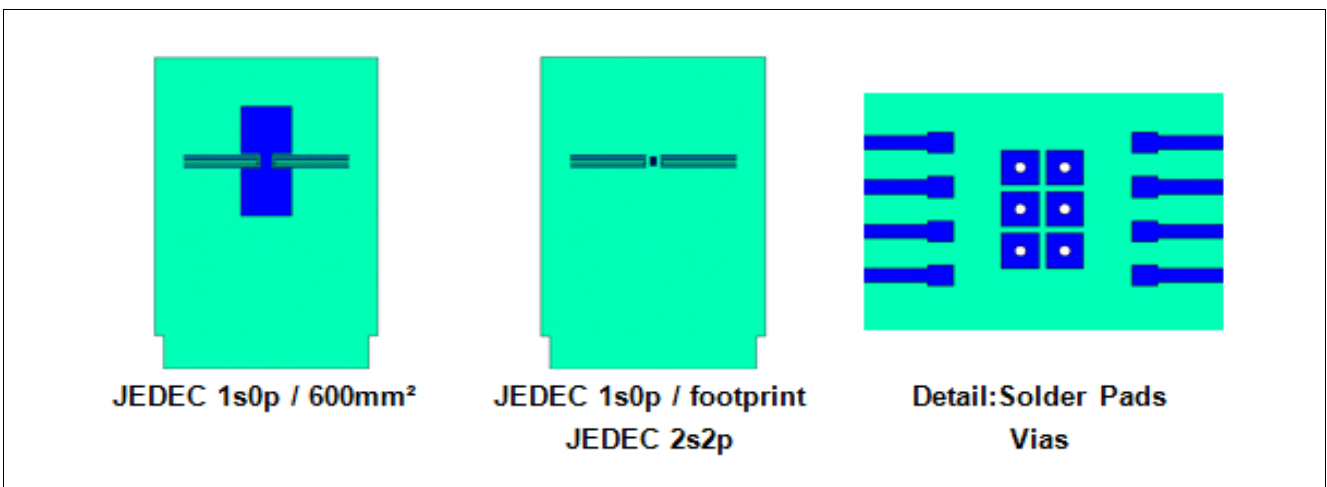
**Figure 4 Cross section JEDEC2s2p**

1) (\*) means percentual Cu metalization on each layer

**General Product Characteristics**



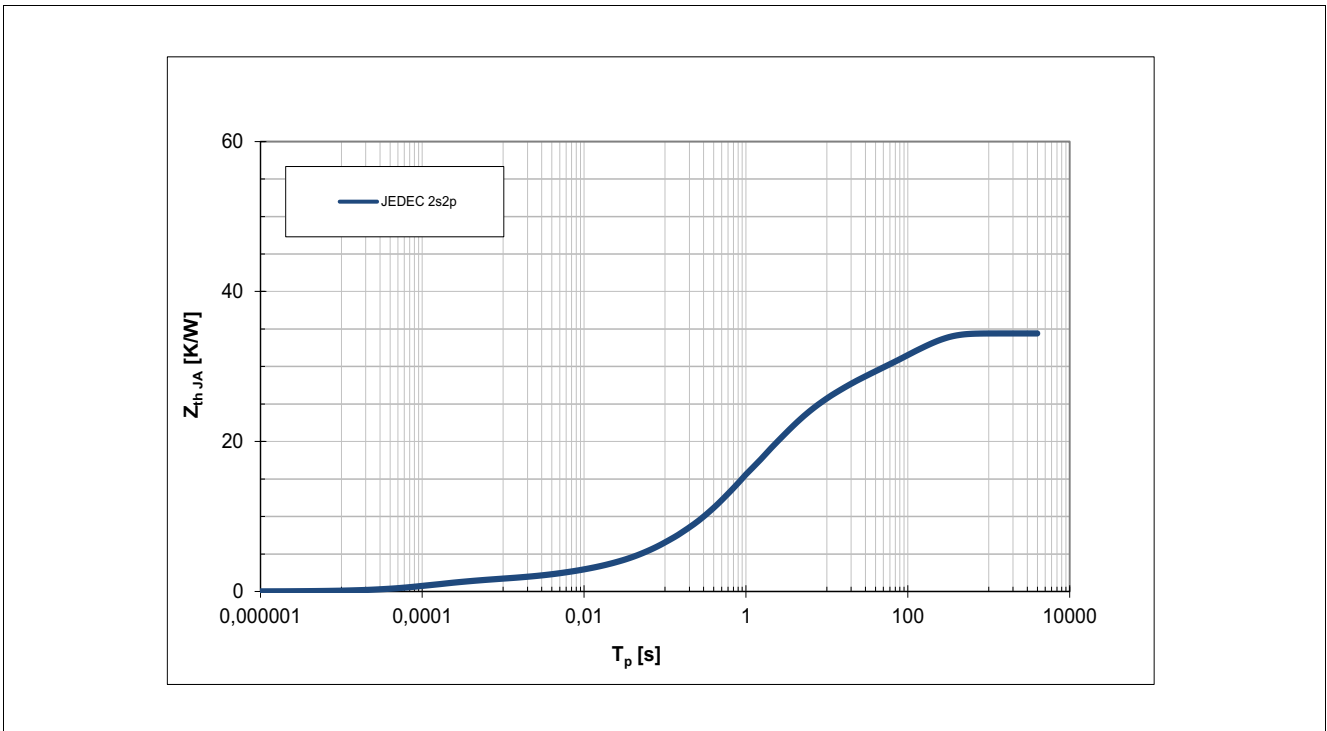
**Figure 5** Cross section JEDEC1s0p



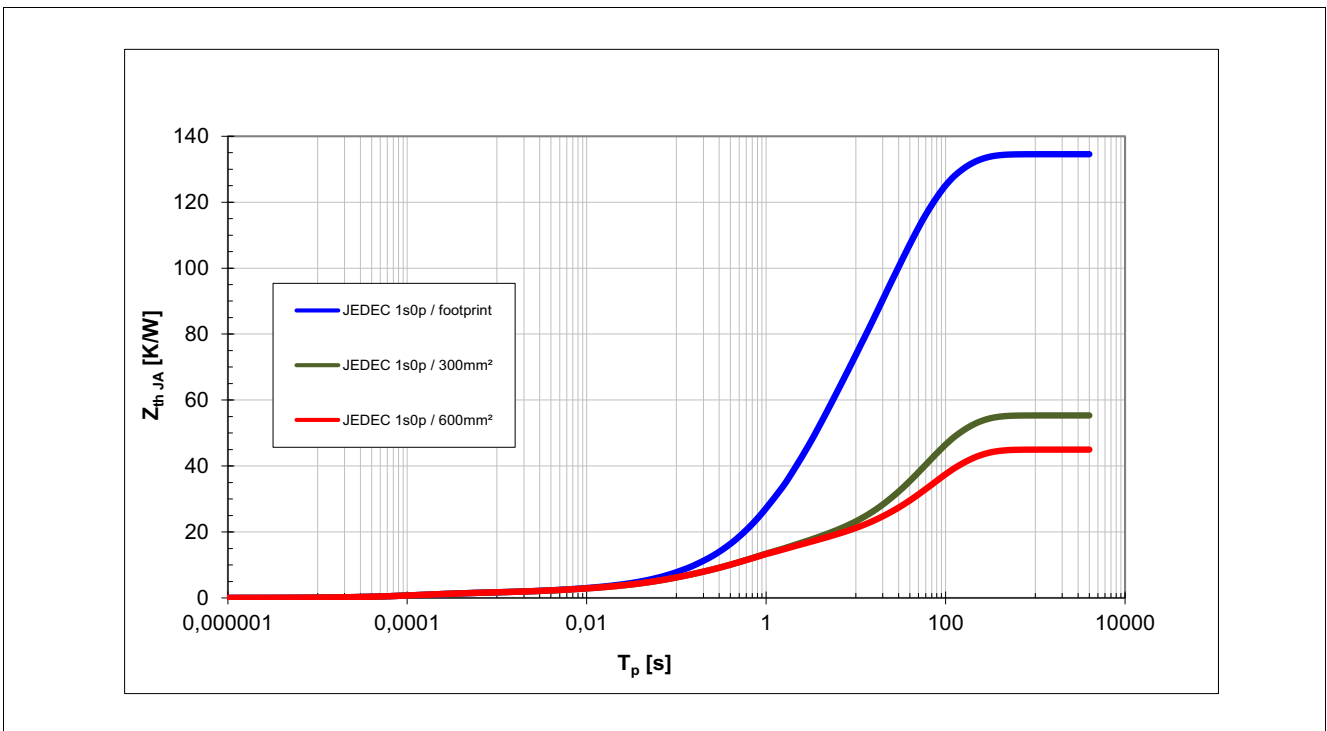
**Figure 6** PCB layout

**4.3.2 Transient Thermal Impedance**

General Product Characteristics



**Figure 7** Typical transient thermal impedance  $Z_{th,JA} = f(t_p)$ ,  $T_A = 85^\circ\text{C}$   
Value is according to Jedec JESD51-2,-7 at natural convection on FR4 2s2p board; The product (Chip + Package) was simulated on a  $76.2 \times 114.3 \times 1.5 \text{ mm}^3$  board with 2 inner copper layers (2 x  $70 \mu\text{m}$  Cu, 2 x  $35 \mu\text{m}$  Cu). Device is dissipating 1 W power.



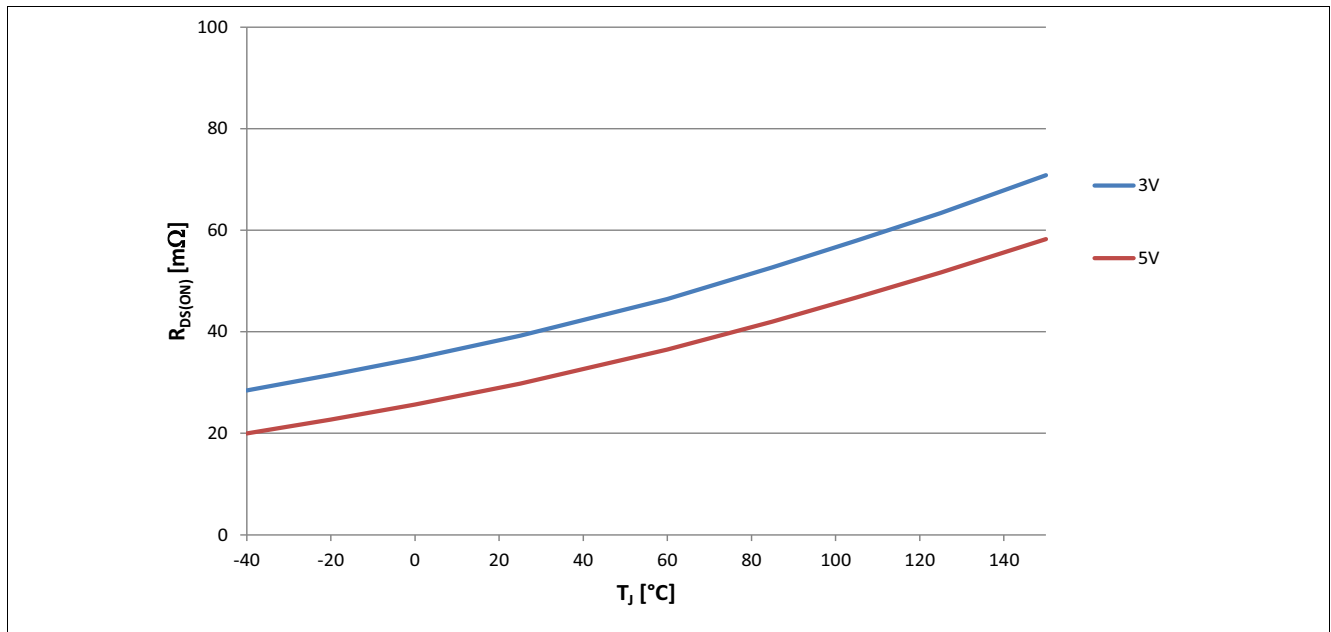
**Figure 8** Typical transient thermal impedance  $Z_{th,JA} = f(t_p)$ ,  $T_a = 85^\circ\text{C}$   
Value is according to Jedec JESD51-3 at natural convection on FR4 1s0p board. Device is dissipating 1 W power.

Power Stage

## 5 Power Stage

### 5.1 Output On-state Resistance

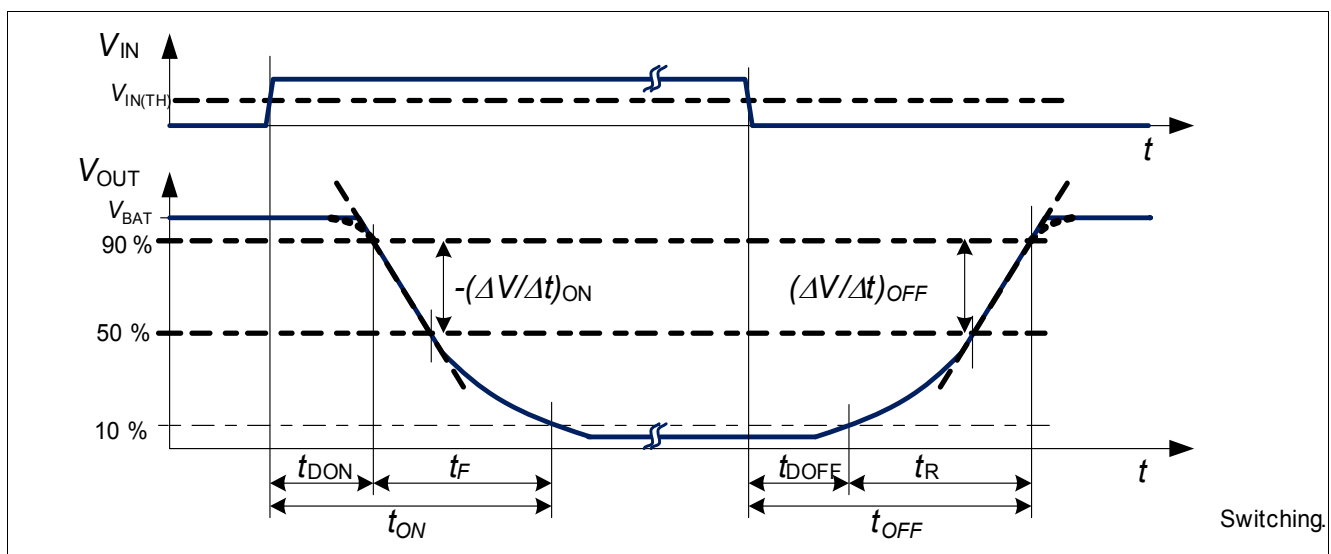
The on-state resistance depends on the junction temperature  $T_J$ . The Figure below show this dependencies in terms of temperature and voltage for the typical on-state resistance  $R_{DS(ON)}$ . The behavior in reverse polarity is described in “Reverse Current capability” on Page 16



**Figure 9** Typical On-State Resistance,  
 $R_{DS(ON)} = f(T_J)$ ,  $V_{IN} = 3V$ ;  $V_{IN} = 5V$

### 5.2 Resistive Load Output Timing

**Figure 10** shows the typical timing when switching a resistive load.



**Figure 10** Definition of Power Output Timing for Resistive Load

Power Stage

5.3 Inductive Load

5.3.1 Output Clamping

When switching off inductive loads with low side switches, the Drain-Source voltage  $V_{OUT}$  rises above battery potential, because the inductance intends to continue driving the current. To prevent unwanted high voltages the device has a voltage clamping mechanism to keep the voltage at  $V_{OUT(CLAMP)}$ . During this clamping operation mode the device heats up as it dissipates the energy from the inductance. Therefore the maximum allowed load inductance is limited. See [Figure 11](#) and [Figure 12](#) for more details.

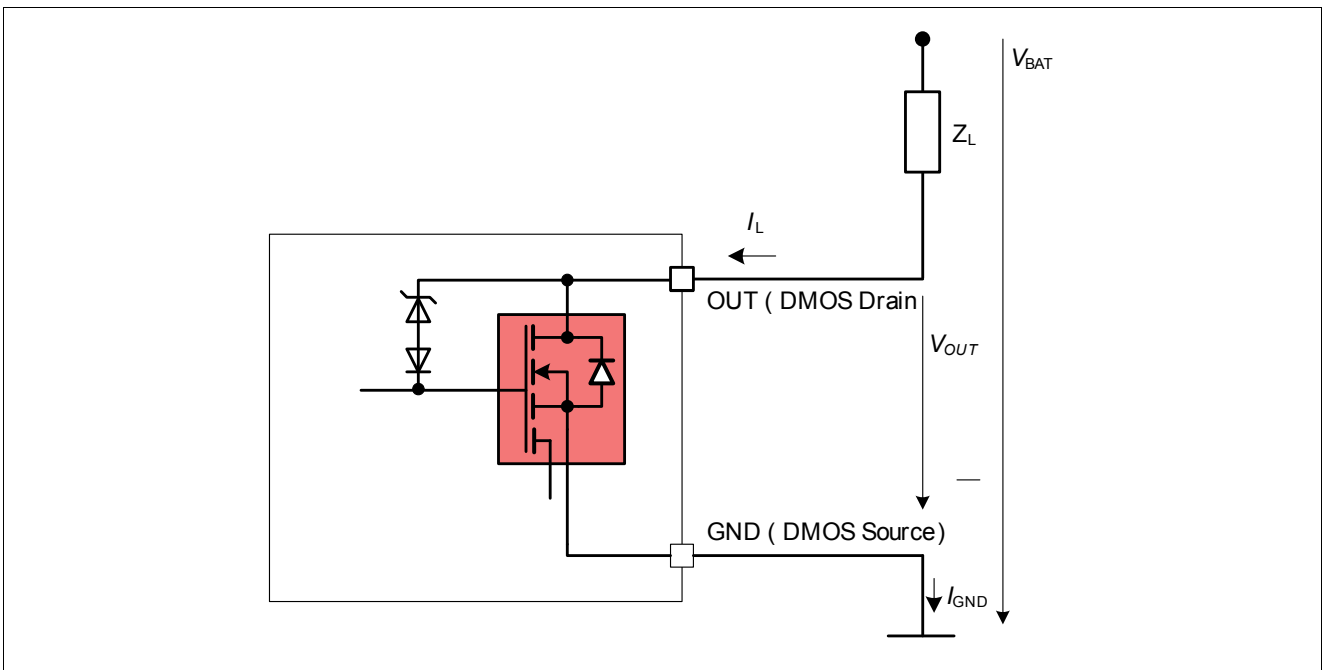


Figure 11 Output Clamp Circuitry

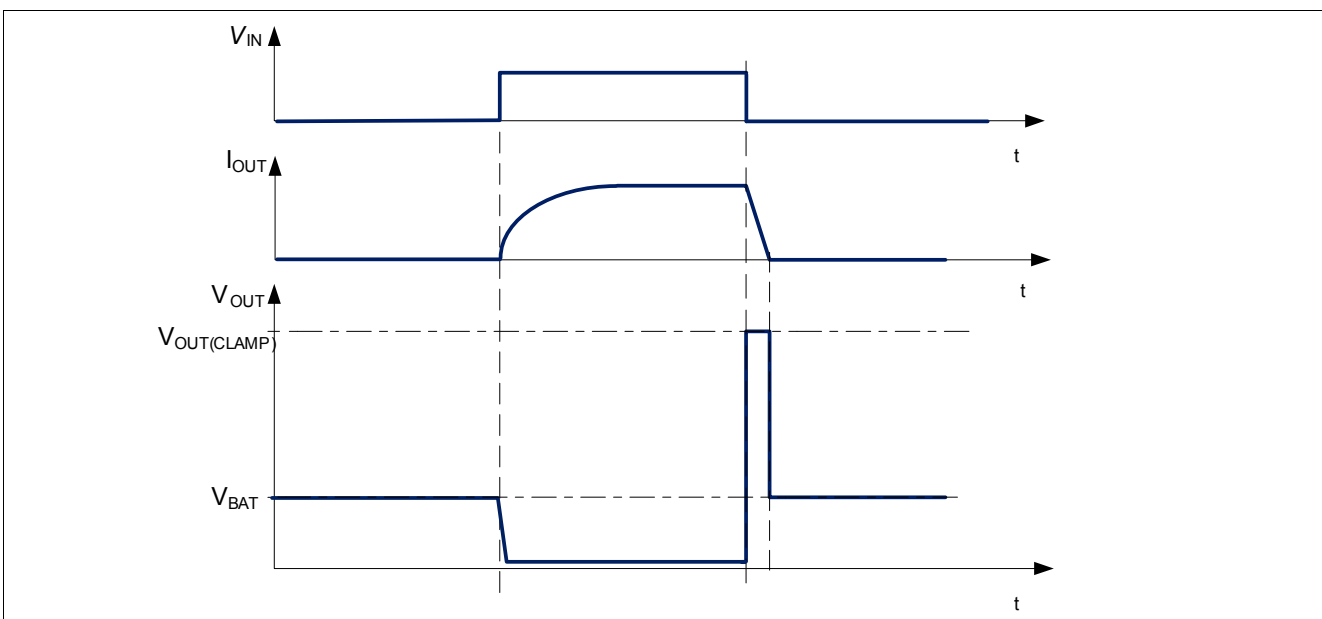


Figure 12 Switching an Inductive Load

**Power Stage**

**5.3.1.1 Maximum Load Inductance**

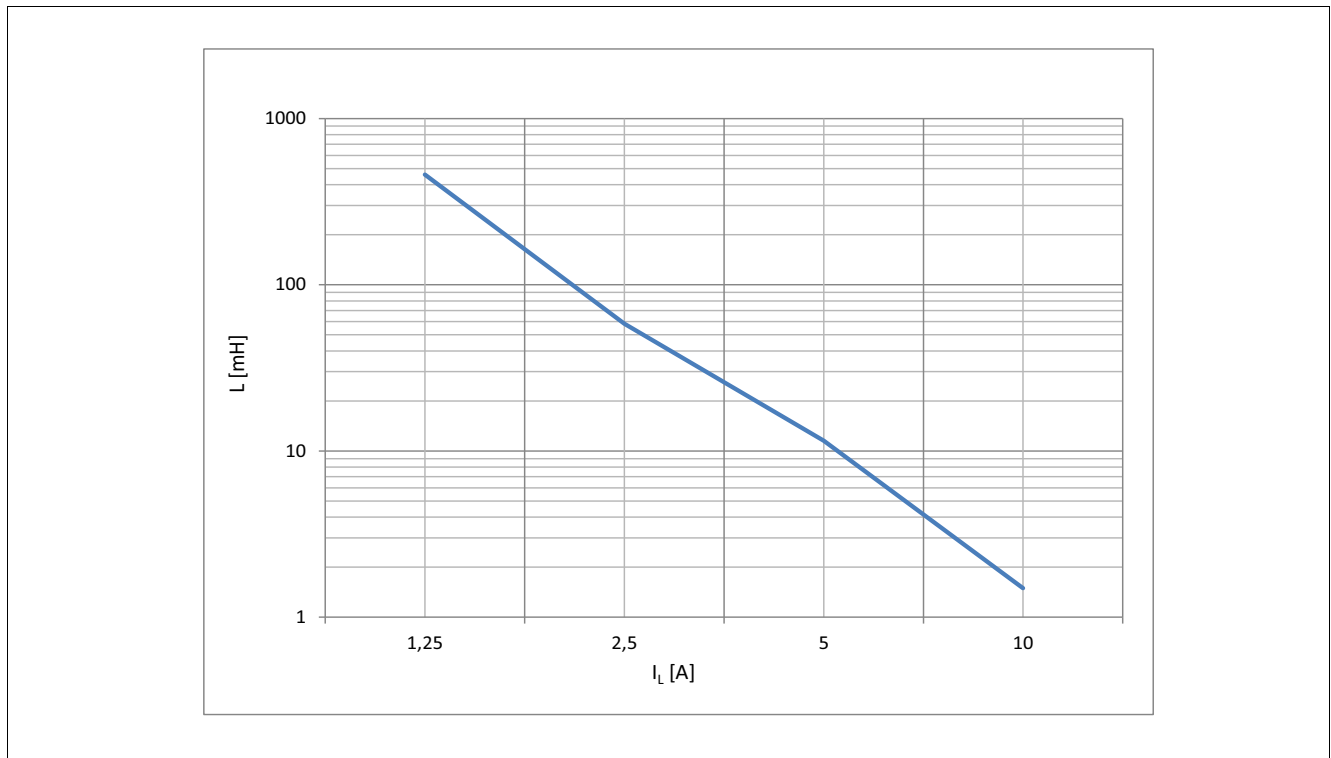
While demagnetization of inductive loads, energy has to be dissipated in the BTS3035EJ. This energy can be calculated by the following equation:

$$E = V_{OUT(CLAMP)} \times \left[ \frac{V_{BAT} - V_{OUT(CLAMP)}}{R_L} \times \ln \left( 1 - \frac{R_L \times I_L}{V_{BAT} - V_{OUT(CLAMP)}} \right) + I_L \right] \times \frac{L}{R_L} \quad (5.1)$$

Following equation simplifies under assumption of  $R_L = 0$

$$E = \frac{1}{2} L I_L^2 \times \left( 1 - \frac{V_{BAT}}{V_{BAT} - V_{OUT(CLAMP)}} \right) \quad (5.2)$$

For maximum single avalanche energy please also refer to EAS value in **“Energies” on Page 8**



**Figure 13 Maximum load inductance for single pulse**  
 $L = f(I_L), T_{J(0)} = T_{J,start} = 150^\circ\text{C}, V_{BAT} = 13.5\text{ V}$

**5.4 Reverse Current capability**

A reverse battery situation means the OUT pin is pulled below GND potentials to  $-V_{BAT}$  via the load  $Z_L$ .



## Power Stage

In this situation the load is driven by a current through the intrinsic body diode of the BTS3035EJ. During Reverse Battery all protection functions like current limitation, over temperature shut down and over voltage clamping are not available.

The device is dissipating a power loss which is defined by the driven current and the voltage drop on the DMOS reverse body diode “ $-V_{OUT}$ ”.

### 5.5 Inverse Current capability

An inverse current situation means the OUT pin is pulled below GND potential by a current flowing from GND to OUT (for example in half-bridge configuration and inductive load using freewheeling via the low side path). In this situation the load is driven by a current through the intrinsic body diode (device off) of the BTS3035EJ. During Inverse operation all protection functions like current limitation, over temperature shut down and over voltage clamping are not available.

The device is dissipating a power loss which is defined by the driven current and the voltage drop on the DMOS reverse body diode “ $-V_{OUT}$ ”.

#### Input current behavior during inverse condition on Output

Please note that during inverse current on drain an increased input current can flow ( $I_{IN(-VOUT)}$ ). To limit this current it is needed to place a resistor ( $R_{IN}$ ) in line with the input, also to prevent the microcontroller I/O pins from latching up in this case. The value of this resistor is a compromise of input voltage level in normal operation and maximum allowed device input current  $I_{IN}$  or I/O current (for example of microcontroller).

$$R_{IN(\min)} = \frac{V_{OH\mu C(\max)}}{I_{IN(\max)}} \quad (5.3)$$

with  $I_{IN(\max)} = 2 \text{ mA}$  (see also **“Absolute Maximum Ratings” on Page 8**) allow for the device;  
 $V_{OH\mu C(\max)}$  maximum high level voltage of the control signal (microcontroller I/O)  
and assuming  $-V_{OUT} = 1.1 \text{ V}$  (worst case) in inverse condition on the output

If inverse current occurs while the STATUS is active (LOW), the STATUS will be reset (HIGH) after the inverse current disappears.

### 5.6 Characteristics

Please see **“Power Stage” on Page 14** for electrical characteristic table.

**Protection Functions**

**6 Protection Functions**

The device provides embedded protection functions. Integrated protection functions are designed to prevent IC destruction under fault conditions described in the datasheet. Fault conditions are considered as “outside” normal operation. Protection functions are not designed for continuous repetitive operation.

**6.1 Over Voltage Clamping on OUTPUT**

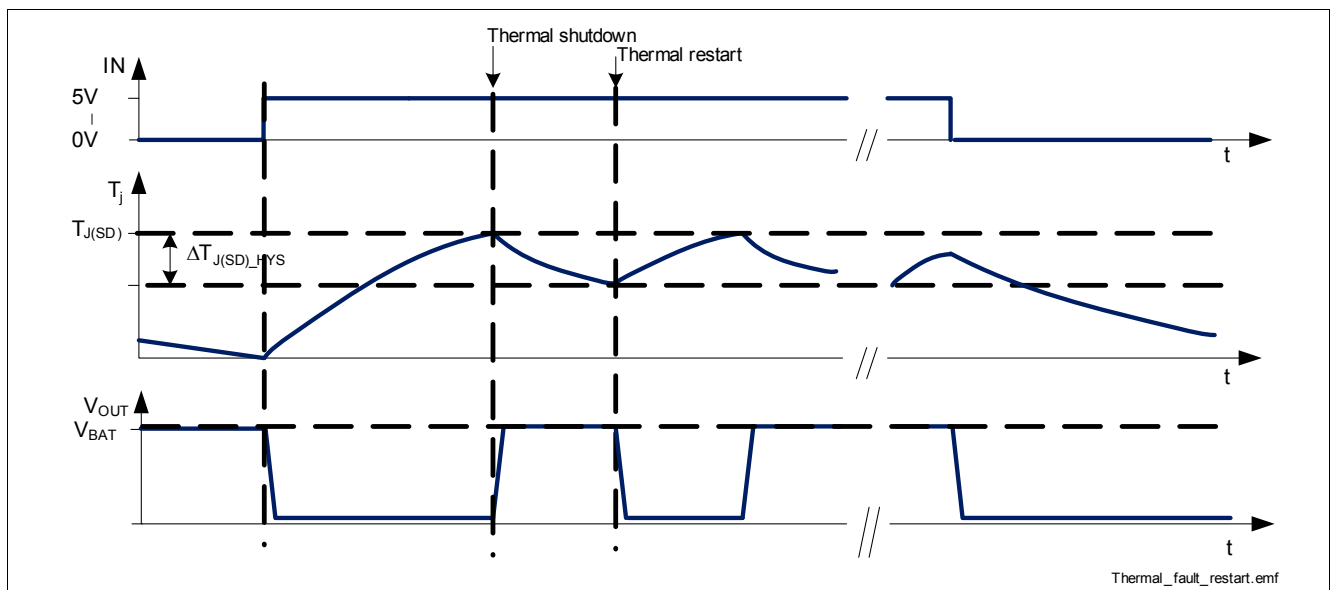
The BTS3035EJ is equipped with a voltage clamp circuitry that keeps the drain-source (output to GND) voltage  $V_{DS}$  at a certain level  $V_{OUT(CLAMP)}$ . The over voltage clamping is overruling the other protection functions. Power dissipation has to be limited to not exceed the maximum allowed junction temperature.

This function is also used in terms of inductive clamping. Please see also [Chapter 5.3.1](#) for more details.

**6.2 Thermal Protection**

The device is protected against over temperature due to overload and / or bad cooling conditions. To ensure this a temperature sensor is located in the power MOSFET.

The BTS3035EJ has a thermal protection function with automatic restart. After the device has switched off due to over temperature the device will stay off until the junction temperature has dropped down below the thermal hysteresis **“Thermal Protection” on Page 18**.



**Figure 14 Thermal protective switch OFF scenario with thermal restart**

The device also features a digital feedback on the dedicated status pin. This feedback is latched and can be read out easily by the microcontroller. Please see **“Diagnostics” on Page 21** for details on this feedback.

**6.3 Short Circuit Protection / Current limitation**

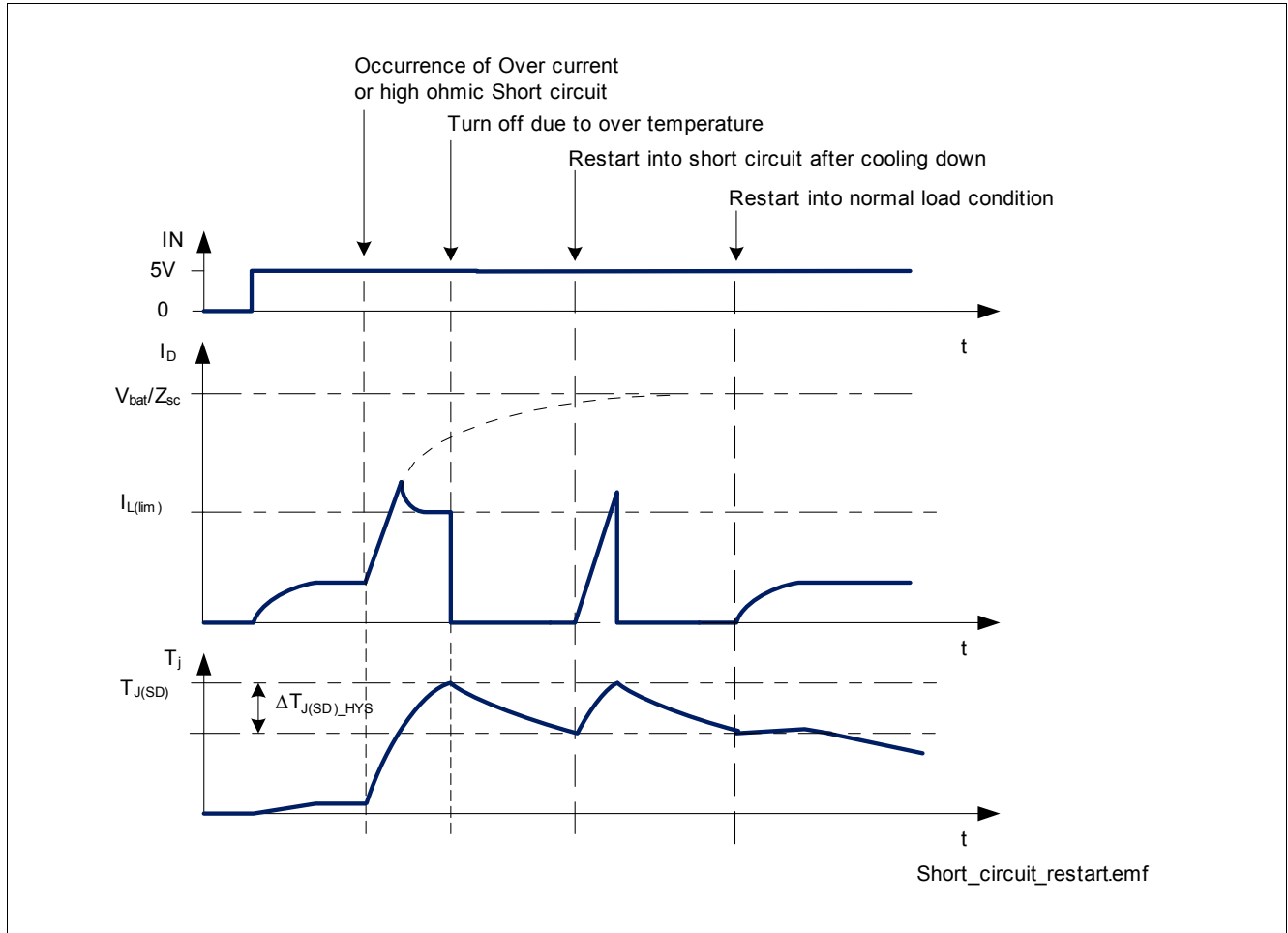
The condition short circuit is an overload condition to the device. If the load current reaches the limitation value of  $I_{L(LIM)}$  the device limits the current and therefore will start heating up. When the thermal shutdown temperature is reached, the device turns off.

The time from the beginning of current limitation until the over temperature switch off depends strongly on the cooling conditions.

**Protection Functions**

If input is still high the device will turn on again after the measured temperature has dropped below the thermal hysteresis.

**Figure 15** shows this simplified behavior.



**Figure 15 Short circuit protection via current limitation and over temperature switch off with auto-restart**

**6.4 Characteristics**

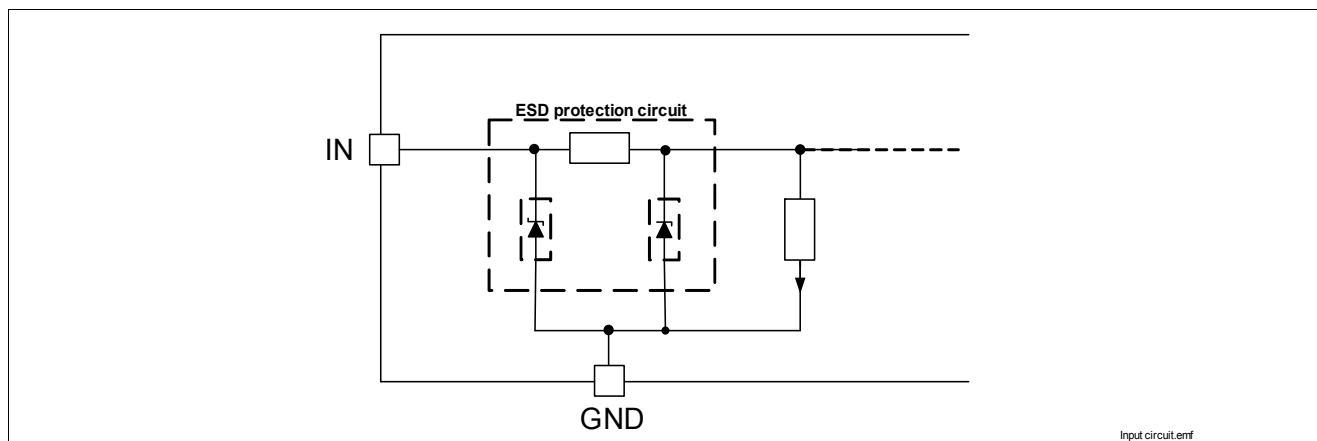
Please see **“Protection Functions” on Page 18** for electrical characteristic table.

Input Stage

## 7 Input Stage

### 7.1 Input Circuit

**Figure 16** shows the input circuit of the BTS3035EJ. In case of open or floating input pin the device will automatically switch off and remain off. An ESD Zener structure protects the input circuit against ESD pulses.



**Figure 16** Simplified Input circuitry

### 7.2 Characteristics

Please see **“Input Stage” on Page 25** for electrical characteristic table.

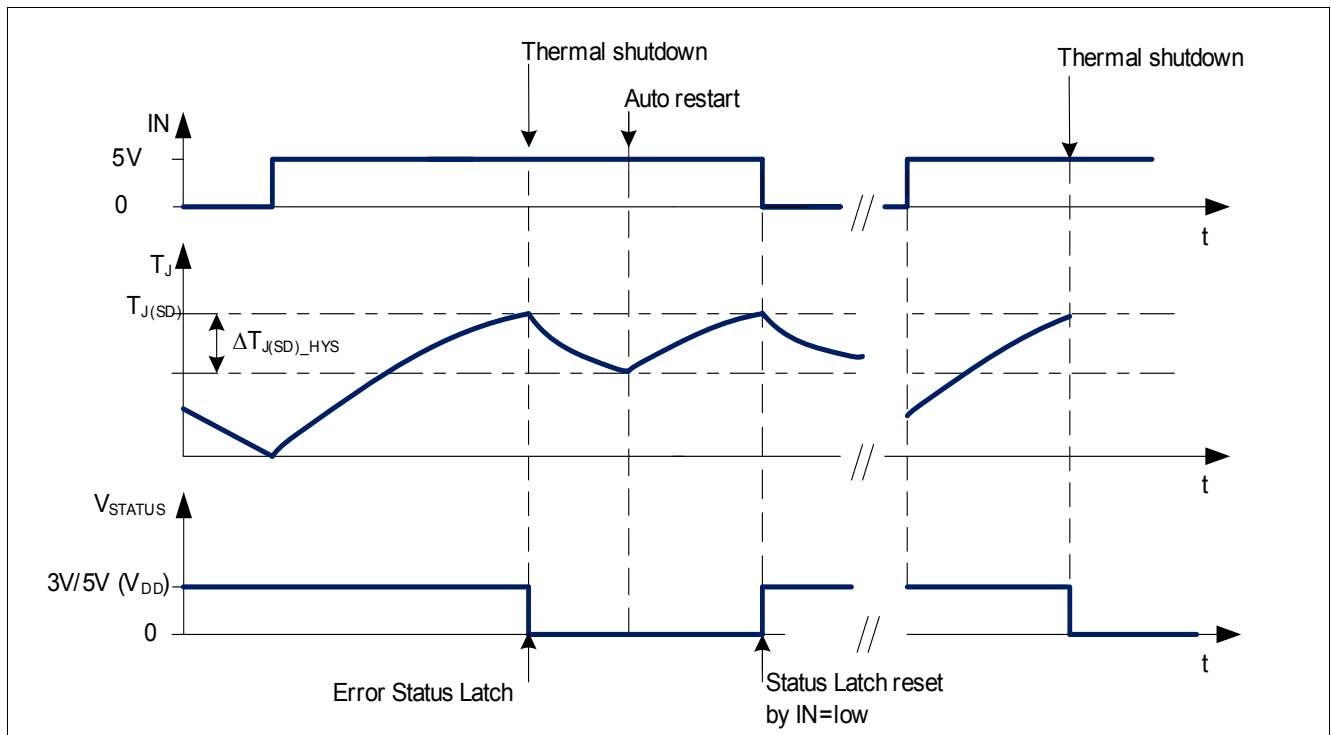
**Diagnostics**

**8 Diagnostics**

The BTS3035EJ provides a latching digital status signal via an open drain style feedback on the STATUS pin. In case of a detected over temperature condition, the device pulls the STATUS pin down to GND (pin) by an internal pull-down intend to signal a low level to the micro controller. This pull-down signal stays active also during thermal restart until the input pin is pulled-down below the input threshold.

In normal operation the status needs to be externally pulled up to a 3 V/5 V supply to signal a high level.

**Figure 17** shows this simplified behavior.



**Figure 17 Short circuit protection via current limitation and over temperature switch off with auto-restart and signaling via STATUS pin**

**Electrical Characteristics**

**9 Electrical Characteristics**

**9.1 Power Stage**

Please see Chapter **“Power Stage” on Page 14** for parameter description and further details.

**Table 5 Electrical Characteristics: Power Stage**

$T_j = -40^\circ\text{C}$  to  $+150^\circ\text{C}$ ,  $V_{\text{BAT}} = 6\text{ V}$  to  $18\text{ V}$ , all voltages with respect to ground, positive current flowing into pin (unless otherwise specified)

| Parameter   | Symbol                    | Values |      |      | Unit | Note or Test Condition   | Number   |
|---|---------------------------|--------|------|------|------|--|----------|
|   |                           | Min.   | Typ. | Max. |      |  |          |
| <b>Power Stage</b>                                |                           |        |      |      |      |  |          |
| On-State resistance at hot temperature (150°C)    | $R_{\text{DS(ON)}_{150}}$ | –      | 58   | 70   | mΩ   | $T_j = 150^\circ\text{C}$ ;<br>$V_{\text{IN}} = 5\text{ V}$ ;<br>$I_L = I_{\text{L(NOM)}}$                           | P_9.1.3  |
| On-State resistance at ambient temperature (25°C) | $R_{\text{DS(ON)}_{25}}$  | –      | 30   | –    | mΩ   | $T_j = 25^\circ\text{C}$ ;<br>$V_{\text{IN}} = 5\text{ V}$ ;<br>$I_L = I_{\text{L(NOM)}}$                            | P_9.1.9  |
| Nominal load current                              | $I_{\text{L(NOM)}}$       | –      | 5    | –    | A    | <sup>1)</sup><br>$T_j < 150^\circ\text{C}$ ;<br>$T_A = 85^\circ\text{C}$<br>$V_{\text{IN}} = 5\text{ V}$             | P_9.1.39 |
| OFF state load current, Output leakage current    | $I_{\text{L(OFF)}_{85}}$  | –      | –    | 0.6  | μA   | <sup>2)</sup><br>$V_{\text{BAT}} = 13.5\text{ V}$ ;<br>$V_{\text{IN}} = 0\text{ V}$ ;<br>$T_j \leq 85^\circ\text{C}$ | P_9.1.45 |
| OFF state load current, Output leakage current    | $I_{\text{L(OFF)}_{150}}$ | –      | 1.3  | 4.3  | μA   | $V_{\text{BAT}} = 18\text{ V}$ ;<br>$V_{\text{IN}} = 0\text{ V}$ ;<br>$T_j = 150^\circ\text{C}$                      | P_9.1.51 |
| Reverse body diode forward voltage                | $-V_{\text{OUT}}$         | –      | 0.8  | 1.1  | V    | $I_L = -I_{\text{L(NOM)}}$ ;<br>$V_{\text{IN}} = 0\text{ V}$   | P_9.1.67 |

**Electrical Characteristics**

**Table 5 Electrical Characteristics: Power Stage (cont'd)**

$T_j = -40^{\circ}\text{C}$  to  $+150^{\circ}\text{C}$ ,  $V_{\text{BAT}} = 6\text{ V}$  to  $18\text{ V}$ , all voltages with respect to ground, positive current flowing into pin (unless otherwise specified)

| Parameter   | Symbol                             | Values |      |      | Unit                   | Note or Test Condition  | Number   |
|---|------------------------------------|--------|------|------|------------------------|---|----------|
|   |                                    | Min.   | Typ. | Max. |                        |   |          |
| <b>Dynamic characteristics - switching timesingle pulse <math>V_{\text{BAT}} = 13.5\text{ V}</math>, <math>R_L = 2.2\Omega</math>;</b><br><b>for definition details see <a href="#">Figure 10 "Definition of Power Output Timing for Resistive Load"</a> on Page 14</b> |                                    |        |      |      |                        |   |          |
| Turn-on time  | $t_{\text{ON}}$                    | 35     | 75   | 115  | $\mu\text{s}$          | <sup>3)</sup><br>$V_{\text{IN}} = 0\text{ V}$ to $5\text{ V}$ ;<br>$V_{\text{OUT}} = 10\% V_{\text{BAT}}$                             | P_9.1.68 |
| Turn-off time   | $t_{\text{OFF}}$                   | 70     | 135  | 210  | $\mu\text{s}$          | <sup>4)</sup><br>$V_{\text{IN}} = 5\text{ V}$ to $0\text{ V}$ ;<br>$V_{\text{OUT}} = 90\% V_{\text{BAT}}$                             | P_9.1.69 |
| Turn-on delay time  | $t_{\text{DON}}$                   | 5      | 15   | 25   | $\mu\text{s}$          | $V_{\text{IN}} = 0\text{ V}$ to $5\text{ V}$ ;<br>$V_{\text{OUT}} = 90\% V_{\text{BAT}}$  | P_9.1.70 |
| Turn-off delay time   | $t_{\text{DOFF}}$                  | 40     | 75   | 120  | $\mu\text{s}$          | $V_{\text{IN}} = 5\text{ V}$ to $0\text{ V}$ ;<br>$V_{\text{OUT}} = 10\% V_{\text{BAT}}$  | P_9.1.71 |
| Fall time, Falling output voltage (turn-on)   | $t_{\text{F}}$                     | 30     | 60   | 90   | $\mu\text{s}$          | $V_{\text{IN}} = 0\text{ V}$ to $5\text{ V}$ ;<br>$V_{\text{OUT}} = 90\% V_{\text{BAT}}$ to<br>$V_{\text{OUT}} = 10\% V_{\text{BAT}}$ | P_9.1.72 |
| Rise time, Rising output voltage  | $t_{\text{R}}$                     | 30     | 60   | 90   | $\mu\text{s}$          | $V_{\text{IN}} = 5\text{ V}$ to $0\text{ V}$ ;<br>$V_{\text{OUT}} = 10\% V_{\text{BAT}}$ to<br>$V_{\text{OUT}} = 90\% V_{\text{BAT}}$ | P_9.1.73 |
| Turn-on Slew rate   | $-(\Delta V/\Delta t)_{\text{ON}}$ | 0.22   | 0.45 | 0.65 | $\text{V}/\mu\text{s}$ | <sup>5)</sup><br>$V_{\text{OUT}} = 90\% V_{\text{BAT}}$ to<br>$V_{\text{OUT}} = 50\% V_{\text{BAT}}$                                  | P_9.1.74 |
| Turn-off Slew rate  | $(\Delta V/\Delta t)_{\text{OFF}}$ | 0.22   | 0.45 | 0.65 | $\text{V}/\mu\text{s}$ | <sup>6)</sup><br>$V_{\text{OUT}} = 50\% V_{\text{BAT}}$ to<br>$V_{\text{OUT}} = 90\% V_{\text{BAT}}$                                  | P_9.1.75 |

- 1) Not subject to production test, calculated by  $R_{\text{thJA}}$  (JEDEC 2s2p, PCB) and  $R_{\text{DS(ON)}}$
- 2) Not subject to production test, specified by design;
- 3) Not subject to production test, calculated with delay time ON and fall time
- 4) Not subject to production test, calculated with delay time OFF and rise time
- 5) Not subject to production test, calculated slew rate between 90% and 50%  $V_{\text{OUT}}$
- 6) Not subject to production test, calculated slew rate between 50% and 90%  $V_{\text{OUT}}$

**Electrical Characteristics**

**9.2 Protection**

Please see Chapter “**Protection Functions**” on Page 18 for parameter description and further details.

*Note: Integrated protection functions are designed to prevent IC destruction under fault conditions described in the data sheet. Fault conditions are considered as “outside” normal operating range. Protection functions are not designed for continuous repetitive operation*

**Table 6 Electrical Characteristics: Protection**

$T_j = -40^{\circ}\text{C}$  to  $+150^{\circ}\text{C}$ ,  $V_{\text{BAT}} = 6\text{ V}$  to  $18\text{ V}$ , all voltages with respect to ground, positive current flowing into pin (unless otherwise specified)

| Parameter                                      | Symbol                     | Values |      |      | Unit               | Note or Test Condition   | Number   |
|--|----------------------------|--------|------|------|--------------------|--|----------|
|  |                            | Min.   | Typ. | Max. |                    |  |          |
| <b>Thermal Protection</b>                      |                            |        |      |      |                    |  |          |
| Thermal shut down junction temperature         | $T_{\text{J(SD)}}$         | 150    | 175  | –    | $^{\circ}\text{C}$ | <sup>1)</sup><br>$3\text{ V} < V_{\text{IN}} < 5.5\text{ V}$   | P_9.2.1  |
| Thermal hysteresis                             | $\Delta T_{\text{J\_HYS}}$ | –      | 15   | –    | K                  | <sup>1)</sup>  | P_9.2.3  |
| Minimum status latch reset time                | $t_{\text{RESET}}$         | 50     | –    | –    | $\mu\text{s}$      | <sup>1) 2)</sup><br>$V_{\text{IN}} < 0.8\text{ V};$            | P_9.2.8  |
| <b>Overvoltage Protection</b>                  |                            |        |      |      |                    |  |          |
| Drain clamp voltage                            | $V_{\text{OUT(CLAMP)}}$    | 40     | 45   | –    | V                  | $V_{\text{IN}} = 0\text{ V};$<br>$I_{\text{L}} = 14\text{ mA}$ | P_9.2.11 |
| <b>Current limitation (see also Figure 15)</b> |                            |        |      |      |                    |  |          |
| Current limitation                             | $I_{\text{L(LIM)}}$        | 20     | 30   | 40   | A                  | $V_{\text{IN}} = 5\text{ V}$                                   | P_9.2.17 |

- 1) Not subject to production test, specified by design.
- 2) Minimum time needed to reset the STATUS latch feedback signal



**Electrical Characteristics**

**9.3 Input Stage**

Please see Chapter “**Input Stage**” on **Page 20** for description and further details.

**Table 7 Electrical Characteristics: Input**

$T_j = -40^\circ\text{C}$  to  $+150^\circ\text{C}$ ,  $V_{\text{BAT}} = 6\text{ V}$  to  $18\text{ V}$ , all voltages with respect to ground, positive current flowing into pin (unless otherwise specified)

| Parameter                                      | Symbol                 | Values |      |      | Unit          | Note or Test Condition   | Number   |
|--|------------------------|--------|------|------|---------------|--|----------|
|  |                        | Min.   | Typ. | Max. |               |  |          |
| <b>Input</b>                                   |                        |        |      |      |               |  |          |
| Input Current, normal ON state                 | $I_{\text{IN(ON)}}$    | –      | 82   | 120  | $\mu\text{A}$ | $V_{\text{IN}} = 5.0\text{ V}$ ;   | P_9.3.1  |
| Input Current, protection mode                 | $I_{\text{IN(PROT)}}$  | –      | 191  | 260  | $\mu\text{A}$ | $V_{\text{IN}} = 5.0\text{ V}$ ;   | P_9.3.5  |
| Input current, inverse condition on OUT to GND | $I_{\text{IN(-VOUT)}}$ | –      | 15   | –    | $\text{mA}$   | 1) 2)<br>$V_{\text{OUT}} < -0.3\text{ V}$ ;<br>$-0.3\text{ V} \leq V_{\text{IN}} < 5.5\text{ V}$ | P_9.3.9  |
| Input pull down current                        | $I_{\text{IN-GND}}$    | 10     | –    | –    | $\mu\text{A}$ | 3)<br>$V_{\text{IN}} = V_{\text{IN(TH)}}$  | P_9.3.10 |
| Input Voltage on-threshold                     | $V_{\text{IN(TH)}}$    | 0.8    | 2.3  | 3    | $\text{V}$    | $I_L = 1.4\text{ mA}$ ;<br>Power DMOS active   | P_9.3.11 |

- 1) Not subject to production test, specified by design
- 2) Input current must not exceed the maximum ratings in Chapter 4, P\_4.1.10
- 3) Not subject to production test, specified by design

**9.4 Diagnostics (STATUS Pin)**

Please see Chapter “**Diagnostics**” on **Page 21** for description and further details.

**Table 8 Electrical Characteristics: Diagnostics**

$T_j = -40^\circ\text{C}$  to  $+150^\circ\text{C}$ ,  $V_{\text{BAT}} = 6\text{ V}$  to  $18\text{ V}$ , all voltages with respect to ground, positive current flowing into pin (unless otherwise specified)

| Parameter                          | Symbol                       | Values |      |      | Unit          | Note or Test Condition  | Number  |
|------------------------------------|------------------------------|--------|------|------|---------------|---|---------|
|                                    |                              | Min.   | Typ. | Max. |               |   |         |
| Status pin voltage drop            | $V_{\text{STATUS(ON)}}$      | –      | –    | 0.65 | $\text{V}$    | $I_{\text{STATUS}} = 1\text{ mA}$ ;<br>latched fault;<br>$3\text{ V} \leq V_{\text{IN}} < 5.5\text{ V}$                       | P_9.4.1 |
| Status pin leakage current (85°C)  | $I_{\text{STATUS(OFF)_85}}$  | –      | 1.5  | 6    | $\mu\text{A}$ | 1)<br>$V_{\text{STATUS}} \leq 5.5\text{ V}$ ; $T_j \leq 85^\circ\text{C}$ ;<br>$3\text{ V} \leq V_{\text{IN}} < 5.5\text{ V}$ | P_9.4.2 |
| Status pin leakage current (150°C) | $I_{\text{STATUS(OFF)_150}}$ | –      | 6    | 12   | $\mu\text{A}$ | $V_{\text{STATUS}} \leq 5.0\text{ V}$ ;<br>$T_j = 150^\circ\text{C}$ ;<br>$3\text{ V} \leq V_{\text{IN}} < 5.5\text{ V}$      | P_9.4.3 |

- 1) Not subject to production test, specified by design.

Characterization Results

## 10 Characterization Results

Typical performance characteristics.

### 10.1 Power Stage

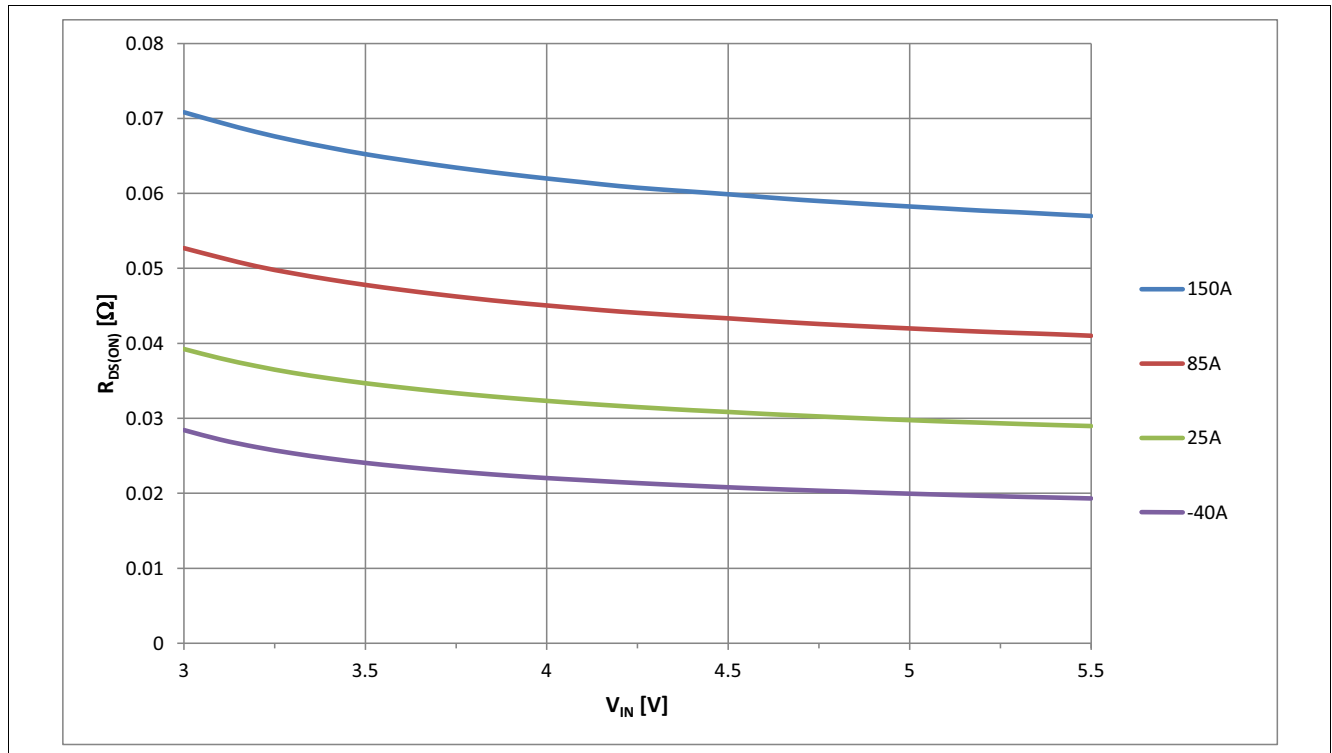
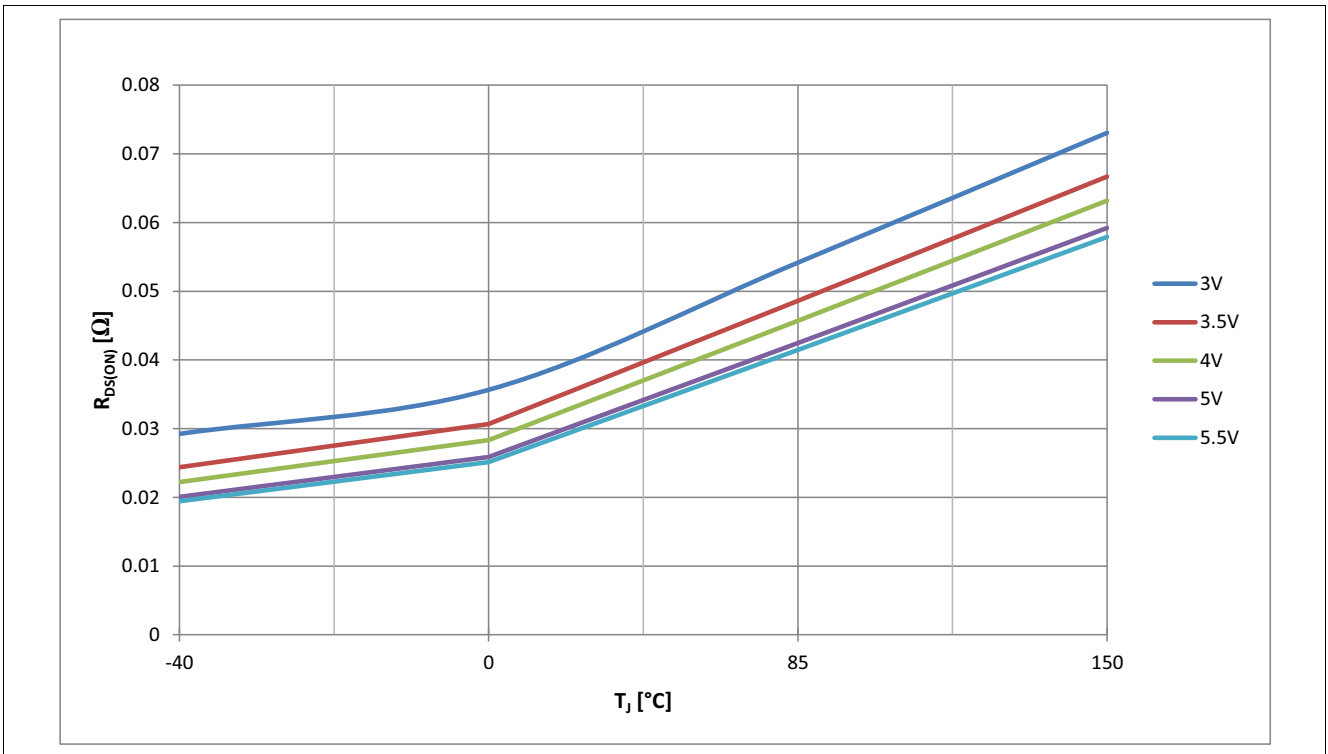
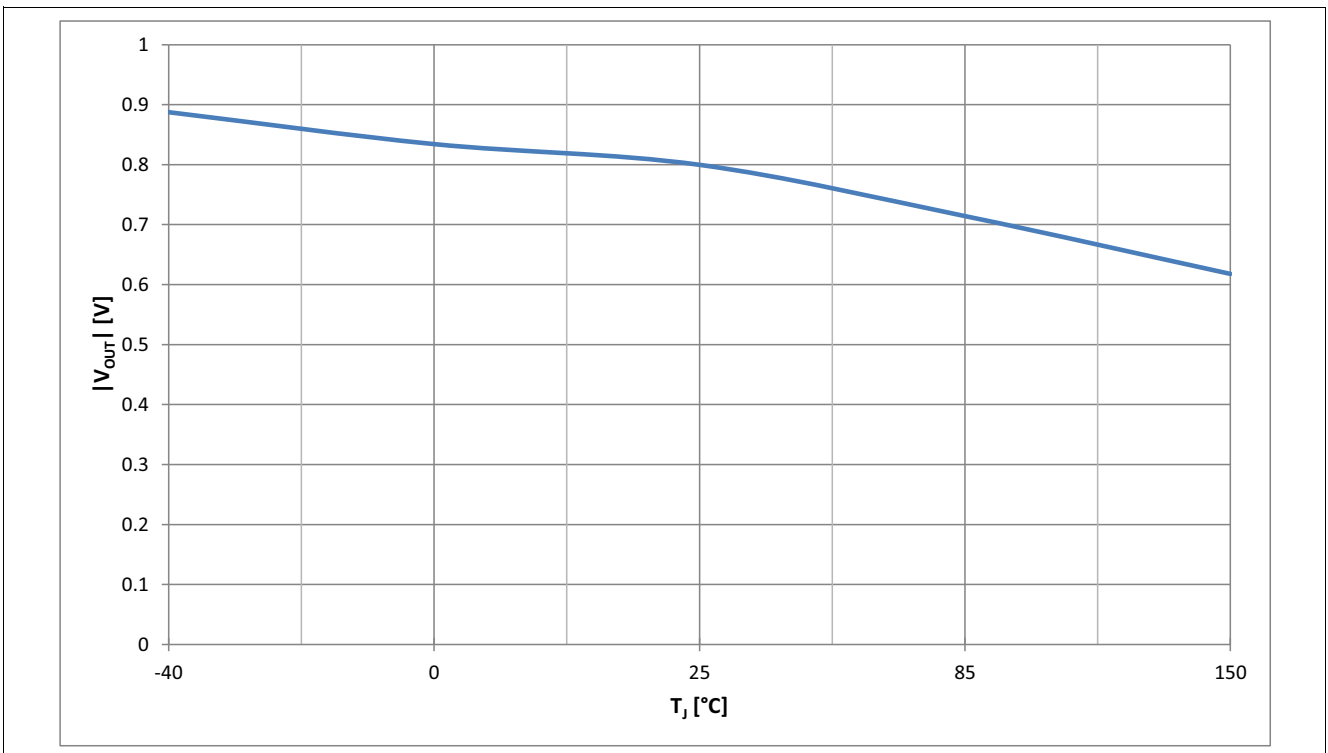


Figure 18 Typical  $R_{DS(ON)}$  vs.  $V_{IN}$  @  $T_J = -40 \dots 150^\circ\text{C}$ ,  $I_L = I_{L(NOM)}$

**Characterization Results**

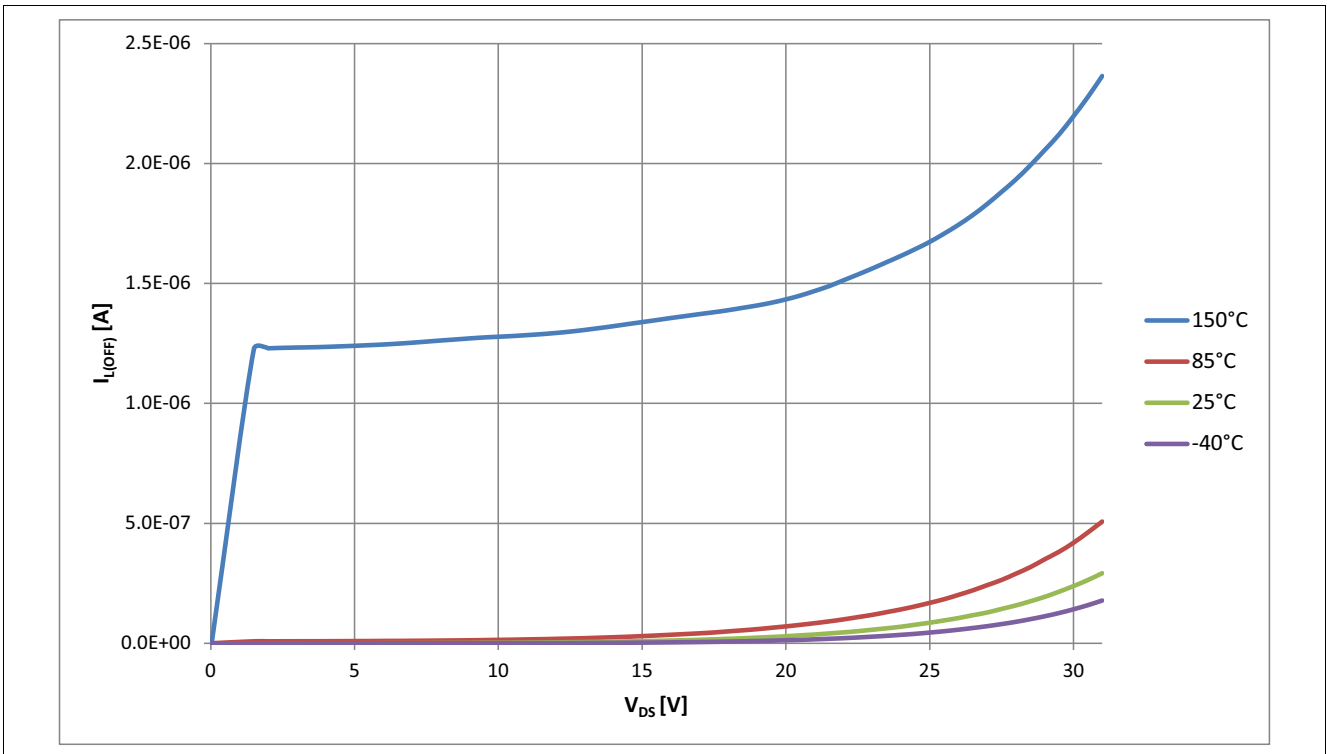


**Figure 19** typical  $R_{DS(ON)}$  vs.  $T_J$  @  $V_{IN} = 3 \dots 5.5 \text{ V}$ ;  $I_L = I_{L(NOM)}$

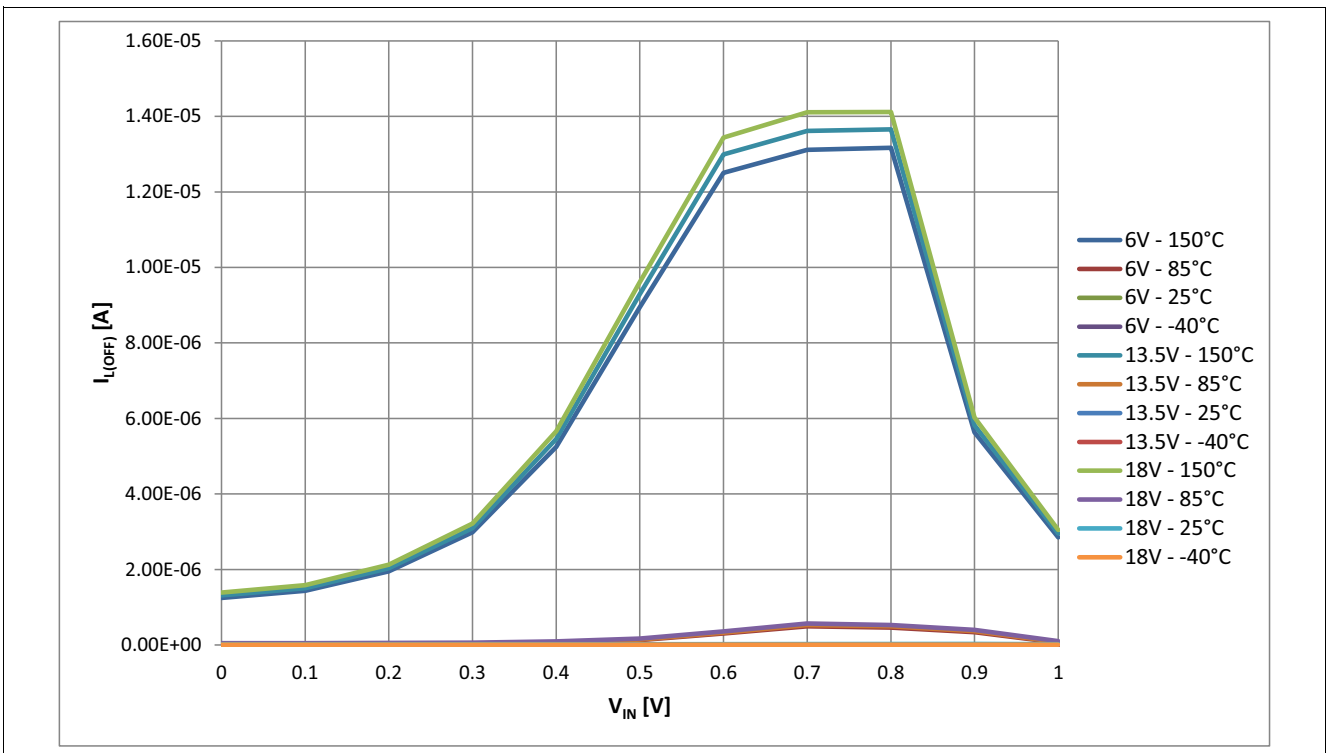


**Figure 20** Typical Reverse Diode  $|V_{OUT}|$  vs.  $T_J$  @  $I_L = -I_{L(NOM)}$

**Characterization Results**

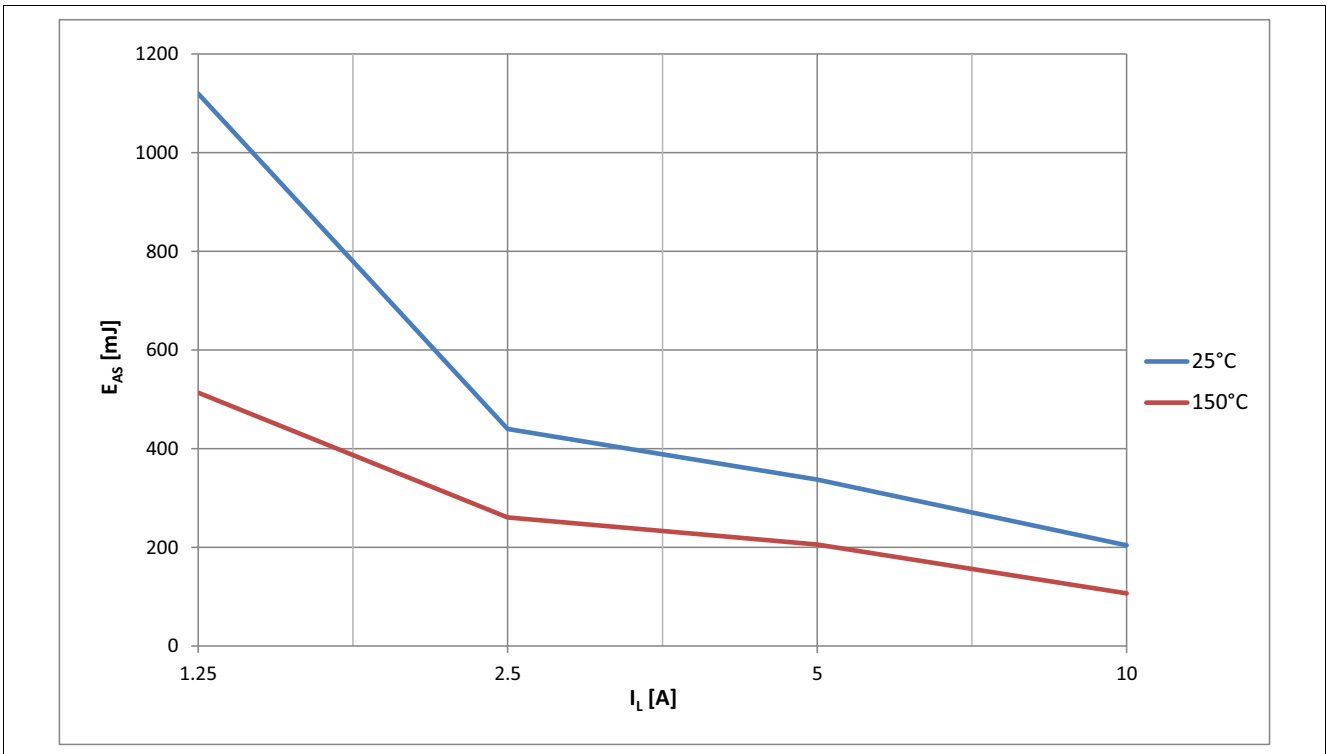


**Figure 21** Typical  $I_{L(OFF)}$  vs.  $V_{DS}$  @  $T_J = -40 \dots 150^\circ\text{C}$ ,  $V_{IN} = 0\text{ V}$

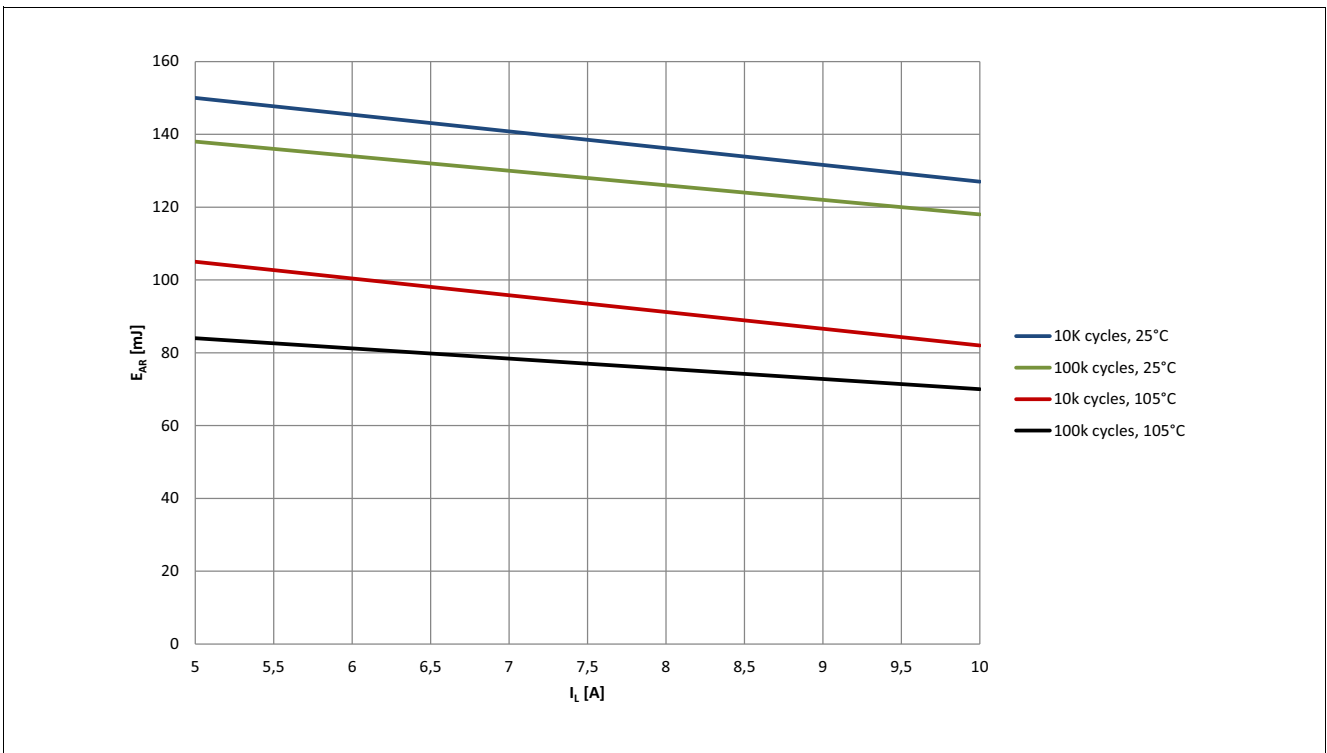


**Figure 22** Typical  $I_{L(OFF)}$  vs.  $V_{IN}$  @  $T_J = -40 \dots 150^\circ\text{C}$ ,  $V_{BAT} = 6 \dots 18\text{ V}$

**Characterization Results**

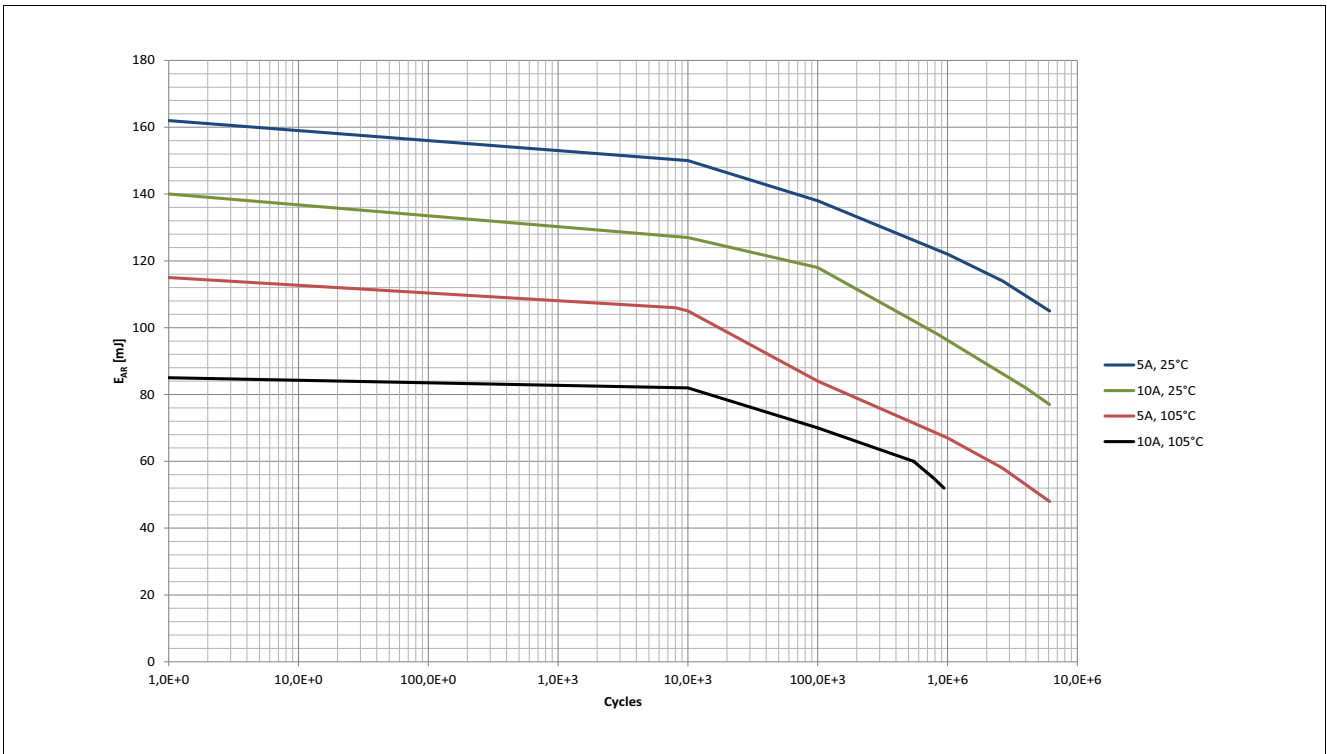


**Figure 23** Typical destruction point.  $E_{AS}$  vs.  $I_L$  @  $T_{J(0)} = 25^\circ\text{C}$  and  $150^\circ\text{C}$ ,  $V_{BAT} = 13.5\text{ V}$



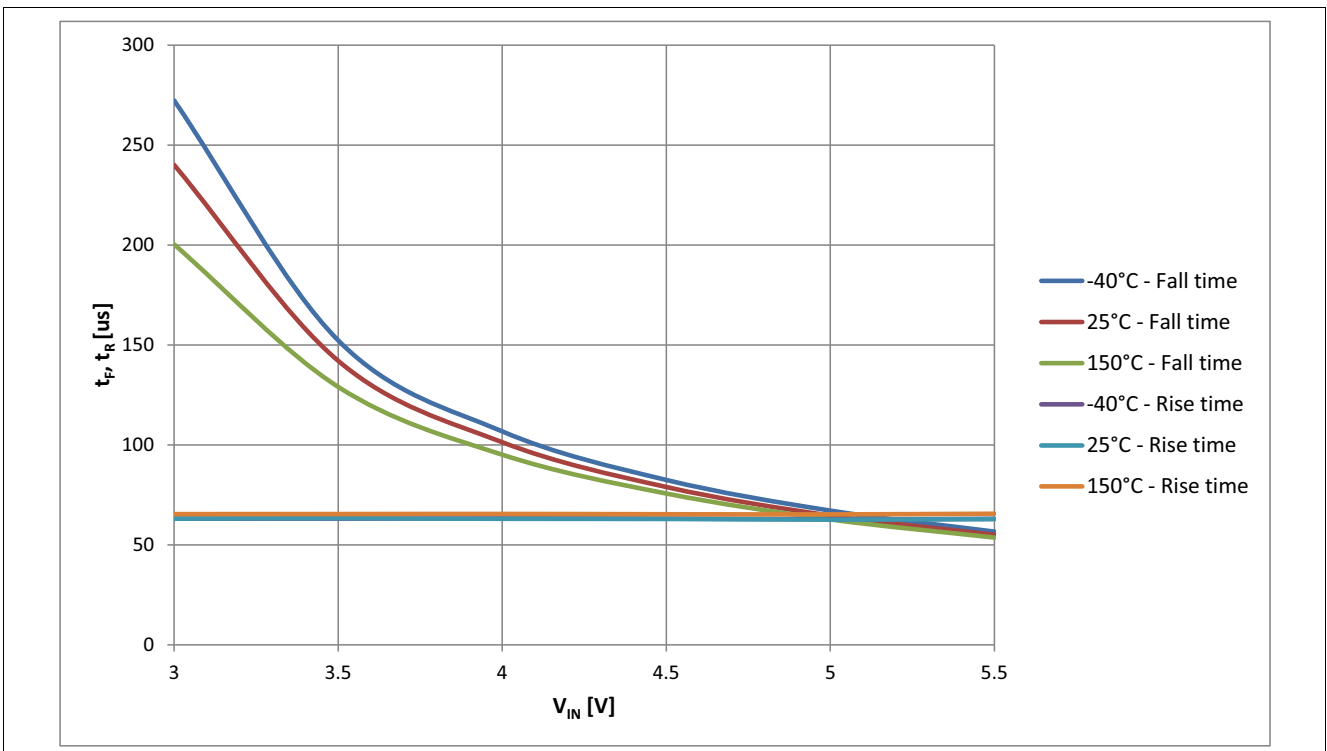
**Figure 24** Typical  $E_{AR}$  vs.  $I_L$  @  $T_{J(0)} = 25^\circ\text{C}$  and  $105^\circ\text{C}$ ,  $V_{BAT} = 13.5\text{ V}$

**Characterization Results**



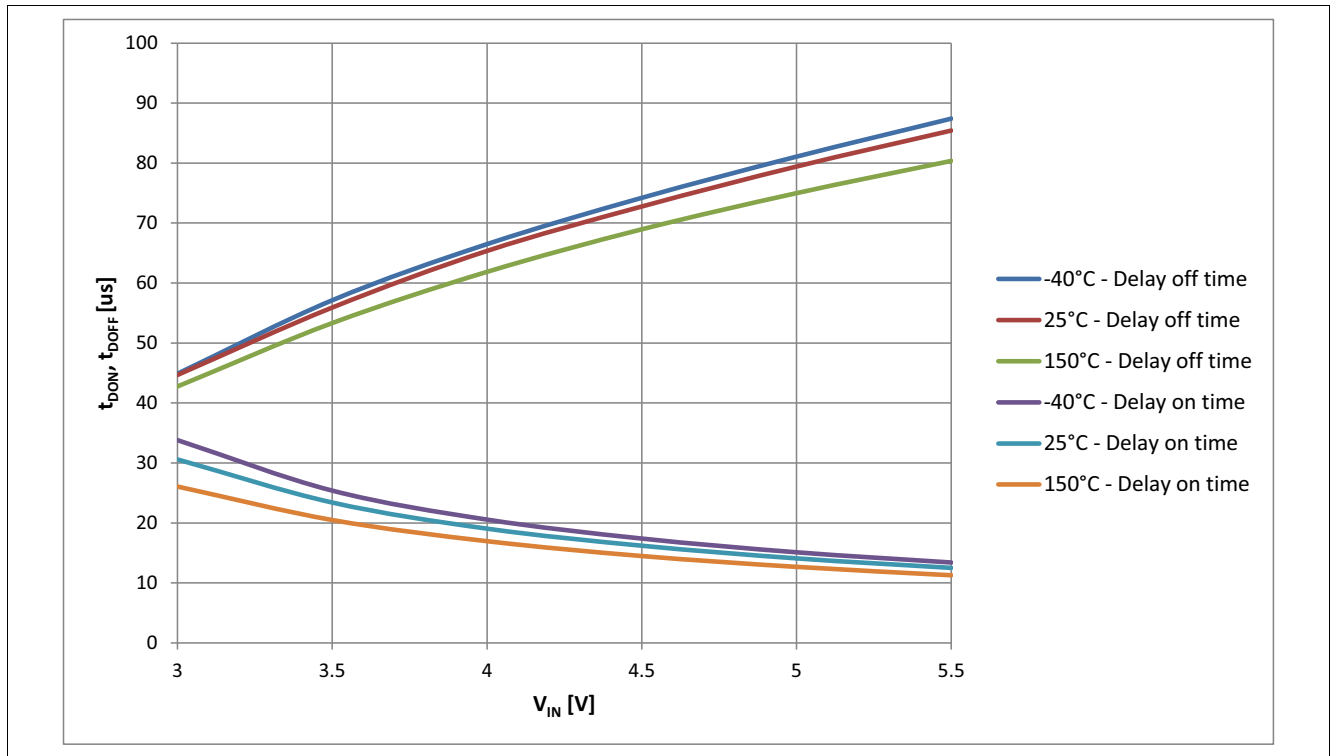
**Figure 25** Typical  $E_{AR}$  vs. Nr of cycles @  $T_{J(0)} = 25^{\circ}\text{C}$  and  $105^{\circ}\text{C}$ ,  $V_{BAT} = 13.5\text{ V}$

**Dynamic characteristics (switching times):**

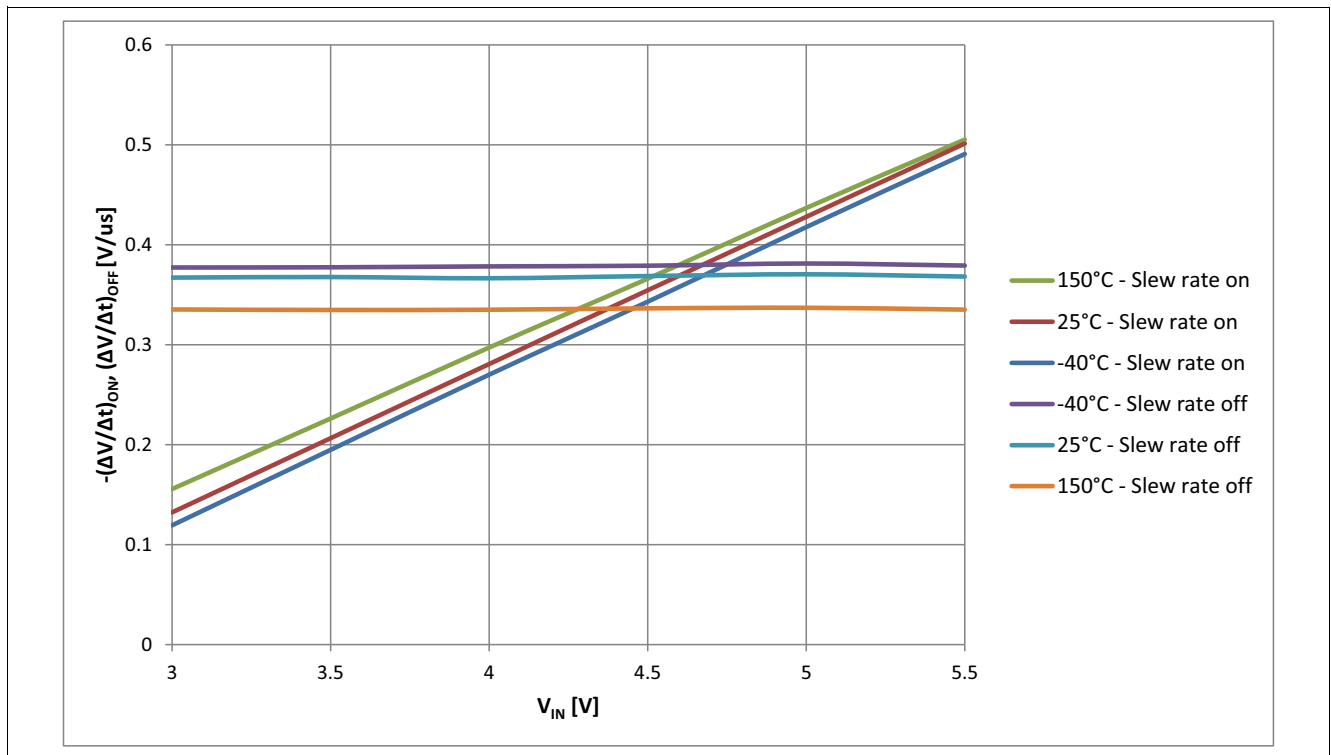


**Figure 26** Typical  $t_F, t_R$  vs  $V_{IN}$  @  $T_J = -40 \dots 150^{\circ}\text{C}$

**Characterization Results**

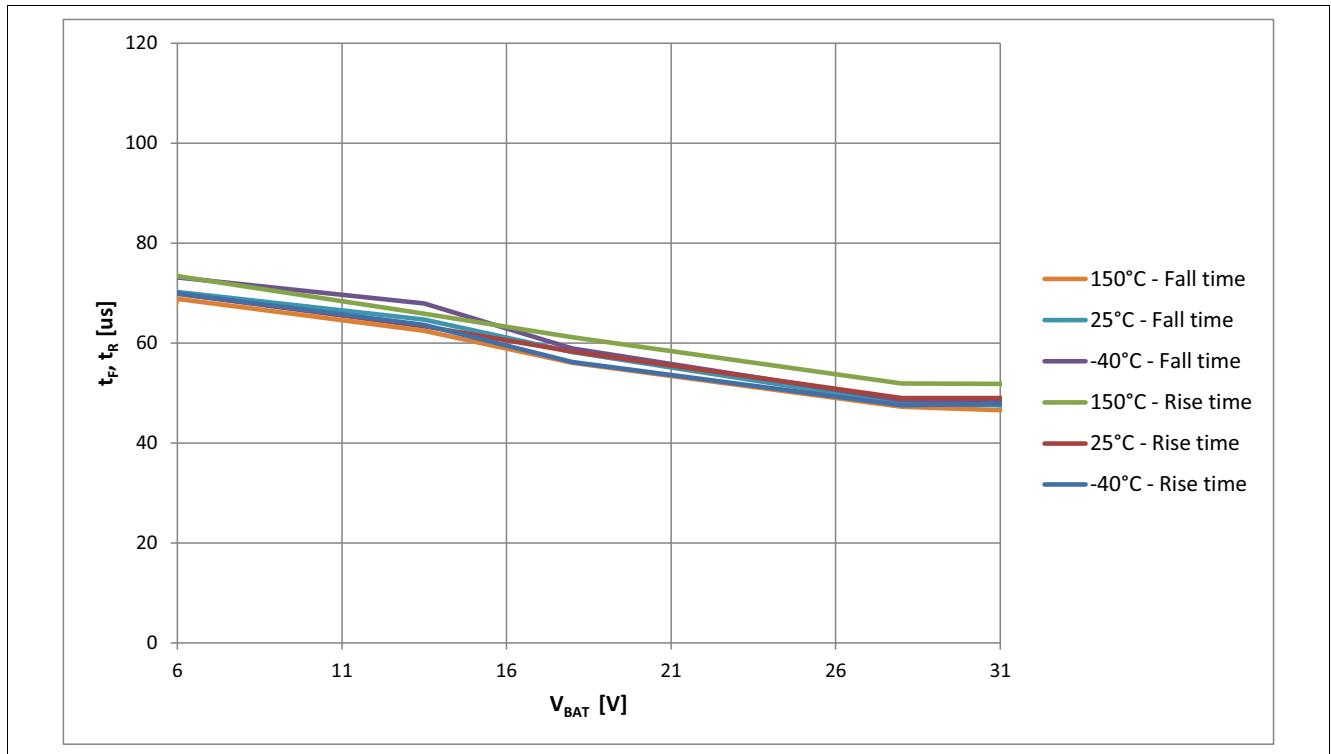


**Figure 27** Typical  $t_{DON}$ ,  $t_{DOFF}$  vs  $V_{IN}$  @  $T_J = -40 \dots 150^\circ\text{C}$

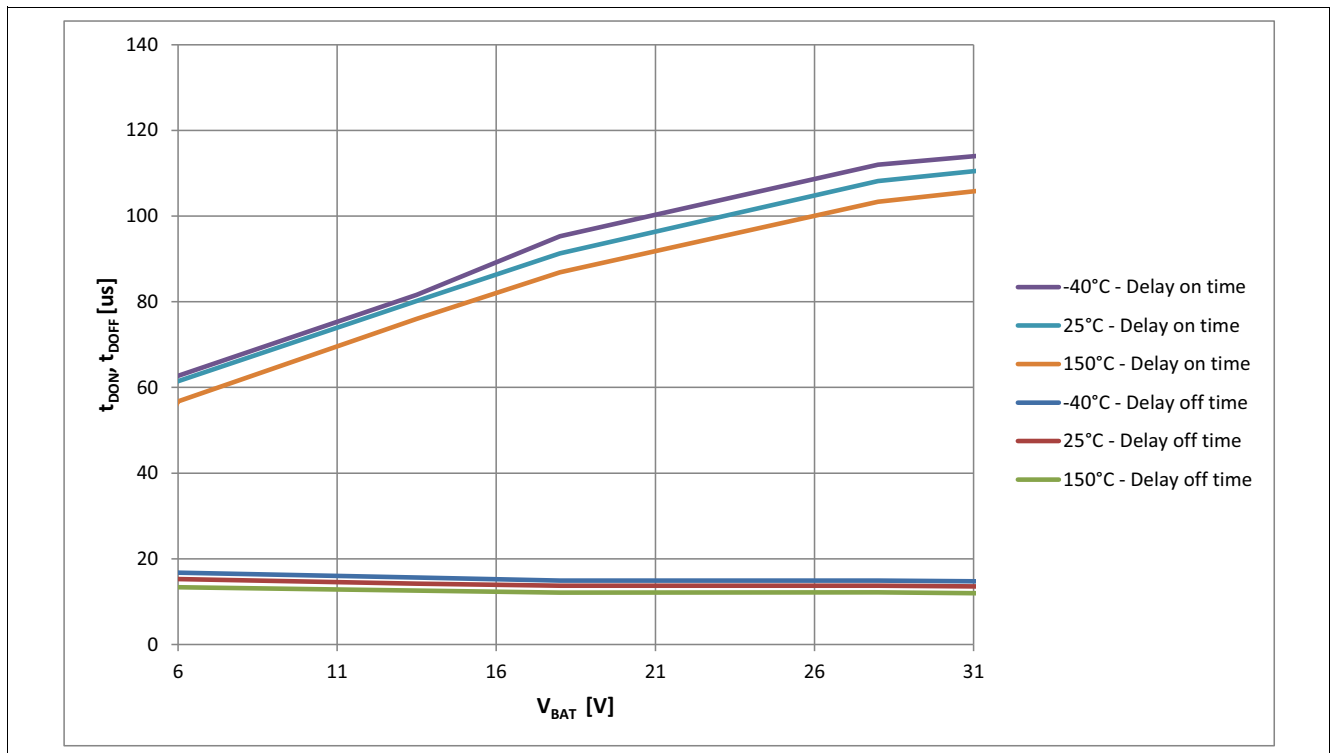


**Figure 28** Typical  $-(\Delta V/\Delta t)_{ON}$ ,  $(\Delta V/\Delta t)_{OFF}$  vs  $V_{IN}$  @  $T_J = -40 \dots 150^\circ\text{C}$

**Characterization Results**



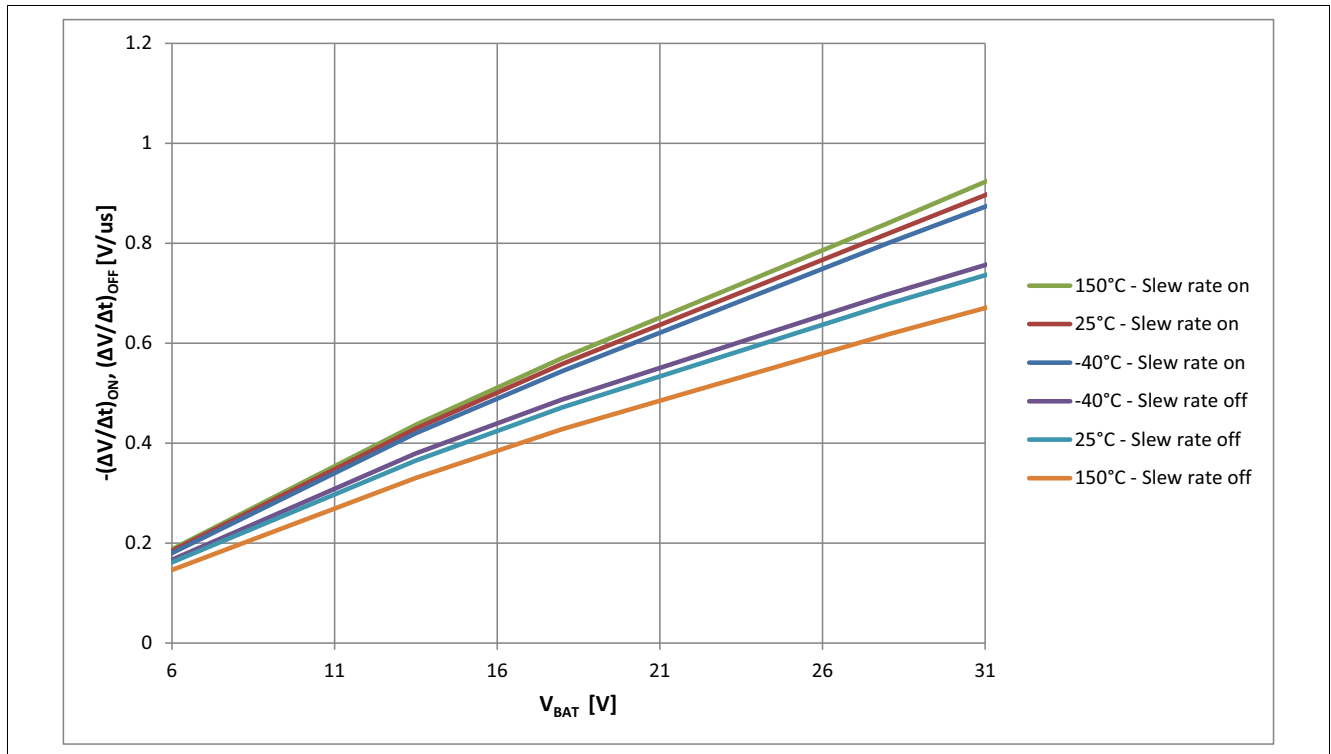
**Figure 29** Typical  $t_F$ ,  $t_R$  vs  $V_{BAT}$  @  $V_{IN} = 5\text{ V}$ ,  $T_J = -40 \dots 150^\circ\text{C}$



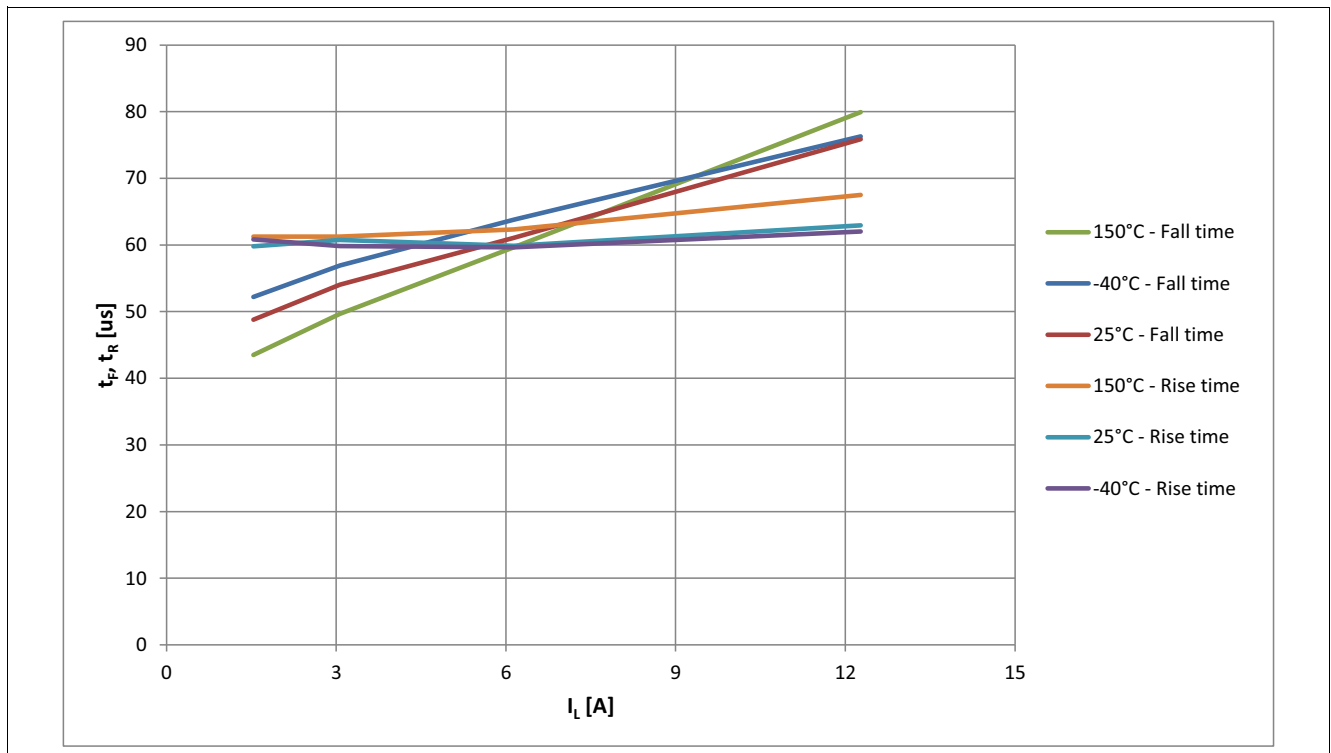
**Figure 30** Typical  $t_{DON}$ ,  $t_{DOFF}$  vs  $V_{BAT}$  @  $V_{IN} = 5\text{ V}$ ,  $T_J = -40 \dots 150^\circ\text{C}$



**Characterization Results**

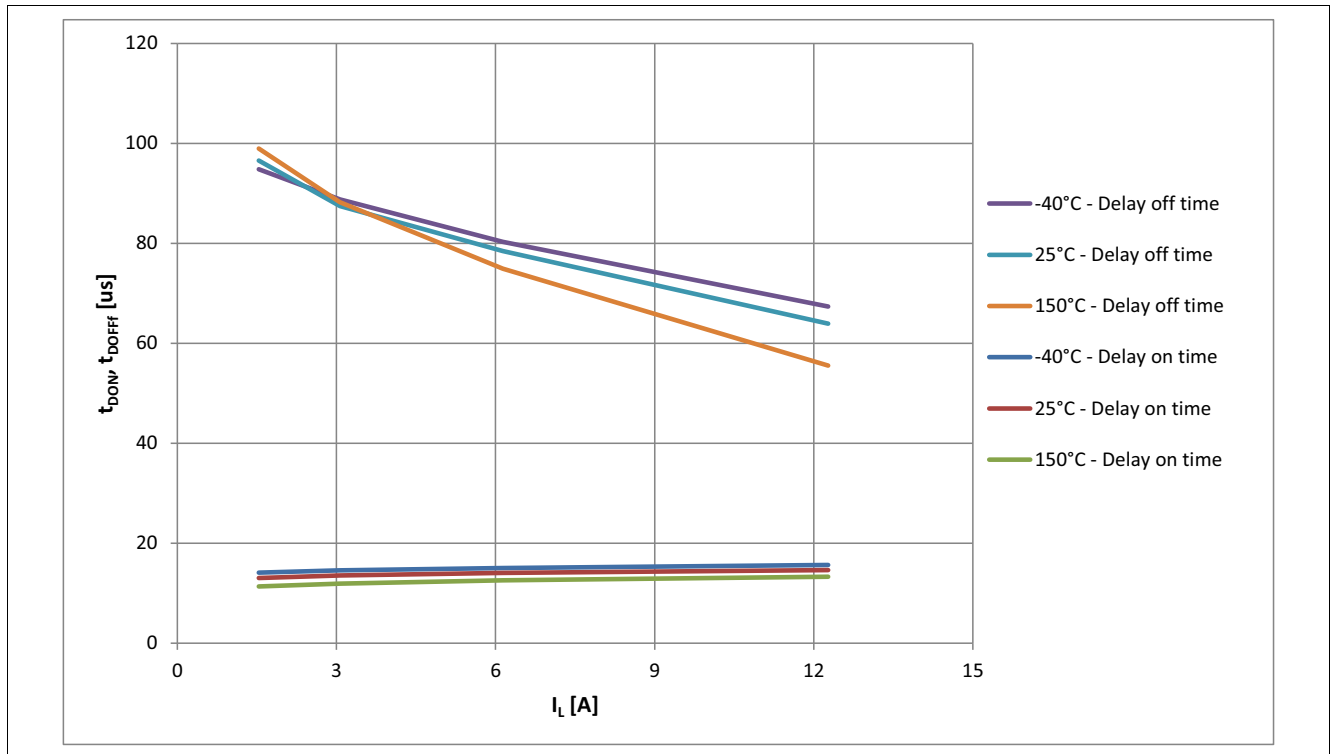


**Figure 31** Typical  $-(\Delta V/\Delta t)_{ON}$ ,  $(\Delta V/\Delta t)_{OFF}$  vs  $V_{BAT}$  @  $V_{IN} = 5\text{ V}$ ,  $T_J = -40 \dots 150^\circ\text{C}$

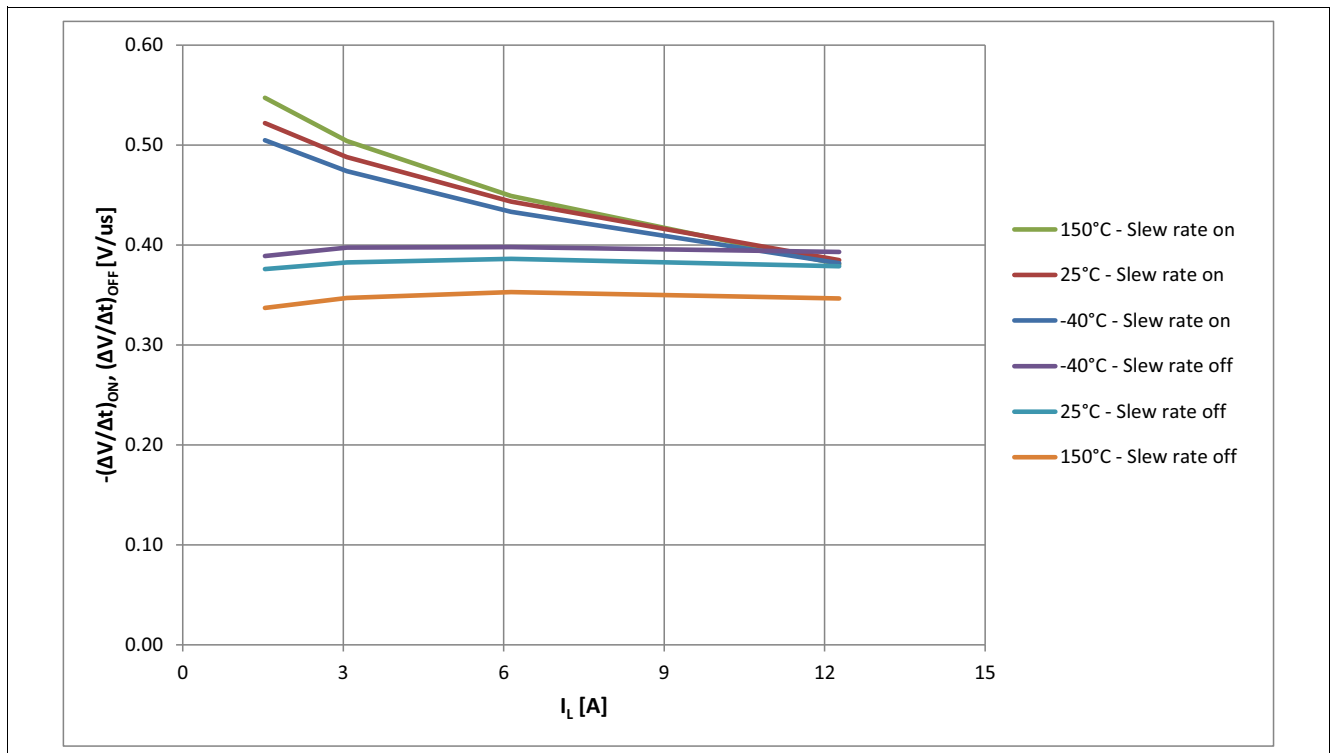


**Figure 32** Typical  $t_F$ ,  $t_R$  vs  $I_L$  @  $V_{IN} = 5\text{ V}$ ,  $T_J = -40 \dots 150^\circ\text{C}$

**Characterization Results**

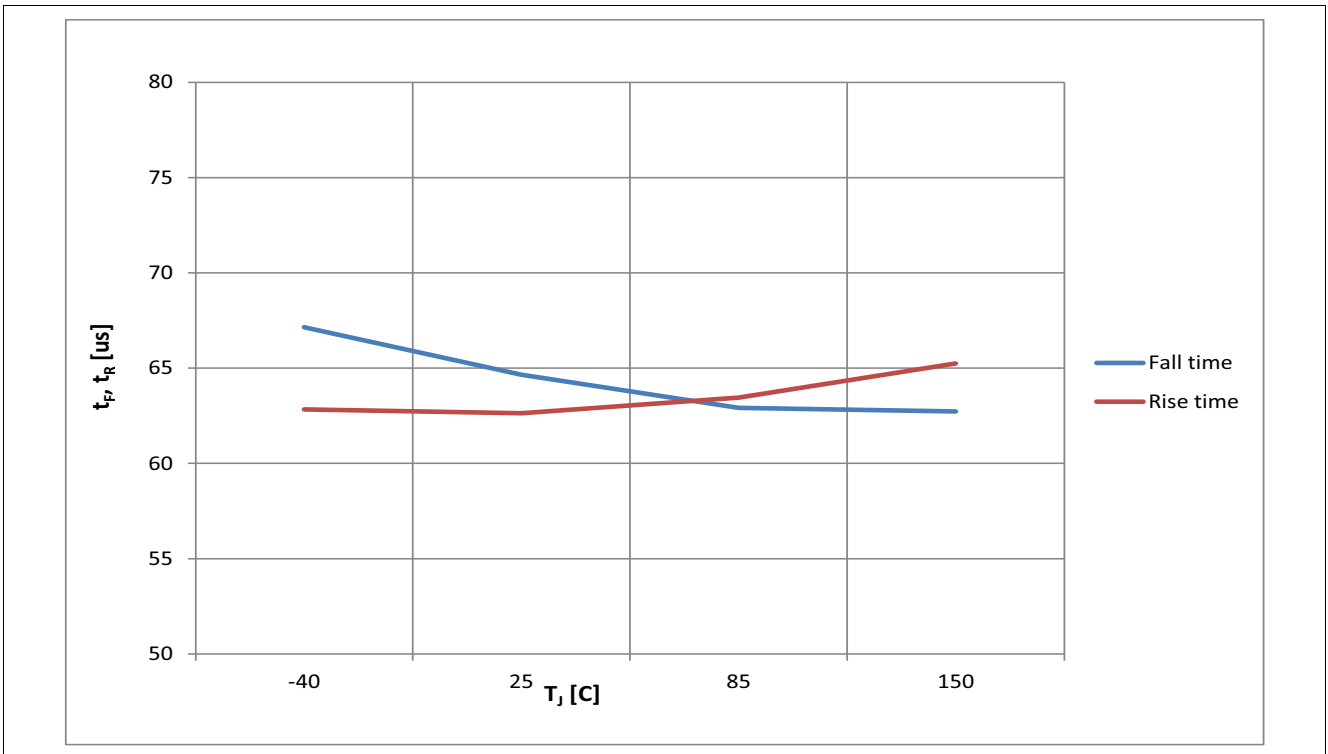


**Figure 33** Typical  $t_{DON}$ ,  $t_{DOFF}$  vs  $I_L$  @  $V_{IN} = 5 V$ ,  $T_J = -40 \dots 150^\circ C$

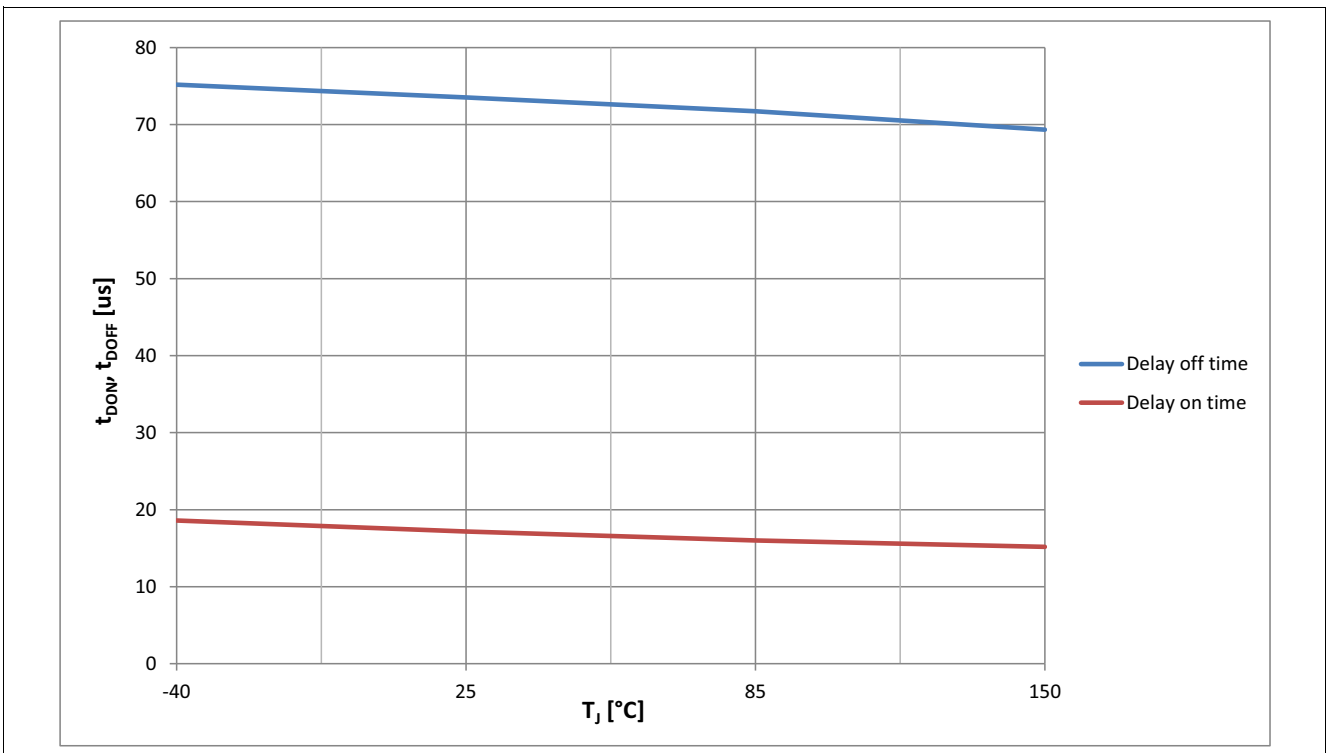


**Figure 34** Typical  $-(\Delta V/\Delta t)_{ON}$ ,  $(\Delta V/\Delta t)_{OFF}$  vs  $I_L$  @  $V_{IN} = 5 V$ ,  $T_J = -40 \dots 150^\circ C$

**Characterization Results**



**Figure 35** Typical  $t_F, t_R$  vs  $T_J$  @  $V_{IN} = 5V$



**Figure 36** Typical  $t_{DON}, t_{DOFF}$  vs  $T_J$  @  $V_{IN} = 5V$

Characterization Results

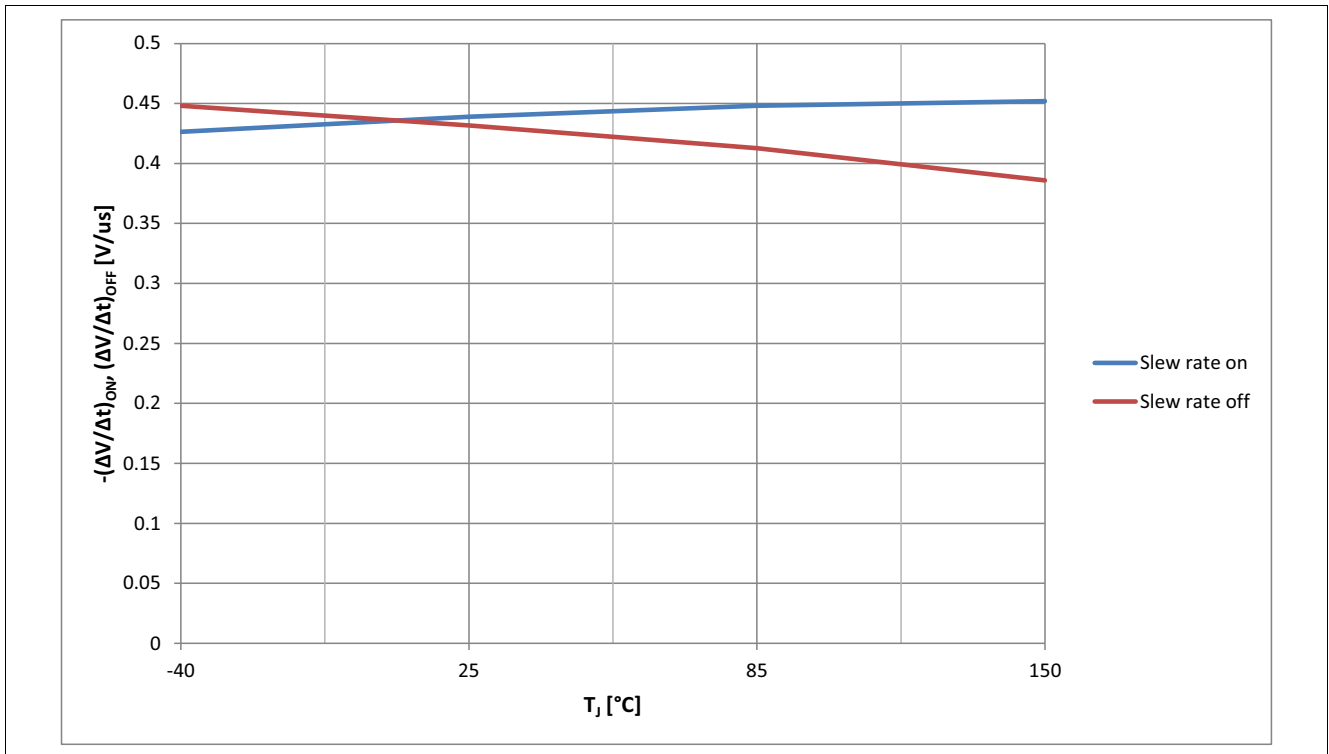
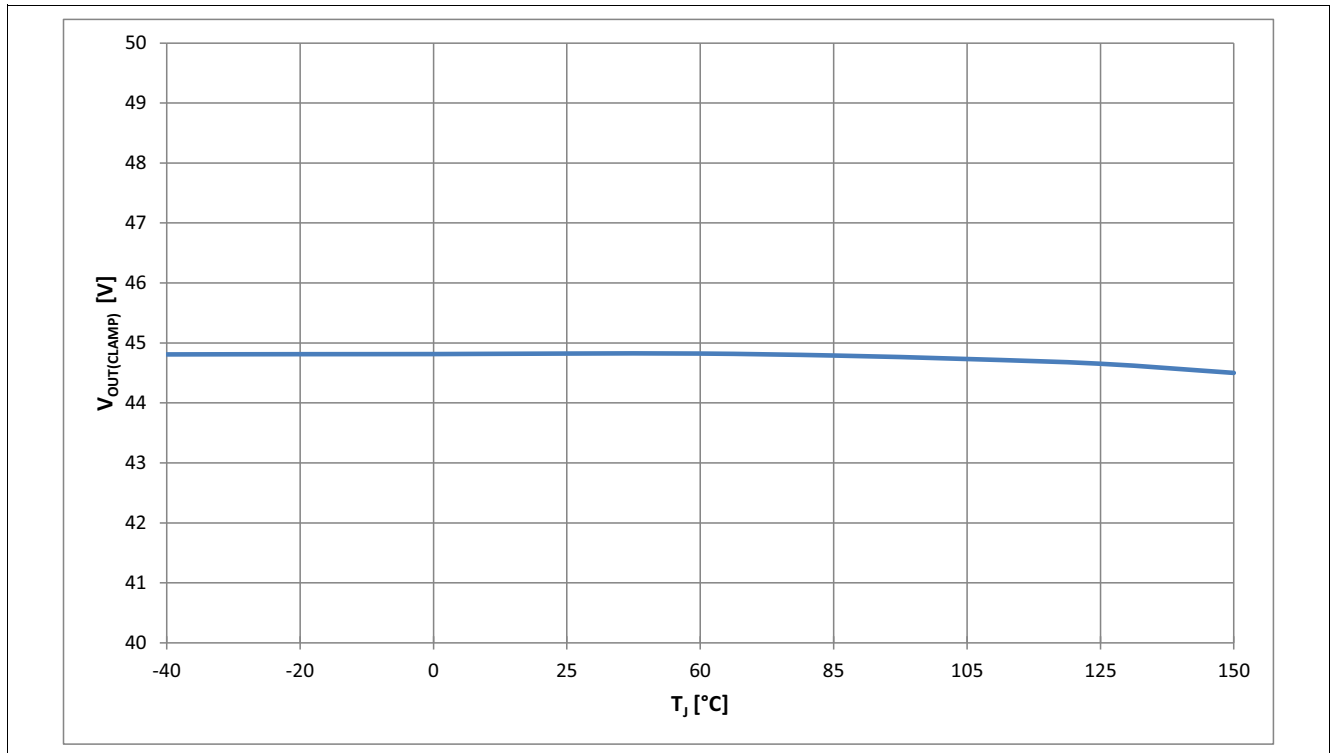


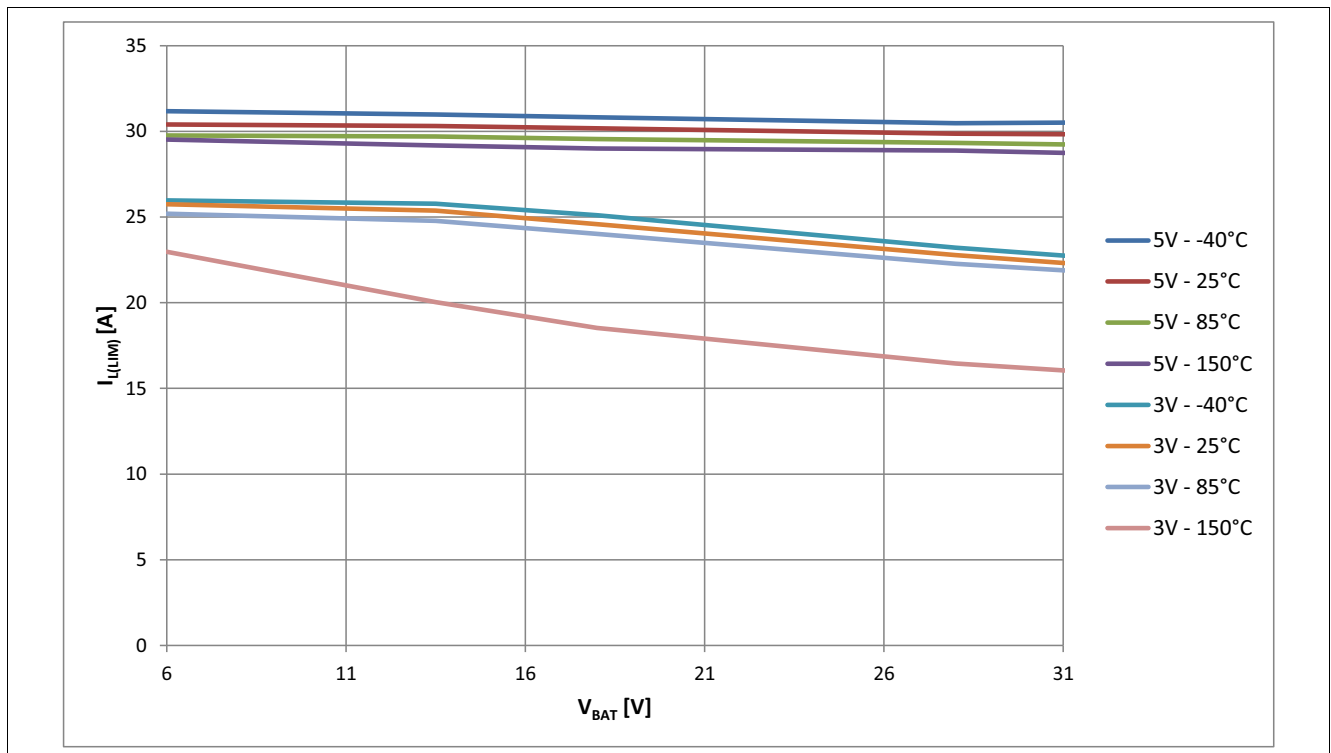
Figure 37 Typical  $(\Delta V/\Delta t)_{ON}$ ,  $(\Delta V/\Delta t)_{OFF}$  vs  $T_J$  @  $V_{IN} = 5 V$

**Characterization Results**

**10.2 Protection**



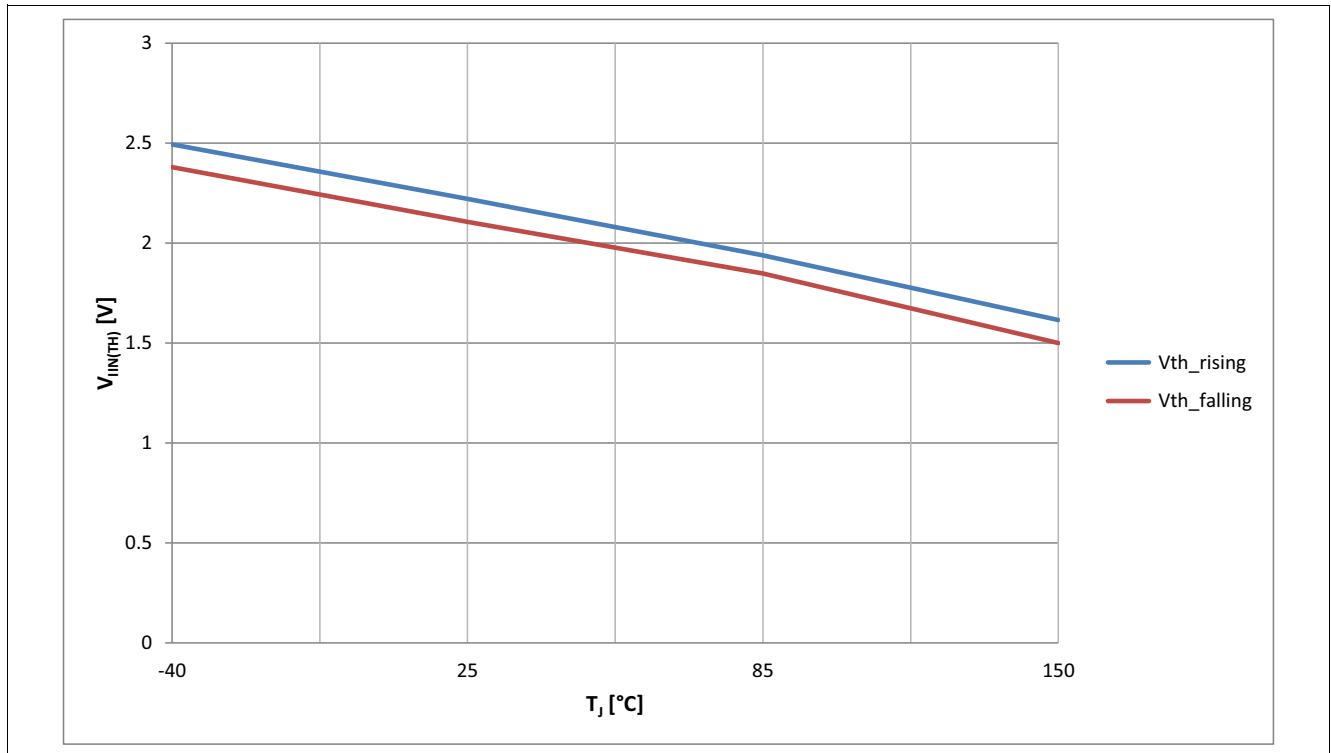
**Figure 38** Typical  $V_{OUT(CLAMP)}$  vs.  $T_J$  @  $I_L = 14$  mA



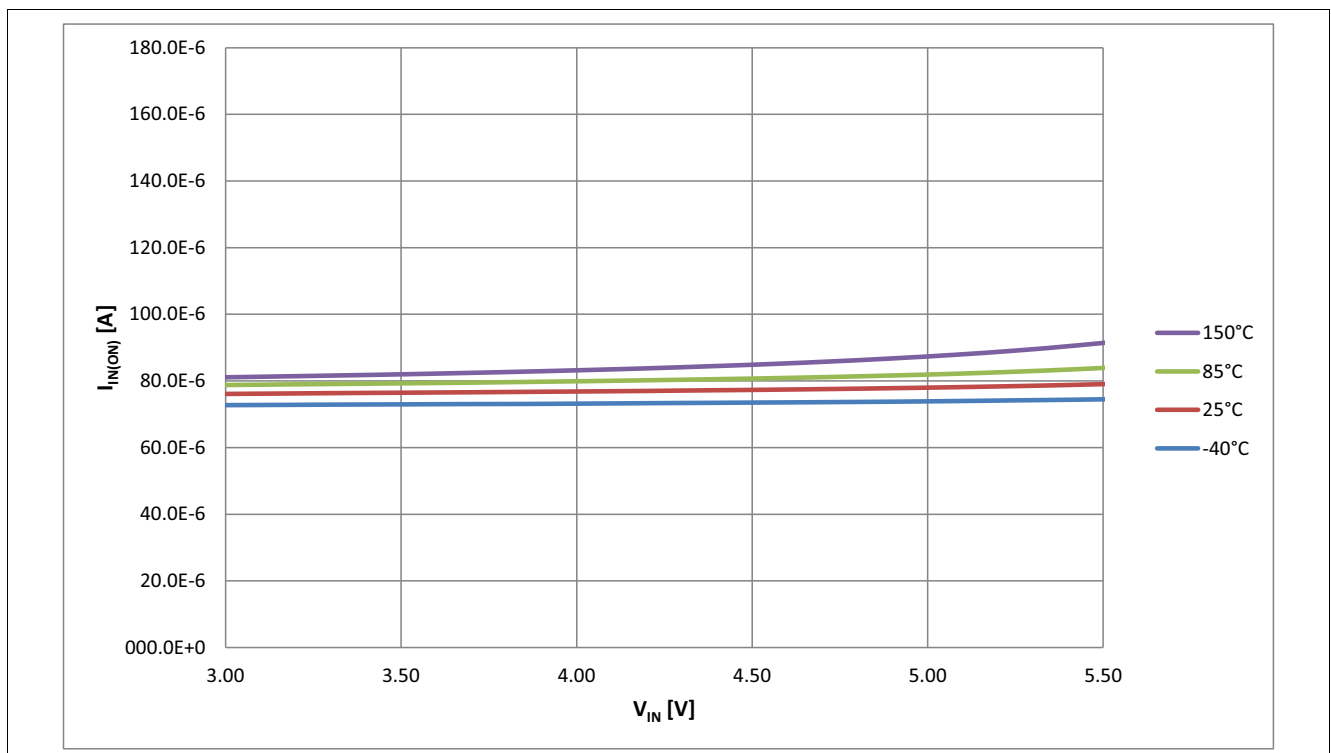
**Figure 39** Typical  $I_{L(LIM)}$  vs.  $V_{BAT}$  @  $T_J = -40 \dots 150^\circ\text{C}$ ,  $V_{IN} = 3$  V and 5 V

**Characterization Results**

**10.3 Input Stage**



**Figure 40** Typical  $V_{IN(TH)}$  vs.  $T_J$  @  $I_L = 1.4$  mA



**Figure 41** Typical  $I_{IN(ON)}$  vs.  $V_{IN}$  @  $T_J = -40 \dots 150^\circ\text{C}$ ,  $I_L = I_{L(NOM)}$

Characterization Results

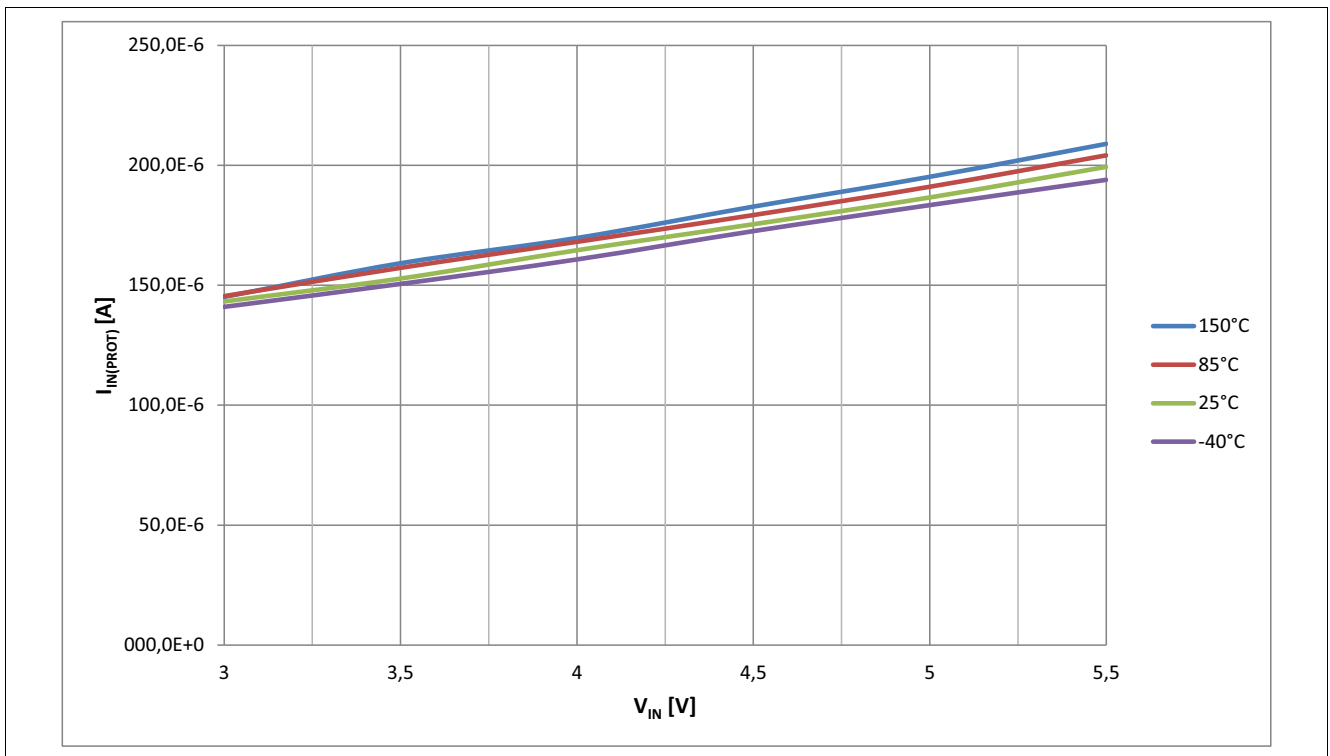
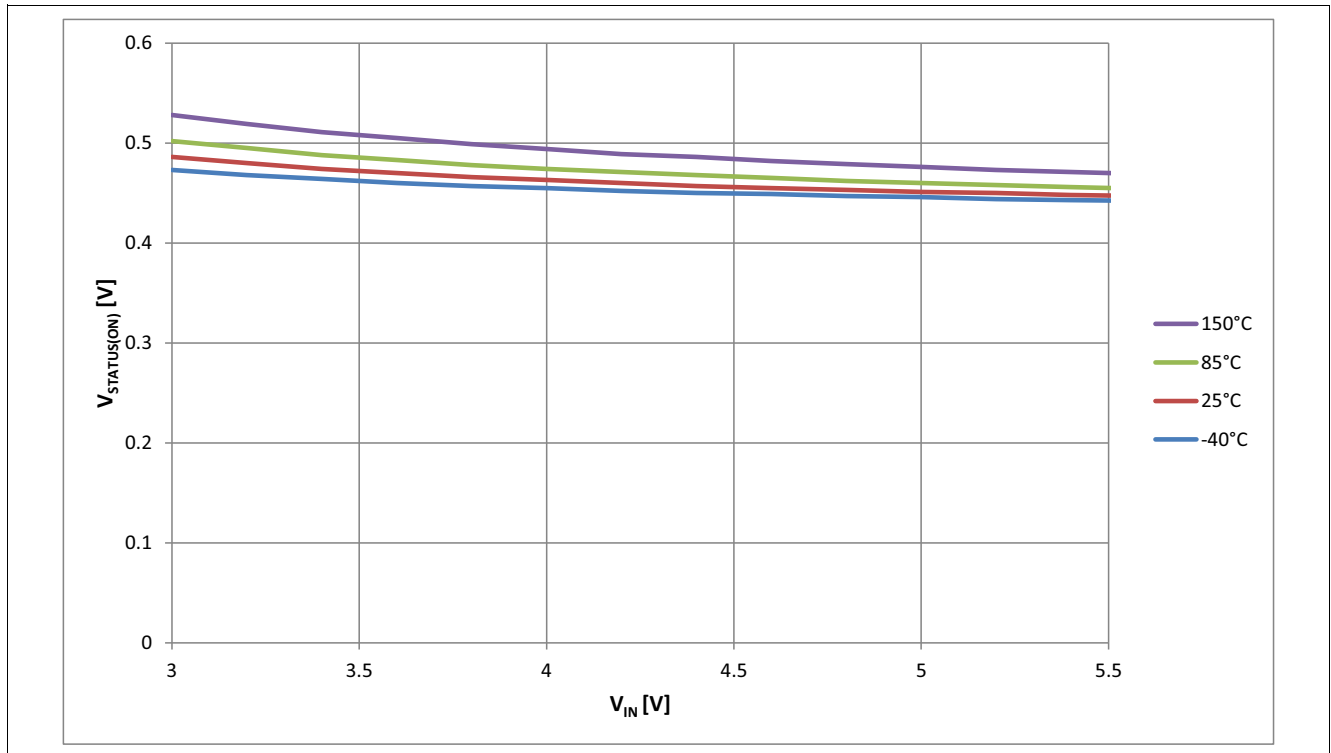


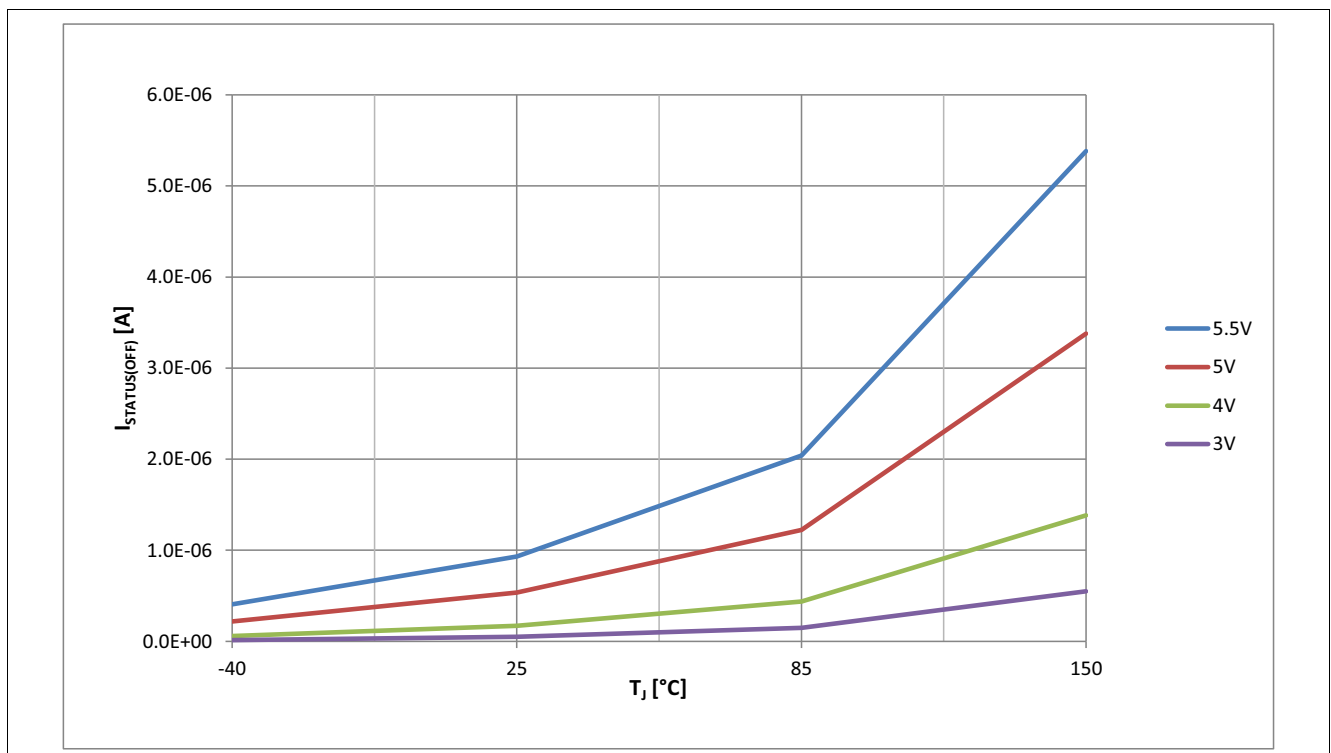
Figure 42 Typical  $I_{IN(PROT)}$  vs.  $V_{IN}$  @  $T_J = -40 \dots 150^\circ\text{C}$ ,  $I_L = I_{L(NOM)}$

**Characterization Results**

**10.4 Diagnosis**



**Figure 43** Typical  $V_{STATUS(ON)}$  vs.  $V_{IN}$  @  $T_J = -40 \dots 150^\circ\text{C}$



**Figure 44** Typical  $I_{STATUS(OFF)}$  vs.  $T_J$  @  $V_{STATUS} = 3 \dots 5.5\text{ V}$ ,  $V_{IN} = 0\text{ V}$



Characterization Results

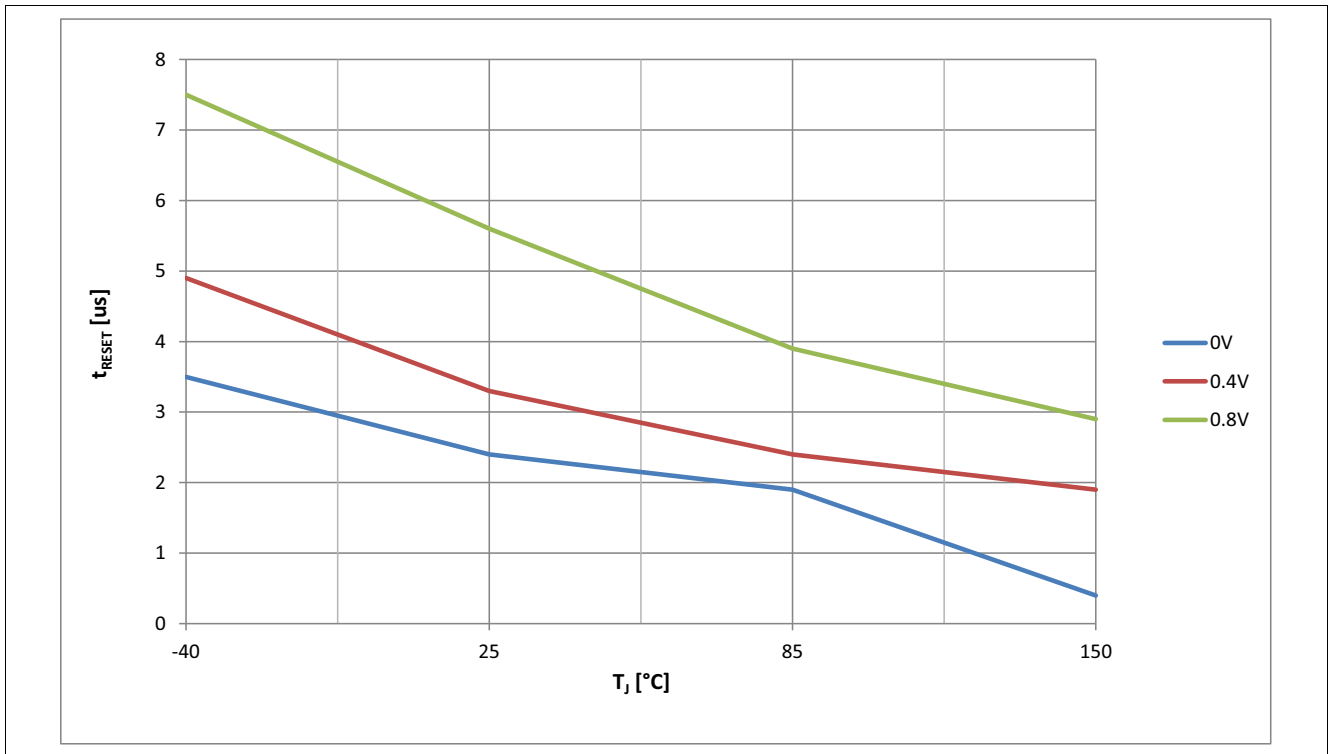


Figure 45 Typical  $t_{\text{RESET}}$  vs  $T_J$  @  $V_{\text{IN}} = 0 \dots 0.8 \text{ V}$

Application Information

## 11 Application Information

Note: The following information is given as a hint for the implementation of the device only and shall not be regarded as a description or warranty of a certain functionality, condition or quality of the device.

### 11.1 Application Diagram

An application example with the BTS3035EJ is shown below.

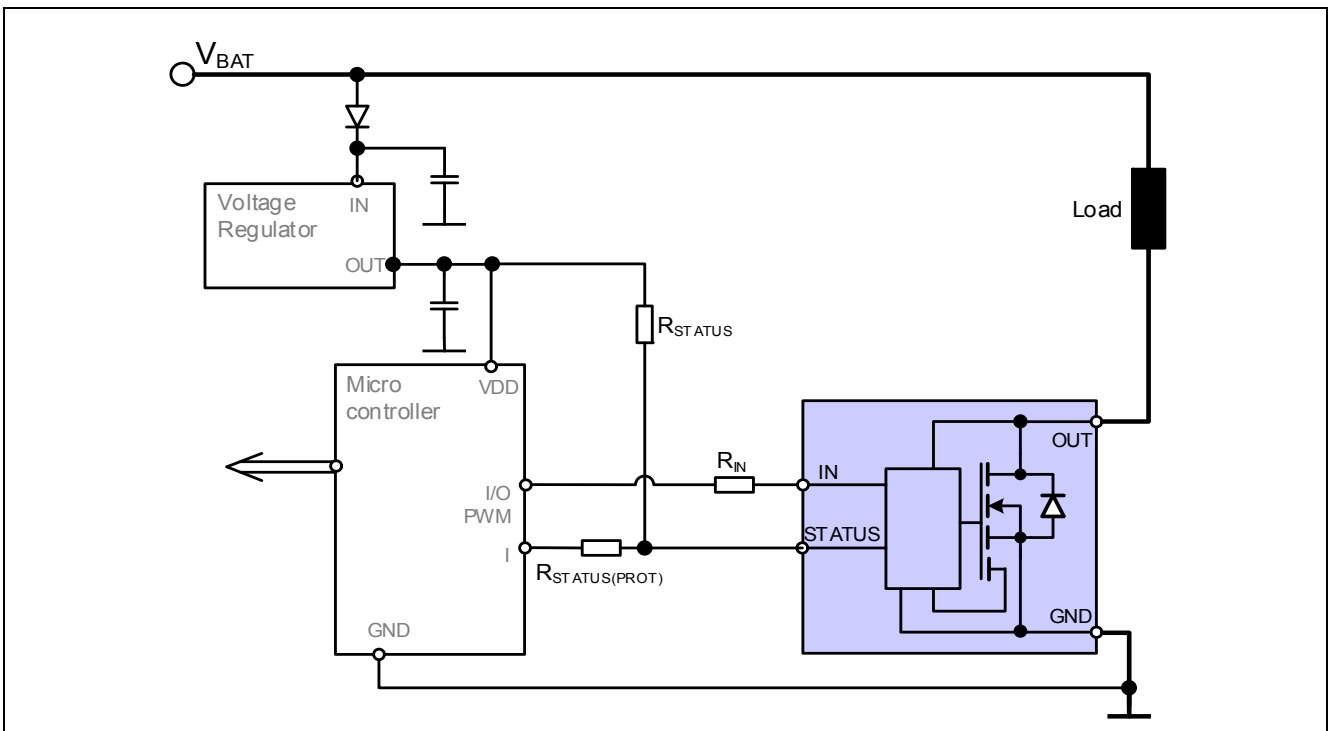


Figure 46 Application example circuitry

Recommended values for  $V_{IN}=5\text{ V}$  and  $V_{DD}=5\text{ V}$ :

$$R_{STATUS}=4.7\text{ k}\Omega$$

$$R_{STATUS(PROT)}=3.3\text{ k}\Omega$$

$$R_{IN}=3.3\text{ k}\Omega$$

Note: This is a very simplified example of an application circuit. The function must be verified in the real application.

Package Outlines

12 Package Outlines

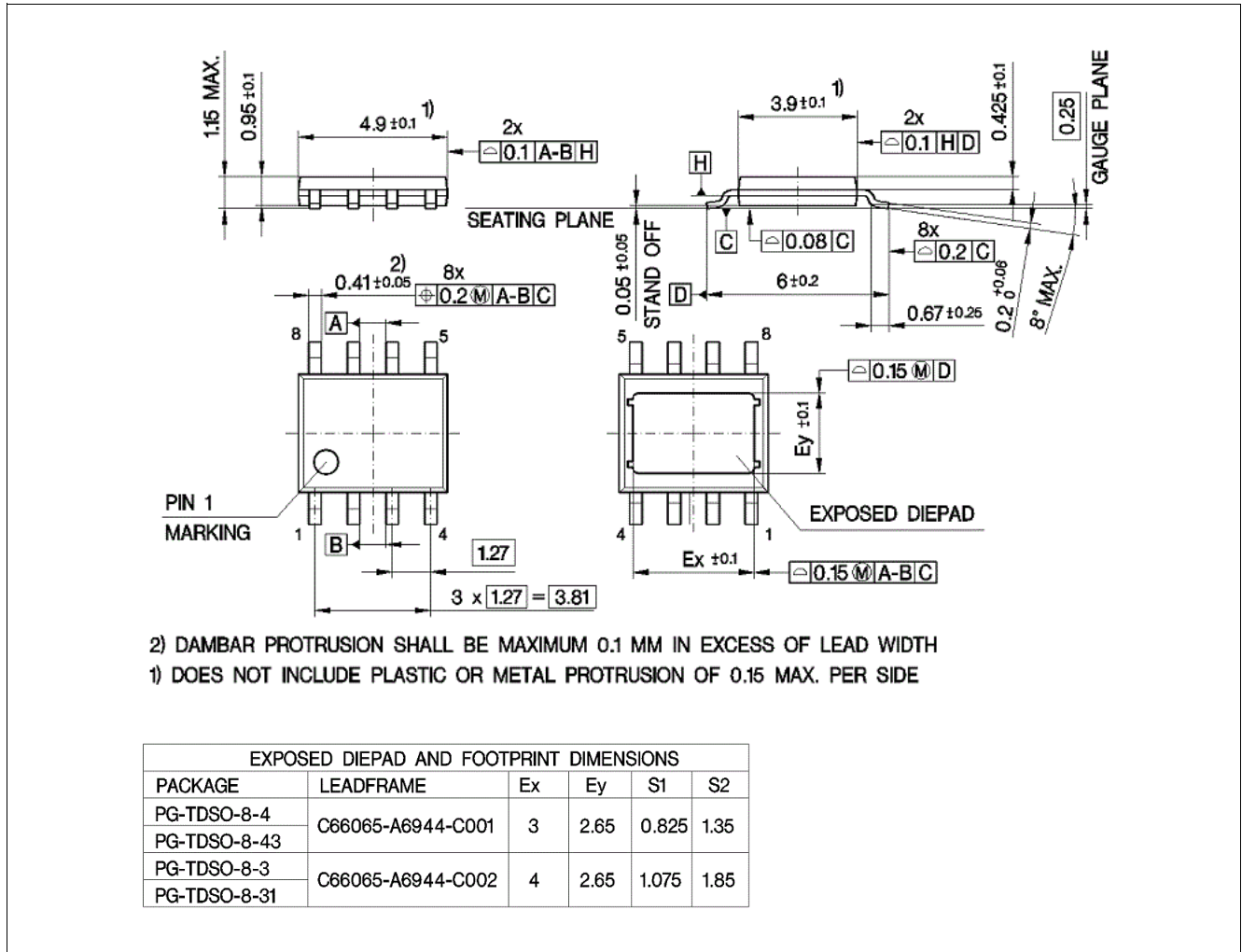


Figure 47 PG-TDSO8-31

Green Product (RoHS compliant)

To meet the world-wide customer requirements for environmentally friendly products and to be compliant with government regulations the device is available as a green product. Green products are RoHS-Compliant (i.e Pb-free finish on leads and suitable for Pb-free soldering according to IPC/JEDEC J-STD-020).

For further information on alternative packages, please visit our website:  
<http://www.infineon.com/packages>.

Dimensions in mm

**Revision History**

**13 Revision History**

| <b>Version</b> | <b>Date</b> | <b>Changes</b>     |
|----------------|-------------|--------------------|
| Rev. 1.0       | 2016-09-12  | Datasheet released |

#### Trademarks of Infineon Technologies AG

$\mu$ HVIC™,  $\mu$ IPM™,  $\mu$ PFC™, AU-ConvertIR™, AURIX™, C166™, CanPAK™, CIPOS™, CIPURSE™, CoolDP™, CoolGaN™, COOLiR™, CoolMOS™, CoolSET™, CoolSiC™, DAVE™, DI-POL™, DirectFET™, DrBlade™, EasyPIM™, EconoBRIDGE™, EconoDUAL™, EconoPACK™, EconoPIM™, EiceDRIVER™, eupec™, FCOS™, GaNpowIR™, HEXFET™, HITFET™, HybridPACK™, iMOTION™, IRAM™, ISOFACE™, IsoPACK™, LEDriviR™, LITIX™, MIPAQ™, ModSTACK™, my-d™, NovalithIC™, OPTIGA™, OptiMOS™, ORIGA™, PowIRaudio™, PowIRStage™, PrimePACK™, PrimeSTACK™, PROFET™, PRO-SIL™, RASIC™, REAL3™, SmartLEWIS™, SOLID FLASH™, SPOC™, StrongIRFET™, SupIRBuck™, TEMPFET™, TRENCHSTOP™, TriCore™, UHVIC™, XHP™, XMC™.

Trademarks updated November 2015

#### Other Trademarks

All referenced product or service names and trademarks are the property of their respective owners.

**Edition 2016-09-12**

**Published by**

**Infineon Technologies AG**

**81726 Munich, Germany**

**© 2016 Infineon Technologies AG.**

**All Rights Reserved.**

**Do you have a question about any aspect of this document?**

**Email: [erratum@infineon.com](mailto:erratum@infineon.com)**

#### IMPORTANT NOTICE

The information given in this document shall in no event be regarded as a guarantee of conditions or characteristics ("Beschaffheitsgarantie").

With respect to any examples, hints or any typical values stated herein and/or any information regarding the application of the product, Infineon Technologies hereby disclaims any and all warranties and liabilities of any kind, including without limitation warranties of non-infringement of intellectual property rights of any third party.

In addition, any information given in this document is subject to customer's compliance with its obligations stated in this document and any applicable legal requirements, norms and standards concerning customer's products and any use of the product of Infineon Technologies in customer's applications.

The data contained in this document is exclusively intended for technically trained staff. It is the responsibility of customer's technical departments to evaluate the suitability of the product for the intended application and the completeness of the product information given in this document with respect to such application.

For further information on technology, delivery terms and conditions and prices, please contact the nearest Infineon Technologies Office ([www.infineon.com](http://www.infineon.com)).

#### WARNINGS

Due to technical requirements products may contain dangerous substances. For information on the types in question please contact your nearest Infineon Technologies office.

Except as otherwise explicitly approved by Infineon Technologies in a written document signed by authorized representatives of Infineon Technologies, Infineon Technologies' products may not be used in any applications where a failure of the product or any consequences of the use thereof can reasonably be expected to result in personal injury.