

Typical unit

**FEATURES**

- Settable output voltage from 0.7 to 4.0V
- Wide input voltage range 4.5 to 15V
- Up to 30A of output current
- Quick response to load change
- Ultra small surface mount package 14.0 x 11.0 x 8.3mm
- Peak efficiency of 97.6% max.
- Outstanding thermal derating performance
- Over current protection
- On/Off control (Positive logic)
- Power Good signal
- High Reliability / Heat Shock Testing 700cycle (-40 to +125degC)

**PRODUCT OVERVIEW**

The **MYSGK4R030ERSR** is miniature MonoBK™ called “Mono Block”, non-isolated Point-of-Load (PoL) DC-DC power converter for embedded applications. The small form factor measures only 14.0 x 11.0 x 8.3mm. Applications include powering FPGA/CPU's, datacom/telecom systems, Distributed Bus Architectures (DBA), programmable logic and mixed voltage systems.

The converter have input voltage range of 4.5 to 15.0V and a maximum output current of 30A. Based on a fixed frequency synchronous buck converter switching topology, this high power conversion efficient PoL module features settable output voltage 0.7 to 4.0V, On/Off control and Power Good signal output.

These converters also include under voltage lock out (UVLO), output short circuit protection and over-current protection.

**SIMPLIFIED APPLICATION**

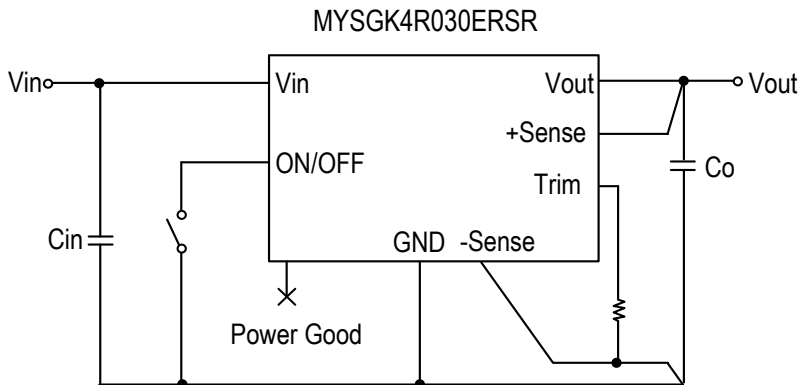

MYSGK4R030ERSR

Cin : 22uF/25V x 2pcs

Co : 100uF/6.3V x 8pcs

(Typical topology is shown. Murata recommends an external input fuse.)

**PERFORMANCE SPECIFICATIONS SUMMARY AND ORDERING GUIDE (Including series products)**

PART NUMBER	OUTPUT						INPUT				Efficiency (%)	ON/OFF	Package (mm)
	Vout (V)	Iout (A,max.)	Power (W)	R/N typ. (% of Vout)	Regulation(max.)		Vin typ. (V)	Range (V)	Iin no load (mA)	Iin full load (A)			
					Line(%)	Load(%)							
MYSGK4R030ERSR	0.7-4.0 (typ.:4.0V)	30	120	0.77	±1.0	±1.0	12	4.5 - 15	95.3	10.59	94.4	Yes (Positive)	14.0 x 11.0 x 8.3
MYSGK4R030ERSRD	0.7-4.0 (typ.:4.0V)	30	120	0.77	±1.0	±1.0	12	4.5 - 15	95.3	10.59	94.4	Yes (Positive)	14.0 x 11.0 x 8.3

1.All specifications are at typical line voltage, Vout = 4.0V and full load, +25degC unless otherwise noted. Output capacitors are 100uF x 8 ceramic. Input capacitors is 22uF x 2 ceramic and plenty electrolytic capacitors. See detailed specifications. Input and Output capacitors are necessary for our test equipment.  
2.Use adequate ground plane and copper thickness adjacent to the converter.

**PART NUMBER STRUCTURE**

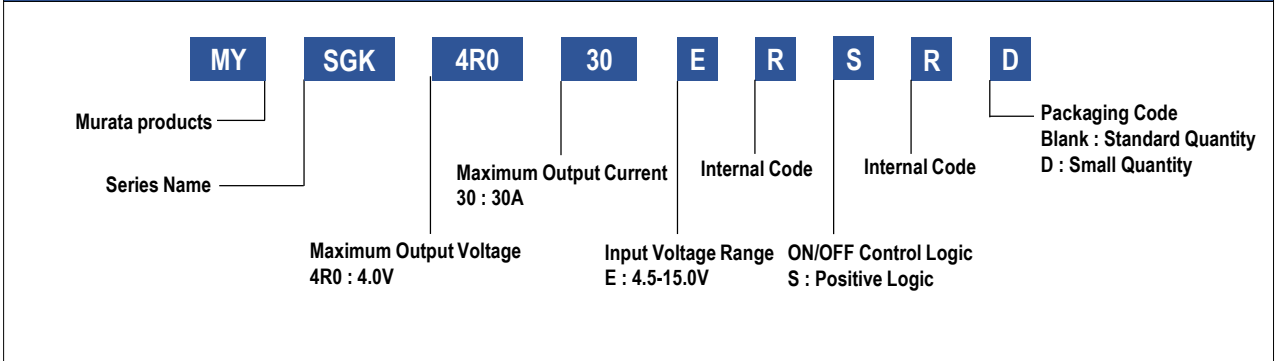

**Product Marking**

Because of the small size of these products, the product marking contains a character-reduced code to indicate the model number and manufacturing date code. Not all items on the marking are always used. Please note that the marking differs from the product photograph. Here is the layout of the Marking.

Part Number	Product Code
MYSGK4R030ERSR	E4
MYSGK4R030ERSRD	E4

**Layout (reference)**

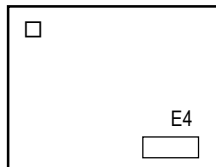

**Codes (reference)**

- Internal Manufacturing code 1
- E4 Product code (Please see product code table beside)
- Internal Manufacturing code 2

**FUNCTIONAL SPECIFICATIONS OF MYSGK4R030ERSR (Note 1)**

ABSOLUTE MAXIMUM RATINGS	Conditions	Minimum	Typical	Maximum	Units
Input Voltage		-0.3		16	V
ON/OFF Pin	Power on, referred to -Vin	-0.3		7.5	V
PGOOD/Trim Pins	Power on, referred to -Vin		Source ONLY		
Vout		-0.3		4.4	V
Output Current	Current-limited, no damage, short-circuit protected	0		30	A
Storage Temperature Range	Vin = Zero (no power)	-40		125	degC
Absolute maximums are stress ratings. Exposure of devices to greater than any of these conditions may adversely affect long-term reliability. Proper operation under conditions other than those listed in the Performance/Functional Specifications Table is not implied or recommended.					
INPUT	Conditions	Minimum	Typical	Maximum	Units
Operating Voltage Range	Lower limit of Vin depends on Vout. Refer to Voltage Range Graph on page 18	4.5	12	15	V
Start-up Threshold	Rising input voltage, Vout = 1.8V		4.25		V
	Rising input voltage, Vout = 4.0V		4.67		V
Under Voltage Shutdown	Note 12		4.05		V
Internal Filter Type			Capacitive		
Input Current					
Full Load Conditions	Vin = 12.0V, Vout = 4.0V, Iout = 30A		10.59		A
Low Line	Vin = 5.2V, Vout = 4.0V, Iout = 30A		24.48		A
No Load Current	Iout = 0A, unit = ON		95.3		mA
Shut-Down Mode Input Current			2		mA
GENERAL and SAFETY	Conditions	Minimum	Typical	Maximum	Units
Efficiency	Vin = 12.0V, Vout = 4.0V, Iout = 30A		94.4		%
	Vin = 12.0V, Vout = 1.8V, Iout = 30A		88.3		
	Vin = 5.0V, Vout = 1.8V, Iout = 30A		89.6		
Safety	Certified to UL-60950-1, CSA-C22.2 No. 60950-1, IEC/EN60950-1, 2nd edition(pending)		Pending		
Calculated MTBF (Note 3)	+40degC, Vin = 12.0V, Vout = 4.0V, Iout = 50%		8,300,000		hours
DYNAMIC CHARACTERISTICS	Conditions	Minimum	Typical	Maximum	Units
Fixed Switching Frequency			425		kHz
Startup Time (Vin ON)	Vout = 4.0V (Vin On to 90% of Vout)		3.9		ms
Startup Time (Remote ON)	Vout = 4.0V (Remote On to 90% of Vout)		2.9		ms
Dynamic Load Response	(50-100% load step, di/dt)		0.5		A/us
Dynamic Load Peak Deviation	Vout = 1.8V (50-100% load step, di/dt), Note14		±3.0%		% of Vout
	Vout = 4.0V (50-100% load step, di/dt), Note14		±3.0%		% of Vout
FUNCTIONS	Conditions	Minimum	Typical	Maximum	Units
Remote On/Off Control (Note 4)					
Logic					
ON State Range	ON = +1.8V min. to +5.0V max. or left open	1.8		5.0	V
OFF Stage Range	OFF = -0.1V to +0.5V max.	-0.1		0.5	V
Control Current	Open collector/drain			-	mA
Power-Good Output (Pulled up to 5.0Vreg(typ.) internally)					
PGood TRUE (HI)			(95% of target Vout) < Vout < (105% of target Vout)		
PGood FALSE (LO)			Out of above range		

### FUNCTIONAL SPECIFICATIONS OF MYSKG4R030ERSR (Note 1)

OUTPUT	Conditions	Minimum	Typical	Maximum	Units
Total Output Power	See Derating	0		120	W
Voltage					
Output Voltage Range	Note 10	0.7		4.0	V
Minimum Loading			Note		
Accuracy (50% load, untrimmed)	Vin = 12.0V, Vout = 4.0V, Cout=800uF, Ta = 25degC		± 1		% of Vout
	Vin = 12.0V, Vout = 1.8V, Cout=800uF, Ta = 25degC		± 1		% of Vout
	Vin = 5.0V, Vout = 1.8V, Cout=800uF, Ta = 25degC		± 1		% of Vout
Over Voltage Protection	Note 13		120%		% of Vout
Under Voltage Protection			68%		% of Vout
Current					
Output Current Range	Note 2	0		30	A
Current Limit Inception	After warmup		50		A
Short Circuit					
Short Circuit Duration (remove short for recovery)	Output shorted to ground, no damage		Continuous		
Short Circuit Protection Method	Note 5		Hiccup		
Pre-bias Start-up		Converter will start up if the external output voltage is less than set Vout.			
Regulation (Note 8)					
Line Regulation	Vin = min. to max.			± 1	% of Vout
Load Regulation	Iout = min. to max.			± 1	% of Vout
Ripple and Noise (20MHz bandwidth)	Note 6		1		% of Vout
External Output Capacitance Range (Note 11)		800		6000	uF
<b>MECHANICAL(Common)</b>					
	<b>Conditions</b>	<b>Minimum</b>	<b>Typical</b>	<b>Maximum</b>	<b>Units</b>
Mechanical Dimension	L x W x H	14.0(typ.) x 11.0(typ.) x 8.3(max.)			mm
Weight			4.21		grams
<b>ENVIRONMENTAL(Common)</b>					
	<b>Conditions</b>	<b>Minimum</b>	<b>Typical</b>	<b>Maximum</b>	<b>Units</b>
Operating Ambient Temperature Range	With Derating (Note 2, 7)	-40		105	degC
Storage Temperature Range	Vin = Zero (no power)	-40		125	degC
Thermal Protection/Shutdown	Measured in module (Note 9)		165		degC
Moisture Sensitivity Level			3		

### Specification Notes

(1) Specifications are typical at +25degC, Vin=+12.0V(MYSKG4R030ERSR), Vout=typical (+4.0V), full load, external caps and natural convection unless otherwise indicated. All models are tested and specified with external 100uF x 8 ceramic output capacitors, 22uF x 2 ceramic and plenty electrolytic external input capacitors. All capacitors are low ESR types. These capacitors are necessary to accommodate our test equipment and may not be required to achieve specified performance in your applications. However, Murata recommends installation of these capacitors.  
 (2) Note that Maximum Power Derating curves indicate an average current at typical input voltage. At higher temperatures and/or no airflow, the converter will tolerate brief full current outputs if the total RMS current over time does not exceed the Derating curve.  
 (3) Mean Time Between Failure is calculated using the Telecordia SR-332 method, +40degC, half output load, natural air convection.  
 (4) The On/Off Control Input should use either a switch or an open collector/open drain transistor referenced to GND. A logic gate may also be used by applying appropriate external voltages which do not exceed +Vin.  
 (5) "Hiccup" overcurrent operation repeatedly attempts to restart the converter with a brief, full-current output. If the overcurrent condition still exists, the restart current will be removed and then tried again. This short current pulse prevents overheating and damaging the converter. Once the fault is removed, the converter immediately recovers normal operation.

(6) Output noise may be further reduced by adding an external filter. At zero output current, the output may contain low frequency components which exceed the ripple specification. The output may be operated indefinitely with no load.  
 (7) All models are fully operational and meet published specifications, including "cold start" at -40degC.  
 (8) Regulation specifications describe the deviation as the line input voltage or output load current is varied from a midpoint value to either extreme.  
 (9) Thermal Protection/Shutdown temperature is measured with the sensor in the converter.  
 (10) Do not exceed maximum power specifications when adjusting the output trim.  
 (11) The maximum output capacitive loads depend on the Equivalent Series Resistance (ESR) of the external output capacitor and, to a lesser extent, the distance and series impedance to the load. Larger caps will reduce output noise but may change the transient response. Newer ceramic caps with very low ESR may require lower capacitor values to avoid instability. Thoroughly test your capacitors in the application.  
 (12) Do not allow the input voltage to degrade lower than the input under voltage shutdown voltage at all times. Otherwise, you risk having the converter turn off. The under voltage shutdown is not latching and will attempt to recover when the input is brought back into normal operating range.  
 (13) The outputs are intended to sink appreciable reverse current.  
 (14) About di/dt condition, please refer to the table described later.

Internal Circuit Diagrams

ON/OFF internal circuit diagram and using guide

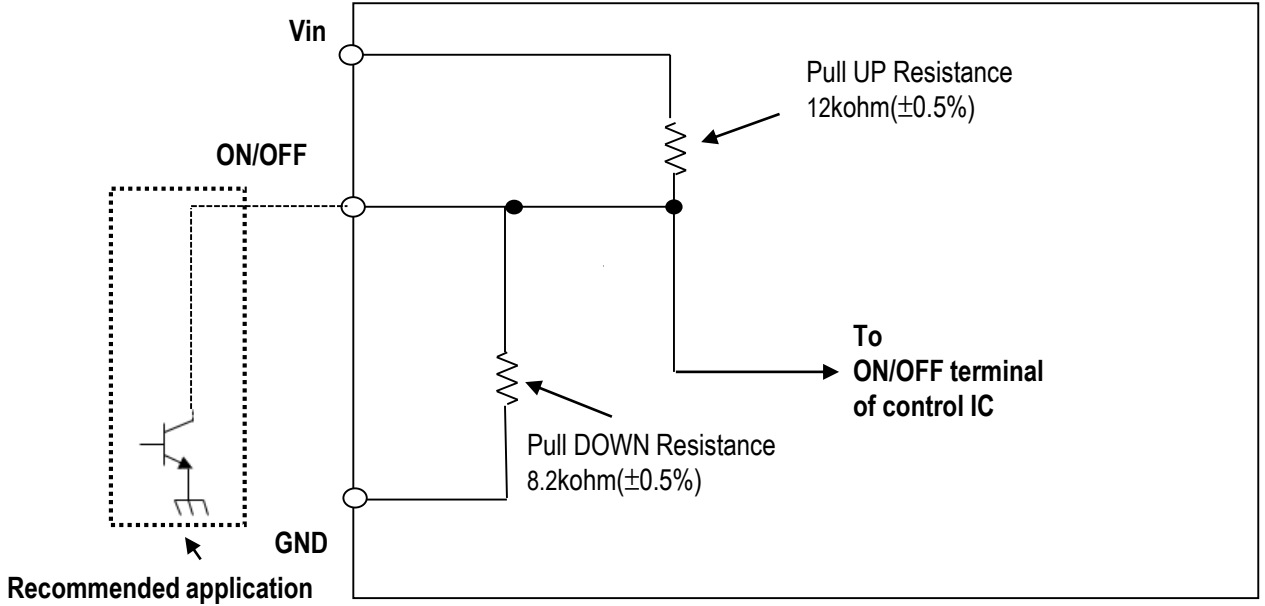

Power Good(P.G) internal circuit diagram and using guide

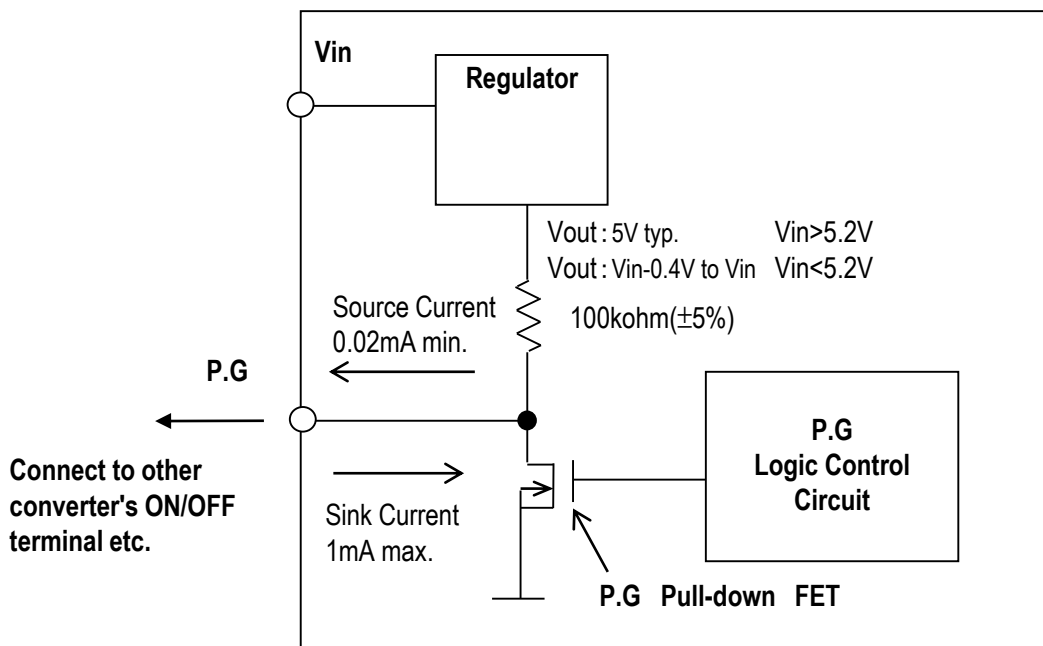

**PERFORMANCE DATA AND OSCILLOGRAMS OF MYSGK4R030ERSR**

Efficiency vs. Line Voltage and Load Current @ +25degC. (Vout = 0.7V)

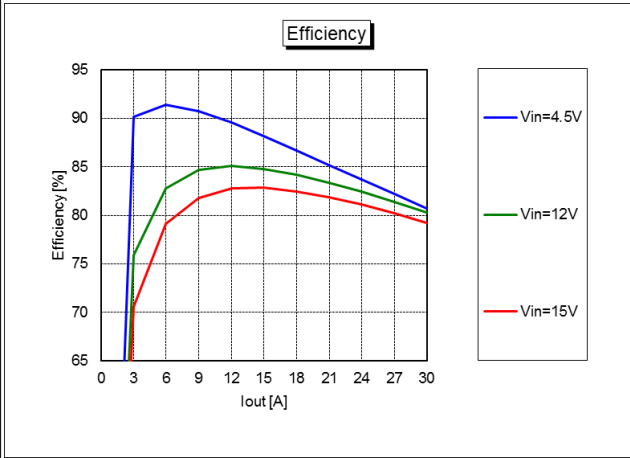

Vout vs. Line Voltage and Load Current @ +25degC. (Vout = 0.7V)

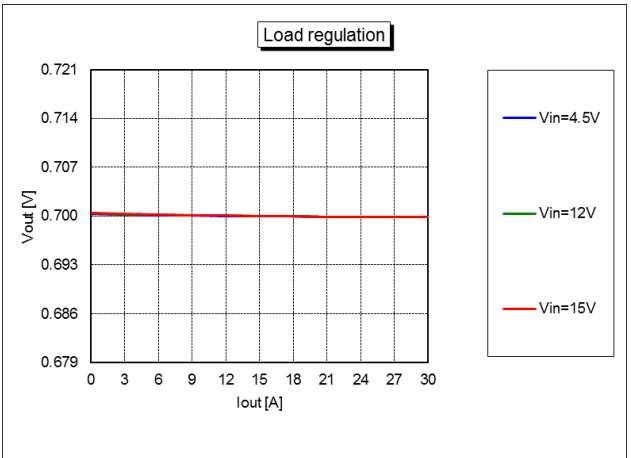

On/Off Enable Delay (Vin=12.0V, Vout=0.7V, Iout=30A, Cload=800uF)  
Trace1=Enable, Trace2=Vout, Trace3=P.G

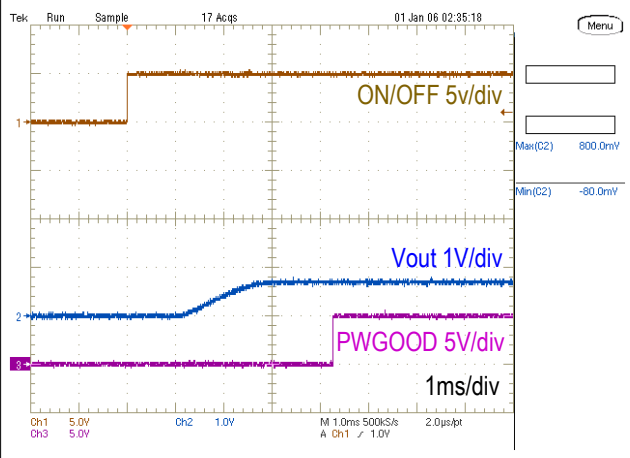

Output Ripple and Noise (Vin=12.0V, Vout=0.7V, Iout=30A, Cload=800uF, Scope BW=20MHz)

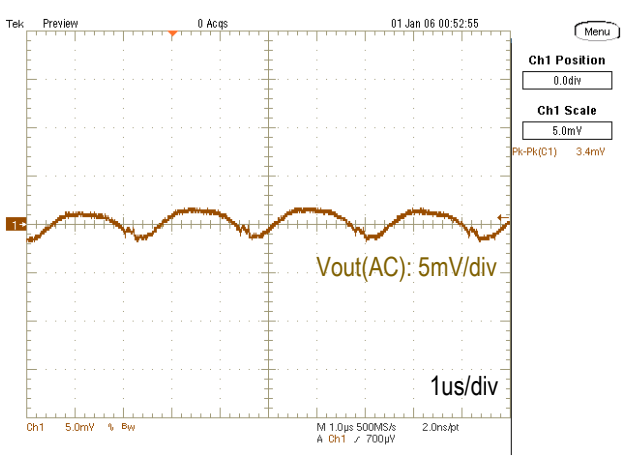

Step Load Transient Response (Vin=12.0V, Vout=0.7V, Cload=800uF, Iout=15A to 30A, 1.0A/us) Trace 3=Vout, 50mV/div, Trace 4=Iout, 20A/div.

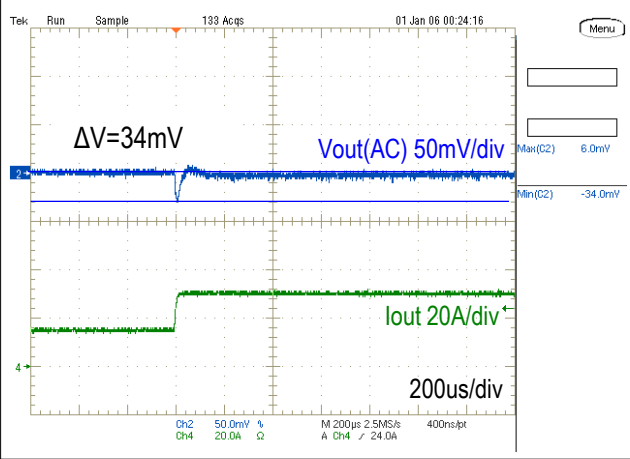

Step Load Transient Response (Vin=12.0V, Vout=0.7V, Cload=800uF, Iout=30 to 15A, 1.0A/us) Trace 3=Vout, 50mV/div, Trace 4=Iout, 20A/div.

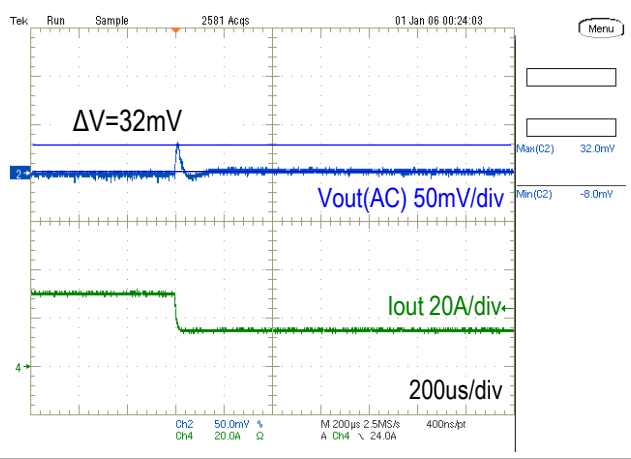

**PERFORMANCE DATA AND OSCILLOGRAMS OF MYSGK4R030ERSR**

Efficiency vs. Line Voltage and Load Current @ +25degC. (Vout = 1.8V)

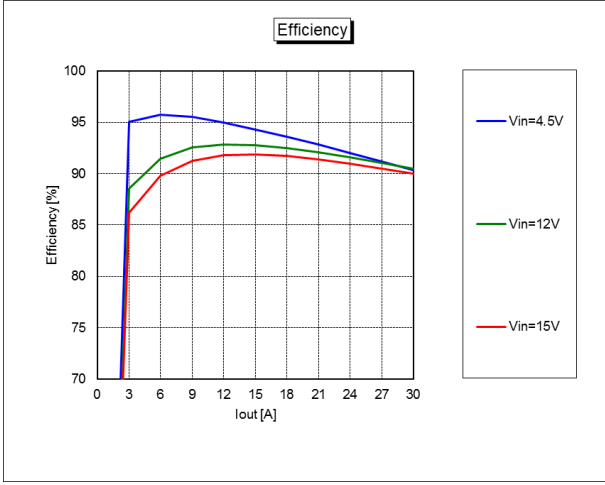

Vout vs. Line Voltage and Load Current @ +25degC. (Vout = 1.8V)

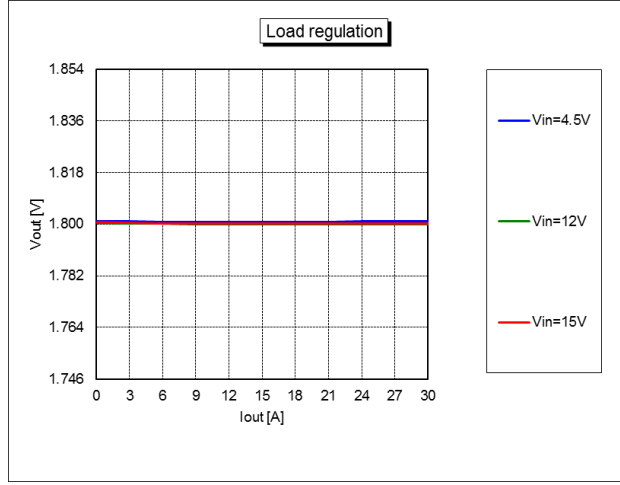

On/Off Enable Delay (Vin=12.0V, Vout=1.8V, Iout=30A, Cload=800uF)  
Trace1=Enable, Trace2=Vout, Trace3=P.G

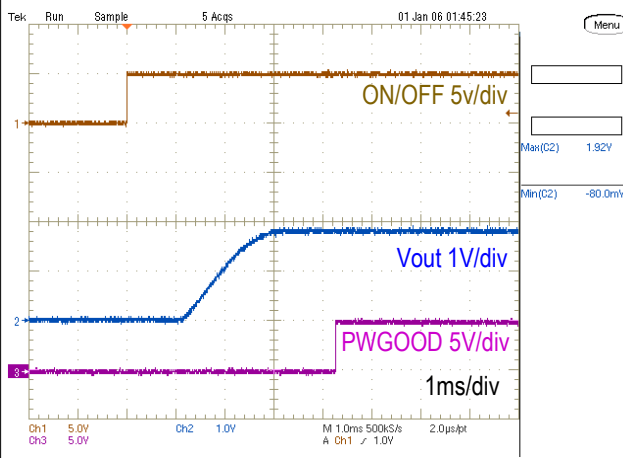

Output Ripple and Noise (Vin=12.0V, Vout=1.8V, Iout=30A, Cload=800uF, Scope BW=20MHz)

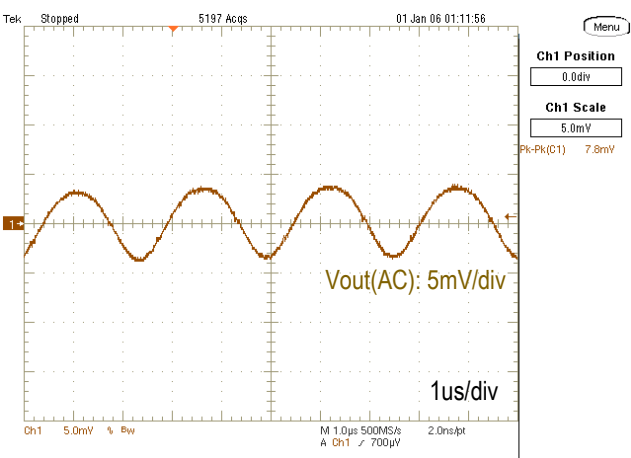

Step Load Transient Response (Vin=12.0V, Vout=1.8V, Cload=800uF, Iout=15A to 30A, 1.0A/us) Trace 3=Vout, 50mV/div, Trace 4=Iout, 20A/div.

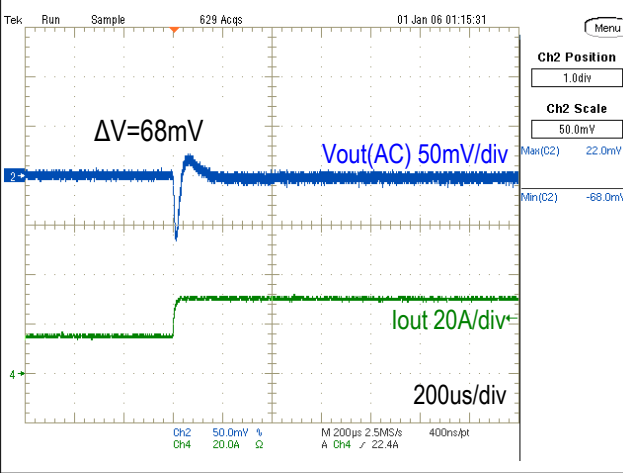

Step Load Transient Response (Vin=12.0V, Vout=1.8V, Cload=800uF, Iout=30 to 15A, 1.0A/us) Trace 3=Vout, 50mV/div, Trace 4=Iout, 20A/div.

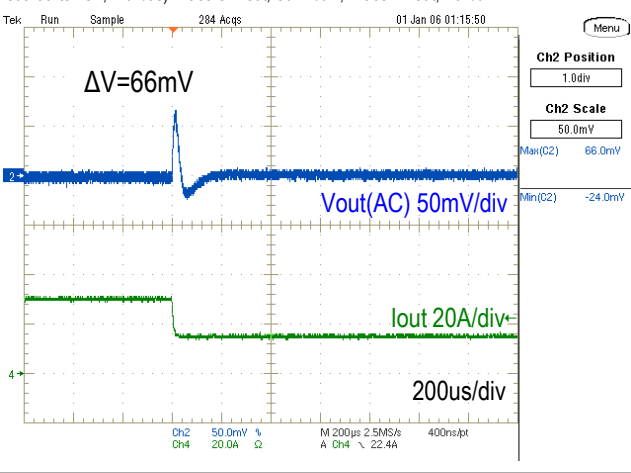

**PERFORMANCE DATA AND OSCILLOGRAMS OF MYSGK4R030ERSR**

Efficiency vs. Line Voltage and Load Current @ +25degC. (Vout = 2.5V)

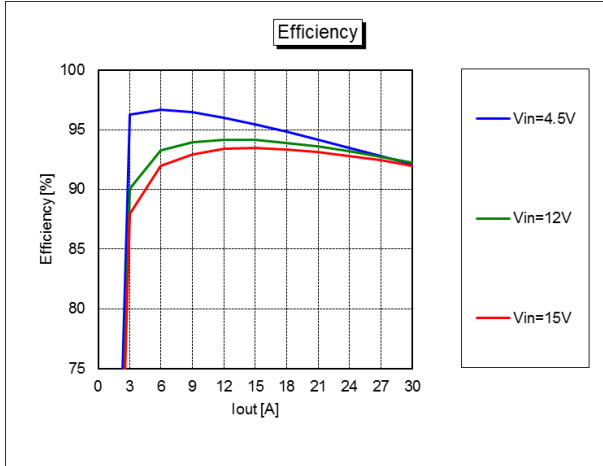

Vout vs. Line Voltage and Load Current @ +25degC. (Vout = 2.5V)

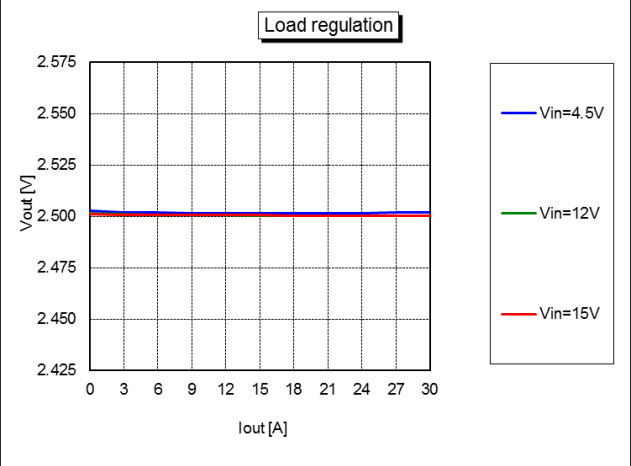

On/Off Enable Delay (Vin=12.0V, Vout=2.5V, Iout=30A, Cload=800uF)  
Trace1=Enable, Trace2=Vout, Trace3=P.G

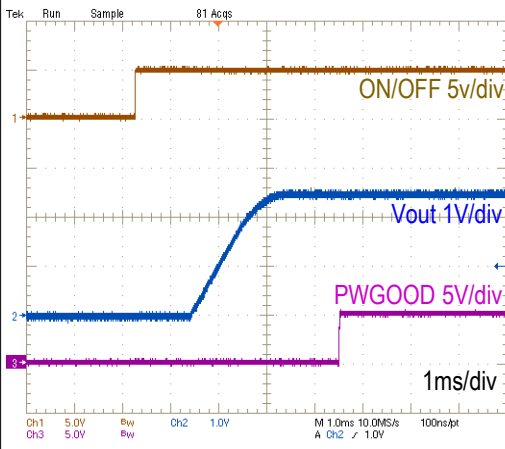

Output Ripple and Noise (Vin=12.0V, Vout=2.5V, Iout=30A, Cload=800uF, Scope BW=20MHz)

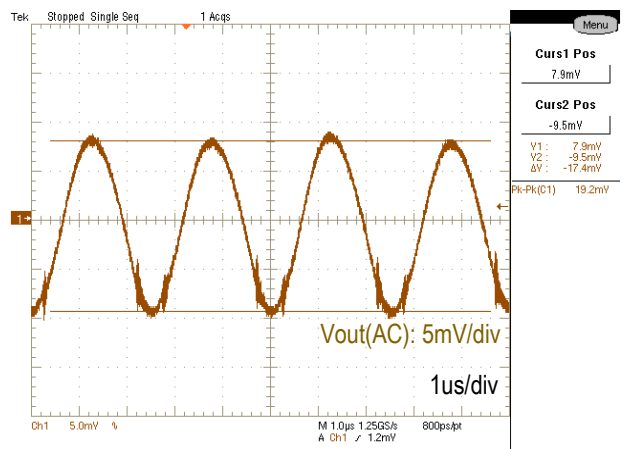

Step Load Transient Response (Vin=12.0V, Vout=2.5V, Cload=800uF, Iout=15A to 30A, 1.0A/us) Trace 2=Vout, 50mV/div, Trace 4=Iout, 20A/div.

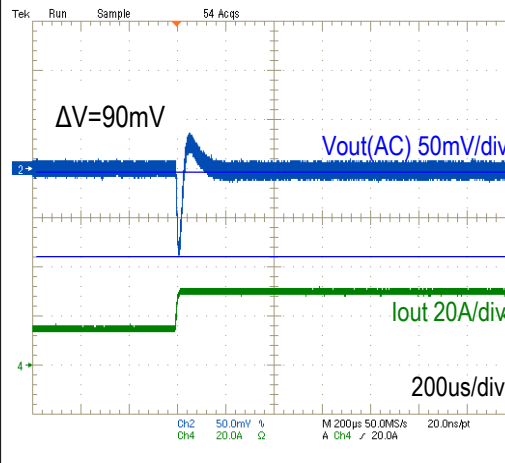

Step Load Transient Response (Vin=12.0V, Vout=2.5V, Cload=800uF, Iout=30 to 15A, 1.0A/us) Trace 2=Vout, 50mV/div, Trace 4=Iout, 20A/div.

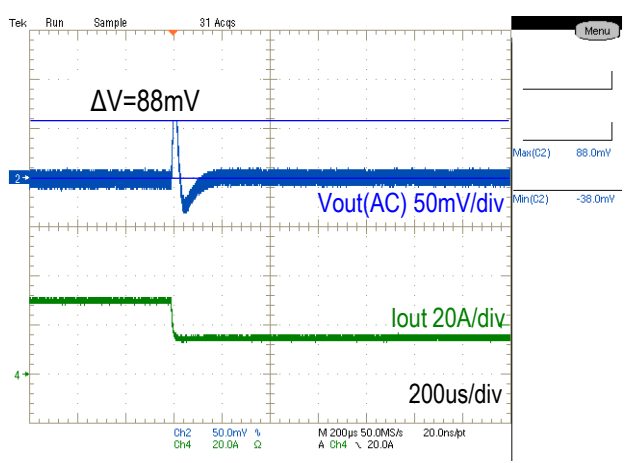



**PERFORMANCE DATA AND OSCILLOGRAMS OF MYSGK4R030ERSR**

Efficiency vs. Line Voltage and Load Current @ +25degC. (Vout = 3.3V)

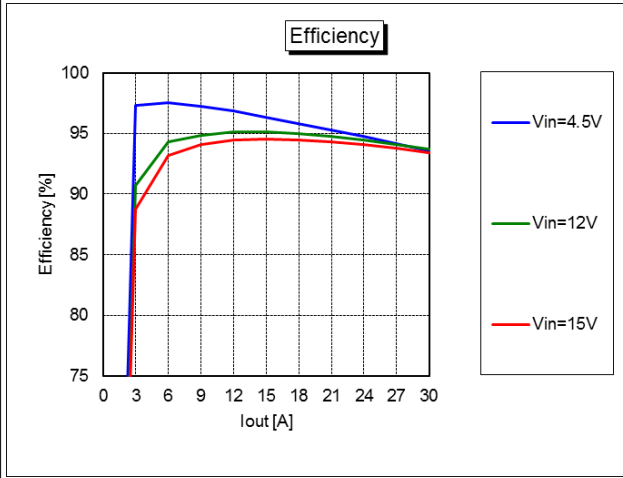

Vout vs. Line Voltage and Load Current @ +25degC. (Vout = 3.3V)

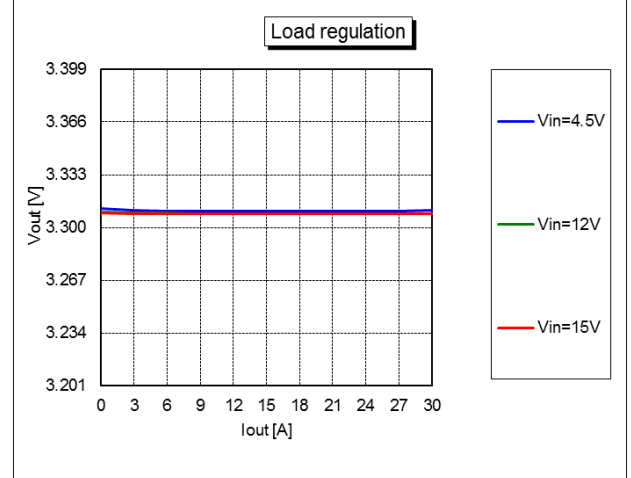

On/Off Enable Delay (Vin=12.0V, Vout=3.3V, Iout=30A, Cload=800uF)  
Trace1=Enable, Trace2=Vout, Trace3=P.G

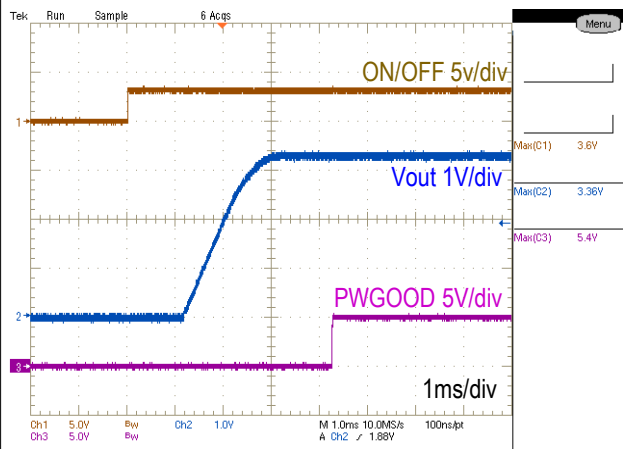

Output Ripple and Noise (Vin=12.0V, Vout=3.3V, Iout=30A, Cload=800uF, Scope BW=20MHz)

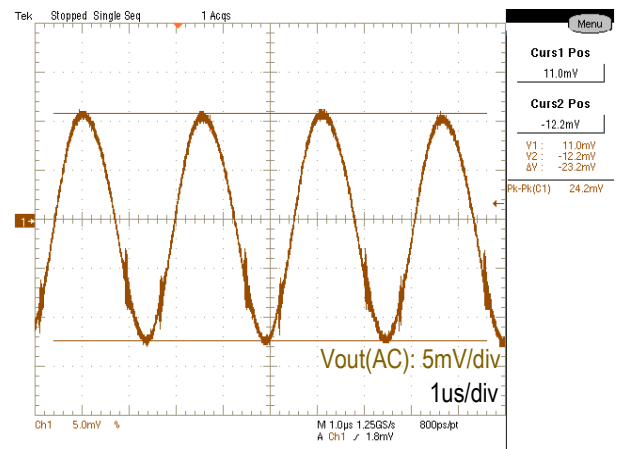

Step Load Transient Response (Vin=12.0V, Vout=3.3V, Co=800uF, Iout=15A to 30A, 1.0A/us) Trace 2=Vout, 100mV/div, Trace 4=Iout, 20A/div.

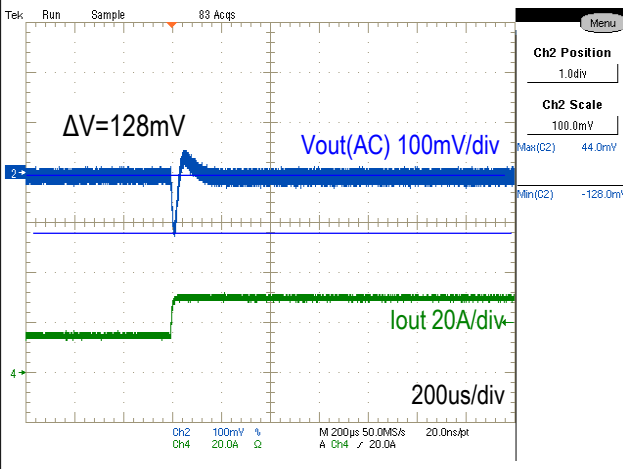

Step Load Transient Response (Vin=12.0V, Vout=3.3V, Cload=800uF, Iout=30 to 15A, 1.0A/us) Trace 2=Vout, 100mV/div, Trace 4=Iout, 20A/div.

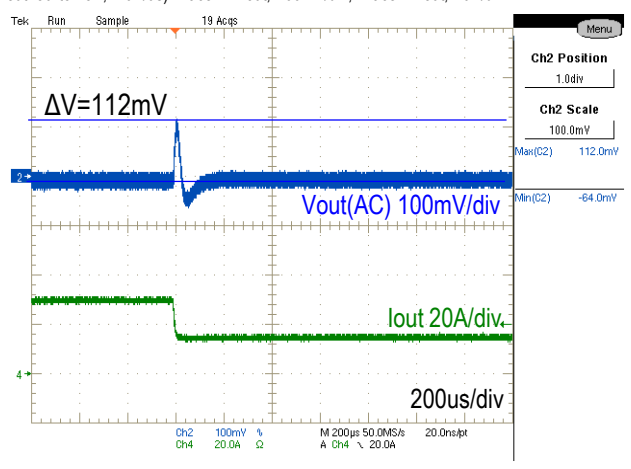

**PERFORMANCE DATA AND OSCILLOGRAMS OF MYSGK4R030ERSR**

Efficiency vs. Line Voltage and Load Current @ +25degC. (Vout = 4.0V)

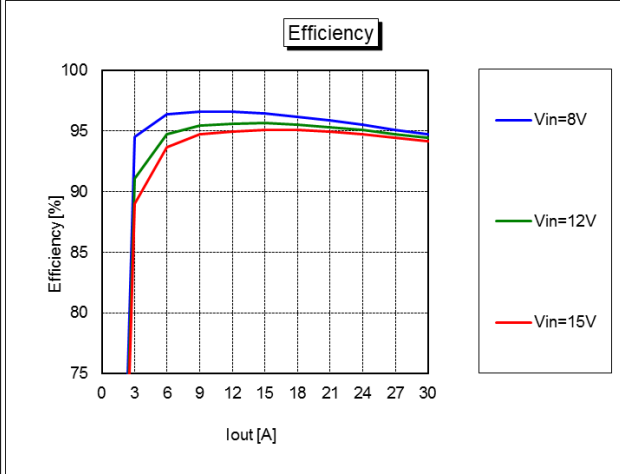

Vout vs. Line Voltage and Load Current @ +25degC. (Vout = 4.0V)

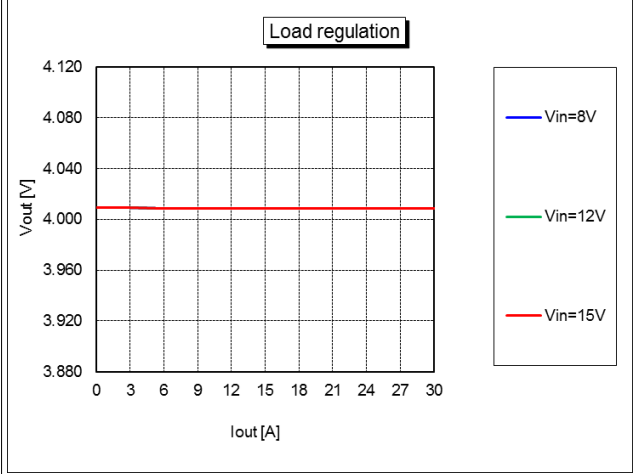

On/Off Enable Delay (Vin=12.0V, Vout=4.0V, Iout=30A, Cload=800uF)  
Trace1=Enable, Trace2=Vout, Trace3=P.G

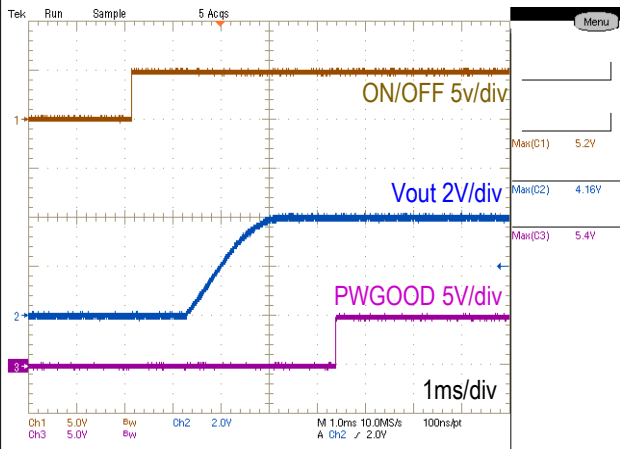

Output Ripple and Noise (Vin=12.0V, Vout=4.0V, Iout=30A, Cload=800uF, Scope BW=20MHz)

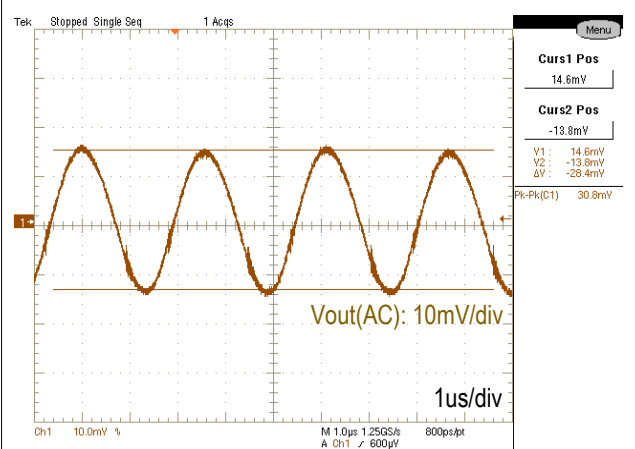

Step Load Transient Response (Vin=12.0V, Vout=4.0V, Co=800uF, Iout=15A to 30A, 1.0A/us) Trace 2=Vout, 100mV/div, Trace 4=Iout, 20A/div.

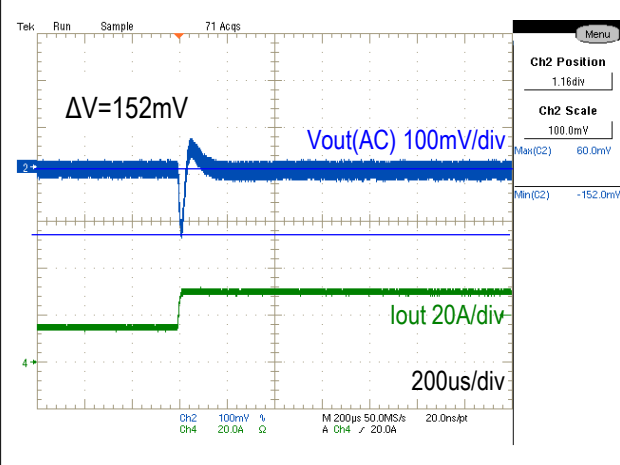

Step Load Transient Response (Vin=12.0V, Vout=4.0V, Cload=800uF, Iout=30 to 15A, 1.0A/us) Trace 2=Vout, 100mV/div, Trace 4=Iout, 20A/div.

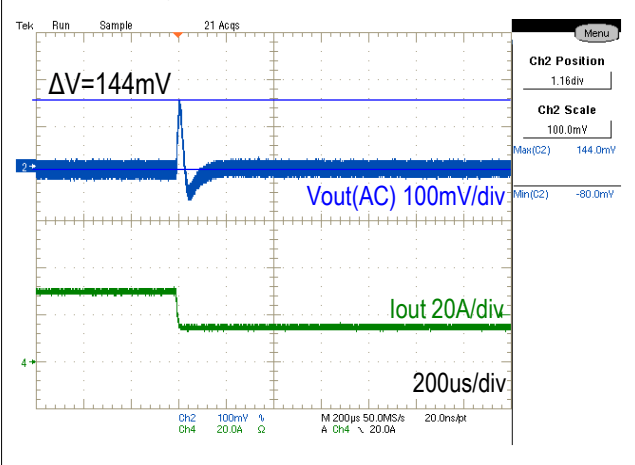

**THERMAL DERATINGS OF MYSGK4R030ERSR**

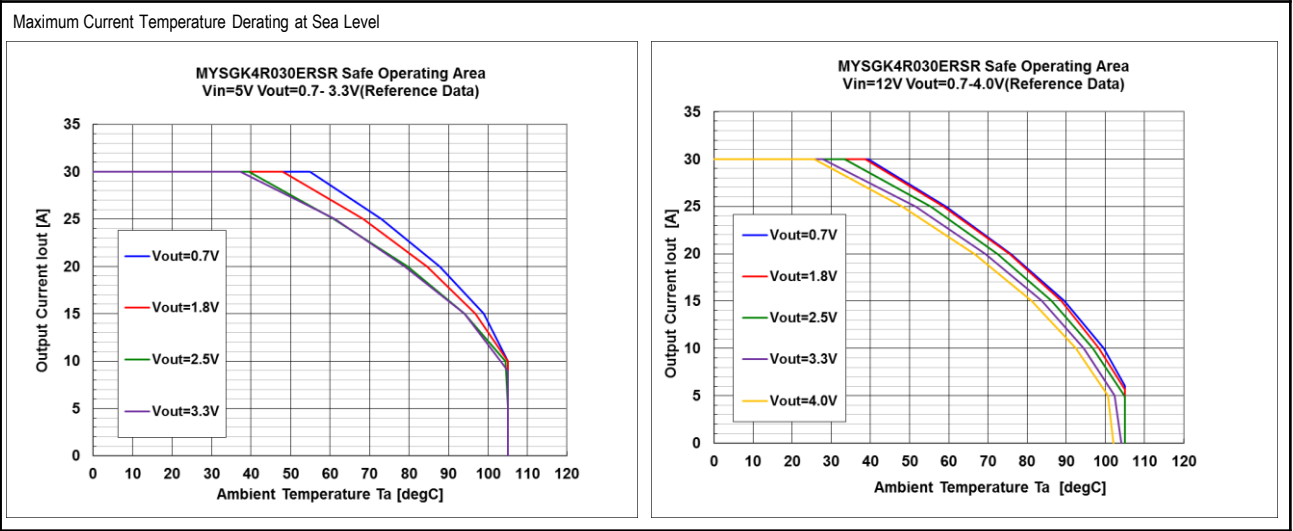

Thermal deratings are evaluated in following conditions.

- The product is mounted on 50.8mm x 60.0mm x 1.6mm (8 Layer, 2oz copper each) FR-4 board respectively.
- No forced air flow.

Surface(Top of the coil) temperature of the product : 115degC max.

**TRANSIENT RESPONSE DATAS OF MYSGK4R030ERSR**

Transient response data at various conditions are showed in following table.

Minimum output capacitance can serve less than 3% x Vout of deviation for 15A load change(0.5A/us).

Part Number	Vin(V)	Vout(V)	Cout(uF)	Voltage Deviation(mV)
				15-30A Load Step (0.5A/us)
MYSKG4R030ERSR	5	0.7	800	20
		1.8		45
		2.5		72
		3.3		96
	12	0.7	800	20
		1.8		46
		2.5		72
		3.3		96
		4.0		120

**MECHANICAL SPECIFICATIONS**

**Dimension and Pin Assignment**

< Top View >

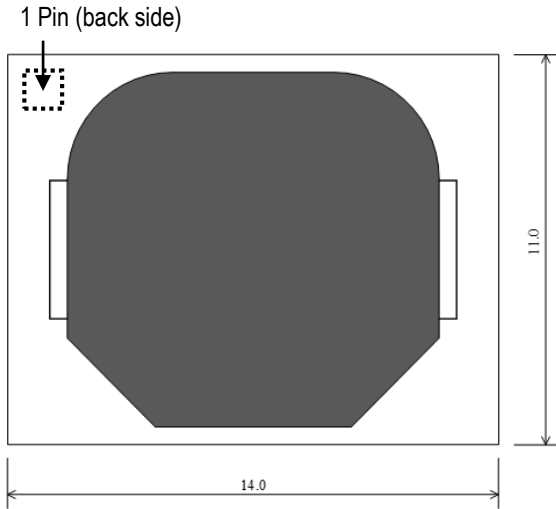

< Bottom View >

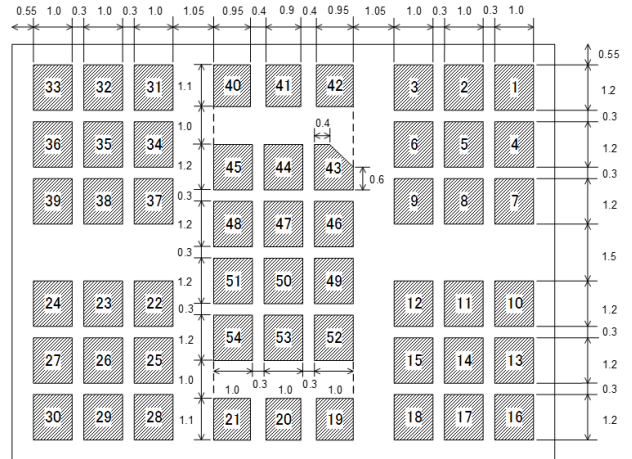

Unit: mm  
Tolerances  
± 0.25mm



< Side View >

INPUT/OUTPUT CONNECTIONS	
Pin No.	Function
1-9	GND
10-18	Vout
19	+Sense
20	Trim
21	-Sense
22-30	GND
31-39	Vin
40	ON/OFF
41	N.C.
42	Power Good
43-54	GND(Thermal Pad)

**Recommended Board Land Pattern (Top View)**

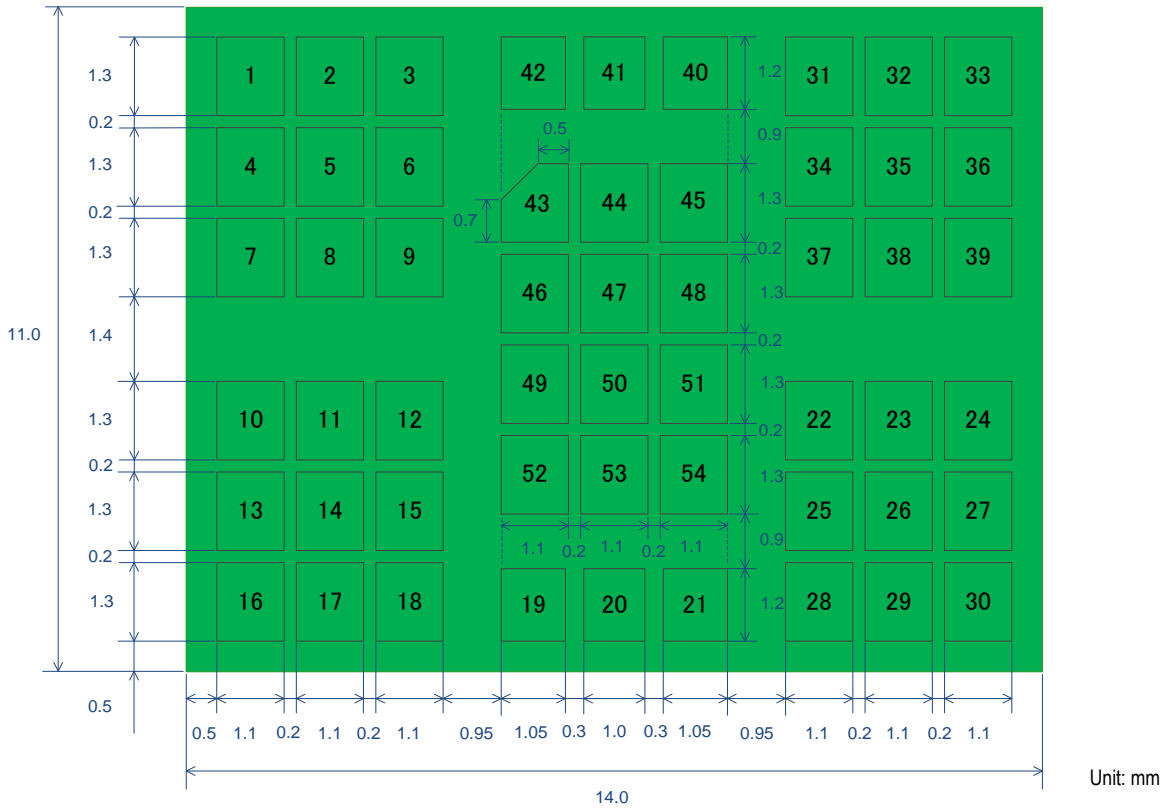

**Example of Pattern Layout (Top View)**

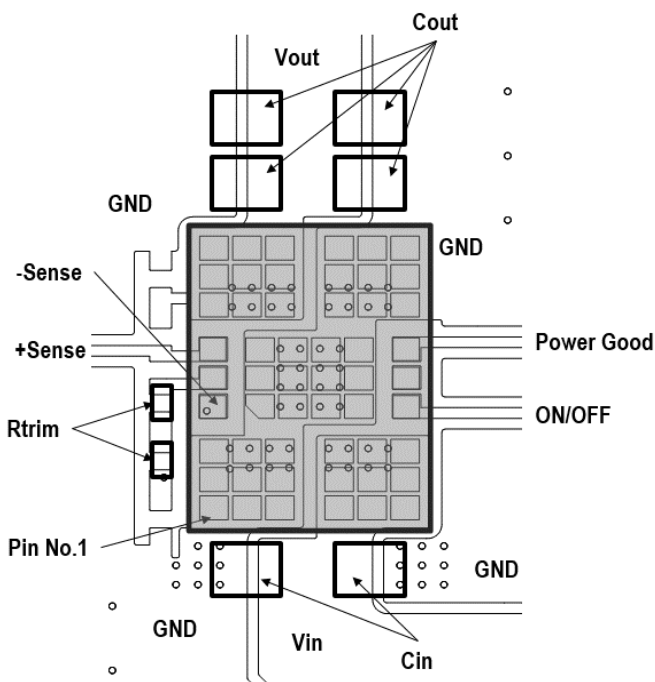

**Picture**

**TOP VIEW**

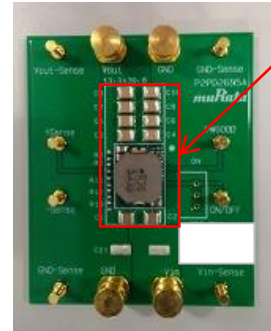

**30.8 x 13.0(mm)**

**BOTTOM VIEW**





**TAPE SPECIFICATIONS**

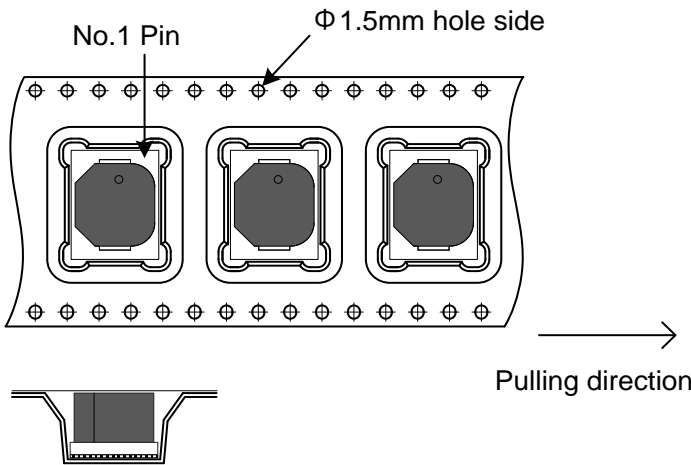
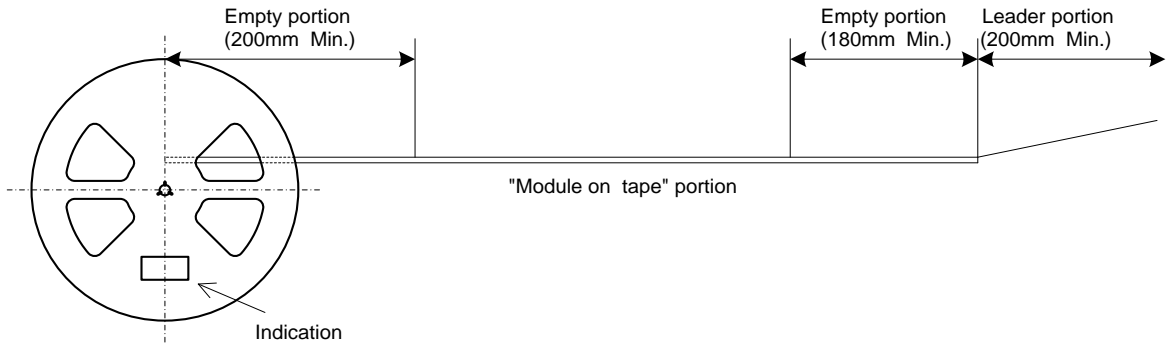

**Note**

1. The adhesive strength of the protective tape must be within 0.1-1.3N.
2. Each reel contains the quantities such as the table below.
3. Each reel set in moisture-proof packaging because of MSL 3.
4. No vacant pocket in "Module on tape" section.
5. The reel is labeled with Murata part number and quantity.
6. The color of reel is not specified.

Part Number	Qty(pcs)
MYSGK4R030ERSR	150
MYSGK4R030ERSRD	50

**TECHNICAL NOTES**

**Input Fuse**

Certain applications and/or safety agencies may require fuses at the inputs of power conversion components. Fuses should also be used when there is the possibility of sustained input voltage reversal which is not current limited. For greatest safety, we recommend a fast blow fuse installed in the ungrounded input supply line. The installer must observe all relevant safety standards and regulations. For safety agency approvals, install the converter in compliance with the end-user safety standard.

**Input Under-Voltage Shutdown and Start-Up Threshold**

Under normal start-up conditions, converters will not begin to regulate properly until the ramping-up input voltage exceeds and remains at the Start-Up Threshold Voltage (see Specifications). Once operating, converters will not turn off until the input voltage drops below the Under-Voltage Shutdown Limit. Subsequent restart will not occur until the input voltage rises again above the Start-Up Threshold. This built-in hysteresis prevents any unstable on/off operation at a single input voltage. Users should be aware however of input sources near the Under-Voltage Shutdown whose voltage decays as input current is consumed (such as capacitor inputs), the converter shuts off and then restarts as the external capacitor recharges. Such situations could oscillate. To prevent this, make sure the operating input voltage is well above the UV Shutdown voltage at all times.

**Start-Up Time**

Assuming that the output current is set at the rated maximum, the Vin to Vout Start-Up Time (see Specifications) is the time interval between the point when the ramping input voltage crosses the Start-Up Threshold and the fully loaded regulated output voltage enters and remains within its specified accuracy band. Actual measured times will vary with input source impedance, external input capacitance, input voltage slew rate and final value of the input voltage as it appears at the converter. These converters include a soft start circuit to moderate the duty cycle of its PWM controller at power up, thereby limiting the input inrush current. The On/Off Remote Control interval from On command to Vout regulated assumes that the converter already has its input voltage stabilized above the Start-Up Threshold before the On command. The interval is measured from the On command until the output enters and remains within its specified accuracy band. The specification assumes that the output is fully loaded at maximum rated current. Similar conditions apply to the On to Vout regulated specification such as external load capacitance and soft start circuitry.

**Recommended Input Filtering**

The user must assure that the input source has low AC impedance to provide dynamic stability and that the input supply has little or no inductive content, including long distributed wiring to a remote power supply. For best performance, we recommend installing a low-ESR capacitor immediately adjacent to the converter's input terminals. The capacitor should be a ceramic type such as the Murata GRM32 series and an electrolytic type such as Panasonic OS-CON series.

Initial suggested capacitor values are 22uF x 2 ceramic type and 1000uF x 1 electrolytic type, rated at twice the expected maximum input voltage. Make sure that the input terminals do not go below the under voltage shutdown voltage at all times. More input bulk capacitance may be added in parallel (either electrolytic or tantalum) if needed.

**Recommended Output Filtering**

The converter will achieve its rated output ripple and noise with additional external capacitor. The user may install more external output capacitance reduce the ripple even further or for improved dynamic response. Again, use low-ESR ceramic (Murata GRM32 series). Initial values of 100uF x 8 ceramic type may be tried, either single or multiple capacitors in parallel. Mount these close to the converter. Measure the output ripple under your load conditions. Use only as much capacitance as required to achieve your ripple and noise objectives. Excessive capacitance can make step load recovery sluggish or possibly introduce instability. Do not exceed the maximum rated output capacitance listed in the specifications.

**Output Noise**

All models in this converter series are tested and specified for output noise using designated external input/output components, circuits and layout as shown in the figures below. In the figure below, the two copper strips simulate real-world printed circuit impedances between the power supply and its load. In order to minimize circuit errors and standardize tests between units, scope measurements should be made using BNC connectors or the probe ground should not exceed one half inch and soldered directly to the test circuit.

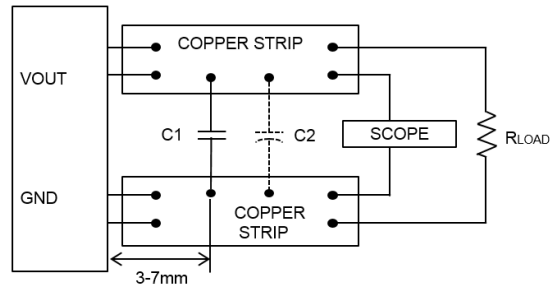

C1=100uF x 8 CERAMIC

C2=OPEN

Figure : Measuring Output Ripple and Noise

**Minimum Output Loading Requirements**

All models regulate within specification and are stable under no load to full load conditions. Operation under no load might however slightly increase output ripple and noise.

**Thermal Shutdown**

To prevent many over temperature problems and damage, these converters include thermal shutdown circuitry. If environmental conditions cause the temperature of the converter's to rise above the Operating Temperature Range up to the shutdown temperature, an on-board electronic temperature sensor will power down the unit. When the temperature decreases below the turn-on threshold, the converter will automatically restart.



**CAUTION:** If you operate too close to the thermal limits, the converter may shut down suddenly without warning. Be sure to thoroughly you're your application to avoid unplanned thermal shutdown.

**Temperature Derating Curves**

The graphs in this data sheet illustrate typical operation under a variety of conditions. The derating curves show the maximum continuous ambient air temperature. Note that these are AVERAGE measurements.

Note that the temperatures are of the ambient airflow, not the converter itself which is obviously running at higher temperature than the outside air. Also note that very low flow rates (below about 25 LFM) are similar to "natural convection," that is, not using fan-forced airflow. Murata makes Characterization measurements in a closed cycle wind tunnel with calibrated airflow. We use both thermocouples and an infrared camera system to observe thermal performance.

**CAUTION:** These graphs are all collected at slightly above Sea Level altitude. Be sure to reduce the derating for higher density altitude.

**Output Current Limiting**

Current limiting inception is defined as the point at which full power falls below the rated tolerance. See the Performance/Functional Specifications. Note particularly that the output current may briefly rise above its rated value in normal operation as long as the average output power is not exceeded. This enhances reliability and continued operation of your application. If the output current is too high, the converter will enter the short circuit condition.

**Output Short Circuit Condition**

When a converter is in current-limit mode, the output voltage will drop as the output current demand increases. Following a time-out period, the converter will restart, causing the output voltage to begin ramping up to its appropriate value. If the short-circuit condition persists, another shutdown cycle will initiate. This rapid on/off cycling is called "hiccup mode". The hiccup cycling reduces the average output current, thereby preventing excessive internal temperatures and/or component damage. A short circuit can be tolerated indefinitely.

The "hiccup" system differs from older latching short circuit systems because you do not have to power down the converter to make it restart. The system will automatically restore operation as soon as the short circuit condition is removed.

**UVP/OVP Function**

This product monitors a feedback voltage to detect over and under voltage. When the feedback voltage becomes lower than 68% of the target voltage, after 1ms, the product latches OFF. This function is enables after soft-start is complete.

When the feedback voltage becomes higher than 120% of the target voltage, the circuit operates sink-mode to decrease output voltage until reaching a negative current limit (-49A typ.). Upon reaching the negative current limit, sink-mode is turned off and the device restarts for a short time. The device operates in this cycle until the output voltage is pulled down under the UVP threshold voltage for 1ms. After the 1ms, the circuit latches into sink-mode. The fault is cleared with a reset of Vin or by retoggling the ON/OFF pin.

**Remote On/Off Control**

Please refer to the Connection Diagram on page 1 for On/Off connections.

Positive logic models are enabled when the On/Off pin is left open or is pulled high to Vin with respect to GND. An internal bias current causes the open pin to rise to Vin. Positive-polarity devices are disabled when the On/Off is grounded or brought to within a low voltage (see Specifications) with respect to GND.

Dynamic control of the On/Off function should be able to sink appropriate signal current when brought low and withstand appropriate voltage when brought high. Be aware too that there is a finite time in milliseconds (see Specifications) between the time of On/Off Control activation and stable, regulated output. This time will vary slightly with output load type and current and input conditions.

**Output Capacitive Load**

Users should only consider adding capacitance to reduce switching noise and/or to handle spike current load steps. Install only enough capacitance to achieve noise objectives. Excess external capacitance may cause regulation problems, degraded transient response and possible oscillation or instability.

**Soldering Guidelines**

Murata recommends the specifications below when installing these converters. These specifications vary depending on the solder type.

Exceeding these specifications may cause damage to the product. Your production environment may differ therefore please thoroughly review these guidelines with your process engineers. This product can be reflowed once.

Reflow Solder Operations for surface-mount products	
For Sn/Ag/Cu based solders:	
Preheat Temperature	Less than 1degC per second
Time over Liquidus	45 to 75 seconds
Maximum Peak Temperature	250degC
Cooling Rate	Less than 3degC per second
For Sn/Pb based solders:	
Preheat Temperature	Less than 1degC per second
Time over Liquidus	60 to 75 seconds
Maximum Peak Temperature	235degC
Cooling Rate	Less than 3degC per second

**Recommended Lead-free Solder Reflow Profile**

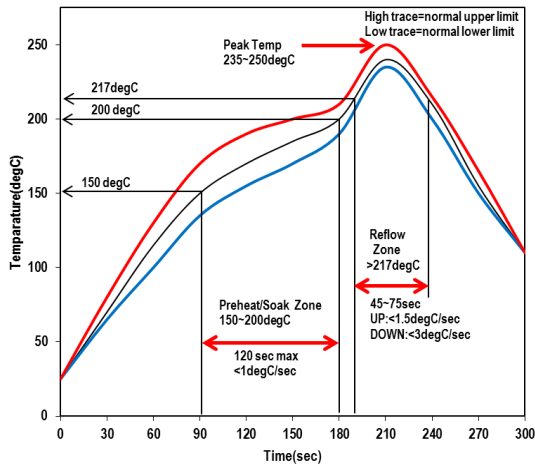

**CAUTION: Do not reflow the converter as follows, because the converter may fall from the substrate during reflowing.**

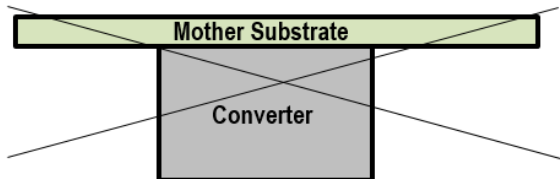

**Pb-free solder processes**

For Pb-free solder processes, the product is qualified for MSL 3 according to IPC/JEDEC standard J-STD-020D. During reflow PRODUCT must not exceed 250degC at any time.

**Dry Pack Information**

Products intended for Pb-free reflow soldering processes are delivered in standard moisture barrier bags according to IPC/JEDEC standard J-STD-033. (Handling, packing, shipping and use of moisture/reflow sensitivity surface mount devices.) Using products in high temperature Pb-free soldering processes requires dry pack storage and handling. In case the products have been stored in an uncontrolled environment and no longer can be considered dry, the modules must be baked according to J-STD-033.

**Voltage Range Graph**

Please observe the lower limit below for voltage input and output ranges. The limit is applied for all output currents.

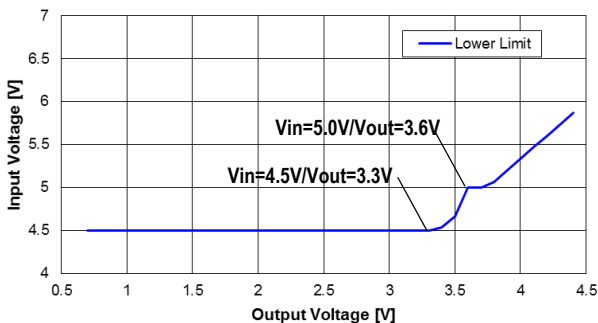

**Output Voltage Adjustment**

The output voltage may be adjusted over a limited range by connecting an external trim resistor (Rtrim) between the Trim pin and GND pin. The Rtrim resistor must be a 1/10W precision metal film type, ±0.5% accuracy or better with low temperature coefficient, ±100ppm/degC or better. Mount the resistor close to the converter with very short leads or use a surface mount trim resistor.

In the table below, the estimated resistance is given at limited condition ; Vin : typ., Ta : 25degC, Iout : max., Cout : 800uF. (Please look at Test Circuit which is shown below). Do not exceed the specified limits of the output voltage or the converter's maximum power rating when applying these resistors. Also, avoid high noise at the Trim input. However, to prevent instability, you should never connect any capacitors between Trim pin and GND pin.

	Estimated Rtrim (kohm)
Output Voltage	MYSGK4R030ERSR
0.7V	56+3.9
1.8V	3.0+2.0
2.5V	3.0+0.16
3.3V	2.2+0.02
4.0V	1.2+0.56

**Resistor Trim Equation**

MYSGK4R030ERSR

$$R_{trim} \text{ (kohm)} = \frac{5.996}{(V_{out} - 0.5996)}$$

Output voltage depends on the value of capacitance of Cout in this product , the smaller Cout may cause the higher output voltage. The equations above are only reference, so please check output voltage and adjust Rtrim in user circumstances. To increase(decrease) output voltage is obtained by decreasing(increasing) value of Rtrim .

**Output Voltage Remote Sense**

This function is capable to compensate up the voltage drop between the output and input of load. The voltage between Vout pin and GND pin must NOT be over their allowed maximum voltage if using the remote sense. The both sense pins should be connected to Vout line and GND line respectively as shortly as possible. The sense traces should be also shielded by GND line or something else to reduce noise pickup. The sense line length is recommended within 10cm for output voltage stability. If the sense function is not needed, the +Sense pin should be connected to the Vout pin directly, the -Sense pin should be also connected to GND pin directly.

APPENDIX

Test Circuit

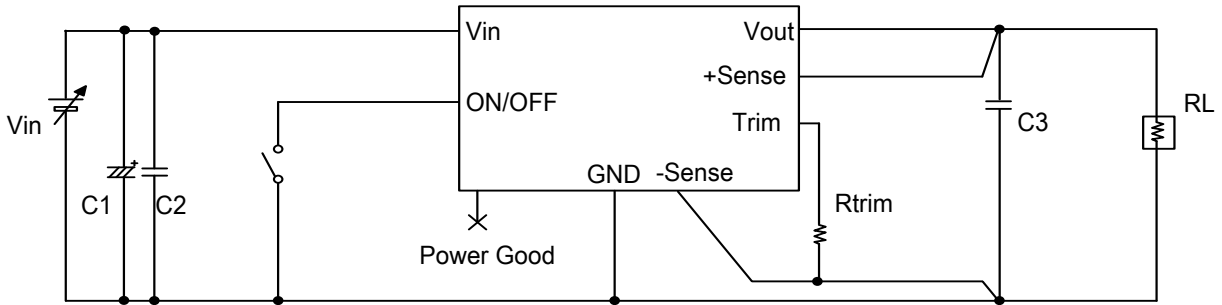

Vin : DC Power Supply  
RL : Electronic Load Device

For MYSGK4R030ERSR  
C1 : 1000uF/25V x 1pc Electrolysis Capacitor  
C2 : 22uF/25V x 2pcs (GRM32ER71E226KE15 : Murata)  
C3 : 100uF/6.3V x 8pcs (GRM32EE70J107ME15 : Murata)

Do not connect any additional components between the Trim pin and Vout or between the Trim and Sense pins. Use only the specified connections.

If there is a long inductive cable length between the input power source and converter, then some additional bulk decoupling capacitance (eg. up to 1000uF) may be necessary to ensure a low AC impedance power source.

This would typically be aluminum electrolytic type and does not need to be close to the input terminals of converter.



This product is subject to the following [operating requirements](#) and the [Life and Safety Critical Application Sales Policy](#):  
Refer to: <https://power.murata.com/en/requirements>

Murata Manufacturing Co., Ltd makes no representation that the use of its products in the circuits described herein, or the use of other technical information contained herein, will not infringe upon existing or future patent rights. The descriptions contained herein do not imply the granting of licenses to make, use, or sell equipment constructed in accordance therewith. Spec and cautions are subject to change without notice. © 2019 Murata Manufacturing Co., Ltd

# Mouser Electronics

Authorized Distributor

Click to View Pricing, Inventory, Delivery & Lifecycle Information:

[Murata:](#)

[MYSGK4R030ERSR](#) [MYSGK4R030ERSRD](#)