

Description

The TM-500 Tele-Mate® Telephone Test Set is intended to troubleshoot analog telecommunication circuits. Its features include:

- DSL compatibility
- Tone or Pulse dialing
- Mute function
- Luminescent keypad
- Storage of up to 10 telephone numbers
- LNR (Last Number Redial)
- Impact resistant

Safety

Safety is essential in the use and maintenance of Greenlee tools and equipment. This instruction manual and any markings on the tool provide information for avoiding hazards and unsafe practices related to the use of this tool. Observe all of the safety information provided.

Purpose of this Manual

This manual is intended to familiarize personnel with the safe operation and maintenance procedures for the Greenlee Communications TM-500 Tele-Mate® Telephone Test Set.

Keep this manual available to all personnel.

Replacement manuals are available upon request at no charge at www.greenlee.com.



Do not discard this product or throw away!
For recycling information, go to www.greenlee.com.

KEEP THIS MANUAL

One-Year Limited Warranty

Greenlee Textron Inc. warrants to the original purchaser of these goods for use that these products will be free from defects in workmanship and material for their useful life, excepting normal wear and abuse.

For all Test Instrument repairs, you must first request a Return Authorization Number by contacting our Customer Service department at: toll free in the US and Canada 800 642-2155; Telephone +1 760 598-8900; Facsimile +1 760 598-5634.

This number must be clearly marked on the shipping label. Ship units Freight Prepaid to:

Greenlee Repair Center, 1390 Aspen Way, Vista CA 92081 USA. Mark all packages: Attention: TEST INSTRUMENT REPAIR.

For items not covered under warranty (such as dropped, abused, etc.) repair cost quote available upon request.

Note: EMEA users—contact Greenlee Communications Ltd., Brecon House, William Brown Close, Cwmbarn, NP44 3AB, UK +44 1633 627 710.

Important Safety Information

	⚠ WARNING
	Electric shock hazard: Contact with live circuits could result in severe injury or death.

⚠ WARNING
Electric shock hazard: Environment: Do not use in wet conditions. Do not connect to network if apparatus is wet. This device is rated to IP20. Failure to observe this warning could result in severe injury or death.

⚠ CAUTION
<ul style="list-style-type: none">• This unit is to be used by trained personnel only.• Do not perform any service or maintenance other than as instructed in this manual. Failure to observe these precautions may result in injury or property damage.

⚠ CAUTION
<ul style="list-style-type: none">• Inspect the test set and cord for wear or damage. Replace worn, damaged, or missing components with Greenlee replacement parts. A damaged component may fail, resulting in injury or property damage.• If the equipment is used in a manner not specified by the manufacturer, the protection provided by the equipment may be impaired.

Maintenance

Impact

The TM-500 is highly impact resistant. Even if dropped onto concrete, this unit should survive without permanent damage. In the event that the top of the case opens up during impact, it should be possible to push it back together again. Do not attempt to open the case to make a repair nor should any force be used. If a simple local fix is not possible, return the unit for repair.

Field Repair

Field repairs are limited to replacing line cords (with approved types) and replacing belt clips. Attempting any other repair at field level is liable to damage the instrument and will invalidate the manufacturer's warranty. Check your company policy before considering any repair. Although limited field repair may be possible, your company may have a policy of centralized repair.

Changing Line Cord

1. Disconnect the unit from the circuit.
2. Remove the screw and slide the cover off.

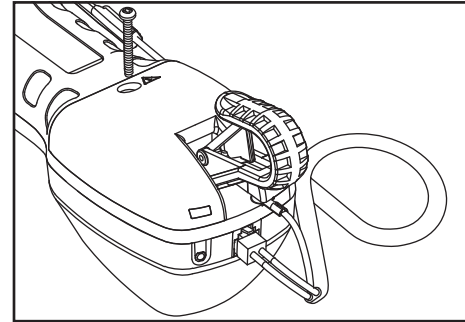

3. Disconnect the strain relief.

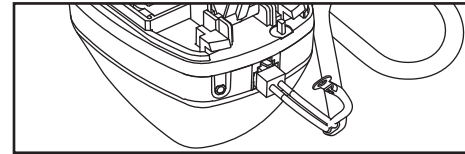

4. Replace the line cord and reconnect the strain relief.

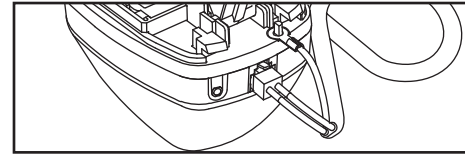

5. Slide the cover back on and tighten the screw.

Cleaning

For cleaning it is recommended to only use a cloth dampened with a solution of soap and water.

INSTRUCTION MANUAL

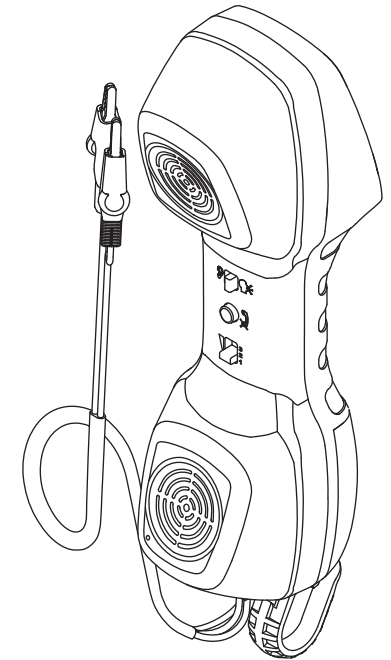

TM-500 Tele-Mate® Telephone Test Set

	⚠ WARNING
	Read and understand this material before operating or servicing this equipment. Failure to understand how to safely operate this tool could result in an accident causing serious injury or death.

Register this product at www.greenlee.com

© 2011 Greenlee Textron Inc.



4455 Boeing Drive • Rockford, IL 61109-2988 • USA • 815-397-7070
An ISO 9001 Company • Greenlee Textron Inc. is a subsidiary of Textron Inc.

USA	Canada	International
Tel: 800-435-0786	Tel: 800-435-0786	Tel: +1-815-397-7070
Fax: 800-451-2632	Fax: 800-524-2853	Fax: +1-815-397-9247

Europe, Middle East, Africa, Asia & Pacific
Greenlee Communications Ltd.

Brecon House • William Brown Close • Cwmbarn, NP44 3AB • UK
Tel: +44 1633 627 710 • EMEAsales@greenlee.textron.com

www.greenlee.com

Identification

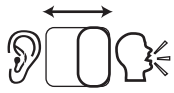
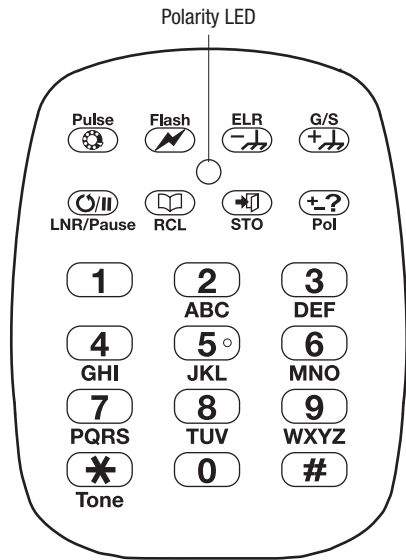

MONITOR / TALK Switch



MUTE Button



Volume Control Switch

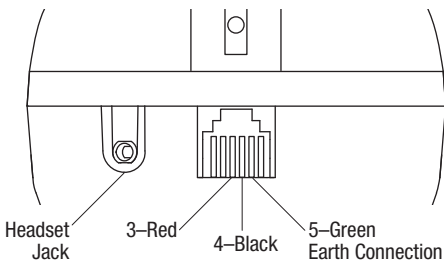

Operation



Talk Mode

Slide switch to **TALK** to go off-hook (connect).

CAUTION

This device is for connection to TNV3 network voltages only. Use this unit only on standard analog Telecom networks. If this unit is **accidentally** connected to an over-voltage condition, it will attempt to protect itself:

- Raw battery and V up to 90 VDC: Clicks and/or beeps heard repeatedly in the earpiece while fault exists.
- 90 V to 180 V: Continuous ringing heard.

Disconnect the unit as soon as possible as damage may occur.

Connection to voltages in excess of 200 VDC can cause permanent damage to the unit.

Slide switch to **MONITOR** to go back on-hook (disconnect).

The TM-500 test set is DSL compatible and can be used on a DSL enabled line without the need of an external DSL filter.



Monitor Mode (high impedance)

Slide switch to **MONITOR**.

In this mode, the unit can monitor audio signals on the line. No power from the line is needed.



Mute

Press and hold the **MUTE** button to cut off transmission during a call.



Volume Control (Talk mode only)

Slide switch to 1, 2, or 3 to satisfy earpiece volume level requirements in Talk mode.



Polarity Test

Press **Pol** and observe the polarity LED. In the presence of power, the LED will light either red or green:

- Red LED: red lead is connected to Tip/A/+Ve.
- Green LED: red lead is connected to Ring/B/-Ve.

During ringing, both red and green LEDs will light in turn and may appear amber.



Last Number Redial and Pause

Press **LNR/Pause** immediately after off-hook to redial the previous number dialed. In Store mode, press **LNR/Pause** to insert a 4 second pause in a memory. Press **LNR/Pause** again to increase the pause duration.



Flash

Press **Flash** to generate a timed line break. The settings are 100 ms (default), 300 ms, or 600 ms.



Storing a Number in Memory

There are 10 memory locations, one under each of the dialing digits (0–9).

While connected to a line and in Talk mode:

1. Press **STO** to enter Store mode.
2. Enter the telephone number to be stored.
3. Press **STO** and a location (0–9) to store. The number is stored under the button chosen.

In memory you may also store *, #, **Flash**, or **LNR/Pause**. These will be redialed as they were entered.



Memory Recall—Dialing a Number from a Memory Location

While connected to a line and in Talk mode:

1. Press **RCL**.
2. Press the location digit (0–9). The stored number under that button will be redialed.

Multiple memories can be recalled, one after the other.



Pulse Dialing

In Talk mode, press **Pulse** before dialing. Pulse mode is confirmed by a single high beep in the earpiece. Dialing mode will automatically revert to Tone when the line is disconnected or the unit is switched to Monitor mode.

Mixed Pulse and Tone Dialing

Select Pulse mode as above and dial the pulse digits. Press * (**Tone**) and then dial the tone digits (the star will not be dialed out). This will be stored in the Last Number Redial memory as dialed. Redialing will be mixed mode if in Pulse mode when redial is attempted. If Tone mode is selected, all digits will be dialed in Tone including the star.

Setup Mode

In Talk mode, press **STO** and * together. Use the following table and the numerical keys to set up the unit to meet your local requirements.

			ETSI	USA	
1	Pulse Rate	1	10 pps	@	\$
		2	20 pps		
2	Flash Duration	1	100 ms	@	
		2	300 ms		
		3	600 ms		\$
3	DTMF Level	1	High		\$
		2	Low	@	
4	Make/Break Ratio	1	60/40	@	\$
		2	67/33		
5	Send Level	1	High		\$
		2	Low	@	
7	Sidetone	1	High		\$
		2	Low	@	
0	Defaults	2	ETSI	@	
		3	USA		\$

Press * to save changes and exit, or slide switch to **MONITOR** to ignore changes.



Ground-Start Lines

Using an adapter to connect a green wire to Pin 5 of the line cord jack:

1. Connect green wire to ground.
2. In Talk mode, press **G/S** momentarily.
3. Check for a dial tone.



Earth Loop Recall

Using an adapter to connect a green wire to Pin 5 of the line cord jack:

1. In Talk mode on a looped line and with the green wire to ground, press **ERL** momentarily.
2. Check for a second dial tone.

Hands-Free Mode

The TM-500 can be used hands-free with the headset plugged into its socket at the base of the unit. Only use the supplied headset.