

1 2 3 4 5 6

A

B

C

D

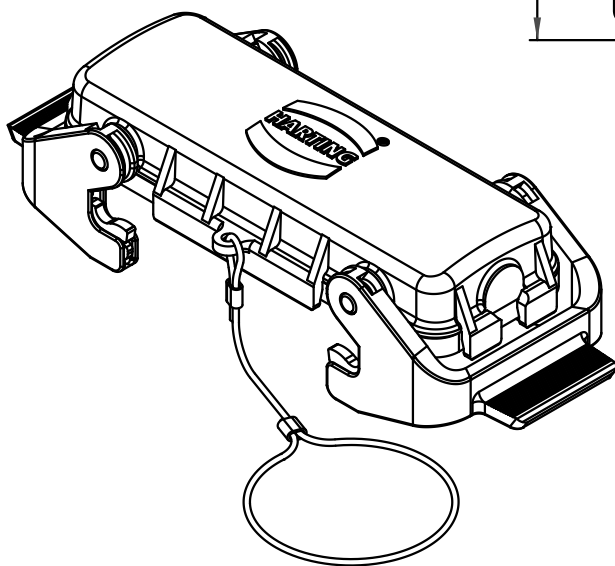
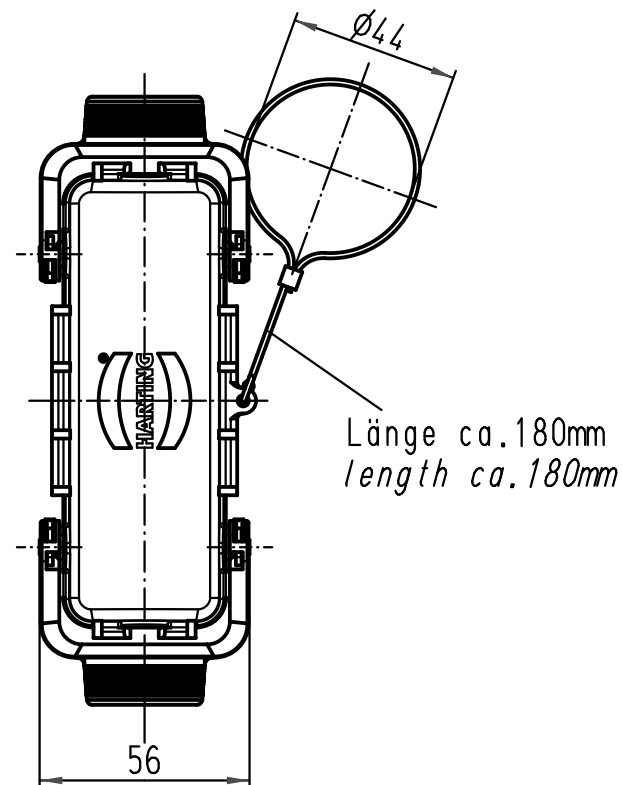
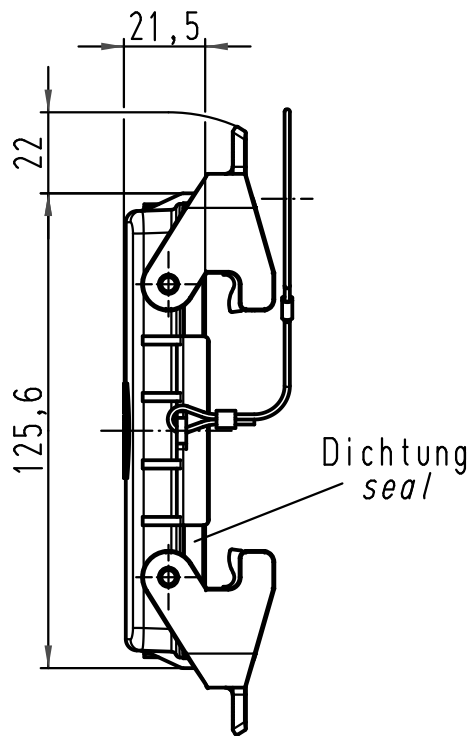

All Dimensions in mm Original Size DIN A 4		Techn. Character.			Nicht tolerierte Maß/Free size tolerances	
			Dat.	Name	Maßstab/Scale 1:2	Han 24B-AK-QB Metallabdeckkappe metal cover
			Detail.	01.12.08 Bor		
			Insp.	Sch		
			Stand.			
A			HARTING Electric GmbH & Co. KG			TB 09 30 024 5422
Mod.	Dat.	Name	D-32339 Espelkamp			
Sub. TB 09 30 024 5422 v. 01.10.01						Blatt/page