



Model Number

RL31-8-1200-RT/73c/136

Diffuse mode sensor
with 4-pin, M12 x 1 connector

Features

- Highly visible LED
- Powerful push-pull output
- Red transmission light
- Compact and stable housing
- Protection class II

Dimensions

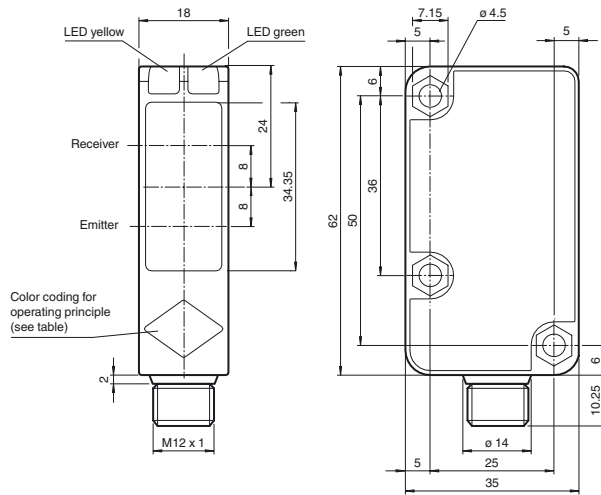

Operating principle	color
Retroreflective sensor with polarisation filter	green
Retroreflective sensor	blue
Diffusive mode sensor	white
Thru-beam sensor	grey
Diffusive mode sensor with background suppression	red

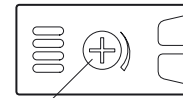

Sensing range adjuster

Electrical connection

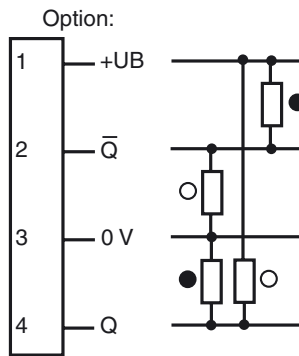

Pinout

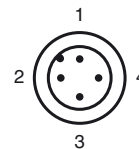

Indicators/operating means

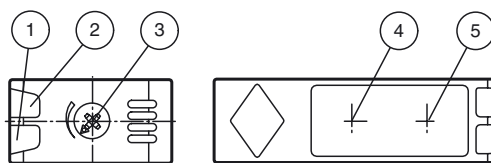

1	Operating display	green
2	Signal display	yellow
3	Sensing range adjuster	
4	Emitter	
5	Receiver	

Technical data**General specifications**

Detection range	0 ... 1200 mm adjustable
Detection range max.	0 ... 1200 mm
Reference target	standard white, 100 mm x 100 mm
Light source	LED
Light type	modulated visible red light , 630 nm
Diameter of the light spot	approx. 25 mm at a distance of 1.2 m
Angle of divergence	2 °
Ambient light limit	50000 Lux ; according EN 60947-5-2

Functional safety related parameters

MTTF _d	920 a
Mission Time (T _M)	20 a
Diagnostic Coverage (DC)	0 %

Indicators/operating means

Operation indicator	LED green: power on
Function indicator	LED yellow, lights up with receiver lit
Control elements	Detection range adjuster

Electrical specifications

Operating voltage	U _B	10 ... 30 V DC
Ripple		10 %
No-load supply current	I ₀	≤ 20 mA

Output

Switching type	light on	
Signal output	2 push-pull (4 in 1) outputs, short-circuit protected, reverse polarity protected	
Switching voltage	max. 30 V DC	
Switching current	max. 100 mA	
Voltage drop	U _d	≤ 1.5 V
Switching frequency	f	≤ 500 Hz
Response time		≤ 1 ms

Ambient conditions

Ambient temperature	-30 ... 55 °C (-22 ... 131 °F)
Storage temperature	-40 ... 70 °C (-40 ... 158 °F)

Mechanical specifications

Degree of protection	IP67
Connection	4-pin, M12 x 1 connector
Material	
Housing	Polycarbonate
Optical face	PMMA
Mass	25 g

Compliance with standards and directives

Directive conformity	EMC Directive 2004/108/EC
Standard conformity	
Product standard	EN 60947-5-2:2007 IEC 60947-5-2:2007

Approvals and certificates

Protection class	II , rated insulation voltage ≤ 250 V AC with pollution degree 1-2 according to IEC 60664-1 Output circuit basis insulation of input circuit according to EN 50178, rated insulation voltage 240 V AC
UL approval	cULus Listed, Class 2 Power Source, Type 1 enclosure
CCC approval	CCC approval / marking not required for products rated ≤36 V

Accessories

OMH-RL31-01
Mounting bracket

OMH-RL31-02
Mounting bracket narrow

OMH-RL31-03
Mounting bracket narrow

OMH-RL31-04
Mounting aid for round steel ø 12 mm or sheet 1.5 mm ... 3 mm

OMH-RL31-05
Mounting bracket with M10 threaded rod

OMH-RL31-06
Stainless steel mounting bracket with adjustable half clamp on the side

V1-G-2M-PUR
Female cordset, M12, 4-pin, PUR cable

V1-W-2M-PUR
Female cordset, M12, 4-pin, PUR cable

Other suitable accessories can be found at www.pepperl-fuchs.com

Curves/Diagrams

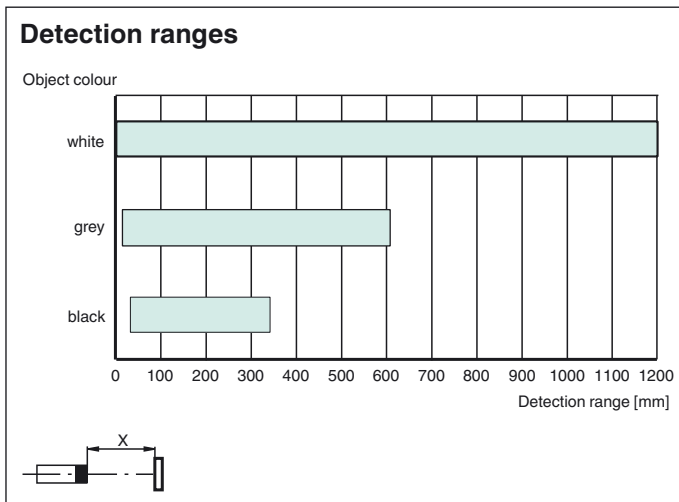
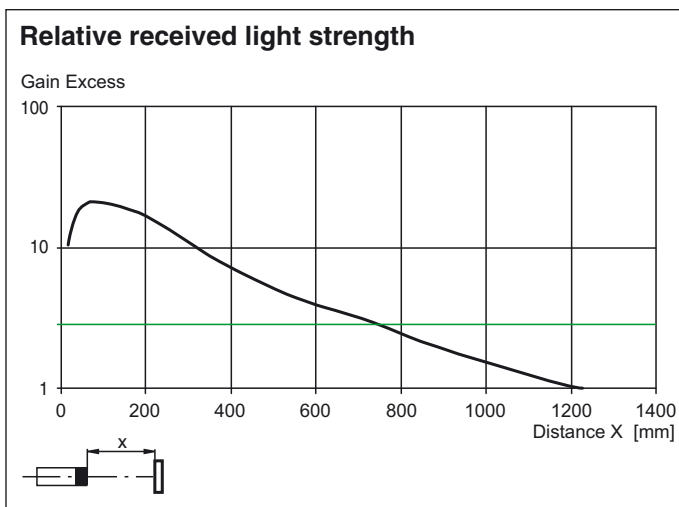
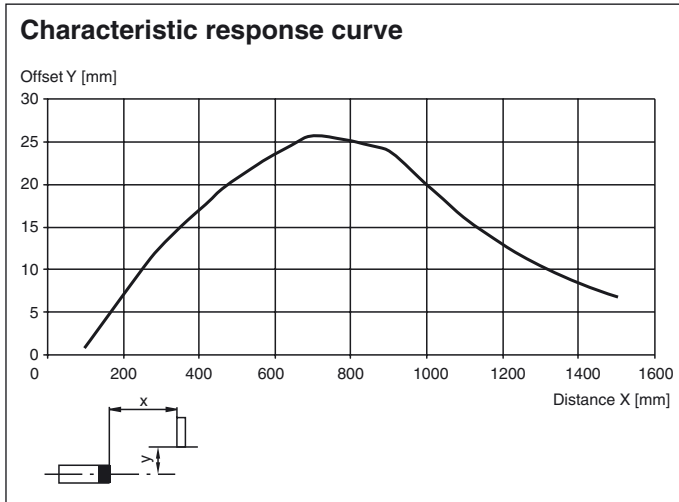

Release date: 2014-05-08 14:32 Date of issue: 2014-05-08 186473_eng.xml

Refer to "General Notes Relating to Pepperl+Fuchs Product Information".