

LQH32MN330J23#

“#” indicates a package specification code.

Size Code 3225 (1210) in mm (in inch)



< List of part numbers with package codes >

LQH32MN330J23K LQH32MN330J23L

Appearance & Shape

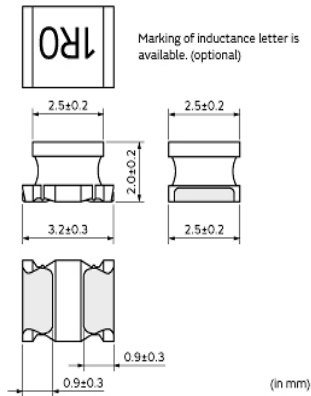

References

Packaging	Specifications	Standard Packing Quantity
K	330Embossed Tape	7500
L	180Embossed Tape	2000

Mass (typ.)	
1 piece	0.06g

Attention

- 1.This datasheet is downloaded from the website of Murata Manufacturing Co., Ltd. Therefore, it's specifications are subject to change or our products in it may be discontinued without advance notice. Please check with our sales representatives or product engineers before ordering.
- 2.This datasheet has only typical specifications because there is no space for detailed specifications. Therefore, please review our product specifications or consult the approval sheet for product specifications before ordering.

LQH32MN330J23#

“#” indicates a package specification code.



Specifications

L size	3.2±0.3mm
W size	2.5±0.2mm
T size	2.0±0.2mm
Size code inch (mm)	1210 (3225)
Inductance	33μH±5%
Inductance Test Frequency	1MHz
Rated current (Itemp) (Based on Temperature rise)	115mA
Max. of DC resistance	3.5Ω
Class of magnetic shield	No Shield
Q(min.)	40
Q Test Frequency	1MHz
Self resonance frequency (min.)	12MHz
Operating Temperature Range(Self-temperature rise is not included)	-40°C to 85°C
Series	LQH32MN_23

Attention

1.This datasheet is downloaded from the website of Murata Manufacturing Co., Ltd. Therefore, it's specifications are subject to change or our products in it may be discontinued without advance notice. Please check with our sales representatives or product engineers before ordering.

2.This datasheet has only typical specifications because there is no space for detailed specifications.

Therefore, please review our product specifications or consult the approval sheet for product specifications before ordering.

LQH32MN330J23#

“#” indicates a package specification code.

Characteristic Data

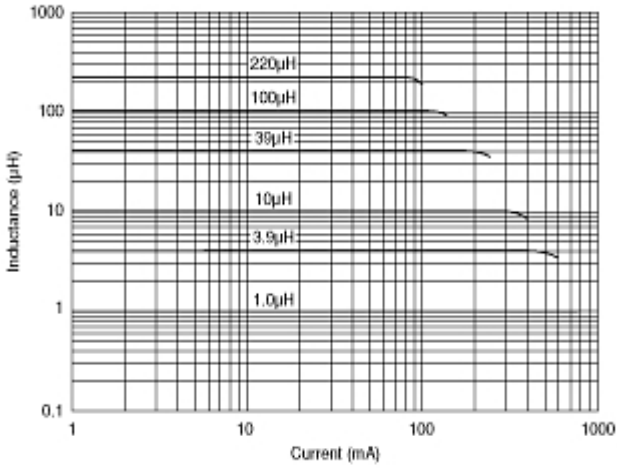

Impedance - Current Characteristics

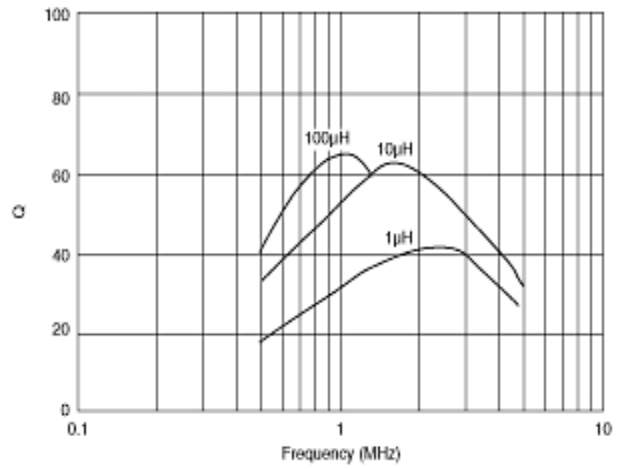

Q-Frequency Characteristics

Attention

- 1.This datasheet is downloaded from the website of Murata Manufacturing Co., Ltd. Therefore, it's specifications are subject to change or our products in it may be discontinued without advance notice. Please check with our sales representatives or product engineers before ordering.
- 2.This datasheet has only typical specifications because there is no space for detailed specifications. Therefore, please review our product specifications or consult the approval sheet for product specifications before ordering.