

F97-HT3 Series



High Temperature 135°C, Resin-molded Chip, High Reliability



FEATURES

- High temperature 135°C
- AEC-Q200 qualified
- Failure rate level 0.5%/ 1000 hrs



APPLICATIONS

- Automotive electronics (Engine ECU, Transmission, Oil pump)
- Industrial equipment

CASE DIMENSIONS: millimeters (inches)

Code	EIA Code	EIA Metric	L	W ₁	W ₂	H	S
A	1206	3216-18	3.20 ± 0.20 (0.126 ± 0.008)	1.60 ± 0.20 (0.063 ± 0.008)	1.20 ± 0.10 (0.047 ± 0.004)	1.60 ± 0.20 (0.063 ± 0.008)	0.80 ± 0.20 (0.031 ± 0.008)
B	1210	3528-21	3.50 ± 0.20 (0.138 ± 0.008)	2.80 ± 0.20 (0.110 ± 0.008)	2.20 ± 0.10 (0.087 ± 0.004)	1.90 ± 0.20 (0.075 ± 0.008)	0.80 ± 0.20 (0.031 ± 0.008)
C	2312	6032-27	6.00 ± 0.20 (0.236 ± 0.008)	3.20 ± 0.20 (0.126 ± 0.008)	2.20 ± 0.10 (0.087 ± 0.004)	2.50 ± 0.20 (0.098 ± 0.008)	1.30 ± 0.20 (0.051 ± 0.008)
N	2917	7343-30	7.30 ± 0.20 (0.287 ± 0.008)	4.30 ± 0.20 (0.169 ± 0.008)	2.40 ± 0.10 (0.094 ± 0.004)	2.80 ± 0.20 (0.110 ± 0.008)	1.30 ± 0.20 (0.051 ± 0.008)

A, B CASE

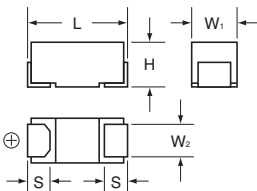

C, N CASE

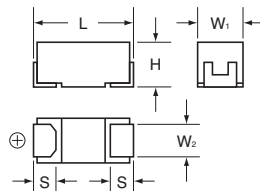

MARKING

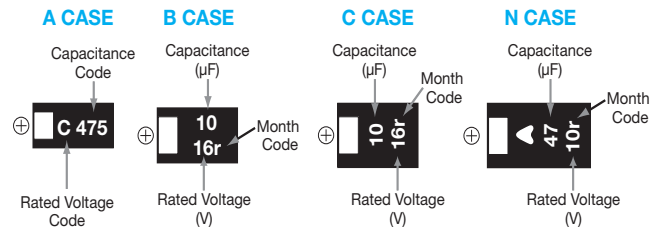

HOW TO ORDER

F97	1C	335	M	A		HT3
Type	Rated Voltage	Capacitance Code	Tolerance	Case Size	Packaging	Temperature Range
		pF code: 1st two digits represent significant figures, 3rd digit represents multiplier (number of zeros to follow)	K = ±10% M = ±20%	See table above	See Tape & Reel Packaging Section	135°C MAX

TECHNICAL SPECIFICATIONS

Category Temperature Range:	-55 to +135°C
Rated Temperature:	+95°C
Capacitance Tolerance:	±20%, ±10% at 120Hz
Dissipation Factor:	Refer to next page
ESR 100kHz:	Refer to next page
Leakage Current*:	After 1 minute's application of rated voltage, leakage current at 20°C is not more than 0.01CV or 0.5µA, whichever is greater. After 1 minute's application of rated voltage, leakage current at 95°C is not more than 0.1CV or 5µA, whichever is greater. After 1 minute's application of derated voltage, leakage current at 135°C is not more than 0.125CV or 6.3µA, whichever is greater.
Capacitance Change By Temperature	+15% Max. at +135°C +10% Max. at +95°C -10% Max. at -55°C

*As for the surge voltage and derated voltage at 135°C, refer to page precautions for details.



F97-HT3 Series



High Temperature 135°C, Resin-molded Chip, High Reliability

CAPACITANCE AND RATED VOLTAGE RANGE (LETTER DENOTES CASE SIZE)

Capacitance		Rated Voltage					
μF	Code	6.3V (0J)	10V (1A)	16V (1C)	20V (1D)	25V (1E)	35V (1V)
0.33	334						A
0.47	474						A
0.68	684				A	A	A
1	105			A	A	A	B
1.5	155			A	A		B
2.2	225		A	A	A	B	B
3.3	335	A	A	A	B	B	C
4.7	475	A	A/B	A/B	A/B	C	C
6.8	685	A/B	B	B	C	C	N
10	106		A/B	A/B/C	C	C/N	N
15	156	B	A/B	C	N	N	
22	226	A/B	A/B	B/C/N	C/N		
33	336	A/C	B/C/N	B/C/N			
47	476	B/C	B/C/N	C/N			
68	686	N	N				
100	107	N	C				

Released ratings

Please contact to your local AVX sales office when these series are being designed in your application.

Voltage vs Temperature Rating

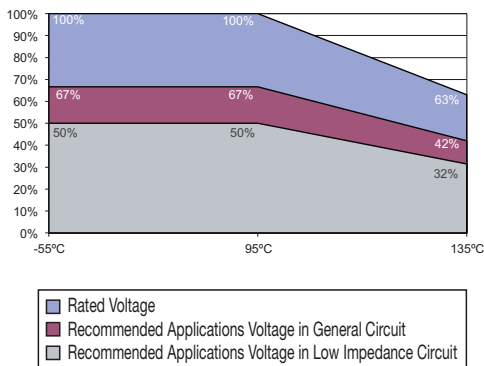

F97-HT3 Series



High Temperature 135°C, Resin-molded Chip, High Reliability

RATINGS & PART NUMBER REFERENCE

AVX Part No.	Case Size	Capacitance (µF)	Rated Voltage (V)	Leakage Current (µA)	DF @ 120Hz (%)	ESR @ 100kHz (Ω)	100kHz RMS Current (mA)			*1 ΔC/C (%)	MSL
							25°C	95°C	135°C		
6.3 Volt											
F970J335#AAHT3	A	3.3	6.3	0.5	4	4.5	129	116	52	*	3
F970J475#AAHT3	A	4.7	6.3	0.5	6	4.0	137	123	55	*	3
F970J685#AAHT3	A	6.8	6.3	0.5	6	3.5	146	132	59	*	3
F970J685#BAHT3	B	6.8	6.3	0.5	6	2.5	184	166	74	*	3
F970J156#BAHT3	B	15	6.3	0.9	6	2.0	206	186	82	*	3
F970J226#AAHT3	A	22	6.3	1.4	12	2.5	173	156	69	*	3
F970J226#BAHT3	B	22	6.3	1.4	8	1.9	212	190	85	*	3
F970J336#AAHT3	A	33	6.3	2.1	12	2.5	173	156	69	*	3
F970J336#CCHT3	C	33	6.3	2.1	6	1.1	316	285	126	*	3
F970J476#BAHT3	B	47	6.3	3.0	8	1.0	292	262	117	*	3
F970J476#CCHT3	C	47	6.3	3.0	6	0.9	350	315	140	*	3
F970J686#NCHT3	N	68	6.3	4.3	6	0.6	500	450	200	*	3
F970J107#NCHT3	N	100	6.3	6.3	8	0.6	500	450	200	*	3
10 Volt											
F971A225#AAHT3	A	2.2	10	0.5	4	5.0	122	110	49	*	3
F971A335#AAHT3	A	3.3	10	0.5	4	4.5	129	116	52	*	3
F971A475#AAHT3	A	4.7	10	0.5	6	4.0	137	123	55	*	3
F971A475#BAHT3	B	4.7	10	0.5	6	2.8	174	157	70	*	3
F971A685#BAHT3	B	6.8	10	0.7	6	2.5	184	166	74	*	3
F971A106#AAHT3	A	10	10	1.0	6	3.0	158	142	63	*	3
F971A106#BAHT3	B	10	10	1.0	6	2.0	206	186	82	*	3
F971A156#AAHT3	A	15	10	1.5	10	3.0	158	142	63	*	3
F971A156#BAHT3	B	15	10	1.5	6	2.0	206	186	82	*	3
F971A226#AAHT3	A	22	10	2.2	15	3.0	158	142	63	*	3
F971A226#BAHT3	B	22	10	2.2	8	1.9	212	190	85	*	3
F971A336#BAHT3	B	33	10	3.3	8	1.9	212	190	85	*	3
F971A336#CCHT3	C	33	10	3.3	6	1.1	316	285	126	*	3
F971A336#NCHT3	N	33	10	3.3	6	0.7	463	417	185	*	3
F971A476#BAHT3	B	47	10	4.7	10	1.0	292	262	117	*	3
F971A476#CCHT3	C	47	10	4.7	8	0.9	350	315	140	*	3
F971A476#NCHT3	N	47	10	4.7	6	0.7	463	417	185	*	3
F971A686#NCHT3	N	68	10	6.8	6	0.6	500	450	200	*	3
F971A107#CCHT3	C	100	10	10.0	10	0.7	396	357	159	*	3
16 Volt											
F971C105#AAHT3	A	1	16	0.5	4	7.5	100	90	40	*	3
F971C155#AAHT3	A	1.5	16	0.5	4	6.3	109	98	44	*	3
F971C225#AAHT3	A	2.2	16	0.5	4	5.0	122	110	49	*	3
F971C335#AAHT3	A	3.3	16	0.5	4	4.5	129	116	52	*	3
F971C475#AAHT3	A	4.7	16	0.8	8	4.0	137	123	55	*	3
F971C475#BAHT3	B	4.7	16	0.8	6	2.8	174	157	70	*	3
F971C685#BAHT3	B	6.8	16	1.1	6	2.5	184	166	74	*	3
F971C106#AAHT3	A	10	16	1.6	8	3.5	146	132	59	*	3
F971C106#BAHT3	B	10	16	1.6	6	2.1	201	181	80	*	3
F971C106#CCHT3	C	10	16	1.6	6	1.5	271	244	108	*	3
F971C156#CCHT3	C	15	16	2.4	6	1.2	303	272	121	*	3
F971C226#BAHT3	B	22	16	3.5	8	1.9	212	190	85	*	3
F971C226#CCHT3	C	22	16	3.5	8	1.1	316	285	126	*	3
F971C226#NCHT3	N	22	16	3.5	6	0.7	463	417	185	*	3
F971C336#BAHT3	B	33	16	5.3	10	2.1	201	181	80	*	3
F971C336#CCHT3	C	33	16	5.3	8	1.1	316	285	126	*	3
F971C336#NCHT3	N	33	16	5.3	6	0.7	463	417	185	*	3
F971C476#CCHT3	C	47	16	7.5	10	1.1	316	285	126	*	3
F971C476#NCHT3	N	47	16	7.5	8	0.7	463	417	185	*	3
20 Volt											
F971D684#AAHT3	A	0.68	20	0.5	4	7.6	99	89	40	*	3
F971D105#AAHT3	A	1	20	0.5	4	7.5	100	90	40	*	3
F971D155#AAHT3	A	1.5	20	0.5	4	6.7	106	95	42	*	3
F971D225#AAHT3	A	2.2	20	0.5	6	6.3	109	98	44	*	3
F971D335#BAHT3	B	3.3	20	0.7	4	3.1	166	149	66	*	3
F971D475#AAHT3	A	4.7	20	0.9	8	4.0	137	123	55	*	3
F971D475#BAHT3	B	4.7	20	0.9	6	2.8	174	157	70	*	3
F971D685#CCHT3	C	6.8	20	1.4	6	1.8	247	222	99	*	3
F971D106#CCHT3	C	10	20	2.0	6	1.5	271	244	108	*	3
F971D156#NCHT3	N	15	20	3.0	6	0.7	463	417	185	*	3
F971D226#CCHT3	C	22	20	4.4	8	1.1	316	285	126	*	3
F971D226#NCHT3	N	22	20	4.4	6	0.7	463	417	185	*	3
25 Volt											
F971E684#AAHT3	A	0.68	25	0.5	4	7.6	99	89	40	*	3
F971E105#AAHT3	A	1	25	0.5	4	7.5	100	90	40	*	3
F971E225#BAHT3	B	2.2	25	0.6	4	3.8	150	135	60	*	3
F971E335#BAHT3	B	3.3	25	0.8	4	3.5	156	140	62	*	3
F971E475#CCHT3	C	4.7	25	1.2	6	1.8	247	222	99	*	3
F971E685#CCHT3	C	6.8	25	1.7	6	1.8	247	222	99	*	3

F97-HT3 Series



High Temperature 135°C, Resin-molded Chip, High Reliability

RATINGS & PART NUMBER REFERENCE

AVX Part No.	Case Size	Capacitance (μF)	Rated Voltage (V)	Leakage Current (μA)	DF @ 120Hz (%)	ESR @ 100kHz (Ω)	100kHz RMS Current (mA)			*1 ΔC/C (%)	MSL
							25°C	95°C	135°C		
F971E106#CCHT3	C	10	25	2.5	6	1.6	262	236	105	*	3
F971E106#NCHT3	N	10	25	2.5	6	1.0	387	349	155	*	3
F971E156#NCHT3	N	15	25	3.8	6	0.7	463	417	185	*	3
35 Volt											
F971V334#AAHT3	A	0.33	35	0.5	4	12.0	79	71	32	*	3
F971V474#AAHT3	A	0.47	35	0.5	4	10.0	87	78	35	*	3
F971V684#AAHT3	A	0.68	35	0.5	4	7.6	99	89	40	*	3
F971V105#BAHT3	B	1	35	0.5	4	4.0	146	131	58	*	3
F971V155#BAHT3	B	1.5	35	0.5	4	4.0	146	131	58	*	3
F971V225#BAHT3	B	2.2	35	0.8	4	3.8	150	135	60	*	3
F971V335#CCHT3	C	3.3	35	1.2	4	2.0	235	211	94	*	3
F971V475#CCHT3	C	4.7	35	1.6	6	1.8	247	222	99	*	3
F971V685#NCHT3	N	6.8	35	2.4	6	1.0	387	349	155	*	3
F971V106#NCHT3	N	10	35	3.5	6	1.0	387	349	155	*	3

1: ΔC/C Marked “”

#: “M” for ±20% tolerance, “K” for ± 10% tolerance.

Moisture Sensitivity Level (MSL) is defined according to J-STD-020.

Item	All Case (%)
Damp Heat	±10
Temperature cycles	±5
Resistance soldering heat	±5
Surge	±5
Endurance	±10
Load Humidity	±10

QUALIFICATION TABLE

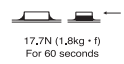
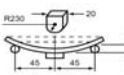
TEST	F97-HT3 series (Temperature range -55°C to +135°C)	
	Condition	
Damp Heat (Steady State)	At 85°C, 85% RH For 1000 hours (No voltage applied) Capacitance Change....Refer to page 115 (*1) Dissipation Factor Initial specified value or less Leakage Current 125% or less than the initial specified value	
Load Humidity	After 1000 hours application of rated voltage in series with a 33Ω resistor at 85°C, 85% RH capacitors meet the characteristics requirements table below. Capacitance Change ...Refer to page 115 (*1) Dissipation Factor120% or less than the Initial specified value Leakage Current.....200% or less than the initial specified value	
Temperature Cycles	At -55°C / +135°C, For 30 minutes each, 1000 cycles Capacitance Change ...Refer to page 115 (*1) Dissipation FactorInitial specified value or less Leakage Current.....Initial specified value or less	
Resistance to Soldering Heat	10 seconds reow at 260°C, 5 seconds immersion at 260°C. Capacitance Change ...Refer to page 115 (*1) Dissipation FactorInitial specified value or less Leakage Current.....Initial specified value or less	
Solderability	After immersing capacitors completely into a solder pot at 245°C for 2 to 3 seconds, more than 3/4 of their electrode area shall remain covered with new solder.	
Surge*	After application of surge in series with a 33Ω resistor at the rate of 30 seconds ON, 30 seconds OFF, for 1000 successive test cycles at 95°C, capacitors shall meet the characteristic requirements table below. Capacitance Change ...Refer to page 115 (*1) Dissipation FactorInitial specified value or less Leakage Current.....Initial specified value or less	
Endurance*	After 2000 hours application of rated voltage in series with a 3Ω resistor at 95°C, or derated voltage in series with a 3Ω resistor at 135°C, capacitors shall meet the characteristic requirements table below. Capacitance Change ...Refer to page 115 (*1) Dissipation FactorInitial specified value or less Leakage Current.....Initial specified value or less	
Shear Test	After applying the pressure load of 17.7N for 60 seconds horizontally to the center of capacitor side body which has no electrode and has been soldered beforehand on a substrate, there shall be found neither exfoliation nor its sign at the terminal electrode.	
Terminal Strength	Keeping a capacitor surface-mounted on a substrate upside down and supporting the substrate at both of the opposite bottom points 45mm apart from the center of capacitor, the pressure strength is applied with a specified jig at the center of the substrate so that substrate may bend by 1mm as illustrated. Then, there shall be found no remarkable abnormality on the capacitor terminals.	

* As for the surge voltage and derated voltage at 135°C, refer to page precautions for details.

F97-HT3 Series



High Temperature 135°C, Resin-molded Chip, High Reliability

AVX SOLID ELECTROLYTIC CAPACITOR ROADMAP

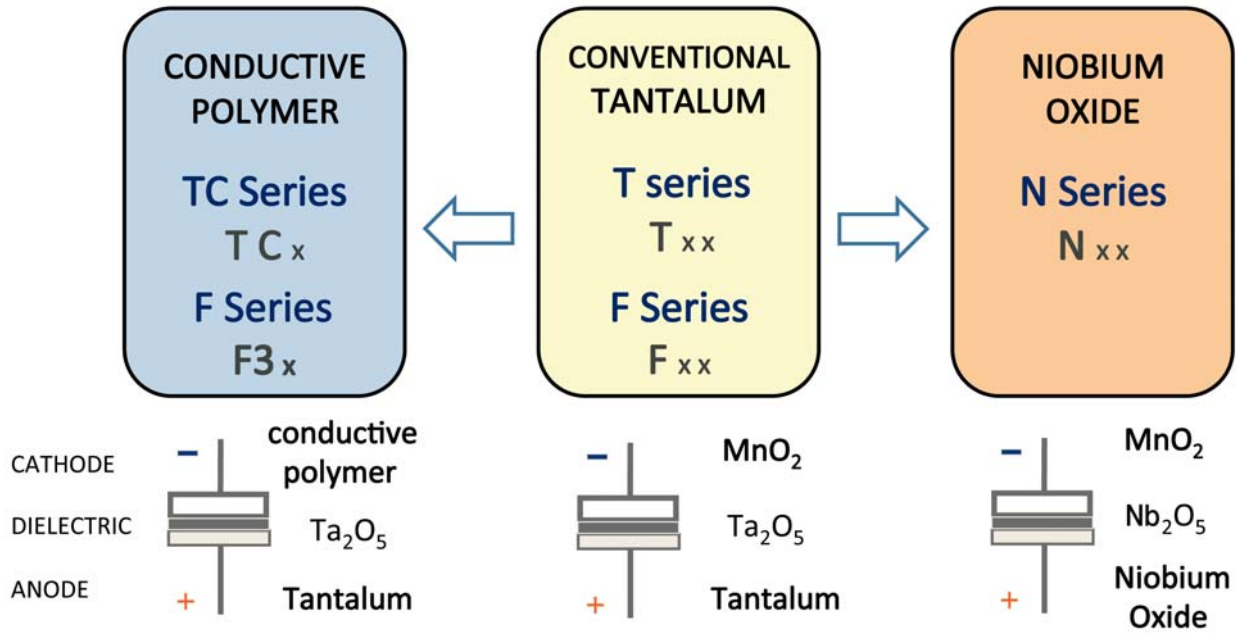

Five Capacitor Construction Styles

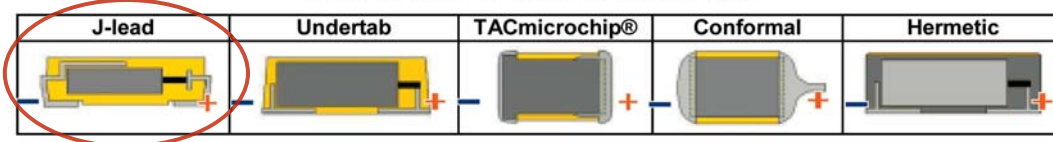

SERIES LINE UP: CONVENTIONAL SMD MnO₂

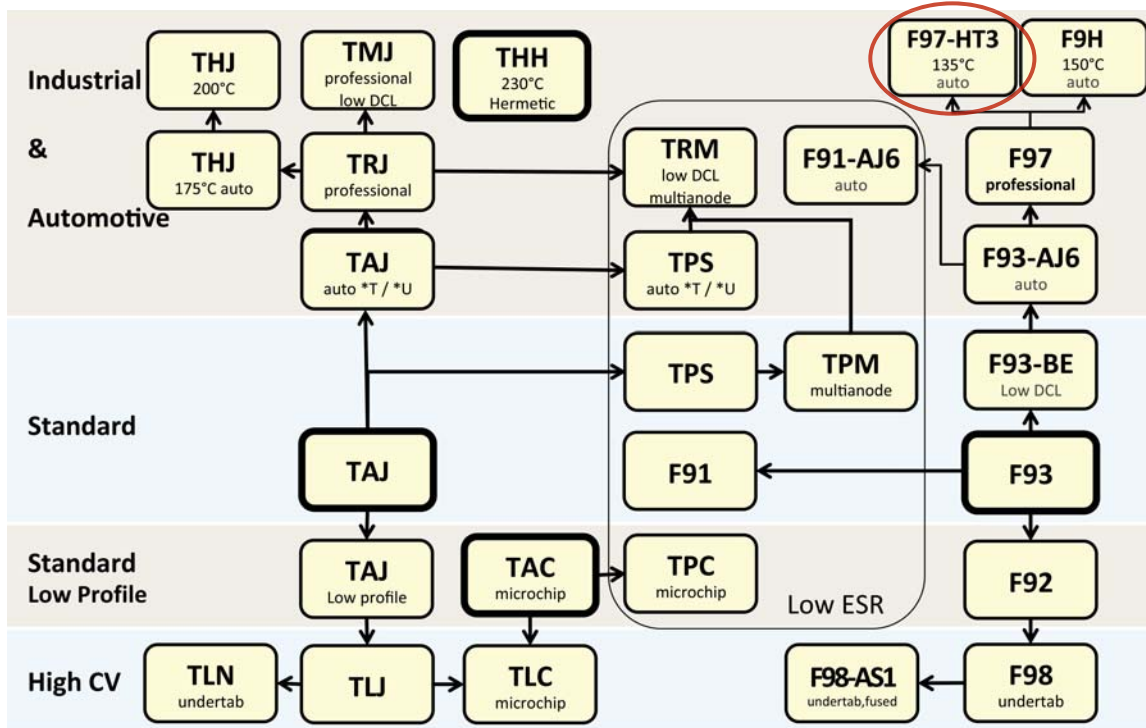

Mouser Electronics

Authorized Distributor

Click to View Pricing, Inventory, Delivery & Lifecycle Information:

AVX:

[F971C336MBAHT3](#) [F971C106MAAHT3](#) [F971A336MCCHT3](#) [F970J107MNCHT3](#) [F971D226MNCHT3](#)
[F971C226MNCHT3](#) [F971A226MBAHT3](#) [F971C336MCCHT3](#) [F971D685MCCHT3](#) [F970J336MAAHT3](#)
[F971A475MAAHT3](#) [F971C106MCCHT3](#) [F970J476MBAHT3](#) [F970J226MAAHT3](#) [F971A476MNCHT3](#)
[F971E106MNCHT3](#) [F971D475MAAHT3](#) [F971A476MCCHT3](#) [F970J685MBAHT3](#) [F970J475MAAHT3](#)
[F971A686MNCHT3](#) [F971C336MNCHT3](#) [F971V334MAAHT3](#) [F971D225MAAHT3](#) [F971V225MBAHT3](#)
[F971V106MNCHT3](#) [F970J335MAAHT3](#) [F971E685MCCHT3](#) [F971E335MBAHT3](#) [F971A336MBAHT3](#)
[F970J156MBAHT3](#) [F971A335MAAHT3](#) [F971C156MCCHT3](#) [F970J685MAAHT3](#) [F971C475MAAHT3](#)
[F971E475MCCHT3](#) [F971C225MAAHT3](#) [F971A156MBAHT3](#) [F971C475MBAHT3](#) [F971E156MNCHT3](#)
[F971E106MCCHT3](#) [F971V684MAAHT3](#) [F971A106MBAHT3](#) [F971C685MBAHT3](#) [F971C106MBAHT3](#)
[F971C476MCCHT3](#) [F971D155MAAHT3](#) [F971A226MAAHT3](#) [F971E684MAAHT3](#) [F971D105MAAHT3](#)
[F971C335MAAHT3](#) [F971A336MNCHT3](#) [F971A106MAAHT3](#) [F971C226MBAHT3](#) [F971A156MAAHT3](#)
[F971D226MCCHT3](#) [F970J226MBAHT3](#) [F971D106MCCHT3](#) [F971D156MNCHT3](#) [F971E225MBAHT3](#)
[F971C105MAAHT3](#) [F971V155MBAHT3](#) [F971C226MCCHT3](#) [F971D684MAAHT3](#) [F970J476MCCHT3](#)
[F971V474MAAHT3](#) [F971V475MCCHT3](#) [F970J686MNCHT3](#) [F971C476MNCHT3](#) [F970J336MCCHT3](#)
[F971E105MAAHT3](#) [F971V685MNCHT3](#) [F971D335MBAHT3](#) [F971V105MBAHT3](#) [F971A685MBAHT3](#)
[F971A475MBAHT3](#) [F971D475MBAHT3](#) [F971V335MCCHT3](#) [F971A225MAAHT3](#) [F971C155MAAHT3](#)
[F971A107MCCHT3](#) [F971A476MBAHT3](#)