

N- and P-Channel 30-V (D-S) MOSFET

- ▼ Simple Drive Requirement
- ▼ Lower Gate Charge
- ▼ Fast Switching Performance
- ▼ RoHS Compliant & Halogen-Free

N-CH	BV_{DSS}	30V
	$R_{DS(ON)}$	22m Ω
	I_D	6.2A
P-CH	BV_{DSS}	-30V
	$R_{DS(ON)}$	45m Ω
	I_D	-5.0A

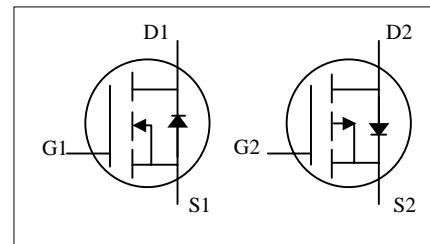
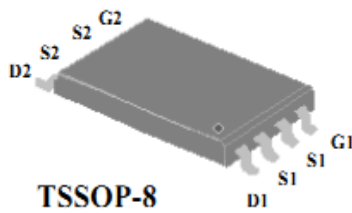

Absolute Maximum Ratings

Symbol	Parameter	Rating		Units
		N-channel	P-channel	
V_{DS}	Drain-Source Voltage	30	-30	V
V_{GS}	Gate-Source Voltage	± 20	± 20	V
$I_D@T_A=25^\circ C$	Continuous Drain Current ³	6.2	-5.0	A
$I_D@T_A=70^\circ C$	Continuous Drain Current ³	5.0	-4.0	A
I_{DM}	Pulsed Drain Current ¹	20	-18	A
$P_D@T_A=25^\circ C$	Total Power Dissipation	1.35		W
T_{STG}	Storage Temperature Range	-55 to 150		$^\circ C$
T_J	Operating Junction Temperature Range	-55 to 150		$^\circ C$

Thermal Data

Symbol	Parameter	Value	Unit
Rthj-a	Maximum Thermal Resistance, Junction-ambient ³	90	$^\circ C/W$

N-CH Electrical Characteristics @ $T_j=25^{\circ}\text{C}$ (unless otherwise specified)

Symbol	Parameter	Test Conditions	Min.	Typ.	Max.	Units
BV_{DSS}	Drain-Source Breakdown Voltage	$V_{GS}=0V, I_D=250\mu A$	30	-	-	V
$R_{DS(ON)}$	Static Drain-Source On-Resistance ²	$V_{GS}=10V, I_D=6A$	-	22	-	m Ω
		$V_{GS}=4.5V, I_D=4A$	-	30	-	m Ω
$V_{GS(th)}$	Gate Threshold Voltage	$V_{DS}=V_{GS}, I_D=250\mu A$	1	-	3	V
g_{fs}	Forward Transconductance	$V_{DS}=10V, I_D=6A$	-	14	-	S
I_{DSS}	Drain-Source Leakage Current	$V_{DS}=24V, V_{GS}=0V$	-	-	1	μA
I_{GSS}	Gate-Source Leakage	$V_{GS}=\pm 20V, V_{DS}=0V$	-	-	± 100	nA
Q_g	Total Gate Charge	$I_D=6A$	-	7	11	nC
Q_{gs}	Gate-Source Charge	$V_{DS}=15V$	-	2	-	nC
Q_{gd}	Gate-Drain ("Miller") Charge	$V_{GS}=4.5V$	-	4	-	nC
$t_{d(on)}$	Turn-on Delay Time	$V_{DS}=15V$	-	6	-	ns
t_r	Rise Time	$I_D=1A$	-	6	-	ns
$t_{d(off)}$	Turn-off Delay Time	$R_G=3.3\Omega$	-	17	-	ns
t_f	Fall Time	$V_{GS}=10V$	-	4	-	ns
C_{iss}	Input Capacitance	$V_{GS}=0V$	-	550	-	pF
C_{oss}	Output Capacitance	$V_{DS}=15V$	-	105	-	pF
C_{rss}	Reverse Transfer Capacitance	$f=1.0\text{MHz}$	-	90	-	pF
R_g	Gate Resistance	$f=1.0\text{MHz}$	-	1.7	-	Ω

Source-Drain Diode

Symbol	Parameter	Test Conditions	Min.	Typ.	Max.	Units
V_{SD}	Forward On Voltage ²	$I_S=1.2A, V_{GS}=0V$	-	-	1.2	V
t_{rr}	Reverse Recovery Time	$I_S=6A, V_{GS}=0V,$	-	15	-	ns
Q_{rr}	Reverse Recovery Charge	$di/dt=100A/\mu s$	-	7	-	nC

P-CH Electrical Characteristics @ $T_j=25^\circ\text{C}$ (unless otherwise specified)

Symbol	Parameter	Test Conditions	Min.	Typ.	Max.	Units
BV_{DSS}	Drain-Source Breakdown Voltage	$V_{GS}=0V, I_D=-250\mu A$	-30	-	-	V
$R_{DS(ON)}$	Static Drain-Source On-Resistance ²	$V_{GS}=-10V, I_D=-5A$	-	45	-	m Ω
		$V_{GS}=-4.5V, I_D=-3A$	-	66	-	m Ω
$V_{GS(th)}$	Gate Threshold Voltage	$V_{DS}=V_{GS}, I_D=-250\mu A$	-1	-	-3	V
g_{fs}	Forward Transconductance	$V_{DS}=-10V, I_D=-5A$	-	18	-	S
I_{DSS}	Drain-Source Leakage Current	$V_{DS}=-24V, V_{GS}=0V$	-	-	-1	μA
I_{GSS}	Gate-Source Leakage	$V_{GS}=\pm 20V, V_{DS}=0V$	-	-	+100	nA
Q_g	Total Gate Charge	$I_D=-5A$	-	14.4	23	nC
Q_{gs}	Gate-Source Charge	$V_{DS}=-15V$	-	5.5	-	nC
Q_{gd}	Gate-Drain ("Miller") Charge	$V_{GS}=-4.5V$	-	5	-	nC
$t_{d(on)}$	Turn-on Delay Time	$V_{DS}=-15V$	-	7	-	ns
t_r	Rise Time	$I_D=-1A$	-	6.5	-	ns
$t_{d(off)}$	Turn-off Delay Time	$R_G=3.3\Omega$	-	36	-	ns
t_f	Fall Time	$V_{GS}=-10V$	-	28	-	ns
C_{iss}	Input Capacitance	$V_{GS}=0V$	-	960	-	pF
C_{oss}	Output Capacitance	$V_{DS}=-15V$	-	190	-	pF
C_{rss}	Reverse Transfer Capacitance	$f=1.0\text{MHz}$	-	170	-	pF
R_g	Gate Resistance	$f=1.0\text{MHz}$	-	6	-	Ω

Source-Drain Diode

Symbol	Parameter	Test Conditions	Min.	Typ.	Max.	Units
V_{SD}	Forward On Voltage ²	$I_S=-1.2A, V_{GS}=0V$	-	-	-1.2	V
t_{rr}	Reverse Recovery Time	$I_S=-5A, V_{GS}=0V,$	-	19	-	ns
Q_{rr}	Reverse Recovery Charge	$dI/dt=100A/\mu s$	-	9	-	nC

Notes:

1. Pulse width limited by Max. junction temperature.
2. Pulse test
3. Surface mounted on 1 in² copper pad of FR4 board, $t \leq 10\text{sec}$; $208^\circ\text{C}/W$ when mounted on min. copper pad.

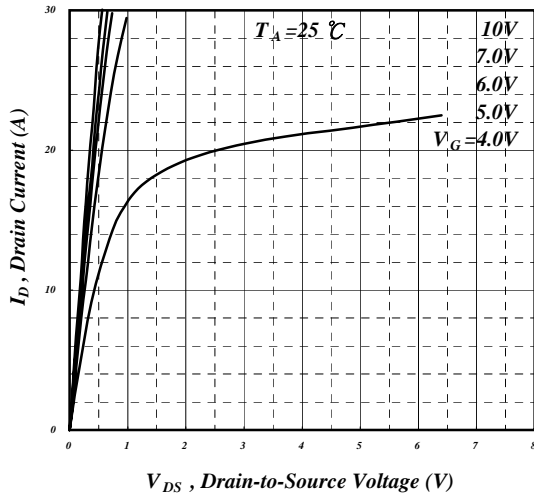

Fig 1. Typical Output Characteristics

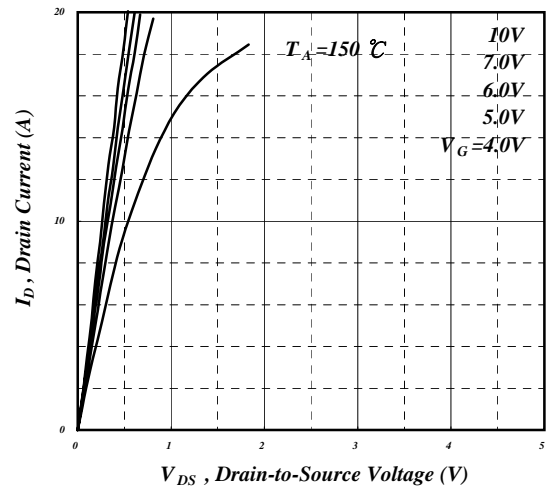

Fig 2. Typical Output Characteristics

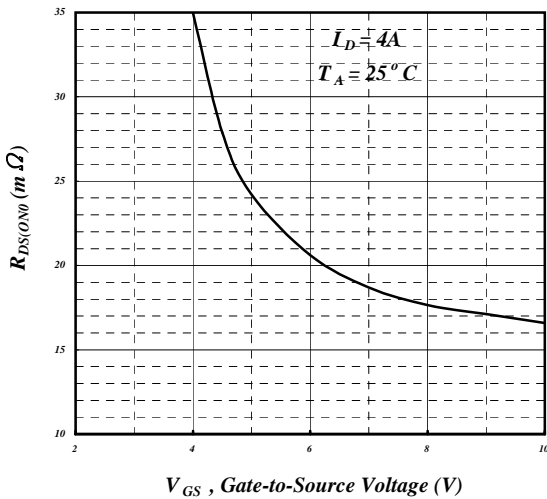

Fig 3. On-Resistance v.s. Gate Voltage

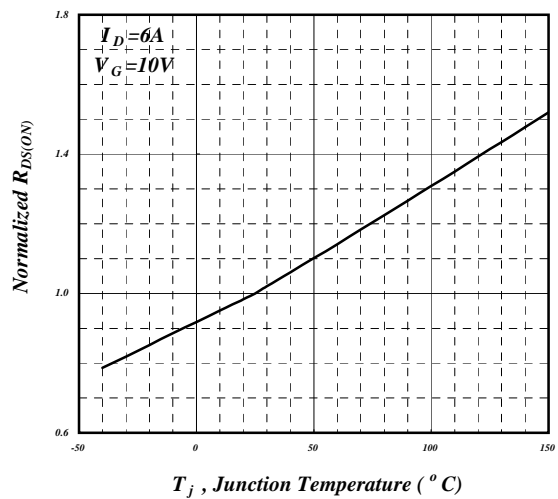

Fig 4. Normalized On-Resistance v.s. Junction Temperature

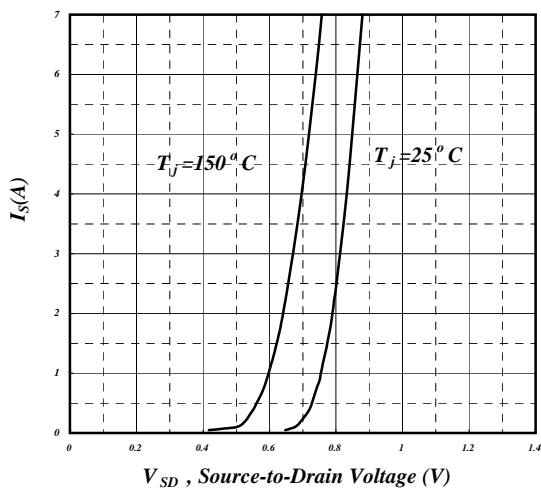

Fig 5. Forward Characteristic of Reverse Diode

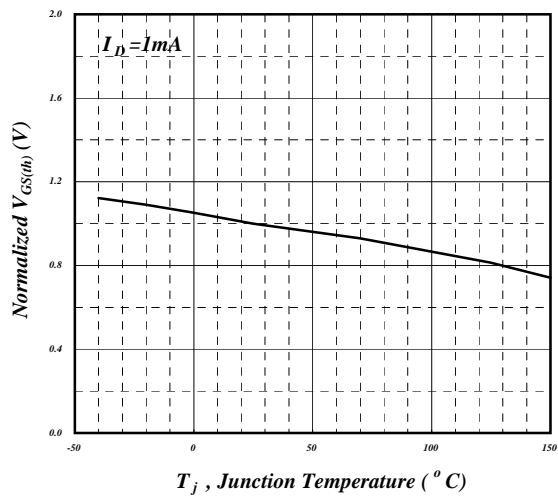

Fig 6. Gate Threshold Voltage v.s. Junction Temperature

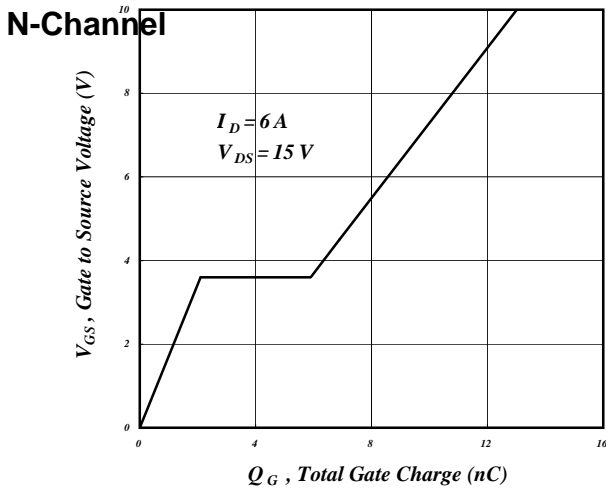

Fig 7. Gate Charge Characteristics

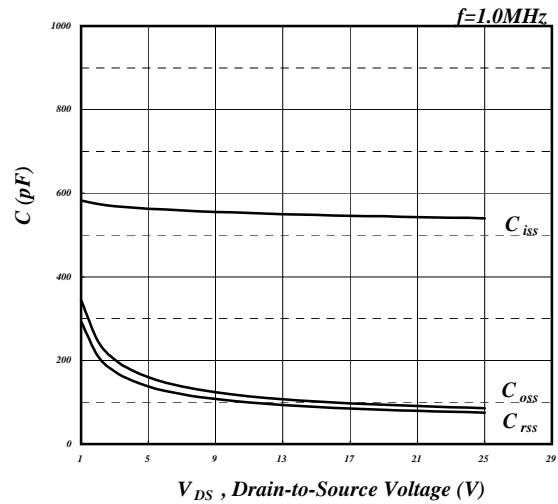

Fig 8. Typical Capacitance Characteristics

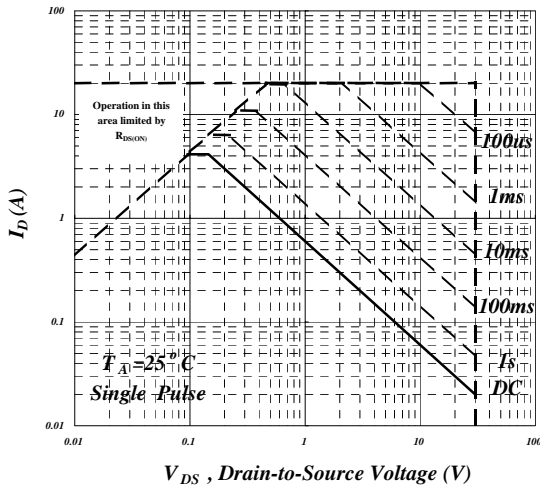

Fig 9. Maximum Safe Operating Area

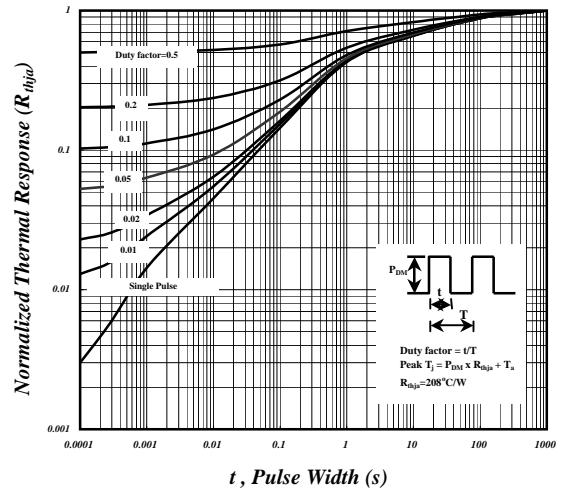

Fig 10. Effective Transient Thermal Impedance

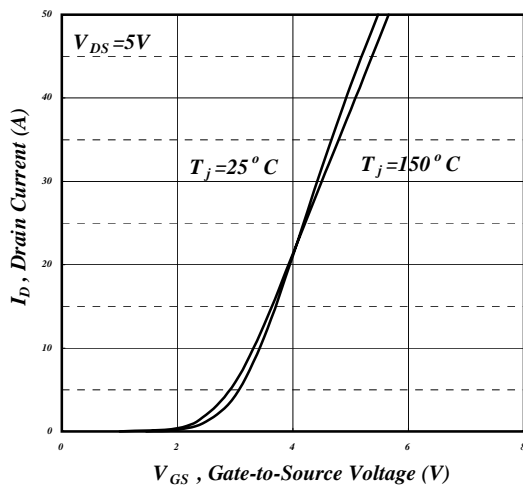

Fig 11. Transfer Characteristics

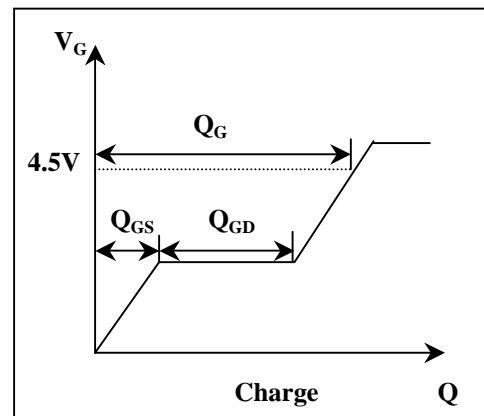

Fig 12. Gate Charge Waveform

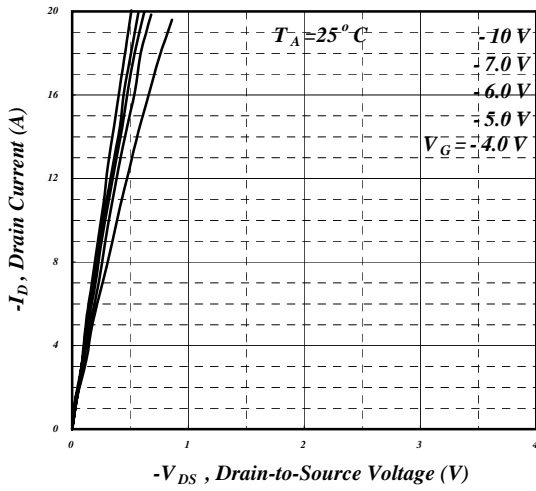

Fig 1. Typical Output Characteristics

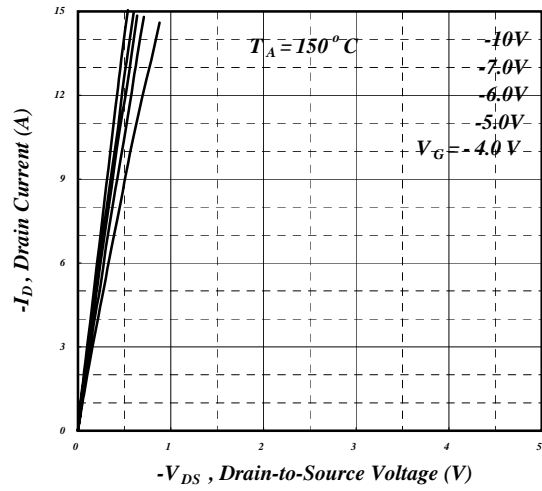

Fig 2. Typical Output Characteristics

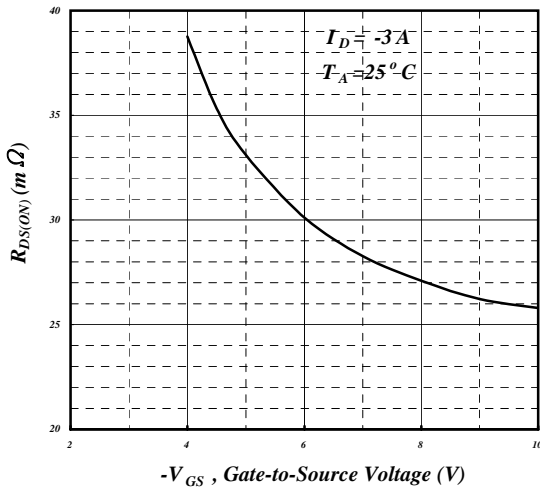

Fig 3. On-Resistance v.s. Gate Voltage

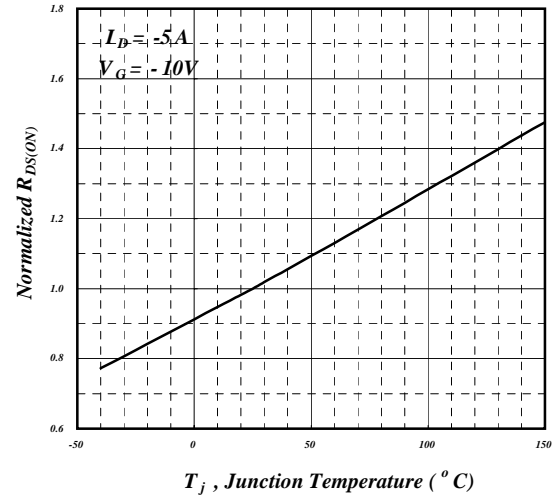

Fig 4. Normalized On-Resistance v.s. Junction Temperature

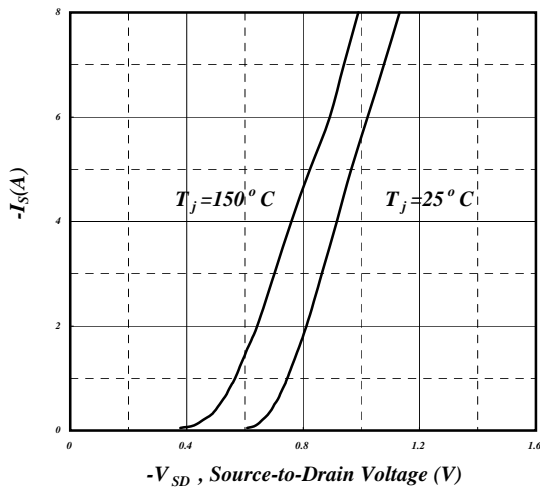

Fig 5. Forward Characteristic of Reverse Diode

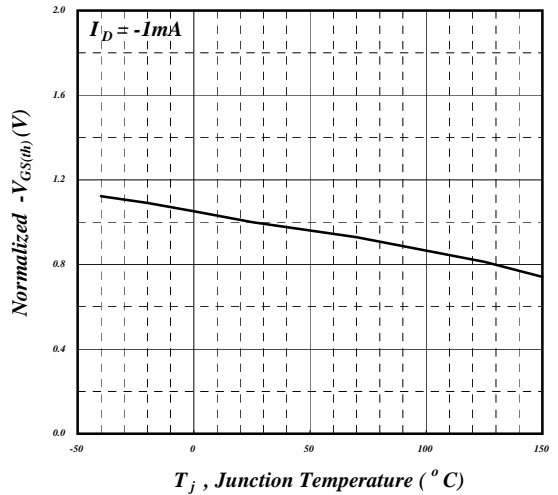

Fig 6. Gate Threshold Voltage v.s. Junction Temperature

P-Channel

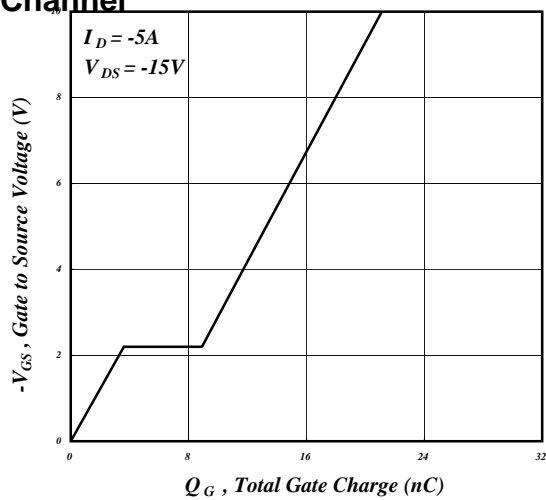

Fig 7. Gate Charge Characteristics

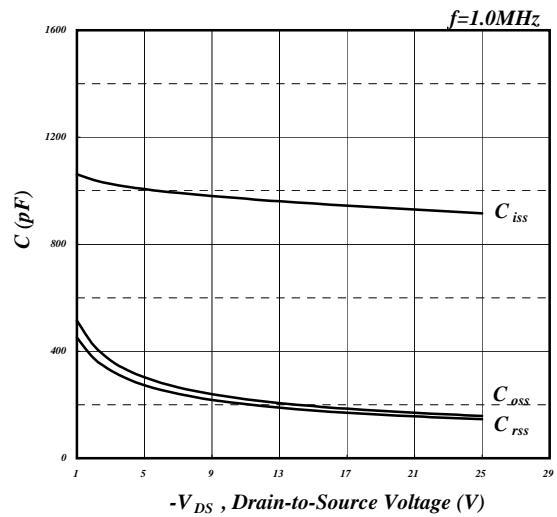

Fig 8. Typical Capacitance Characteristics

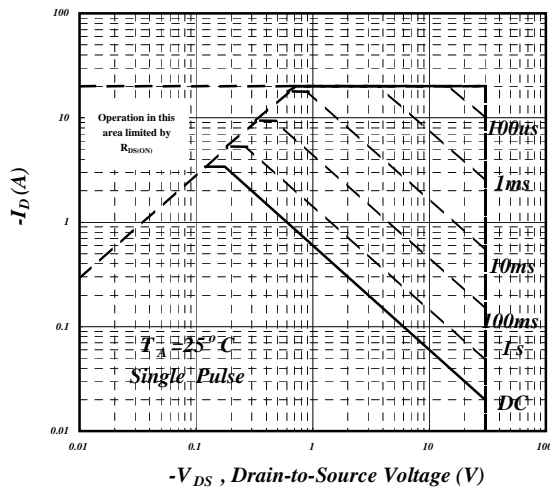

Fig 9. Maximum Safe Operating Area

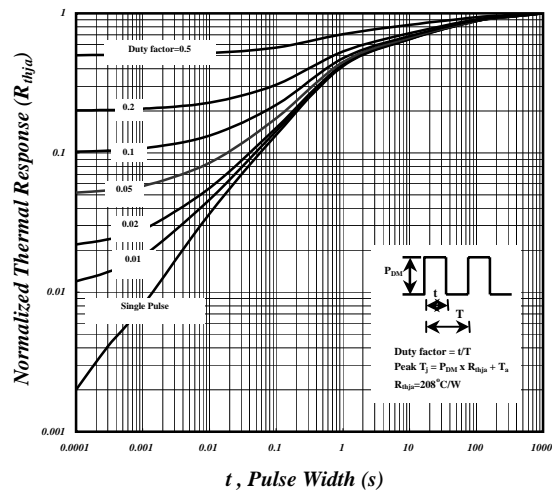

Fig 10. Effective Transient Thermal Impedance

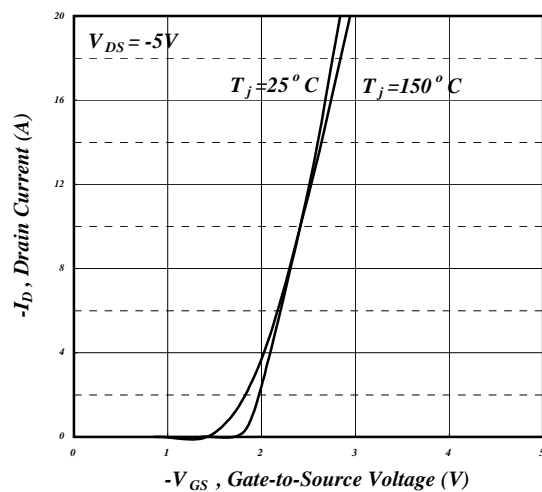

Fig 11. Transfer Characteristics

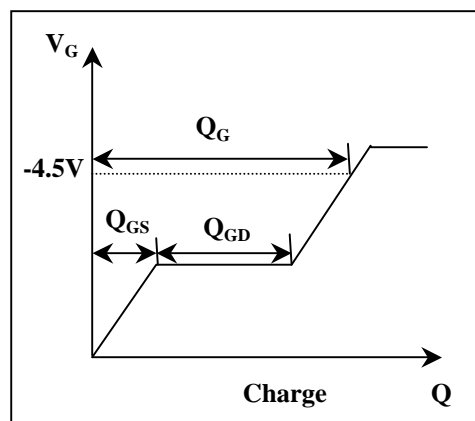
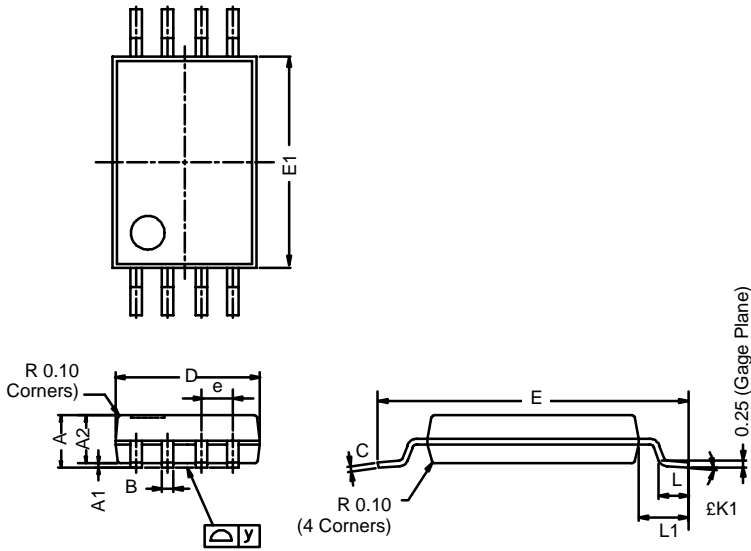

Fig 12. Gate Charge Waveform

TSSOP: 8-LEAD

JEDEC Part Number: MO-153



Dim	MILLIMETERS		
	Min	Nom	Max
A	–	–	1.20
A ₁	0.05	0.10	0.15
A ₂	0.80	1.00	1.05
B	0.19	0.28	0.30
C	–	0.127	–
D	2.90	3.00	3.10
E	6.20	6.40	6.60
E ₁	4.30	4.40	4.50
e	–	0.65	–
L	0.45	0.60	0.75
L ₁	0.90	1.00	1.10
Y	–	–	0.10
£K1	0°	3°	6°

ECN: S-03946—Rev. G, 09-Jul-01
DWG: 5844

Disclaimer

All products due to improve reliability, function or design or for other reasons, product specifications and data are subject to change without notice.

Taiwan VBsemi Electronics Co., Ltd., branches, agents, employees, and all persons acting on its or their representatives (collectively, the "Taiwan VBsemi"), assumes no responsibility for any errors, inaccuracies or incomplete data contained in the table or any other any disclosure of any information related to the product.(www.VBsemi.com)

Taiwan VBsemi makes no guarantee, representation or warranty on the product for any particular purpose of any goods or continuous production. To the maximum extent permitted by applicable law on Taiwan VBsemi relinquished: (1) any application and all liability arising out of or use of any products; (2) any and all liability, including but not limited to special, consequential damages or incidental ; (3) any and all implied warranties, including a particular purpose, non-infringement and merchantability guarantee.

Statement on certain types of applications are based on knowledge of the product is often used in a typical application of the general product VBsemi Taiwan demand that the Taiwan VBsemi of. Statement on whether the product is suitable for a particular application is non-binding. It is the customer's responsibility to verify specific product features in the products described in the specification is appropriate for use in a particular application. Parameter data sheets and technical specifications can be provided may vary depending on the application and performance over time. All operating parameters, including typical parameters must be made by customer's technical experts validated for each customer application. Product specifications do not expand or modify Taiwan VBsemi purchasing terms and conditions, including but not limited to warranty herein.

Unless expressly stated in writing, Taiwan VBsemi products are not intended for use in medical, life saving, or life sustaining applications or any other application. Wherein VBsemi product failure could lead to personal injury or death, use or sale of products used in Taiwan VBsemi such applications using client did not express their own risk. Contact your authorized Taiwan VBsemi people who are related to product design applications and other terms and conditions in writing.

The information provided in this document and the company's products without a license, express or implied, by estoppel or otherwise, to any intellectual property rights granted to the VBsemi act or document. Product names and trademarks referred to herein are trademarks of their respective representatives will be all.

Material Category Policy

Taiwan VBsemi Electronics Co., Ltd., hereby certify that all of the products are determined to be oHS compliant and meets the definition of restrictions under Directive of the European Parliament 2011/65 / EU, 2011 Nian. 6. 8 Ri Yue restrict the use of certain hazardous substances in electrical and electronic equipment (EEE) - modification, unless otherwise specified as inconsistent.(www.VBsemi.com)

Please note that some documents may still refer to Taiwan VBsemi RoHS Directive 2002/95 / EC. We confirm that all products identified as consistent with the Directive 2002/95 / EC European Directive 2011/65 /.

Taiwan VBsemi Electronics Co., Ltd. hereby certify that all of its products comply identified as halogen-free halogen-free standards required by the JEDEC JS709A. Please note that some Taiwanese VBsemi documents still refer to the definition of IEC 61249-2-21, and we are sure that all products conform to confirm compliance with IEC 61249-2-21 standard level JS709A.