

Chip Monolithic Ceramic Capacitors

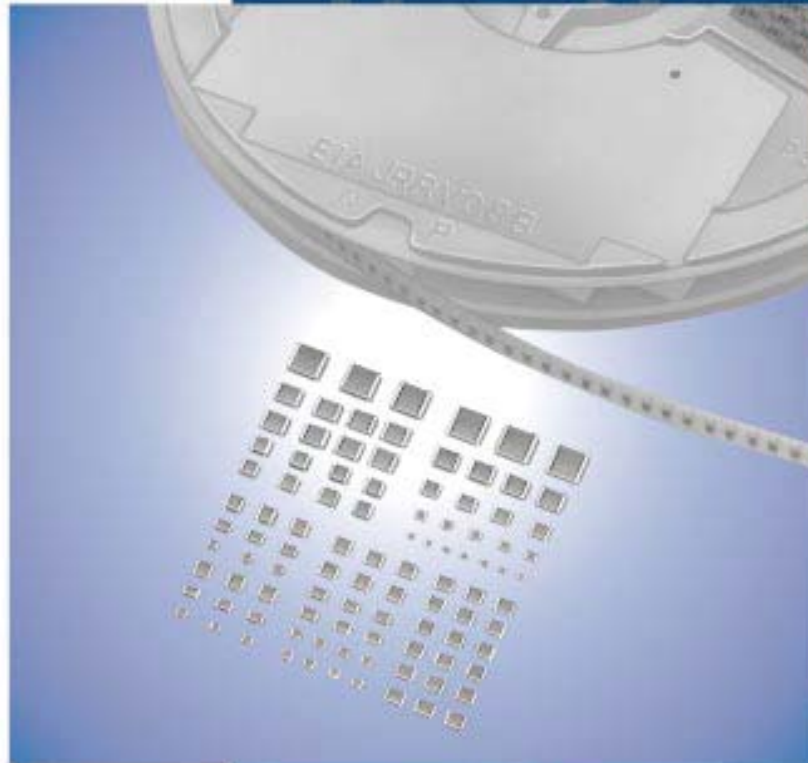

● Part Numbering

Chip Monolithic Ceramic Capacitors

(Part Number)

GR	M	18	8	B1	1H	102	K	A01	D
①	②	③	④	⑤	⑥	⑦	⑧	⑨	⑩

① Product ID

② Series

Product ID	Code	Series
GR	J	Soft Termination Type
	M	Tin Plated Layer
	4	Only for Information Devices / Tip & Ring
	7	Only for Camera Flash Circuit
GQ	M	High Frequency for Flow/Reflow Soldering
GM	A	Monolithic Microchip
	D	For Bonding
GN	M	Capacitor Array
LL	L	Low ESL Type
	R	Controlled ESR Low ESL Type
	A	8-termination Low ESL Type
	M	10-termination Low ESL Type
GJ	M	High Frequency Low Loss Type
GA	2	For AC250V (r.m.s.)
	3	Safety Standard Certified Type

③ Dimensions (L×W)

Code	Dimensions (L×W)	EIA
02	0.4×0.2mm	01005
03	0.6×0.3mm	0201
05	0.5×0.5mm	0202
08	0.8×0.8mm	0303
0D	0.38×0.38mm	015015
0M	0.9×0.6mm	0302
15	1.0×0.5mm	0402
18	1.6×0.8mm	0603
1M	1.37×1.0mm	0504
21	2.0×1.25mm	0805
22	2.8×2.8mm	1111
31	3.2×1.6mm	1206
32	3.2×2.5mm	1210
42	4.5×2.0mm	1808
43	4.5×3.2mm	1812
52	5.7×2.8mm	2211
55	5.7×5.0mm	2220

④ Dimension (T) (Except GNM)

Code	Dimension (T)
2	0.2mm
3	0.3mm
5	0.5mm
6	0.6mm
7	0.7mm
8	0.8mm
9	0.85mm
A	1.0mm
B	1.25mm
C	1.6mm
D	2.0mm
E	2.5mm
F	3.2mm
M	1.15mm
N	1.35mm
Q	1.5mm
R	1.8mm
S	2.8mm
X	Depends on individual standards.

④ Elements (GNM Only)

Code	Elements
2	2-elements
4	4-elements

Continued on the following page.

Please check the MURATA home page (<http://www.murata.com/>) if you cannot find the part number in the catalog.

Continued from the preceding page.

⑤ Temperature Characteristics

Temperature Characteristic Codes			Temperature Characteristics			Operating Temperature Range
Code	Public STD Code		Reference Temperature	Temperature Range	Capacitance Change or Temperature Coefficient	
1X	SL *1	JIS	20°C	20 to 85°C	+350 to -1000ppm/°C	-55 to 125°C
2C	CH *1	JIS	20°C	20 to 125°C	0±60ppm/°C	-55 to 125°C
2P	PH *1	JIS	20°C	20 to 85°C	-150±60ppm/°C	-25 to 85°C
2R	RH *1	JIS	20°C	20 to 85°C	-220±60ppm/°C	-25 to 85°C
2S	SH *1	JIS	20°C	20 to 85°C	-330±60ppm/°C	-25 to 85°C
2T	TH *1	JIS	20°C	20 to 85°C	-470±60ppm/°C	-25 to 85°C
3C	CJ *1	JIS	20°C	20 to 125°C	0±120ppm/°C	-55 to 125°C
3P	PJ *1	JIS	20°C	20 to 85°C	-150±120ppm/°C	-25 to 85°C
3R	RJ *1	JIS	20°C	20 to 85°C	-220±120ppm/°C	-25 to 85°C
3S	SJ *1	JIS	20°C	20 to 85°C	-330±120ppm/°C	-25 to 85°C
3T	TJ *1	JIS	20°C	20 to 85°C	-470±120ppm/°C	-25 to 85°C
3U	UJ *1	JIS	20°C	20 to 85°C	-750±120ppm/°C	-25 to 85°C
4C	CK *1	JIS	20°C	20 to 125°C	0±250ppm/°C	-55 to 125°C
5C	C0G *1	EIA	25°C	25 to 125°C	0±30ppm/°C	-55 to 125°C
5G	X8G *1	EIA	25°C	25 to 150°C	0±30ppm/°C	-55 to 150°C
6C	C0H *1	EIA	25°C	25 to 125°C	0±60ppm/°C	-55 to 125°C
6P	P2H *1	EIA	25°C	25 to 85°C	-150±60ppm/°C	-55 to 125°C
6R	R2H *1	EIA	25°C	25 to 85°C	-220±60ppm/°C	-55 to 125°C
6S	S2H *1	EIA	25°C	25 to 85°C	-330±60ppm/°C	-55 to 125°C
6T	T2H *1	EIA	25°C	25 to 85°C	-470±60ppm/°C	-55 to 125°C
7U	U2J *1	EIA	25°C	25 to 125°C *6	-750±120ppm/°C	-55 to 125°C
B1	B *2	JIS	20°C	-25 to 85°C	±10%	-25 to 85°C
B3	B	JIS	20°C	-25 to 85°C	±10%	-25 to 85°C
C7	X7S	EIA	25°C	-55 to 125°C	±22%	-55 to 125°C
C8	X6S	EIA	25°C	-55 to 105°C	±22%	-55 to 105°C
D7	X7T	EIA	25°C	-55 to 125°C	+22, -33%	-55 to 125°C
D8	X6T	EIA	25°C	-55 to 105°C	+22, -33%	-55 to 105°C
E7	X7U	EIA	25°C	-55 to 125°C	+22, -56%	-55 to 125°C
F1	F *2	JIS	20°C	-25 to 85°C	+30, -80%	-25 to 85°C
F5	Y5V	EIA	25°C	-30 to 85°C	+22, -82%	-30 to 85°C
L8	X8L	*3	25°C	-55 to 150°C	+15, -40%	-55 to 150°C
R1	R *2	JIS	20°C	-55 to 125°C	±15%	-55 to 125°C
R3	R	JIS	20°C	-55 to 125°C	±15%	-55 to 125°C
R6	X5R	EIA	25°C	-55 to 85°C	±15%	-55 to 85°C
R7	X7R	EIA	25°C	-55 to 125°C	±15%	-55 to 125°C
R9	X8R	EIA	25°C	-55 to 150°C	±15%	-55 to 150°C
W0	-	-	25°C	-55 to 125°C	±10% *4	-55 to 125°C
					+22, -33% *5	

*1 Please refer to table for Capacitance Change under reference temperature.

*2 Capacitance change is specified with 50% rated voltage applied.

*3 Murata Temperature Characteristic Code.

*4 Apply DC350V bias.

*5 No DC bias.

*6 Rated Voltage 100Vdc max : 25 to 85°C

Continued on the following page. 

Continued from the preceding page.

●Capacitance Change from each temperature

JIS Code

Murata Code	Capacitance Change from 20°C (%)					
	-55°C		-25°C		-10°C	
	Max.	Min.	Max.	Min.	Max.	Min.
1X	-	-	-	-	-	-
2C	0.82	-0.45	0.49	-0.27	0.33	-0.18
2P	-	-	1.32	0.41	0.88	0.27
2R	-	-	1.70	0.72	1.13	0.48
2S	-	-	2.30	1.22	1.54	0.81
2T	-	-	3.07	1.85	2.05	1.23
3C	1.37	-0.90	0.82	-0.54	0.55	-0.36
3P	-	-	1.65	0.14	1.10	0.09
3R	-	-	2.03	0.45	1.35	0.30
3S	-	-	2.63	0.95	1.76	0.63
3T	-	-	3.40	1.58	2.27	1.05
3U	-	-	4.94	2.84	3.29	1.89
4C	2.56	-1.88	1.54	-1.13	1.02	-0.75

EIA Code

Murata Code	Capacitance Change from 25°C (%)					
	-55°C		-30°C		-10°C	
	Max.	Min.	Max.	Min.	Max.	Min.
5C/5G	0.58	-0.24	0.40	-0.17	0.25	-0.11
6C	0.87	-0.48	0.59	-0.33	0.38	-0.21
6P	2.33	0.72	1.61	0.50	1.02	0.32
6R	3.02	1.28	2.08	0.88	1.32	0.56
6S	4.09	2.16	2.81	1.49	1.79	0.95
6T	5.46	3.28	3.75	2.26	2.39	1.44
7U	8.78	5.04	6.04	3.47	3.84	2.21

⑥Rated Voltage

Code	Rated Voltage
0E	DC2.5V
0G	DC4V
0J	DC6.3V
1A	DC10V
1C	DC16V
1E	DC25V
YA	DC35V
1H	DC50V
2A	DC100V
2D	DC200V
2E	DC250V
YD	DC300V
2H	DC500V
2J	DC630V
3A	DC1kV
3D	DC2kV
3F	DC3.15kV
BB	DC350V (for Camera Flash Circuit)
E2	AC250V
GC	X1/Y2; AC250V (Safety Standard Certified Type GC)
GF	Y2, X1/Y2; AC250V (Safety Standard Certified Type GF)
GD	Y3; AC250V (Safety Standard Certified Type GD)
GB	X2; AC250V (Safety Standard Certified Type GB)

⑦Capacitance

Expressed by three-digit alphanumerics. The unit is picofarad (pF). The first and second figures are significant digits, and the third figure expresses the number of zeros which follow the two numbers. If there is a decimal point, it is expressed by the capital letter "R." In this case, all figures are significant digits.

Ex.)

Code	Capacitance
R50	0.5pF
1R0	1.0pF
100	10pF
103	10000pF

Continued on the following page. 

Please check the MURATA home page (<http://www.murata.com/>) if you cannot find the part number in the catalog.

Continued from the preceding page.

⑧ Capacitance Tolerance

Code	Capacitance Tolerance	TC	Series	Capacitance Step	
W	±0.05pF	CΔ	GRM/GJM	≤9.9pF	0.1pF
B	±0.1pF	CΔ	GRM/GJM	≤9.9pF	0.1pF
			GQM	≤1pF	0.1pF
C	±0.25pF	CΔ	GRM/GJM	≤9.9pF	1pF Step and E24 Series
		except CΔ	GRM	≤5pF	* 1pF
		CΔ	GQM	≤1pF	0.1pF
D	±0.5pF	CΔ	GRM/GJM	1.1 to 9.9pF	1pF Step and E24 Series
		except CΔ	GRM	5.1 to 9.9pF	0.1pF
		CΔ	GQM	5.1 to 9.9pF	* 1pF
G	±2%	CΔ	GJM	≥10pF	E12 Series
		CΔ	GQM	≥10pF	E24 Series
J	±5%	CΔ, SL, U2J	GRM/GA3	≥10pF	E12 Series
		CΔ	GQM/GJM	≥10pF	E24 Series
K	±10%	B, R, X7R, X5R, ZLM	GRJ/GRM/GR7/GA3	E6 Series	
		C0G	GNM	E6 Series	
		B, R, X7R, X5R, ZLM	GR4, GMD	E12 Series	
M	±20%	B, R, X7R, X7S	GRM/GMA	E6 Series	
		X5R, X7R, X7S	GNM	E3 Series	
		X7R	GA2	E3 Series	
		X5R, X7R, X7S, X6S	LLL/LLR/LLA/LLM	E3 Series	
Z	+80%, -20%	F, Y5V	GRM	E3 Series	
R	Depends on individual standards.				

* E24 series is also available.

⑨ Individual Specification Code (Except LLR)

Expressed by three figures.

⑨ ESR (LLR Only)

Code	ESR
E01	100mΩ
E03	220mΩ
E05	470mΩ
E07	1000mΩ

⑩ Packaging

Code	Packaging
L	ø180mm Embossed Taping
D	ø180mm Paper Taping
E	ø180mm Paper Taping (LLL15)
K	ø330mm Embossed Taping
J	ø330mm Paper Taping
F	ø330mm Paper Taping (LLL15)
B	Bulk
C	Bulk Case
T	Bulk Tray

Please check the MURATA home page (<http://www.murata.com/>) if you cannot find the part number in the catalog.

Chip Monolithic Ceramic Capacitors



AC250V Type (Which Meet Japanese Law) GA2 Series

■ Features

1. Chip monolithic ceramic capacitor for AC lines.
2. A new monolithic structure for small, high capacitance capable of operating at high voltage levels.
3. Sn-plated external electrodes realize good solderability.
4. Only for reflow soldering
5. Capacitance 0.01 to 0.1uF for connecting lines and 470 to 4700pF for connecting lines to earth.

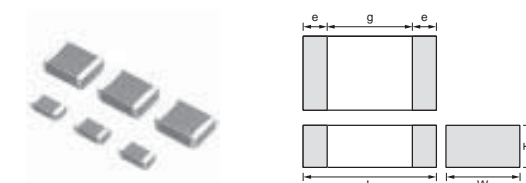

Part Number	Dimensions (mm)				
	L	W	T	e min.	g min.
GA242Q	4.5 ±0.3	2.0 ±0.2	1.5 +0, -0.3	0.3	2.5
GA243D	4.5 ±0.4	3.2 ±0.3	2.0 +0, -0.3		
GA243Q			1.5 +0, -0.3		
GA255D	5.7 ±0.4	5.0 ±0.4	2.0 +0, -0.3		3.2

■ Applications

Noise suppression filters for switching power supplies, telephones, facsimiles, modems.

Do not use these products in any Automotive Power train or Safety equipment including Battery chargers for Electric Vehicles and Plug-in Hybrids. Only Murata products clearly stipulated as "for Automotive use" can be used for automobile applications such as Power train and Safety equipment.

■ Reference Standard

GA2 series obtains no safety approval. This series is based on the standards of the electrical appliance and material safety law of Japan (separated table 4).

Part Number	Rated Voltage (V)	TC Code (Standard)	Capacitance	Length L (mm)	Width W (mm)	Thickness T (mm)	Electrode g min. (mm)	Electrode e (mm)
GA242QR7E2471MW01L	AC250 (r.m.s.)	X7R (EIA)	470pF ±20%	4.5	2.0	1.5	2.5	0.3 min.
GA242QR7E2102MW01L	AC250 (r.m.s.)	X7R (EIA)	1000pF ±20%	4.5	2.0	1.5	2.5	0.3 min.
GA243QR7E2222MW01L	AC250 (r.m.s.)	X7R (EIA)	2200pF ±20%	4.5	3.2	1.5	2.5	0.3 min.
GA243QR7E2332MW01L	AC250 (r.m.s.)	X7R (EIA)	3300pF ±20%	4.5	3.2	1.5	2.5	0.3 min.
GA243DR7E2472MW01L	AC250 (r.m.s.)	X7R (EIA)	4700pF ±20%	4.5	3.2	2.0	2.5	0.3 min.
GA243QR7E2103MW01L	AC250 (r.m.s.)	X7R (EIA)	10000pF ±20%	4.5	3.2	1.5	2.5	0.3 min.
GA243QR7E2223MW01L	AC250 (r.m.s.)	X7R (EIA)	22000pF ±20%	4.5	3.2	1.5	2.5	0.3 min.
GA243DR7E2473MW01L	AC250 (r.m.s.)	X7R (EIA)	47000pF ±20%	4.5	3.2	2.0	2.5	0.3 min.
GA255DR7E2104MW01L	AC250 (r.m.s.)	X7R (EIA)	0.10μF ±20%	5.7	5.0	2.0	3.2	0.3 min.

For General Purpose GRM/GRJ Series

Only for Applications

AC250V Type GA2 Series

Safety Standard Certified GA3 Series

Product Information

GA2 Series Specifications and Test Methods

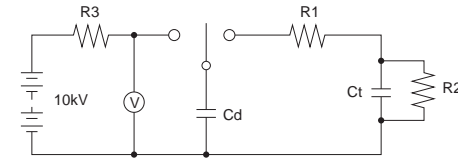
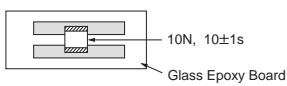
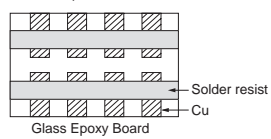
No.	Item	Specifications	Test Method												
1	Operating Temperature Range	-55 to +125°C	—												
2	Appearance	No defects or abnormalities	Visual inspection												
3	Dimensions	Within the specified dimensions	Using calipers and micrometers												
4	Dielectric Strength	No defects or abnormalities	No failure should be observed when voltage in the table is applied between the terminations for 60±1 sec., provided the charge/discharge current is less than 50mA. <table border="1"> <thead> <tr> <th>Nominal Capacitance</th> <th>Test Voltage</th> </tr> </thead> <tbody> <tr> <td>C ≥ 10,000pF</td> <td>AC575V (r.m.s.)</td> </tr> <tr> <td>C < 10,000pF</td> <td>AC1500V (r.m.s.)</td> </tr> </tbody> </table>	Nominal Capacitance	Test Voltage	C ≥ 10,000pF	AC575V (r.m.s.)	C < 10,000pF	AC1500V (r.m.s.)						
Nominal Capacitance	Test Voltage														
C ≥ 10,000pF	AC575V (r.m.s.)														
C < 10,000pF	AC1500V (r.m.s.)														
5	Insulation Resistance (I.R.)	More than 2,000MΩ	The insulation resistance should be measured with DC500±50V and within 60±5 sec. of charging.												
6	Capacitance	Within the specified tolerance	The capacitance/D.F. should be measured at a frequency of 1±0.2kHz and a voltage of AC1±0.2V (r.m.s.)												
7	Dissipation Factor (D.F.)	0.025 max.													
8	Capacitance Temperature Characteristics	Cap. Change Within ±15% (Temp. Range: -55 to +125°C)	The capacitance measurement should be made at each step specified in the Table. <table border="1"> <thead> <tr> <th>Step</th> <th>Temperature (°C)</th> </tr> </thead> <tbody> <tr> <td>1</td> <td>25±2</td> </tr> <tr> <td>2</td> <td>Min. Operating Temp.±3</td> </tr> <tr> <td>3</td> <td>25±2</td> </tr> <tr> <td>4</td> <td>Max. Operating Temp.±2</td> </tr> <tr> <td>5</td> <td>25±2</td> </tr> </tbody> </table> <p>•Pretreatment Perform a heat treatment at 150±,8°C for 60±5 min. and then let sit for 24±2 hrs. at room condition.*</p>	Step	Temperature (°C)	1	25±2	2	Min. Operating Temp.±3	3	25±2	4	Max. Operating Temp.±2	5	25±2
Step	Temperature (°C)														
1	25±2														
2	Min. Operating Temp.±3														
3	25±2														
4	Max. Operating Temp.±2														
5	25±2														
9	Discharge Test (Application: Nominal Capacitance C < 10,000pF)	Appearance	No defects or abnormalities <p>As in Fig., discharge is made 50 times at 5 sec. intervals from the capacitor (Cd) charged at DC voltage of specified.</p>  <p>Ct: Capacitor under test Cd: 0.001μF R1: 1,000Ω R2: 100MΩ R3: Surge resistance</p>												
10	Adhesive Strength of Termination	No removal of the terminations or other defects should occur.	Solder the capacitor to the testing jig (glass epoxy board) shown in Fig. 1. Then apply 10N force in the direction of the arrow. The soldering should be done using the reflow method and should be conducted with care so that the soldering is uniform and free of defects such as heat shock.  <p>Fig. 1</p>												
11	Vibration Resistance	Appearance	No defects or abnormalities												
		Capacitance	Within the specified tolerance												
	D.F.	0.025 max.	The capacitor should be subjected to a simple harmonic motion having a total amplitude of 1.5mm, the frequency being varied uniformly between the approximate limits of 10 and 55Hz. The frequency range, from 10 to 55Hz and return to 10Hz, should be traversed in approximately 1 min. This motion should be applied for a period of 2 hrs. in each of 3 mutually perpendicular directions (total of 6 hrs.). 												

* "Room condition" Temperature: 15 to 35°C, Relative humidity: 45 to 75%, Atmospheric pressure: 86 to 106kPa

Continued on the following page. 

GA2 Series Specifications and Test Methods

Continued from the preceding page.

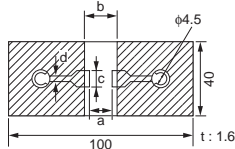
No.	Item	Specifications	Test Method																			
12	Deflection	No marking defects	Solder the capacitor to the testing jig (glass epoxy board) shown in Fig. 2. Then apply a force in the direction shown in Fig. 3. The soldering should be done using the reflow method and should be conducted with care so that the soldering is uniform and free of defects such as heat shock.																			
		<div style="text-align: center;">  <p>Fig. 2</p> <table border="1" style="margin-left: auto; margin-right: auto;"> <thead> <tr> <th rowspan="2">L×W (mm)</th> <th colspan="4">Dimension (mm)</th> </tr> <tr> <th>a</th> <th>b</th> <th>c</th> <th>d</th> </tr> </thead> <tbody> <tr> <td>4.5×2.0</td> <td>3.5</td> <td>7.0</td> <td>2.4</td> <td rowspan="3" style="text-align: center;">1.0</td> </tr> <tr> <td>4.5×3.2</td> <td>3.5</td> <td>7.0</td> <td>3.7</td> </tr> <tr> <td>5.7×5.0</td> <td>4.5</td> <td>8.0</td> <td>5.6</td> </tr> </tbody> </table> </div>		L×W (mm)	Dimension (mm)				a	b	c	d	4.5×2.0	3.5	7.0	2.4	1.0	4.5×3.2	3.5	7.0	3.7	5.7×5.0
L×W (mm)	Dimension (mm)																					
	a	b	c	d																		
4.5×2.0	3.5	7.0	2.4	1.0																		
4.5×3.2	3.5	7.0	3.7																			
5.7×5.0	4.5	8.0	5.6																			
13	Solderability of Termination	75% of the terminations are to be soldered evenly and continuously.	Immerse the capacitor in a solution of ethanol (JIS-K-8101) and rosin (JIS-K-5902) (25% rosin in weight proportion). Immerse in solder solution for 2±0.5 sec. Immersing speed: 25±2.5mm/s Temp. of solder: 245±5°C Lead Free Solder (Sn-3.0Ag-0.5Cu) 235±5°C H60A or H63A Eutectic Solder																			
14	Humidity Insulation	Appearance	The capacitor should be subjected to 40±2°C, relative humidity of 90 to 98% for 8 hrs., and then removed in room condition* for 16 hrs. until 5 cycles.																			
		Capacitance Change																				
		D.F.																				
		I.R.																				
		Dielectric Strength																				
15	Resistance to Soldering Heat	Appearance	Preheat the capacitor as in table. Immerse the capacitor in solder solution at 260±5°C for 10±1 sec. Let sit at room condition* for 24±2 hrs., then measure. •Immersing speed: 25±2.5mm/s •Pretreatment Perform a heat treatment at 150±1.0°C for 60±5 min. and then let sit for 24±2 hrs. at room condition.* *Preheating <table border="1" style="margin-left: auto; margin-right: auto; width: 100%;"> <thead> <tr> <th>Step</th> <th>Temperature</th> <th>Time</th> </tr> </thead> <tbody> <tr> <td>1</td> <td>100 to 120°C</td> <td>1 min.</td> </tr> <tr> <td>2</td> <td>170 to 200°C</td> <td>1 min.</td> </tr> </tbody> </table>	Step	Temperature	Time	1	100 to 120°C	1 min.	2	170 to 200°C	1 min.										
		Step		Temperature	Time																	
		1		100 to 120°C	1 min.																	
		2		170 to 200°C	1 min.																	
		Capacitance Change																				
D.F.																						
I.R.																						
16	Temperature Cycle	Appearance	Fix the capacitor to the supporting jig (glass epoxy board) shown in Fig. 4. Perform the 5 cycles according to the 4 heat treatments listed in the following table. Let sit for 24±2 hrs. at room condition,* then measure. <table border="1" style="margin-left: auto; margin-right: auto; width: 100%;"> <thead> <tr> <th>Step</th> <th>Temperature (°C)</th> <th>Time (min.)</th> </tr> </thead> <tbody> <tr> <td>1</td> <td>Min. Operating Temp.±3</td> <td>30±3</td> </tr> <tr> <td>2</td> <td>Room Temp.</td> <td>2 to 3</td> </tr> <tr> <td>3</td> <td>Max. Operating Temp.±2</td> <td>30±3</td> </tr> <tr> <td>4</td> <td>Room Temp.</td> <td>2 to 3</td> </tr> </tbody> </table>	Step	Temperature (°C)	Time (min.)	1	Min. Operating Temp.±3	30±3	2	Room Temp.	2 to 3	3	Max. Operating Temp.±2	30±3	4	Room Temp.	2 to 3				
		Step		Temperature (°C)	Time (min.)																	
		1		Min. Operating Temp.±3	30±3																	
		2		Room Temp.	2 to 3																	
		3		Max. Operating Temp.±2	30±3																	
4	Room Temp.	2 to 3																				
Capacitance Change																						
D.F.																						
I.R.																						
Dielectric Strength																						

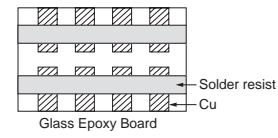
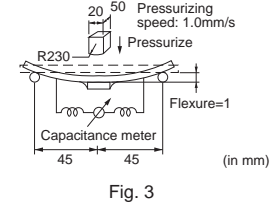

* "Room condition" Temperature: 15 to 35°C, Relative humidity: 45 to 75%, Atmospheric pressure: 86 to 106kPa

Continued on the following page.

For General Purpose GRM/GRJ Series
 Only for Applications
 AC250V Type GA2 Series
 Safety Standard Certified GA3 Series
 Product Information

GA2 Series Specifications and Test Methods

Continued from the preceding page.

No.	Item	Specifications	Test Method									
17	Humidity (Steady State)	Appearance	No marking defects									
		Capacitance Change	Within $\pm 15\%$									
		D.F.	0.05 max.									
		I.R.	More than 1,000M Ω									
		Dielectric Strength	In accordance with item No.4									
			Let the capacitor sit at 40 $\pm 2^{\circ}\text{C}$ and relative humidity of 90 to 95% for 500 $\pm 2^{\circ}$ hrs. Remove and let sit for 24 ± 2 hrs. at room condition,* then measure. •Pretreatment Perform a heat treatment at 150 $\pm 1^{\circ}\text{C}$ for 60 ± 5 min. and then let sit for 24 ± 2 hrs. at room condition.*									
18	Life	Appearance	No marking defects									
		Capacitance Change	Within $\pm 20\%$									
		D.F.	0.05 max.									
		I.R.	More than 1,000M Ω									
		Dielectric Strength	In accordance with item No.4									
			Apply voltage and time as in Table at maximum operating temperature $\pm 3^{\circ}\text{C}$. Remove and let sit for 24 ± 2 hrs. at room condition,* then measure. The charge / discharge current is less than 50mA. <table border="1" style="margin-left: auto; margin-right: auto;"> <thead> <tr> <th>Nominal Capacitance</th> <th>Test Time</th> <th>Test Voltage</th> </tr> </thead> <tbody> <tr> <td>$C \geq 10,000\text{pF}$</td> <td>1,000$\pm 4^{\circ}$ hrs.</td> <td>AC300V (r.m.s.)</td> </tr> <tr> <td>$C < 10,000\text{pF}$</td> <td>1,500$\pm 4^{\circ}$ hrs.</td> <td>AC500V (r.m.s.)*</td> </tr> </tbody> </table> * Except that once each hour the voltage is increased to AC1,000V (r.m.s.) for 0.1 sec. •Pretreatment Apply test voltage for 60 ± 5 min. at test temperature. Remove and let sit for 24 ± 2 hrs. at room condition.*	Nominal Capacitance	Test Time	Test Voltage	$C \geq 10,000\text{pF}$	1,000 $\pm 4^{\circ}$ hrs.	AC300V (r.m.s.)	$C < 10,000\text{pF}$	1,500 $\pm 4^{\circ}$ hrs.	AC500V (r.m.s.)*
Nominal Capacitance	Test Time	Test Voltage										
$C \geq 10,000\text{pF}$	1,000 $\pm 4^{\circ}$ hrs.	AC300V (r.m.s.)										
$C < 10,000\text{pF}$	1,500 $\pm 4^{\circ}$ hrs.	AC500V (r.m.s.)*										
19	Humidity Loading	Appearance	No marking defects									
		Capacitance Change	Within $\pm 15\%$									
		D.F.	0.05 max.									
		I.R.	More than 1,000M Ω									
		Dielectric Strength	In accordance with item No.4									
			Apply the rated voltage at 40 $\pm 2^{\circ}\text{C}$ and relative humidity of 90 to 95% for 500 $\pm 2^{\circ}$ hrs. Remove and let sit for 24 ± 2 hrs. at room condition,* then measure. •Pretreatment Apply test voltage for 60 ± 5 min. at test temperature. Remove and let sit for 24 ± 2 hrs. at room condition.*									

* "Room condition" Temperature: 15 to 35 $^{\circ}\text{C}$, Relative humidity: 45 to 75%, Atmospheric pressure: 86 to 106kPa

For General Purpose GRM/GRJ Series

Only for Applications

AC250V Type GA2 Series

Safety Standard Certified GA3 Series

Product Information

Chip Monolithic Ceramic Capacitors



Safety Standard Certified GA3 Series UL, IEC60384-14 Class X1/Y2 Type GC

■ Features

1. Chip monolithic ceramic capacitor (certified as conforming to safety standards) for AC lines.
2. A new monolithic structure for small, high capacitance capable of operating at high voltage levels.
3. Compared to lead type capacitors, this new capacitor is greatly downsized and low-profiled to 1/10 or less in volume, and 1/4 or less in height.
4. Type GC can be used as an X1-class and Y2-class capacitor, line-by-pass capacitor of UL1414.
5. +125 degree C guaranteed
6. Only for reflow soldering

■ Applications

1. Ideal for use as Y capacitor or X capacitor for various switching power supplies
2. Ideal for modem applications

Do not use these products in any Automotive Power train or Safety equipment including Battery chargers for Electric Vehicles and Plug-in Hybrids. Only Murata products clearly stipulated as "for Automotive use" can be used for automobile applications such as Power train and Safety equipment.

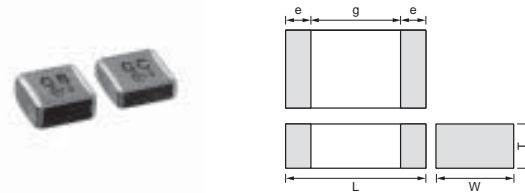

Part Number	Dimensions (mm)				
	L	W	T	e min.	g min.
GA355D	5.7 ±0.4	5.0 ±0.4	2.0 ±0.3	0.3	4.0

■ Standard Certification

	Standard No.	Class	Rated Voltage
UL	UL1414	Line By-pass	AC250V (r.m.s.)
VDE	IEC 60384-14 EN 60384-14	X1, Y2	
BSI	EN 60065 (14.2) IEC 60384-14 EN 60384-14		
SEMKO	IEC 60384-14 EN 60384-14		
ESTI	EN 60065 IEC 60384-14		

Part Number	Rated Voltage (V)	TC Code (Standard)	Capacitance (pF)	Length L (mm)	Width W (mm)	Thickness T (mm)	Electrode g min. (mm)	Electrode e (mm)
GA355DR7GC101KY02L	AC250 (r.m.s.)	X7R (EIA)	100 ±10%	5.7	5.0	2.0	4.0	0.3 min.
GA355DR7GC151KY02L	AC250 (r.m.s.)	X7R (EIA)	150 ±10%	5.7	5.0	2.0	4.0	0.3 min.
GA355DR7GC221KY02L	AC250 (r.m.s.)	X7R (EIA)	220 ±10%	5.7	5.0	2.0	4.0	0.3 min.
GA355DR7GC331KY02L	AC250 (r.m.s.)	X7R (EIA)	330 ±10%	5.7	5.0	2.0	4.0	0.3 min.

For General Purpose GRM/GRJ Series

Only for Applications

AC250V Type GA2 Series

Safety Standard Certified GA3 Series

Product Information

Chip Monolithic Ceramic Capacitors



Safety Standard Certified GA3 Series IEC60384-14 Class Y2, X1/Y2 Type GF

■ Features

1. Available for equipment based on IEC/EN60950 and UL1950. Besides, the GA352/355 types are available for equipment based on IEC/EN60065, UL1492, and UL6500.
2. Type GF can be used as a Y2-class capacitor.
3. A new monolithic structure for small, high capacitance capable of operating at high voltage levels.
4. +125 degree C guaranteed
5. Only for reflow soldering

■ Applications

1. Ideal for use on line filters and couplings for DAA modems without transformers
2. Ideal for use on line filters for information equipment
3. Ideal for use as Y capacitor or X capacitor for various switching power supplies (GA352/355 types only)

Do not use these products in any Automotive Power train or Safety equipment including Battery chargers for Electric Vehicles and Plug-in Hybrids. Only Murata products clearly stipulated as "for Automotive use" can be used for automobile applications such as Power train and Safety equipment.

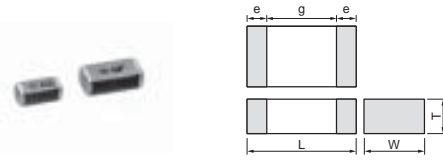

Part Number	Dimensions (mm)				
	L	W	T	e min.	g min.
GA342A	4.5 ±0.3	2.0 ±0.2	1.0 +0, -0.3	0.3	2.5
GA342D			2.0 ±0.2		
GA342Q			1.5 +0, -0.3		
GA352Q	5.7 ±0.4	2.8 ±0.3	1.5 +0, -0.3		4.0
GA355D			2.0 +0, -0.3		
GA355Q			1.5 +0, -0.3		

■ Standard Certification

	Standard No.	Class	Status of Certification		Rated Voltage
			Size : 4.5x2.0mm	Size : 5.7x2.8mm and over	
UL	UL1414	X1, Y2	—	⊙	AC250V (r.m.s.)
	UL 60950-1	—	⊙	—	
VDE	IEC 60384-14	X1, Y2	—	⊙	(r.m.s.)
SEMKO	EN 60384-14	Y2	⊙	⊙	

Applications

Size	Switching power supplies	Communication network devices such as a modem
4.5x2.0mm	—	⊙
5.7x2.8mm and over	⊙	⊙

Part Number	Rated Voltage (V)	TC Code (Standard)	Capacitance (pF)	Length L (mm)	Width W (mm)	Thickness T (mm)	Electrode g min. (mm)	Electrode e (mm)
GA342D1XGF100JY02L	AC250 (r.m.s.)	SL (JIS)	10 ±5%	4.5	2.0	2.0	2.5	0.3 min.
GA342D1XGF120JY02L	AC250 (r.m.s.)	SL (JIS)	12 ±5%	4.5	2.0	2.0	2.5	0.3 min.
GA342D1XGF150JY02L	AC250 (r.m.s.)	SL (JIS)	15 ±5%	4.5	2.0	2.0	2.5	0.3 min.
GA342D1XGF180JY02L	AC250 (r.m.s.)	SL (JIS)	18 ±5%	4.5	2.0	2.0	2.5	0.3 min.
GA342D1XGF220JY02L	AC250 (r.m.s.)	SL (JIS)	22 ±5%	4.5	2.0	2.0	2.5	0.3 min.
GA342A1XGF270JW31L	AC250 (r.m.s.)	SL (JIS)	27 ±5%	4.5	2.0	1.0	2.5	0.3 min.
GA342A1XGF330JW31L	AC250 (r.m.s.)	SL (JIS)	33 ±5%	4.5	2.0	1.0	2.5	0.3 min.
GA342A1XGF390JW31L	AC250 (r.m.s.)	SL (JIS)	39 ±5%	4.5	2.0	1.0	2.5	0.3 min.
GA342A1XGF470JW31L	AC250 (r.m.s.)	SL (JIS)	47 ±5%	4.5	2.0	1.0	2.5	0.3 min.
GA342A1XGF560JW31L	AC250 (r.m.s.)	SL (JIS)	56 ±5%	4.5	2.0	1.0	2.5	0.3 min.
GA342A1XGF680JW31L	AC250 (r.m.s.)	SL (JIS)	68 ±5%	4.5	2.0	1.0	2.5	0.3 min.
GA342A1XGF820JW31L	AC250 (r.m.s.)	SL (JIS)	82 ±5%	4.5	2.0	1.0	2.5	0.3 min.
GA342QR7GF101KW01L	AC250 (r.m.s.)	X7R (EIA)	100 ±10%	4.5	2.0	1.5	2.5	0.3 min.
GA342QR7GF151KW01L	AC250 (r.m.s.)	X7R (EIA)	150 ±10%	4.5	2.0	1.5	2.5	0.3 min.
GA342DR7GF221KW02L	AC250 (r.m.s.)	X7R (EIA)	220 ±10%	4.5	2.0	2.0	2.5	0.3 min.
GA342DR7GF331KW02L	AC250 (r.m.s.)	X7R (EIA)	330 ±10%	4.5	2.0	2.0	2.5	0.3 min.
GA342QR7GF471KW01L	AC250 (r.m.s.)	X7R (EIA)	470 ±10%	4.5	2.0	1.5	2.5	0.3 min.
GA352QR7GF471KW01L	AC250 (r.m.s.)	X7R (EIA)	470 ±10%	5.7	2.8	1.5	4.0	0.3 min.
GA342QR7GF681KW01L	AC250 (r.m.s.)	X7R (EIA)	680 ±10%	4.5	2.0	1.5	2.5	0.3 min.
GA352QR7GF681KW01L	AC250 (r.m.s.)	X7R (EIA)	680 ±10%	5.7	2.8	1.5	4.0	0.3 min.
GA342DR7GF102KW02L	AC250 (r.m.s.)	X7R (EIA)	1000 ±10%	4.5	2.0	2.0	2.5	0.3 min.
GA352QR7GF102KW01L	AC250 (r.m.s.)	X7R (EIA)	1000 ±10%	5.7	2.8	1.5	4.0	0.3 min.

Continued on the following page.

Continued from the preceding page.

Part Number	Rated Voltage (V)	TC Code (Standard)	Capacitance (pF)	Length L (mm)	Width W (mm)	Thickness T (mm)	Electrode g min. (mm)	Electrode e (mm)
GA352QR7GF152KW01L	AC250 (r.m.s.)	X7R (EIA)	1500 ±10%	5.7	2.8	1.5	4.0	0.3 min.
GA355QR7GF182KW01L	AC250 (r.m.s.)	X7R (EIA)	1800 ±10%	5.7	5.0	1.5	4.0	0.3 min.
GA355QR7GF222KW01L	AC250 (r.m.s.)	X7R (EIA)	2200 ±10%	5.7	5.0	1.5	4.0	0.3 min.
GA355QR7GF332KW01L	AC250 (r.m.s.)	X7R (EIA)	3300 ±10%	5.7	5.0	1.5	4.0	0.3 min.
GA355DR7GF472KW01L	AC250 (r.m.s.)	X7R (EIA)	4700 ±10%	5.7	5.0	2.0	4.0	0.3 min.

For General Purpose GRM/GRJ Series

Only for Applications

AC250V Type GA2 Series

Safety Standard Certified GA3 Series

Product Information

Chip Monolithic Ceramic Capacitors



Safety Standard Certified GA3 Series IEC60384-14 Class Y3 Type GD

■ Features

1. Available for equipment based on IEC/EN60950 and UL1950.
2. Type GD can be used as a Y3-class capacitor.
3. A new monolithic structure for small, high capacitance capable of operating at high voltage levels.
4. +125 degree C guaranteed
5. Only for reflow soldering

■ Applications

1. Ideal for use on line filters and couplings for DAA modems without transformers
2. Ideal for use on line filters for information equipment

Do not use these products in any Automotive Power train or Safety equipment including Battery chargers for Electric Vehicles and Plug-in Hybrids. Only Murata products clearly stipulated as "for Automotive use" can be used for automobile applications such as Power train and Safety equipment.

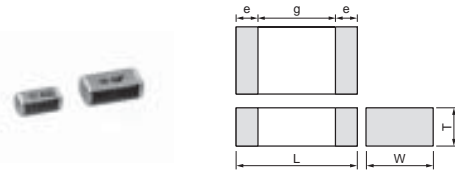

Part Number	Dimensions (mm)				
	L	W	T	e min.	g min.
GA342A	4.5 ±0.3	2.0 ±0.2	1.0 +0, -0.3	0.3	2.5
GA342D			2.0 ±0.2		
GA342Q			1.5 +0, -0.3		
GA343D	4.5 ±0.4	3.2 ±0.3	2.0 +0, -0.3		
GA343Q			1.5 +0, -0.3		

■ Standard Certification

	Standard No.	Class	Rated Voltage
UL	UL 60950-1	Y3	AC250V(r.m.s.)
SEMKO	IEC 60384-14 EN 60384-14		

Applications

Size	Switching power supplies	Communication network devices such as a modem
4.5×3.2mm and under	—	⊙

Part Number	Rated Voltage (V)	TC Code (Standard)	Capacitance (pF)	Length L (mm)	Width W (mm)	Thickness T (mm)	Electrode g min. (mm)	Electrode e (mm)
GA342D1XGD100JY02L	AC250 (r.m.s.)	SL (JIS)	10 ±5%	4.5	2.0	2.0	2.5	0.3 min.
GA342D1XGD120JY02L	AC250 (r.m.s.)	SL (JIS)	12 ±5%	4.5	2.0	2.0	2.5	0.3 min.
GA342D1XGD150JY02L	AC250 (r.m.s.)	SL (JIS)	15 ±5%	4.5	2.0	2.0	2.5	0.3 min.
GA342D1XGD180JY02L	AC250 (r.m.s.)	SL (JIS)	18 ±5%	4.5	2.0	2.0	2.5	0.3 min.
GA342D1XGD220JY02L	AC250 (r.m.s.)	SL (JIS)	22 ±5%	4.5	2.0	2.0	2.5	0.3 min.
GA342A1XGD270JW31L	AC250 (r.m.s.)	SL (JIS)	27 ±5%	4.5	2.0	1.0	2.5	0.3 min.
GA342A1XGD330JW31L	AC250 (r.m.s.)	SL (JIS)	33 ±5%	4.5	2.0	1.0	2.5	0.3 min.
GA342A1XGD390JW31L	AC250 (r.m.s.)	SL (JIS)	39 ±5%	4.5	2.0	1.0	2.5	0.3 min.
GA342A1XGD470JW31L	AC250 (r.m.s.)	SL (JIS)	47 ±5%	4.5	2.0	1.0	2.5	0.3 min.
GA342A1XGD560JW31L	AC250 (r.m.s.)	SL (JIS)	56 ±5%	4.5	2.0	1.0	2.5	0.3 min.
GA342A1XGD680JW31L	AC250 (r.m.s.)	SL (JIS)	68 ±5%	4.5	2.0	1.0	2.5	0.3 min.
GA342A1XGD820JW31L	AC250 (r.m.s.)	SL (JIS)	82 ±5%	4.5	2.0	1.0	2.5	0.3 min.
GA342QR7GD101KW01L	AC250 (r.m.s.)	X7R (EIA)	100 ±10%	4.5	2.0	1.5	2.5	0.3 min.
GA342QR7GD151KW01L	AC250 (r.m.s.)	X7R (EIA)	150 ±10%	4.5	2.0	1.5	2.5	0.3 min.
GA342QR7GD221KW01L	AC250 (r.m.s.)	X7R (EIA)	220 ±10%	4.5	2.0	1.5	2.5	0.3 min.
GA342QR7GD331KW01L	AC250 (r.m.s.)	X7R (EIA)	330 ±10%	4.5	2.0	1.5	2.5	0.3 min.
GA342QR7GD471KW01L	AC250 (r.m.s.)	X7R (EIA)	470 ±10%	4.5	2.0	1.5	2.5	0.3 min.
GA342QR7GD681KW01L	AC250 (r.m.s.)	X7R (EIA)	680 ±10%	4.5	2.0	1.5	2.5	0.3 min.
GA342QR7GD102KW01L	AC250 (r.m.s.)	X7R (EIA)	1000 ±10%	4.5	2.0	1.5	2.5	0.3 min.
GA342QR7GD152KW01L	AC250 (r.m.s.)	X7R (EIA)	1500 ±10%	4.5	2.0	1.5	2.5	0.3 min.
GA343QR7GD182KW01L	AC250 (r.m.s.)	X7R (EIA)	1800 ±10%	4.5	3.2	1.5	2.5	0.3 min.
GA343QR7GD222KW01L	AC250 (r.m.s.)	X7R (EIA)	2200 ±10%	4.5	3.2	1.5	2.5	0.3 min.
GA343DR7GD472KW01L	AC250 (r.m.s.)	X7R (EIA)	4700 ±10%	4.5	3.2	2.0	2.5	0.3 min.

Chip Monolithic Ceramic Capacitors



Safety Standard Certified GA3 Series IEC60384-14 Class X2 Type GB

■ Features

1. Type GB can be used as an X2-class capacitor.
2. Chip monolithic ceramic capacitor (certified as conforming to safety standards) for AC lines.
3. A new monolithic structure for small, high capacitance capable of operating at high voltage levels.
4. Compared to lead type capacitors, this new capacitor is greatly downsized and low-profiled to 1/10 or less in volume, and 1/4 or less in height.
5. +125 degree C guaranteed
6. Only for reflow soldering

■ Applications

Ideal for use as X capacitor for various switching power supplies

Do not use these products in any Automotive Power train or Safety equipment including Battery chargers for Electric Vehicles and Plug-in Hybrids. Only Murata products clearly stipulated as "for Automotive use" can be used for automobile applications such as Power train and Safety equipment.

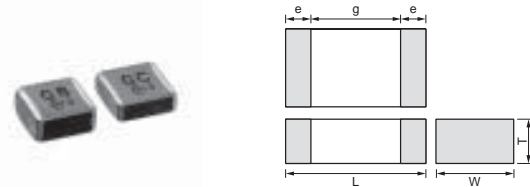

Part Number	Dimensions (mm)				
	L	W	T	e min.	g min.
GA355Q	5.7 ±0.4	5.0 ±0.4	1.5 +0,-0.3	0.3	3.0
GA355D			2.0 +0,-0.3		
GA355E			2.5 +0,-0.3		
GA355X			2.9 +0,-0.4		

■ Standard Certification

	Standard No.	Class	Rated Voltage
VDE	IEC 60384-14 EN 60384-14	X2	AC250V (r.m.s.)
SEMKO			
ESTI			

Part Number	Rated Voltage (V)	TC Code (Standard)	Capacitance (pF)	Length L (mm)	Width W (mm)	Thickness T (mm)	Electrode g min. (mm)	Electrode e (mm)
GA355QR7GB103KW01L	AC250 (r.m.s.)	X7R (EIA)	10000 ±10%	5.7	5.0	1.5	3.0	0.3 min.
GA355QR7GB153KW01L	AC250 (r.m.s.)	X7R (EIA)	15000 ±10%	5.7	5.0	1.5	3.0	0.3 min.
GA355DR7GB223KW01L	AC250 (r.m.s.)	X7R (EIA)	22000 ±10%	5.7	5.0	2.0	3.0	0.3 min.
GA355ER7GB333KW01L	AC250 (r.m.s.)	X7R (EIA)	33000 ±10%	5.7	5.0	2.5	3.0	0.3 min.
GA355ER7GB473KW01L	AC250 (r.m.s.)	X7R (EIA)	47000 ±10%	5.7	5.0	2.5	3.0	0.3 min.
GA355XR7GB563KW06L	AC250 (r.m.s.)	X7R (EIA)	56000 ±10%	5.7	5.0	2.9	3.0	0.3 min.

For General Purpose GRM/GRJ Series

Only for Applications

AC250V Type GA2 Series

Safety Standard Certified GA3 Series

Product Information

GA3 Series Specifications and Test Methods

For General Purpose GRM/GRJ Series

Only for Applications

AC250V Type GA2 Series

Safety Standard Certified GA3 Series

Product Information

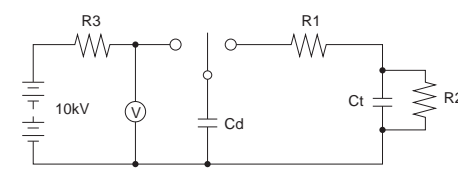
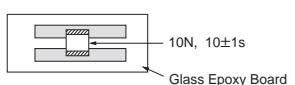
No.	Item	Specifications	Test Method																				
1	Operating Temperature Range	-55 to +125°C	—																				
2	Appearance	No defects or abnormalities	Visual inspection																				
3	Dimensions	Within the specified dimensions	Using calipers and micrometers																				
4	Dielectric Strength	No defects or abnormalities	No failure should be observed when voltage in the table is applied between the terminations for 60±1 sec., provided the charge/discharge current is less than 50mA. <table border="1" style="margin-left: auto; margin-right: auto;"> <thead> <tr> <th colspan="2">Test Voltage</th> </tr> </thead> <tbody> <tr> <td>Type GB</td> <td>DC1075V</td> </tr> <tr> <td>Type GC/GD</td> <td>AC1500V (r.m.s.)</td> </tr> <tr> <td>Type GF</td> <td>AC2000V (r.m.s.)</td> </tr> </tbody> </table>	Test Voltage		Type GB	DC1075V	Type GC/GD	AC1500V (r.m.s.)	Type GF	AC2000V (r.m.s.)												
Test Voltage																							
Type GB	DC1075V																						
Type GC/GD	AC1500V (r.m.s.)																						
Type GF	AC2000V (r.m.s.)																						
5	Pulse Voltage (Application: Type GD/GF)	No self healing breakdowns or flash-overs have taken place in the capacitor.	10 impulses of alternating polarity are subjected. (5 impulses for each polarity) The interval between impulses is 60 sec. Applied Pulse: 1.2/50µs Applied Voltage: 2.5kVo-p																				
6	Insulation Resistance (I.R.)	More than 6,000MΩ	The insulation resistance should be measured with DC500±50V and within 60±5 sec. of charging.																				
7	Capacitance	Within the specified tolerance																					
8	Dissipation Factor (D.F.) Q	<table border="1" style="margin-left: auto; margin-right: auto;"> <thead> <tr> <th>Char.</th> <th>Specification</th> </tr> </thead> <tbody> <tr> <td>X7R</td> <td>D.F. ≤0.025</td> </tr> <tr> <td rowspan="2">SL</td> <td>Q ≥ 400 + 20C*2 (C < 30pF)</td> </tr> <tr> <td>Q ≥ 1000 (C ≥ 30pF)</td> </tr> </tbody> </table>	Char.	Specification	X7R	D.F. ≤0.025	SL	Q ≥ 400 + 20C*2 (C < 30pF)	Q ≥ 1000 (C ≥ 30pF)	The capacitance/Q/D.F. should be measured at a frequency of 1±0.2kHz (SL char.: 1±0.2MHz) and a voltage of AC1±0.2V (r.m.s.)													
Char.	Specification																						
X7R	D.F. ≤0.025																						
SL	Q ≥ 400 + 20C*2 (C < 30pF)																						
	Q ≥ 1000 (C ≥ 30pF)																						
9	Capacitance Temperature Characteristics	<table border="1" style="margin-left: auto; margin-right: auto;"> <thead> <tr> <th>Char.</th> <th>Capacitance Change</th> </tr> </thead> <tbody> <tr> <td>X7R</td> <td>Within ±15%</td> </tr> </tbody> </table> Temperature characteristic guarantee is -55 to +125°C <table border="1" style="margin-left: auto; margin-right: auto;"> <thead> <tr> <th>Char.</th> <th>Temperature Coefficient</th> </tr> </thead> <tbody> <tr> <td>SL</td> <td>+350 to -1000ppm/°C</td> </tr> </tbody> </table> Temperature characteristic guarantee is +20 to +85°C	Char.	Capacitance Change	X7R	Within ±15%	Char.	Temperature Coefficient	SL	+350 to -1000ppm/°C	The capacitance measurement should be made at each step specified in the Table. <table border="1" style="margin-left: auto; margin-right: auto;"> <thead> <tr> <th>Step</th> <th>Temperature (°C)</th> </tr> </thead> <tbody> <tr> <td>1</td> <td>25±2 (20±2 for SL char.)</td> </tr> <tr> <td>2</td> <td>Min. Operating Temp.±3</td> </tr> <tr> <td>3</td> <td>25±2 (20±2 for SL char.)</td> </tr> <tr> <td>4</td> <td>Max. Operating Temp.±2</td> </tr> <tr> <td>5</td> <td>25±2 (20±2 for SL char.)</td> </tr> </tbody> </table> SL char. : The capacitance should be measured at even 85°C between step 3 and step 4. •Pretreatment for X7R char. Perform a heat treatment at 150±10°C for 60±5 min. and then let sit for 24±2 hrs. at room condition.*1	Step	Temperature (°C)	1	25±2 (20±2 for SL char.)	2	Min. Operating Temp.±3	3	25±2 (20±2 for SL char.)	4	Max. Operating Temp.±2	5	25±2 (20±2 for SL char.)
Char.	Capacitance Change																						
X7R	Within ±15%																						
Char.	Temperature Coefficient																						
SL	+350 to -1000ppm/°C																						
Step	Temperature (°C)																						
1	25±2 (20±2 for SL char.)																						
2	Min. Operating Temp.±3																						
3	25±2 (20±2 for SL char.)																						
4	Max. Operating Temp.±2																						
5	25±2 (20±2 for SL char.)																						
10	Appearance	No defects or abnormalities	As in Fig., discharge is made 50 times at 5 sec. intervals from the capacitor (Cd) charged at DC voltage of specified.  Ct: Capacitor under test Cd: 0.001µF R1: 1,000Ω R2: 100MΩ R3: Surge resistance																				
	I.R.	More than 1,000MΩ																					
	Dielectric Strength	In accordance with item No.4																					
11	Adhesive Strength of Termination	No removal of the terminations or other defect should occur.	Solder the capacitor to the testing jig (glass epoxy board) shown in Fig. 1. Then apply 10N force in the direction of the arrow. The soldering should be done using the reflow method and should be conducted with care so that the soldering is uniform and free of defects such as heat shock.  Fig. 1																				

*1 "Room condition" Temperature: 15 to 35°C, Relative humidity: 45 to 75%, Atmospheric pressure: 86 to 106kPa
 *2 "C" expresses nominal capacitance value (pF).

Continued on the following page.

GA3 Series Specifications and Test Methods

Continued from the preceding page.

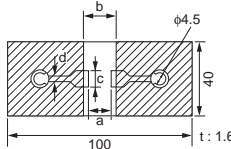
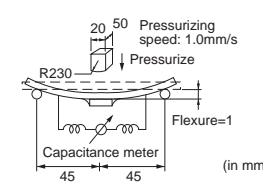
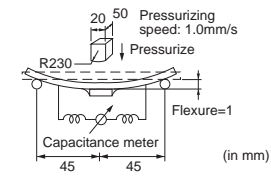
No.	Item	Specifications	Test Method																										
12	Appearance	No defects or abnormalities	Solder the capacitor to the test jig (glass epoxy board). The capacitor should be subjected to a simple harmonic motion having a total amplitude of 1.5mm, the frequency being varied uniformly between the approximate limits of 10 and 55Hz. The frequency range, from 10 to 55Hz and return to 10Hz, should be traversed in approximately 1 min. This motion should be applied for a period of 2 hrs. in each of 3 mutually perpendicular directions (total of 6 hrs.).																										
	Capacitance	Within the specified tolerance																											
12	D.F. Q	<table border="1" style="width: 100%; border-collapse: collapse;"> <thead> <tr> <th style="width: 15%;">Char.</th> <th style="width: 85%;">Specification</th> </tr> </thead> <tbody> <tr> <td>X7R</td> <td>D.F. ≤ 0.025</td> </tr> <tr> <td>SL</td> <td>Q ≥ 400 + 20C*2 (C < 30pF) Q ≥ 1000 (C ≥ 30pF)</td> </tr> </tbody> </table>	Char.	Specification	X7R	D.F. ≤ 0.025	SL	Q ≥ 400 + 20C*2 (C < 30pF) Q ≥ 1000 (C ≥ 30pF)	 <p style="text-align: center;">Glass Epoxy Board</p>																				
		Char.	Specification																										
X7R	D.F. ≤ 0.025																												
SL	Q ≥ 400 + 20C*2 (C < 30pF) Q ≥ 1000 (C ≥ 30pF)																												
13	Deflection	<p>No marking defects</p>  <p style="text-align: center;">Fig. 2</p> <table border="1" style="width: 100%; border-collapse: collapse;"> <thead> <tr> <th rowspan="2">L×W (mm)</th> <th colspan="4">Dimension (mm)</th> </tr> <tr> <th>a</th> <th>b</th> <th>c</th> <th>d</th> </tr> </thead> <tbody> <tr> <td>4.5×2.0</td> <td>3.5</td> <td>7.0</td> <td>2.4</td> <td rowspan="4" style="text-align: center; vertical-align: middle;">1.0</td> </tr> <tr> <td>4.5×3.2</td> <td>3.5</td> <td>7.0</td> <td>3.7</td> </tr> <tr> <td>5.7×2.8</td> <td>4.5</td> <td>8.0</td> <td>3.2</td> </tr> <tr> <td>5.7×5.0</td> <td>4.5</td> <td>8.0</td> <td>5.6</td> </tr> </tbody> </table>	L×W (mm)	Dimension (mm)				a	b	c	d	4.5×2.0	3.5	7.0	2.4	1.0	4.5×3.2	3.5	7.0	3.7	5.7×2.8	4.5	8.0	3.2	5.7×5.0	4.5	8.0	5.6	<p>Solder the capacitor to the testing jig (glass epoxy board) shown in Fig. 2.</p> <p>Then apply a force in the direction shown in Fig. 3. The soldering should be done using the reflow method and should be conducted with care so that the soldering is uniform and free of defects such as heat shock.</p>  <p style="text-align: center;">Fig. 3</p>
L×W (mm)	Dimension (mm)																												
	a	b	c	d																									
4.5×2.0	3.5	7.0	2.4	1.0																									
4.5×3.2	3.5	7.0	3.7																										
5.7×2.8	4.5	8.0	3.2																										
5.7×5.0	4.5	8.0	5.6																										
14	Solderability of Termination	75% of the terminations are to be soldered evenly and continuously.	<p>Immerse the capacitor in a solution of ethanol (JIS-K-8101) and rosin (JIS-K-5902) (25% rosin in weight proportion). Immerse in solder solution for 2±0.5 sec.</p> <p>Immersing speed: 25±2.5mm/s</p> <p>Temp. of solder: 245±5°C Lead Free Solder (Sn-3.0Ag-0.5Cu) 235±5°C H60A or H63A Eutectic Solder</p>																										
15	Appearance	No marking defects	<p>Preheat the capacitor as in table. Immerse the capacitor in solder solution at 260±5°C for 10±1 sec. Let sit at room condition*1 for 24±2 hrs., then measure.</p> <ul style="list-style-type: none"> Immersing speed: 25±2.5mm/s Pretreatment for X7R char. Perform a heat treatment at 150±18°C for 60±5 min. and then let sit for 24±2 hrs. at room condition.*1 <p>*Preheating</p> <table border="1" style="width: 100%; border-collapse: collapse;"> <thead> <tr> <th>Step</th> <th>Temperature</th> <th>Time</th> </tr> </thead> <tbody> <tr> <td>1</td> <td>100 to 120°C</td> <td>1 min.</td> </tr> <tr> <td>2</td> <td>170 to 200°C</td> <td>1 min.</td> </tr> </tbody> </table>	Step	Temperature	Time	1	100 to 120°C	1 min.	2	170 to 200°C	1 min.																	
	Step	Temperature		Time																									
	1	100 to 120°C		1 min.																									
	2	170 to 200°C		1 min.																									
Resistance to Soldering Heat	Capacitance Change	<table border="1" style="width: 100%; border-collapse: collapse;"> <thead> <tr> <th style="width: 15%;">Char.</th> <th style="width: 85%;">Capacitance Change</th> </tr> </thead> <tbody> <tr> <td>X7R</td> <td>Within ±10%</td> </tr> <tr> <td>SL</td> <td>Within ±2.5% or ±0.25pF (Whichever is larger)</td> </tr> </tbody> </table>	Char.	Capacitance Change	X7R	Within ±10%	SL	Within ±2.5% or ±0.25pF (Whichever is larger)																					
Char.	Capacitance Change																												
X7R	Within ±10%																												
SL	Within ±2.5% or ±0.25pF (Whichever is larger)																												
	I.R.	More than 1,000MΩ																											
	Dielectric Strength	In accordance with item No.4																											

*1 "Room condition" Temperature: 15 to 35°C, Relative humidity: 45 to 75%, Atmospheric pressure: 86 to 106kPa
 *2 "C" expresses nominal capacitance value (pF).

Continued on the following page. ↗

For General Purpose GRM/GRJ Series

Only for Applications

AC250V Type GA2 Series

Safety Standard Certified GA3 Series

Product Information

GA3 Series Specifications and Test Methods

Continued from the preceding page.

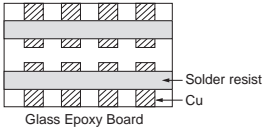
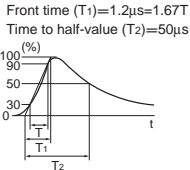
No.	Item	Specifications	Test Method															
16	Appearance	No marking defects	Fix the capacitor to the supporting jig (glass epoxy board) shown in Fig. 4. Perform the 5 cycles according to the 4 heat treatments listed in the following table. Let sit for 24±2 hrs. at room condition,*1 then measure. <table border="1" style="margin: 10px auto;"> <thead> <tr> <th>Step</th> <th>Temperature (°C)</th> <th>Time (min.)</th> </tr> </thead> <tbody> <tr> <td>1</td> <td>Min. Operating Temp.±3</td> <td>30±3</td> </tr> <tr> <td>2</td> <td>Room Temp.</td> <td>2 to 3</td> </tr> <tr> <td>3</td> <td>Max. Operating Temp.±2</td> <td>30±3</td> </tr> <tr> <td>4</td> <td>Room Temp.</td> <td>2 to 3</td> </tr> </tbody> </table> <p>•Pretreatment for X7R char. Perform a heat treatment at 150±18°C for 60±5 min. and then let sit for 24±2 hrs. at room condition.*1</p>  <p style="text-align: center;">Fig. 4</p>	Step	Temperature (°C)	Time (min.)	1	Min. Operating Temp.±3	30±3	2	Room Temp.	2 to 3	3	Max. Operating Temp.±2	30±3	4	Room Temp.	2 to 3
	Step	Temperature (°C)		Time (min.)														
	1	Min. Operating Temp.±3		30±3														
	2	Room Temp.		2 to 3														
	3	Max. Operating Temp.±2		30±3														
4	Room Temp.	2 to 3																
Capacitance Change	Char.	Capacitance Change																
	X7R	Within ±15%																
SL	Within ±2.5% or ±0.25pF (Whichever is larger)																	
D.F. Q	Char.	Specification																
	X7R	D.F. ≤0.05																
SL	Q≥400+20C*2 (C<30pF) Q≥1000 (C≥30pF)																	
I.R.	More than 3,000MΩ																	
Dielectric Strength	In accordance with item No.4																	
17	Appearance	No marking defects	Before this test, the test shown in the following is performed. -Item 11 Adhesive Strength of Termination (applied force is 5N) -Item 13 Deflection Let the capacitor sit at 40±2°C and relative humidity of 90 to 95% for 500±24 hrs. Remove and let sit for 24±2 hrs. at room condition,*1 then measure. •Pretreatment for X7R char. Perform a heat treatment at 150±18°C for 60±5 min. and then let sit for 24±2 hrs. at room condition.*1															
	Capacitance Change	Char.		Capacitance Change														
		X7R		Within ±15%														
	SL	Within ±5.0% or ±0.5pF (Whichever is larger)																
	D.F. Q	Char.		Specification														
X7R		D.F. ≤0.05																
SL	Q≥275+5/2C*2 (C<30pF) Q≥350 (C≥30pF)																	
I.R.	More than 3,000MΩ																	
Dielectric Strength	In accordance with item No.4																	
18	Appearance	No marking defects	Before this test, the test shown in the following is performed. -Item 11 Adhesive Strength of Termination (apply force is 5N) -Item 13 Deflection Impulse Voltage Each individual capacitor should be subjected to a 2.5kV (Type GC/GF: 5kV) Impulse (the voltage value means zero to peak) for three times. Then the capacitors are applied to life test.  <p style="font-size: small;">Front time (T₁)=1.2μs=1.67T Time to half-value (T₂)=50μs</p>															
	Capacitance Change	Char.		Capacitance Change														
		X7R		Within ±20%														
	SL	Within ±3.0% or ±0.3pF (Whichever is larger)																
	D.F. Q	Char.		Specification														
X7R		D.F. ≤0.05																
SL	Q≥275+5/2C*2 (C<30pF) Q≥350 (C≥30pF)																	
I.R.	More than 3,000MΩ																	
Dielectric Strength	In accordance with item No.4																	
18	Life	More than 3,000MΩ	Apply voltage as in Table for 1,000 hrs. at 125±2°C, relative humidity 50% max. <table border="1" style="margin: 10px auto;"> <thead> <tr> <th>Type</th> <th>Applied Voltage</th> </tr> </thead> <tbody> <tr> <td>GB</td> <td>AC312.5V (r.m.s.), except that once each hour the voltage is increased to AC1,000V (r.m.s.) for 0.1 sec.</td> </tr> <tr> <td>GC</td> <td rowspan="3">AC425V (r.m.s.), except that once each hour the voltage is increased to AC1,000V (r.m.s.) for 0.1 sec.</td> </tr> <tr> <td>GF</td> </tr> <tr> <td>GD</td> </tr> </tbody> </table>	Type	Applied Voltage	GB	AC312.5V (r.m.s.), except that once each hour the voltage is increased to AC1,000V (r.m.s.) for 0.1 sec.	GC	AC425V (r.m.s.), except that once each hour the voltage is increased to AC1,000V (r.m.s.) for 0.1 sec.	GF	GD							
			Type	Applied Voltage														
GB	AC312.5V (r.m.s.), except that once each hour the voltage is increased to AC1,000V (r.m.s.) for 0.1 sec.																	
GC	AC425V (r.m.s.), except that once each hour the voltage is increased to AC1,000V (r.m.s.) for 0.1 sec.																	
GF																		
GD																		
Dielectric Strength	In accordance with item No.4																	

*1 "Room condition" Temperature: 15 to 35°C, Relative humidity: 45 to 75%, Atmospheric pressure: 86 to 106kPa
 *2 "C" expresses nominal capacitance value (pF).

Continued on the following page.

GA3 Series Specifications and Test Methods

Continued from the preceding page.

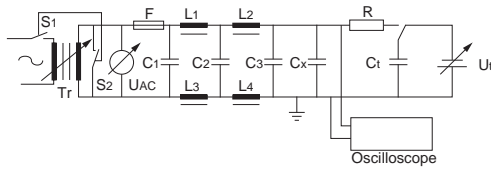
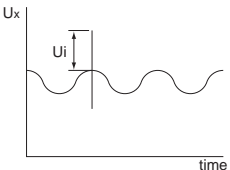
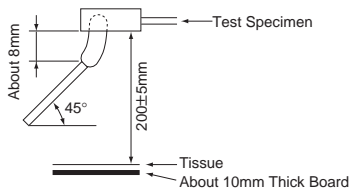
No.	Item	Specifications	Test Method						
19	Appearance	No marking defects	Before this test, the test shown in the following is performed. -Item 11 Adhesive Strength of Termination (apply force is 5N) -Item 13 Deflection Apply the rated voltage at 40±2°C and relative humidity of 90 to 95% for 500±20 hrs. Remove and let sit for 24±2 hrs. at room condition,*1 then measure. •Pretreatment for X7R char. Perform a heat treatment at 150±10 °C for 60±5 min. and then let sit for 24±2 hrs. at room condition.*1						
	Capacitance Change	<table border="1" style="width: 100%; border-collapse: collapse;"> <thead> <tr> <th style="width: 20%;">Char.</th> <th style="width: 80%;">Capacitance Change</th> </tr> </thead> <tbody> <tr> <td style="text-align: center;">X7R</td> <td style="text-align: center;">Within ±15%</td> </tr> <tr> <td style="text-align: center;">SL</td> <td style="text-align: center;">Within ±5.0% or ±0.5pF (Whichever is larger)</td> </tr> </tbody> </table>		Char.	Capacitance Change	X7R	Within ±15%	SL	Within ±5.0% or ±0.5pF (Whichever is larger)
	Char.	Capacitance Change							
	X7R	Within ±15%							
	SL	Within ±5.0% or ±0.5pF (Whichever is larger)							
D.F. Q	<table border="1" style="width: 100%; border-collapse: collapse;"> <thead> <tr> <th style="width: 20%;">Char.</th> <th style="width: 80%;">Specification</th> </tr> </thead> <tbody> <tr> <td style="text-align: center;">X7R</td> <td style="text-align: center;">D.F. ≤0.05</td> </tr> <tr> <td style="text-align: center;">SL</td> <td style="text-align: center;">Q ≥ 275 + 5/2C*2 (C < 30pF) Q ≥ 350 (C ≥ 30pF)</td> </tr> </tbody> </table>	Char.	Specification	X7R	D.F. ≤0.05	SL	Q ≥ 275 + 5/2C*2 (C < 30pF) Q ≥ 350 (C ≥ 30pF)		
Char.	Specification								
X7R	D.F. ≤0.05								
SL	Q ≥ 275 + 5/2C*2 (C < 30pF) Q ≥ 350 (C ≥ 30pF)								
I.R.	More than 3,000MΩ								
Dielectric Strength	In accordance with item No.4								
20	Active Flammability	The cheesecloth should not be on fire.	The capacitor should be individually wrapped in at least one but not more than two complete layers of cheesecloth. The capacitor should be subjected to 20 discharges. The interval between successive discharges should be 5 sec. The UAC should be maintained for 2 min. after the last discharge.						
			 <p style="font-size: small;"> C1,2 : 1μF±10% C3 : 0.033μF±5% 10kV L1 to 4 : 1.5mH±20% 16A Rod core choke Ct : 3μF±5% 10kV R : 100Ω±2% Cx : Capacitor under test UAC : UR±5% F : Fuse, Rated 16A UR : Rated Voltage Ut : Voltage applied to Ct </p>  <table border="1" style="width: 100%; border-collapse: collapse; font-size: x-small;"> <thead> <tr> <th>Type</th> <th>Ui</th> </tr> </thead> <tbody> <tr> <td style="text-align: center;">GD, GB</td> <td style="text-align: center;">2.5kV</td> </tr> <tr> <td style="text-align: center;">GC, GF</td> <td style="text-align: center;">5kV</td> </tr> </tbody> </table>	Type	Ui	GD, GB	2.5kV	GC, GF	5kV
Type	Ui								
GD, GB	2.5kV								
GC, GF	5kV								
21	Passive Flammability	The burning time should not exceed 30 sec. The tissue paper should not ignite.	The capacitor under test should be held in the flame in the position which best promotes burning. Each specimen should be exposed to the flame only once. Time of exposure to flame: 30 sec.						
			<p style="font-size: small;"> Length of flame : 12±1mm Gas burner : Length 35mm min. Inside Dia. 0.5±0.1mm Outside Dia. 0.9mm max. Gas : Butane gas Purity 95% min. </p> 						

*1 "Room condition" Temperature: 15 to 35°C, Relative humidity: 45 to 75%, Atmospheric pressure: 86 to 106kPa
 *2 "C" expresses nominal capacitance value (pF).

For General Purpose GRM/GRJ Series
 Only for Applications
 AC250V Type GA2 Series
 Safety Standard Certified GA3 Series
 Product Information

For General Purpose
GRM/GRJ Series

Only for Applications

AC250V Type
GA2 Series

Safety Standard
Certified GA3 Series

Product Information
Reference Data

GRM/GRJ/GR4/GR7/GA2/GA3 Series Reference Data (Typical Example)

■ Capacitance - Temperature Characteristics

C0G/U2J/SL Characteristics

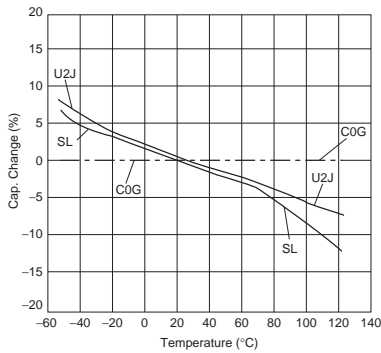

X7R Characteristics

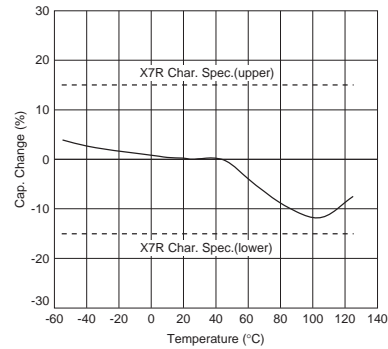

GR4 Series

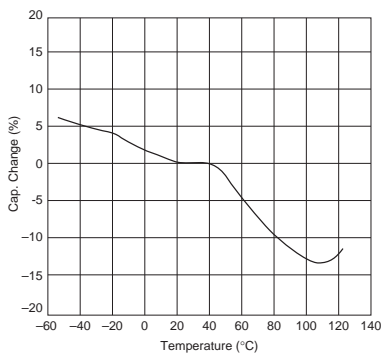

■ Impedance - Frequency Characteristics

GRM Series (C0G Char. 250V)

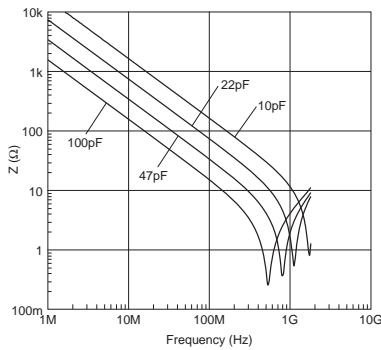

GRM Series (C0G Char. 630V)

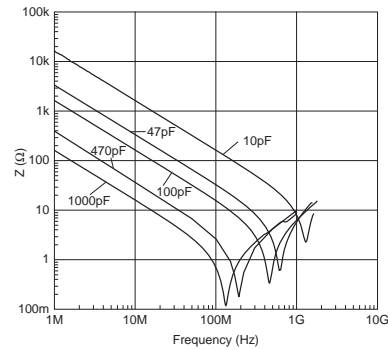

GRM Series (C0G Char. 1kV)

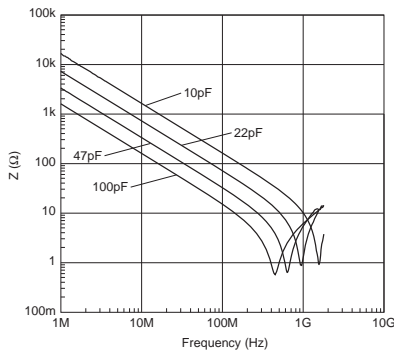

GRM Series (X7R Char. 250V)

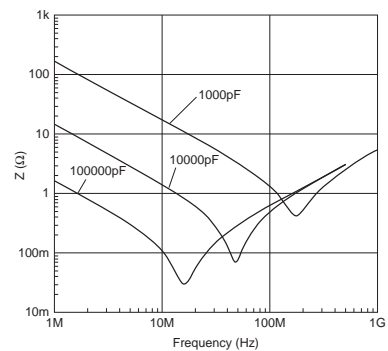

Continued on the following page.

GRM/GRJ/GR4/GR7/GA2/GA3 Series Reference Data (Typical Example)

Continued from the preceding page.

Impedance - Frequency Characteristics

GRM Series (X7R Char. 630V)

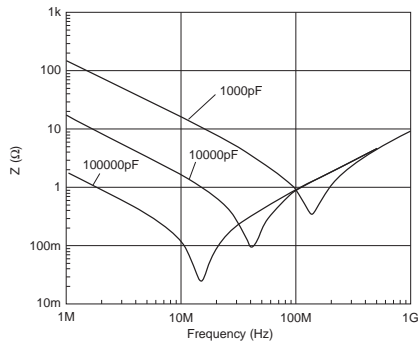

GRJ Series (X7R Char. 250V)

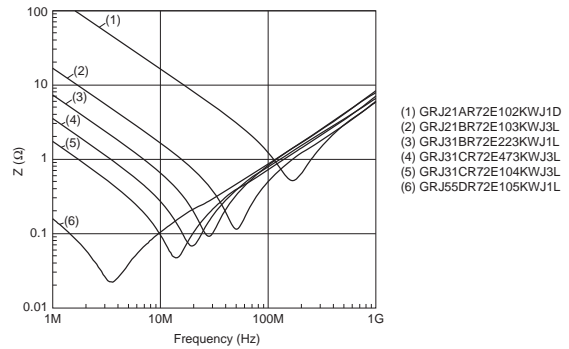

GRJ Series (X7R Char. 630V)

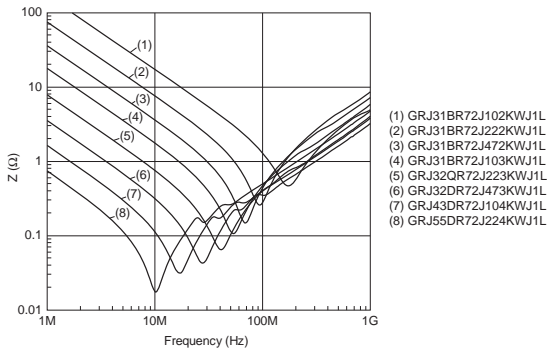

GR4 Series

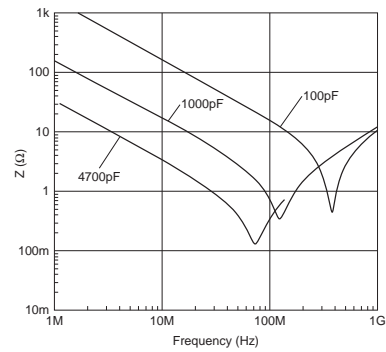

GA2 Series

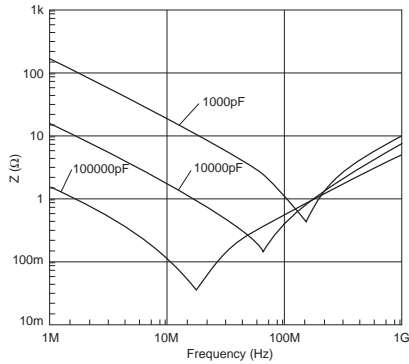

GA3 Series (Type GF)

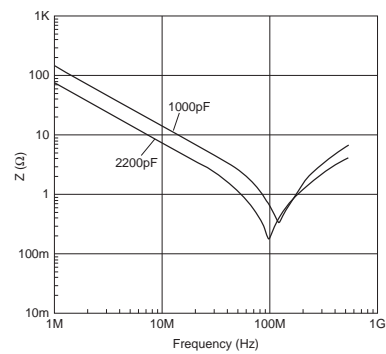

GA3 Series (Type GD)

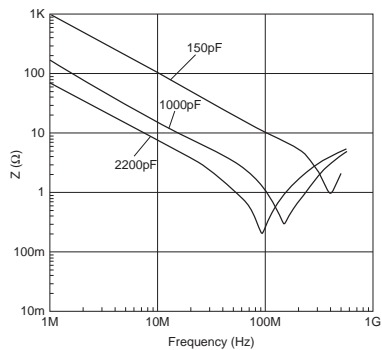

GA3 Series (Type GB)

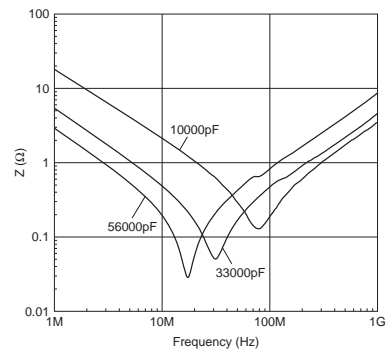

For General Purpose
GRM/GRJ Series

Only for Applications

AC250V Type
GA2 Series

Safety Standard
Certified GA3 Series

Product Information
Reference Data

GRM/GRJ/GR4/GR7/GA2/GA3 Series Reference Data (Typical Example)

For General Purpose
GRM/GRJ Series

Only for Applications

AC250V Type
GA2 Series

Safety Standard
Certified GA3 Series

Product Information
Reference Data

Continued from the preceding page.

Capacitance - AC Voltage Characteristics

GA3 Series (Type GF/GD, X7R Char.)

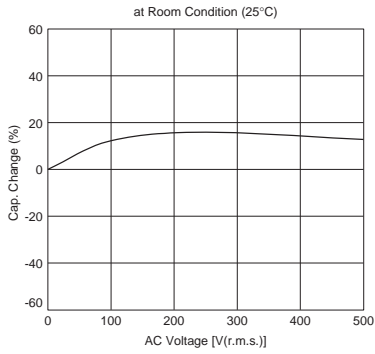

GA3 Series (Type GB)

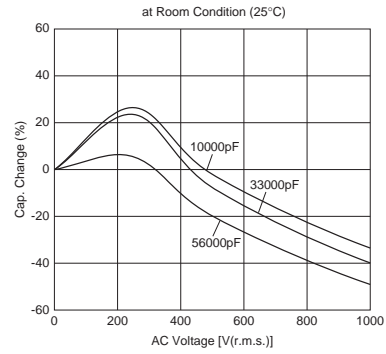

Capacitance - DC Bias Characteristics

GR7 Series

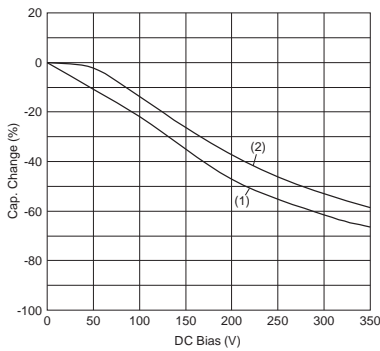

- (1) GR721AW0BB103KW01D
 GR721AW0BB153KW01D
 GR721BW0BB223KW03L
 GR731AW0BB223KW01D
 GR721BW0BB273KW03L
 GR731AW0BB273KW01D
 GR731AW0BB333KW01D
- (2) GR731AW0BB103KW01D
 GR731AW0BB153KW01D
 GR731BW0BB223KW01L
 GR731BW0BB333KW01L
 GR731CW0BB473KW03L

Package

Taping is the standard packaging method.

■ Minimum Quantity Guide

Part Number	Dimensions (mm)			Quantity (pcs.)		
				ø180mm Reel		
	L	W	T	Paper Tape	Embossed Tape	
Medium Voltage	GRM18	1.6	0.8	0.8	4,000	-
	GRJ21/GRM21/GR721	2.0	1.25	1.0	4,000	-
				1.25	-	3,000
	GRJ31/GRM31/GR731	3.2	1.6	1.0	4,000	-
				1.25	-	3,000
				1.6	-	2,000
	GRJ32/GRM32	3.2	2.5	1.0	4,000	-
				1.25	-	3,000
				1.5	-	2,000
				2.0	-	1,000
	GRM42/GR442	4.5	2.0	1.0	-	3,000
				1.5	-	2,000
GRJ43/GRM43/GR443	4.5	3.2	1.5	-	1,000	
			2.0	-	1,000	
			2.5	-	500	
GRJ55/GRM55/GR455	5.7	5.0	2.0	-	1,000	
AC250V	GA242	4.5	2.0	1.5	-	2,000
	GA243	4.5	3.2	1.5	-	1,000
				2.0	-	1,000
GA255	5.7	5.0	2.0	-	1,000	
Safety Std. Certification	GA342	4.5	2.0	1.0	-	3,000
				1.5	-	2,000
				2.0	-	2,000
	GA343	4.5	3.2	1.5	-	1,000
				2.0	-	1,000
	GA352	5.7	2.8	1.5	-	1,000
	GA355	5.7	5.0	1.5	-	1,000
				2.0	-	1,000
				2.5	-	500
2.7				-	500	
2.9	-	500				

For General Purpose
GRM/GRJ Series

Only for Applications

AC250V Type
GA2 Series

Safety Standard
Certified GA3 Series

Product Information
Package

■ Tape Carrier Packaging

(1) Appearance of Taping

① Embossed Tape

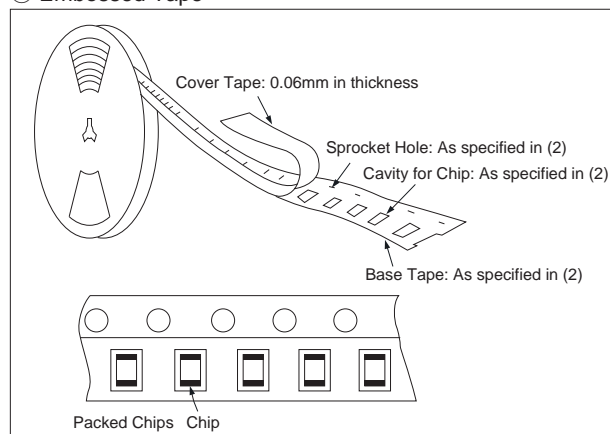

② Paper Tape

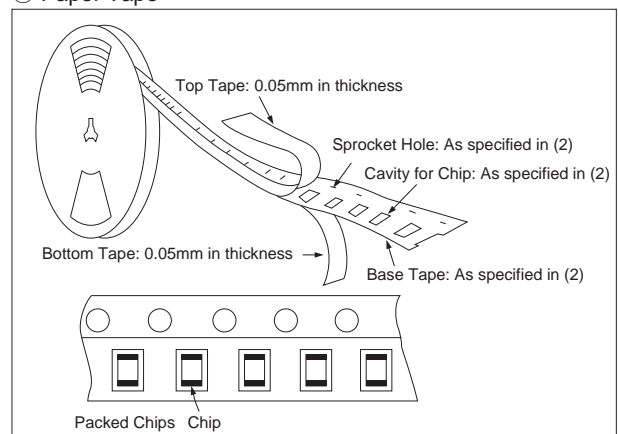

Continued on the following page. ↗

Package

Continued from the preceding page.

(2) Dimensions of Tape

① Embossed Tape

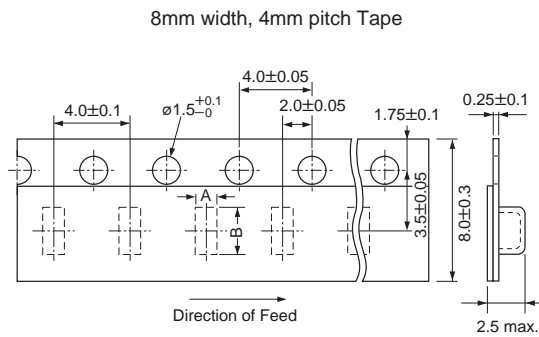

Part Number	A*	B*
GRJ21/GRM21/GR721 (T≥1.25mm)	1.45	2.25
GRJ31/GRM31/GR731 (T≥1.25mm)	2.0	3.6
GRJ32/GRM32 (T≥1.25mm)	2.9	3.6

*Nominal Value

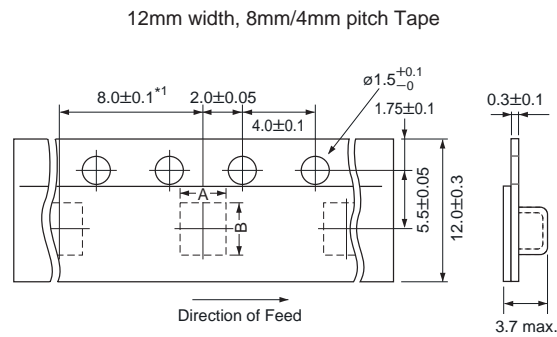

Part Number	A*	B*
GRM42/GR442/GA242/GA342	2.5	5.1
GRJ43/GRM43/GR443/GA243/GA343	3.6	4.9
GA352	3.2	6.1
GRJ55/GRM55/GR455/GA255/GA355	5.4	6.1

*1 4.0±0.1mm in case of GRM42/GR442/GA242/GA342

*Nominal Value

(in mm)

② Paper Tape

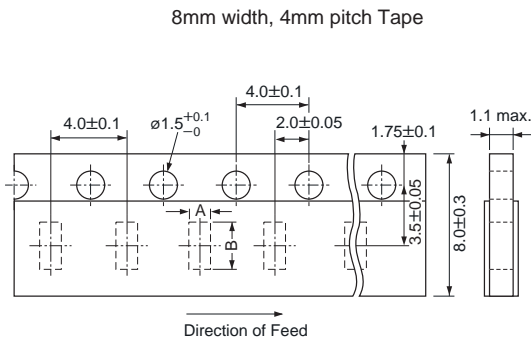

Part Number	A*	B*
GRM18	1.05	1.85
GRJ21/GRM21/GR721 (T=1.0mm)	1.45	2.25
GRM31/GR731 (T=1.0mm)	2.0	3.6
GRM32 (T=1.0mm)	2.9	3.6

*Nominal Value
(in mm)

(3) Dimensions of Reel

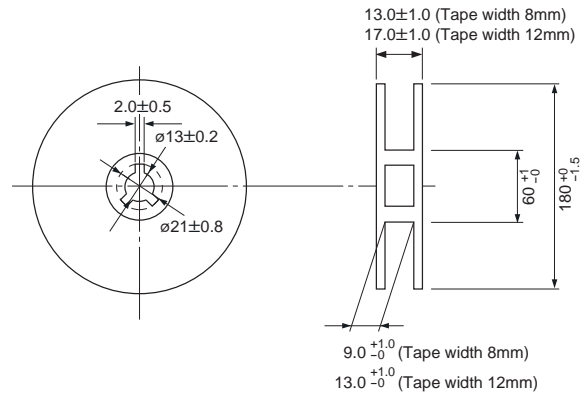

(in mm)

Continued on the following page. ↗

Package

Continued from the preceding page.

(4) Taping Method

- ① Tapes for capacitors are wound clockwise. The sprocket holes are to the right as the tape is pulled toward the user.
- ② Part of the leader and part of the empty tape should be attached to the end of the tape as shown at right.
- ③ The top tape or cover tape and base tape are not attached at the end of the tape for a minimum of 5 pitches.
- ④ Missing capacitors number within 0.1% of the number per reel or 1 pc, whichever is greater, and are not continuous.
- ⑤ The top tape or cover tape and bottom tape should not protrude beyond the edges of the tape and should not cover sprocket holes.
- ⑥ Cumulative tolerance of sprocket holes, 10 pitches: $\pm 0.3\text{mm}$.
- ⑦ Peeling off force: 0.1 to 0.6N in the direction shown at right.

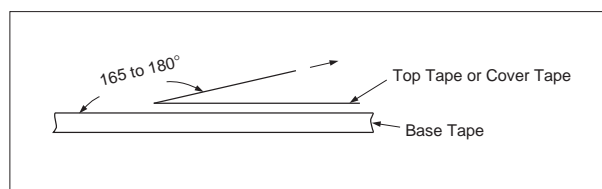
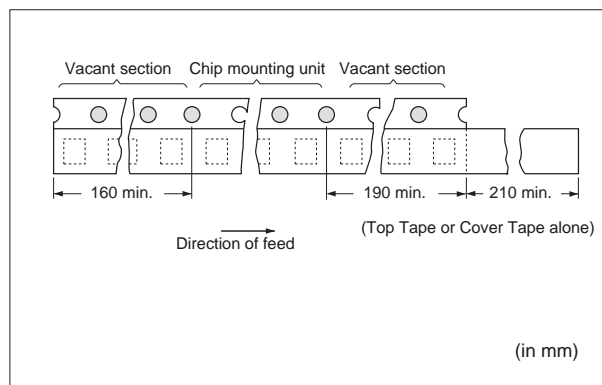

For General Purpose
GRM/GRJ Series

Only for Applications

AC250V Type
GA2 Series

Safety Standard
Certified GA3 Series

Product Information
Package

For General Purpose
GRM/GRJ Series

Only for Applications

AC250V Type
GA2 Series

Safety Standard
Certified GA3 Series

Product Information
△Caution

△Caution

■ Storage and Operating Conditions

Operating and storage environment

Do not use or store capacitors in a corrosive atmosphere, especially where chloride gas, sulfide gas, acid, alkali, salt or the like are present. In addition, avoid exposure to moisture. Before cleaning, bonding or molding this product, verify that these processes do not affect product quality by testing the performance of a cleaned, bonded or molded product in the intended equipment. Store the capacitors where the temperature and relative humidity do not exceed 5 to 40 degrees centigrade and 20 to 70%.

Use capacitors within 6 months of delivery.

Check the solderability after 6 months or more.

FAILURE TO FOLLOW THE ABOVE CAUTIONS MAY RESULT, WORST CASE, IN A SHORT CIRCUIT AND CAUSE FUMING OR PARTIAL DISPERSION WHEN THE PRODUCT IS USED.

■ Handling

1. Vibration and impact

Do not expose a capacitor to excessive shock or vibration during use.

2. Do not directly touch the chip capacitor, especially the ceramic body. Residue from hands/fingers may create a short circuit environment.

FAILURE TO FOLLOW THE ABOVE CAUTIONS MAY RESULT, WORST CASE, IN A SHORT CIRCUIT AND CAUSE FUMING OR PARTIAL DISPERSION WHEN THE PRODUCT IS USED.

Caution

Caution (Rating)

1. Operating Voltage

When DC-rated capacitors are to be used in AC or ripple current circuits, be sure to maintain the V_{p-p} value of the applied voltage or the V_{0-p} which contains DC bias within the rated voltage range.

When the voltage is applied to the circuit, starting or stopping may generate irregular voltage for a transit period because of resonance or switching. Be sure to use a capacitor with a rated voltage range that includes these irregular voltages.

When DC-rated capacitors are to be used in input circuits from a commercial power source (AC filter), be sure to use Safety Certified Capacitors because various regulations for withstanding voltage or impulses, established for all equipment, should be taken into consideration.

Voltage	DC Voltage	DC+AC Voltage	AC Voltage	Pulse Voltage (1)	Pulse Voltage (2)
Positional Measurement					

2. Operating Temperature, Self-generated Heat, and Load Reduction at High-frequency Voltage Condition

Keep the surface temperature of a capacitor below the upper limit of its rated operating temperature range.

Be sure to take into account the heat generated by the capacitor itself. When the capacitor is used in a high-frequency voltage, pulse voltage, it may self-generate heat due to dielectric loss.

(1) In the case of X7R char.

Applied voltage should be the load such as self-generated heat is within 20°C on the condition of atmosphere temperature 25°C. When measuring, use a thermocouple of small thermal capacity -K of $\phi 0.1\text{mm}$ in conditions where the capacitor is not affected by radiant heat from other components or surrounding ambient fluctuations. Excessive heat may lead to deterioration of the capacitor's characteristics and reliability. (Never attempt to perform measurement with the cooling fan running. Otherwise, accurate measurement cannot be ensured.)

Continued on the following page.

For General Purpose
 GRM/GRJ Series

Only for Applications

AC250V Type
 GA2 Series

Safety Standard
 Certified GA3 Series

Product Information
 △Caution

For General Purpose GRM/GRJ Series

Only for Applications

AC250V Type GA2 Series

Safety Standard Certified GA3 Series

Product Information △Caution

Caution

Continued from the preceding page.

(2) In case of C0G, U2J char.

Due to the low self-heating characteristics of low-dissipation capacitors, the allowable electric power of these capacitors is generally much higher than that of X7R characteristic capacitors.

When a high frequency voltage that causes 20°C self-heating to the capacitor is applied, it will exceed the capacitor's allowable electric power.

The frequency of the applied sine wave voltage should be less than 500kHz (less than 100kHz in the case of rated voltage: DC3.15kV). The applied voltage should be less than the value shown in figure below.

In the case of non-sine wave that includes a harmonic frequency, please contact our sales representatives or product engineers. Excessive heat may lead to deterioration of the capacitor's characteristics and reliability. (Never attempt to perform measurement with the cooling fan running. Otherwise, accurate measurement cannot be ensured.)

<C0G char., Rated Voltage: DC3.15kV>

The capacitors less than 22pF can be applied maximum 4.0kV peak to peak at 100kHz or less only for the ballast or the resonance usage in the LCD backlight inverter circuit.

<Capacitor Selection Tool>

We are also offering free software/the capacitor selection tool: "Murata Medium Voltage Capacitors Selection Tool by Voltage Form," which will assist you in selecting a suitable capacitor.

The software can be downloaded from Murata's Website. (<http://www.murata.com/designlib/mmcsv/index.html>).

By inputting capacitance values and the applied voltage waveform of the specific capacitor series, this software will calculate the capacitor's power consumption and list suitable capacitors (non-sine wave is also available).

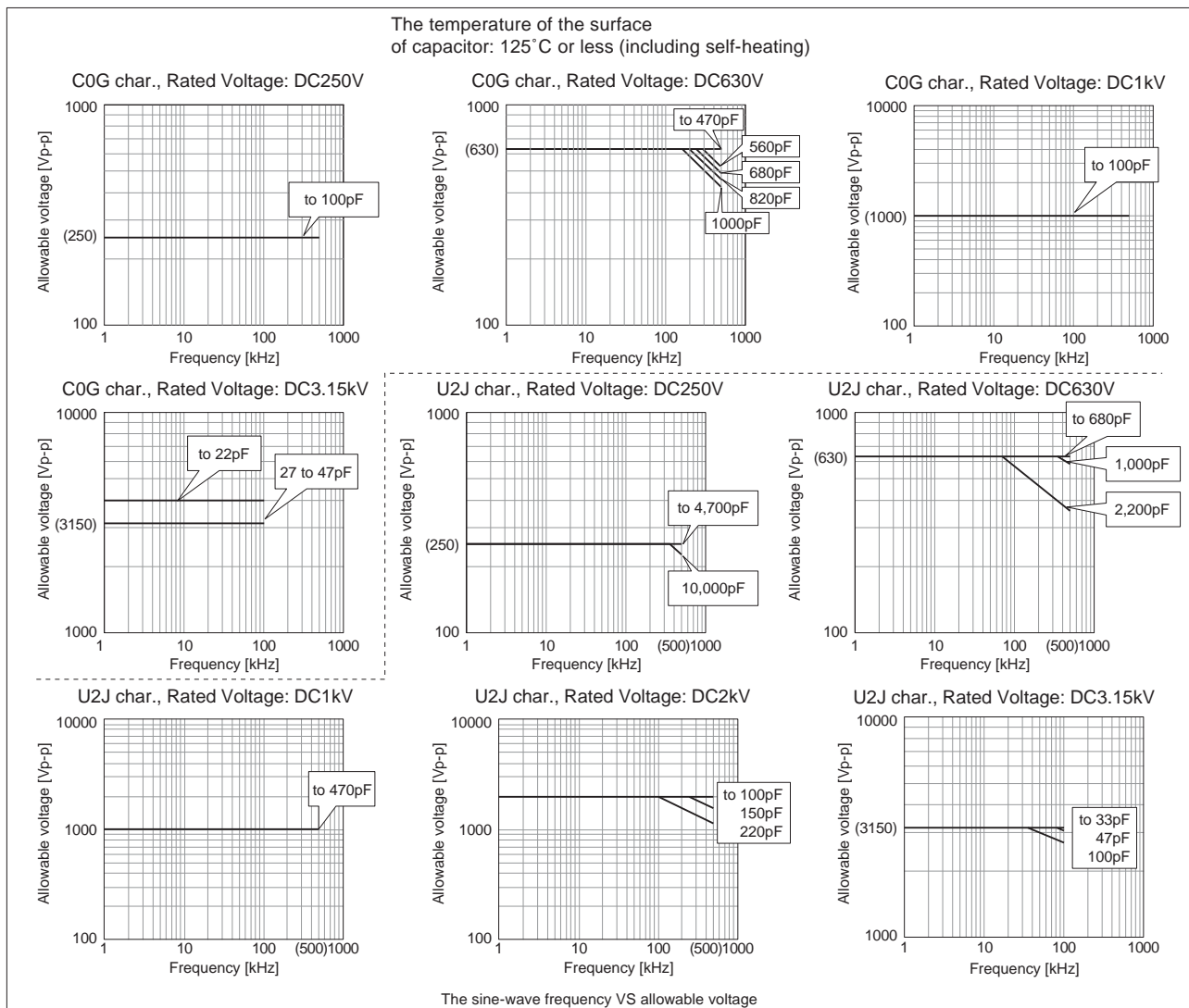

Continued on the following page.

Caution

Continued from the preceding page.

3. Fail-safe

Failure of a capacitor may result in a short circuit. Be sure to provide an appropriate fail-safe function such as a fuse on your product to help eliminate possible electric shock, fire, or fumes.

Please consider using fuses on each AC line if the capacitors are used between the AC input lines and earth (line bypass capacitors), to prepare for the worst case, such as a short circuit.

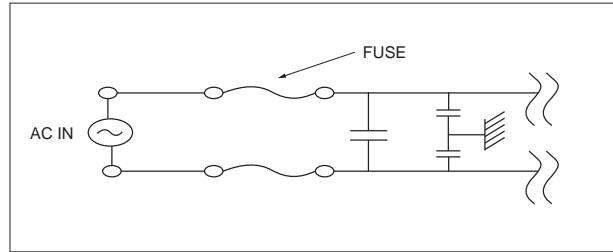

4. Test Condition for AC Withstanding Voltage

(1) Test Equipment

Tests for AC withstanding voltage should be made with equipment capable of creating a wave similar to a 50/60 Hz sine wave.

If the distorted sine wave or overload exceeding the specified voltage value is applied, a defect may be caused.

(2) Voltage Applied Method

The capacitor's leads or terminals should be firmly connected to the output of the withstanding voltage test equipment, and then the voltage should be raised from near zero to the test voltage. If the test voltage is applied directly to the capacitor without raising it from near zero, it should be applied with the zero cross.* At the end of the test time, the test voltage should be reduced to near zero, and then the capacitor's leads or terminals should be taken off the output of the withstanding voltage test equipment. If the test voltage is applied directly to the capacitor without raising it from near zero, surge voltage may occur and cause a defect.

*ZERO CROSS is the point where voltage sine wave passes 0V.

- See the figure at right -

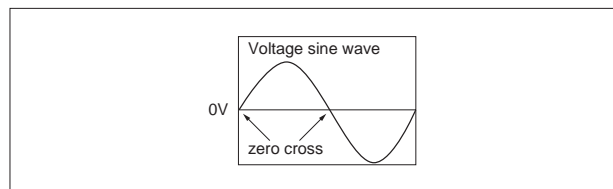

FAILURE TO FOLLOW THE ABOVE CAUTIONS MAY RESULT, WORST CASE, IN A SHORT CIRCUIT AND CAUSE FUMING OR PARTIAL DISPERSION WHEN THE PRODUCT IS USED.

For General Purpose GRM/GRJ Series

Only for Applications

AC250V Type GA2 Series

Safety Standard Certified GA3 Series

Product Information △Caution

Caution

■ Caution (Soldering and Mounting)

1. Vibration and Impact

Do not expose a capacitor to excessive shock or vibration during use.

2. Circuit Board Material

It is possible for the chip to crack by the expansion and shrinkage of a metal board.

Please contact us if you want to use our ceramic capacitors on a metal board such as Aluminum.

3. Land Layout for Cropping PC Board

Choose a mounting position that minimizes the stress imposed on the chip during flexing or bending of the board.

[Component Direction]

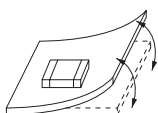

<Example to be avoided>

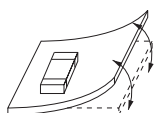

<Example of improvement>

Locate chip horizontal to the direction in which stress acts.

[Chip Mounting Close to Board Separation Point]

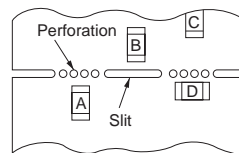

Chip arrangement
Worst A>C>B~D Best

Continued on the following page.



Continued from the preceding page.

4. Reflow Soldering

- When components are exposed to sudden heat, their mechanical strength can be decreased due to the extreme temperature changes which can cause flexing and result in internal mechanical damage, which will cause the parts to fail. In order to prevent mechanical damage, preheating is required for both the components and the PCB board. Preheating conditions are shown in Table 1. It is required to keep the temperature differential between the soldering and the components surface (ΔT) as small as possible.
- Solderability of Tin plating termination chips might be deteriorated when low temperature soldering profile where peak solder temperature is below the Tin melting point is used. Please confirm the solderability of Tin plating termination chips before use.
- When components are immersed in solvent after mounting, be sure to maintain the temperature difference (ΔT) between the component and solvent within the range shown in the Table 1.

Table 1

Part Number	Temperature Differential
G□□18/21/31	$\Delta T \leq 190^\circ\text{C}$
G□□32/42/43/52/55	$\Delta T \leq 130^\circ\text{C}$

Recommended Conditions

	Pb-Sn Solder		Lead Free Solder
	Infrared Reflow	Vapor Reflow	
Peak Temperature	230-250°C	230-240°C	240-260°C
Atmosphere	Air	Air	Air or N ₂

Pb-Sn Solder: Sn-37Pb
 Lead Free Solder: Sn-3.0Ag-0.5Cu

Optimum Solder Amount for Reflow Soldering

- Overly thick application of solder paste results in excessive solder fillet height. This makes the chip more susceptible to mechanical and thermal stress on the board and may cause cracked chips.
- Too little solder paste results in a lack of adhesive strength on the outer electrode, which may result in chips breaking loose from the PCB.
- Make sure the solder has been applied smoothly to the end surface to a height of 0.2mm min.

Inverting the PCB

Make sure not to impose an abnormal mechanical shock on the PCB.

[Standard Conditions for Reflow Soldering]

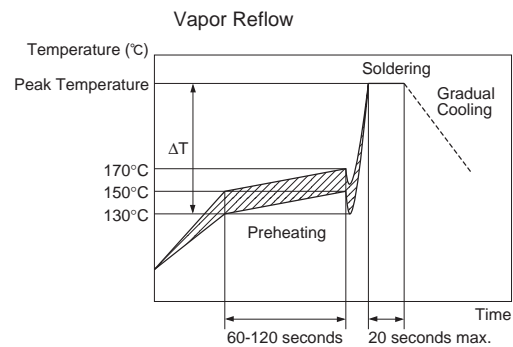
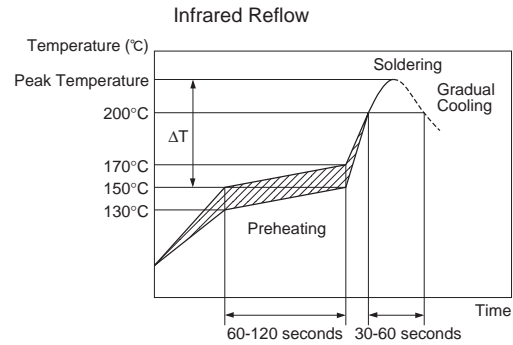

[Allowable Soldering Temperature and Time]

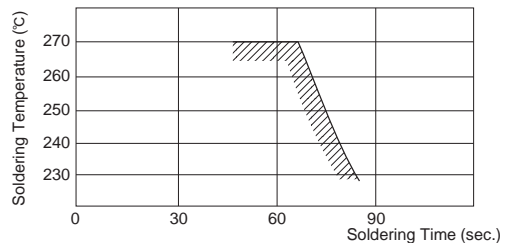

In the case of repeated soldering, the accumulated soldering time must be within the range shown above.

[Optimum Solder Amount for Reflow Soldering]

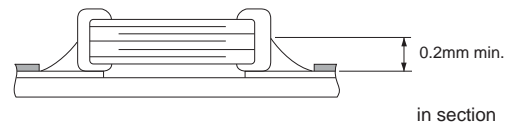

For General Purpose GRM/GRJ Series

Only for Applications

AC250V Type GA2 Series

Safety Standard Certified GA3 Series

Product Information
⚠Caution

⚠Caution

Continued from the preceding page.

5. Flow Soldering

- When components are exposed to sudden heat, their mechanical strength can be decreased due to the extreme temperature changes which can cause flexing and result in internal mechanical damage, which will cause the parts to fail. Additionally, an excessively long soldering time or high soldering temperature results in leaching by the outer electrodes, causing poor adhesion or a reduction in capacitance value due to loss of contact between electrodes and end termination.
- In order to prevent mechanical damage, preheating is required for both the components and the PCB board. Preheating conditions are shown in Table 2. It is required to keep temperature differential between the soldering and the components surface (ΔT) as small as possible.
- When components are immersed in solvent after mounting, be sure to maintain the temperature difference between the component and solvent within the range shown in Table 2.
Do not apply flow soldering to chips not listed in Table 2.

Table 2

Part Number	Temperature Differential
G□□18/21/31	$\Delta T \leq 150^\circ\text{C}$

Recommended Conditions

	Pb-Sn Solder	Lead Free Solder
Peak Temperature	240-250°C	250-260°C
Atmosphere	Air	N ₂

Pb-Sn Solder: Sn-37Pb
 Lead Free Solder: Sn-3.0Ag-0.5Cu

- Optimum Solder Amount for Flow Soldering**
 The top of the solder fillet should be lower than the thickness of components. If the solder amount is excessively large, the risk of cracking is higher during board bending or under any other stressful conditions.

[Standard Conditions for Flow Soldering]

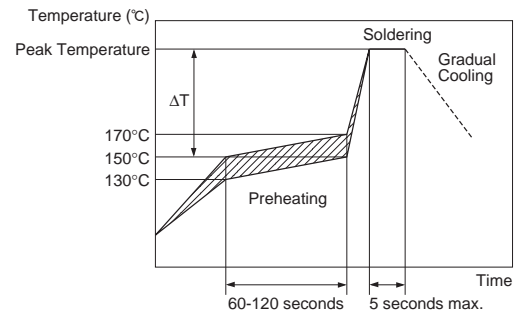

[Allowable Soldering Temperature and Time]

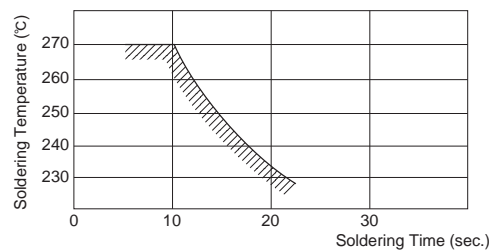

In the case of repeated soldering, the accumulated soldering time must be within the range shown above.

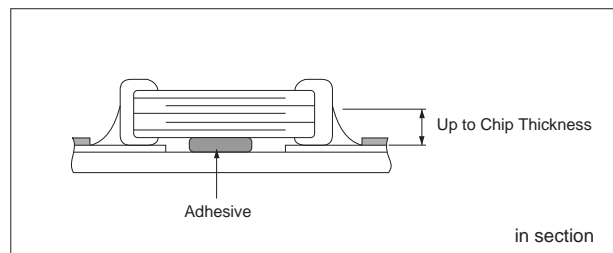

Continued on the following page. ↗

Caution

Continued from the preceding page.

6. Correction with a Soldering Iron

- When sudden heat is applied to the components by use of a soldering iron, the mechanical strength of the components will decrease because the extreme temperature change causes deformations inside the components.

In order to prevent mechanical damage to the components, preheating is required for both the components and the PCB board.

Preheating conditions, (The "Temperature of the Soldering Iron Tip", "Preheating Temperature," "Temperature Differential" between iron tip and the

components and the PCB), should be within the conditions of table 3.

It is required to keep the temperature differential between the soldering Iron and the component's surface (ΔT) as small as possible.

After soldering, do not allow the component/PCB to cool down rapidly.

The operating time for the re-working should be as short as possible. When re-working time is too long, it may cause solder leaching, in turn causing a reduction of the adhesive strength of the terminations.

Table 3

Part Number	Temperature of Soldering Iron tip	Preheating Temperature	Temperature Differential (ΔT)	Atmosphere
G□□18/21/31	350°C max.	150°C min.	$\Delta T \leq 190^\circ\text{C}$	air
G□□32/42/43/52/55	280°C max.	150°C min.	$\Delta T \leq 130^\circ\text{C}$	air

*Applicable for both Pb-Sn and Lead Free Solder.
 Pb-Sn Solder: Sn-37Pb
 Lead Free Solder: Sn-3.0Ag-0.5Cu

- Optimum Solder Amount when re-working Using a Soldering Iron

For sizes smaller than G□□18, the top of the solder fillet should be lower than 2/3 of the thickness of the component or 0.5mm whichever is smaller.

For sizes larger than G□□21, the top of the solder fillet should be lower than 2/3 of the thickness of the component.

If the solder amount is excessive, the risk of cracking is higher during board bending or under any other stressful conditions.

A Soldering iron $\phi 3\text{mm}$ or smaller should be used.

It is also necessary to keep the soldering iron from touching the components during the re-work.

Solder wire with $\phi 0.5\text{mm}$ or smaller is required for soldering.

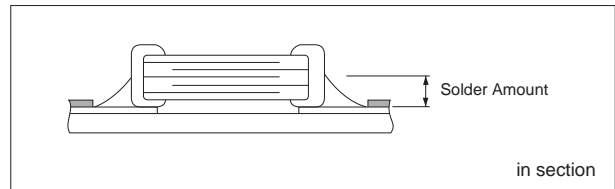

7. Washing

Excessive output of ultrasonic oscillation during cleaning causes PCBs to resonate, resulting in cracked chips or broken solder. Take note not to vibrate PCBs.

FAILURE TO FOLLOW THE ABOVE CAUTIONS MAY RESULT, WORST CASE, IN A SHORT CIRCUIT AND FUMING WHEN THE PRODUCT IS USED.

For General Purpose GRM/GRJ Series

Only for Applications

AC250V Type GA2 Series

Safety Standard Certified GA3 Series

Product Information △Caution

For General Purpose
GRM/GRJ Series

Only for Applications

AC250V Type
GA2 Series

Safety Standard
Certified GA3 Series

Product Information
Notice

Notice

■ Notice (Soldering and Mounting)

1. Construction of Board Pattern

After installing chips, if solder is excessively applied to the circuit board, mechanical stress will cause destruction resistance characteristics to lower. To prevent this, be extremely careful in determining shape and dimension before designing the circuit board diagram.

Construction and Dimensions of Pattern (Example)

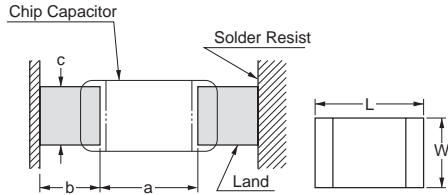

Flow Soldering

L×W	a	b	c
1.6×0.8	0.6-1.0	0.8-0.9	0.6-0.8
2.0×1.25	1.0-1.2	0.9-1.0	0.8-1.1
3.2×1.6	2.2-2.6	1.0-1.1	1.0-1.4

Flow soldering : 3.2×1.6 or less available.

Reflow Soldering

L×W	a	b	c
1.6×0.8	0.6-0.8	0.6-0.7	0.6-0.8
2.0×1.25	1.0-1.2	0.6-0.7	0.8-1.1
3.2×1.6	2.2-2.4	0.8-0.9	1.0-1.4
3.2×2.5	2.0-2.4	1.0-1.2	1.8-2.3
4.5×2.0	2.8-3.4	1.2-1.4	1.4-1.8
4.5×3.2	2.8-3.4	1.2-1.4	2.3-3.0
5.7×2.8	4.0-4.6	1.4-1.6	2.1-2.6
5.7×5.0	4.0-4.6	1.4-1.6	3.5-4.8

(in mm)

Dimensions of Slit (Example)

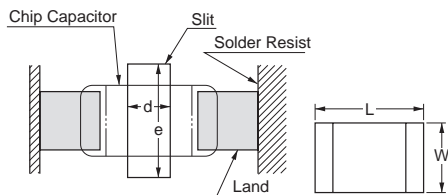

L×W	d	e
1.6×0.8	-	-
2.0×1.25	-	-
3.2×1.6	1.0-2.0	3.2-3.7
3.2×2.5	1.0-2.0	4.1-4.6
4.5×2.0	1.0-2.8	3.6-4.1
4.5×3.2	1.0-2.8	4.8-5.3
5.7×2.8	1.0-4.0	4.4-4.9
5.7×5.0	1.0-4.0	6.6-7.1

(in mm)

Preparing the slit helps flux cleaning and resin coating on the back of the capacitor.

However, the length of the slit design should be as short as possible to prevent mechanical damage in the capacitor.

A longer slit design might receive more severe mechanical stress from the PCB.

Recommended slit design is shown in the Table.

Continued on the following page. ↗

Notice

Continued from the preceding page.

Land Layout to Prevent Excessive Solder

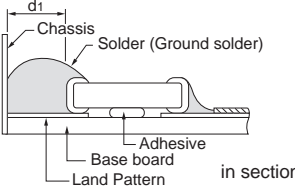
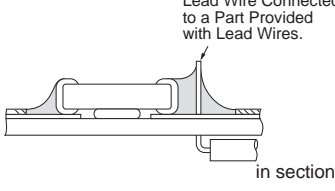
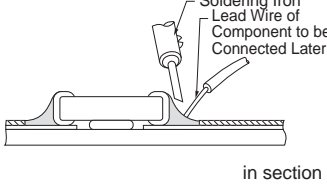
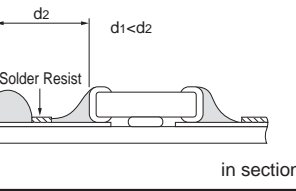
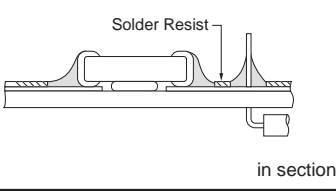
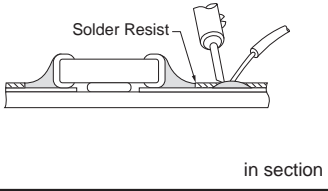
	Mounting Close to a Chassis	Mounting with Leaded Components	Mounting Leaded Components Later
Examples to Be Avoided			
Examples of Improvements by the Land Division			

2. Mounting of Chips

- Thickness of adhesives applied
Keep thickness of adhesives applied (50-105µm or more) to reinforce the adhesive contact considering the thickness of the termination or capacitor (20-70µm) and the land pattern (30-35µm).
- Mechanical shock of the chip placer
When the positioning claws and pick-up nozzle are worn, the load is applied to the chip while positioning is concentrated in one position, thus causing cracks, breakage, faulty positioning accuracy, etc. Careful checking and maintenance are necessary to prevent unexpected trouble.
An excessively low bottom dead point of the suction nozzle imposes great force on the chip during mounting, causing cracked chips. Please set the suction nozzle's bottom dead point on the upper surface of the board.

3. Soldering

(1) Limit of losing effective area of the terminations and conditions needed for soldering.

Depending on the conditions of the soldering temperature and/or immersion (melting time), effective areas may be lost in some parts of the terminations.

To prevent this, be careful in soldering so that any possible loss of the effective area on the terminations will securely remain at a maximum of 25% on all edge length A-B-C-D-A of part with A, B, C, D, shown in the Figure below.

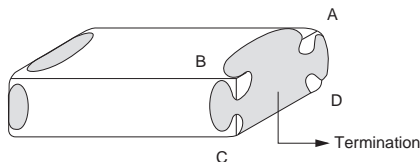

(2) Flux Application

- An excessive amount of flux generates a large quantity of flux gas, causing deteriorated solderability. So apply flux thinly and evenly throughout. (A foaming system is generally used for flow soldering.)
- Flux containing too high a percentage of halide may cause corrosion of the outer electrodes without sufficient cleaning. Use flux with a halide content of 0.2% max.
- Do not use strong acidic flux.
- Do not use water-soluble flux.*
(*Water-soluble flux can be defined as non rosin type flux including wash-type flux and non-wash-type flux.)

(3) Solder

The use of Sn-Zn based solder will deteriorate the reliability of the MLCC. Please contact our sales representative or product engineers on the use of Sn-Zn based solder in advance.

Continued on the following page. 

For General Purpose GRM/GRJ Series

Only for Applications

AC250V Type GA2 Series

Safety Standard Certified GA3 Series

Product Information Notice

Notice

☒ Continued from the preceding page.

4. Cleaning

Please confirm there is no problem in the reliability of the product beforehand when cleaning it with the intended equipment.

The residue after cleaning it might cause a decrease in the surface resistance of the chip and the corrosion of the electrode part, etc. As a result it might cause reliability to deteriorate. Please confirm beforehand that there is no problem with the intended equipment in ultrasonic cleansing.

5. Resin Coating

Please use it after confirming there is no influence on the product with the intended equipment before the resin coating and molding.

A cracked chip might be caused at the cooling/heating cycle by the amount of resin spreading and/or bias thickness.

The resin for coating and molding must be selected as the stress is small when stiffening and the hygroscopic is low as possible.

■ Rating

1. Capacitance change of capacitor

(1) In the case of X7R char.

Capacitors have an aging characteristic, whereby the capacitor continually decreases its capacitance slightly if the capacitor is left on for a long time. Moreover, capacitance might change greatly depending on the surrounding temperature or an applied voltage. Therefore, it is not likely to be suitable for use in a time constant circuit.

Please contact us if you need detailed information.

(2) In the case of any char. except X7R

Capacitance might change a little depending on the surrounding temperature or an applied voltage.

Please contact us if you intend to use this product in a strict time constant circuit.

2. Performance check by equipment

Before using a capacitor, check that there is no problem in the equipment's performance and the specifications.

Generally speaking, CLASS 2 (X7R char.) ceramic capacitors have voltage dependence characteristics and temperature dependence characteristics in capacitance. Therefore, the capacitance value may change depending on the operating condition in the equipment.

Accordingly, be sure to confirm the apparatus performance of receiving influence in a capacitance value change of a capacitor, such as leakage current and noise suppression characteristics.

Moreover, check the surge-proof ability of a capacitor in the equipment, if needed, because the surge voltage may exceed the specific value by the inductance of the circuit.

ISO 9001 Certifications

■ Qualified Standards

The products listed here have been produced by ISO 9001 certified factory.

Plant
Fukui Murata Mfg. Co., Ltd.
Izumo Murata Mfg. Co., Ltd.
Okayama Murata Mfg. Co., Ltd.
Murata Electronics Singapore (Pte.) Ltd.
Beijing Murata Electronics Co., Ltd.
Wuxi Murata Electronics Co., Ltd.

Design assistant tool SimSurfing

SimSurfing



MLCC is now available !

Design assistant tool "SimSurfing" has been updated and you can now find and view any kind of characteristics of MLCCs.

Available function for MLCCs.

- ① Products search
- ② View frequency characteristics (S parameters, Z, R, X, Q, DF, L, C)
- ③ DC voltage bias characteristics (Absolute capacitance/change rate)
- ④ Temperature characteristics (Absolute capacitance/change rate)
- ⑤ AC voltage bias characteristics (Absolute capacitance/change rate)
- ⑥ Download SPICE netlist/ S parameter

① Select the Products

- (1) By part number
- (2) By performance

② View characteristics

Clicking buttons in this area with partnumber selected, you can view any electrical characteristics chart.

③ Data download

You can download SPICE netlist and S parameter files (S2P)

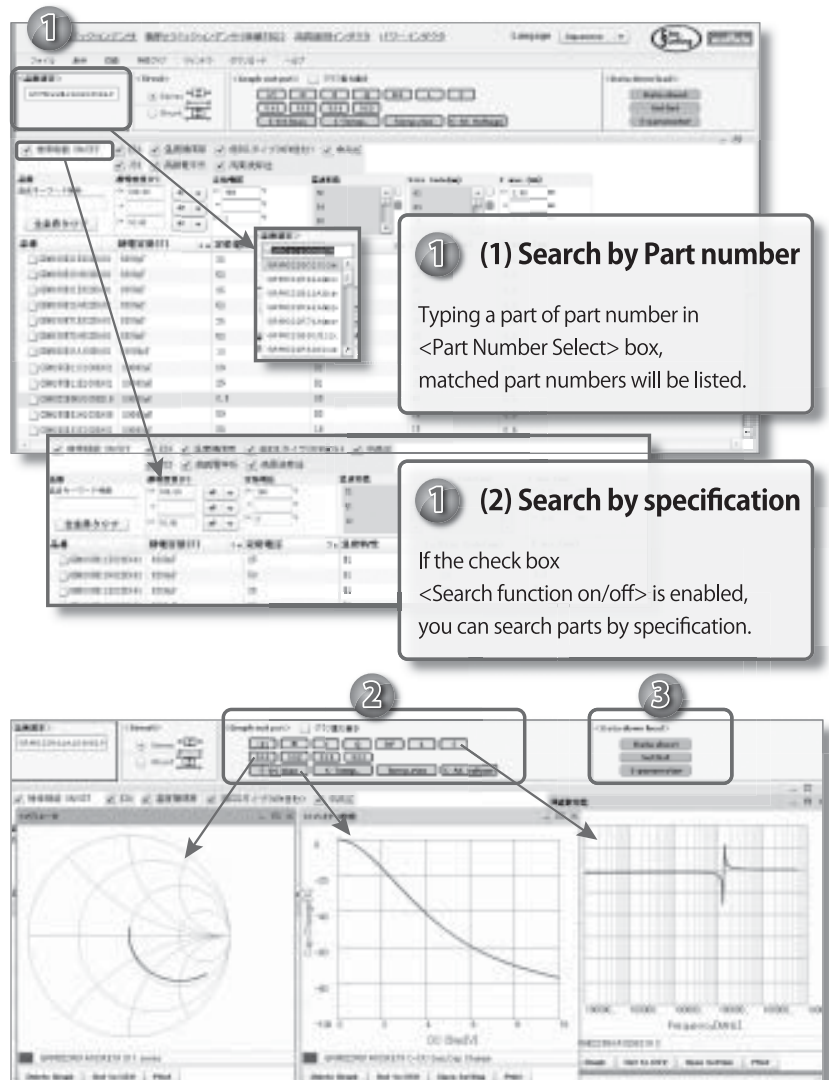

These images are captured at August/2010. Be sure that this software will be updated frequently.

<http://ds.murata.com/software/simsurfing/en-us/mlcc/>

EMICON-FUN!

Please check Murata's newsletter!
 You can learn about electric parts with fun.
http://www.murata.com/products/emicon_fun/

EMICON COLUMN introduce hand-made columns with know-how of capacitors, inductors and EMI suppression filters.
 m's CAFÉ is a relaxing easy essay. Please make yourself at home with EMICON-FUN!

You can register from Murata Manufacturing Web site page TOP.
<http://www.murata.com/>



← This banner is the entrance of register form

EMICON-FUN! Expertly written articles explain the basics of capacitors, inductors and EMI suppression filters.

Capacitor Room
 Introduce quick know-how, and inside story of capacitors

EMICON COLUMN

- Capacitor Room
- Inductor Room
- Noise suppression filter Room
- For the EARTH
- SPECIAL CONTENTS

m's CAFÉ

Recent articles

Oct 10, 2010 **Inductor Room**
 Why do power inductors have two types of rated currents?

EMICON-FUN!
 The index of October 28 issue

- EMI suppression filter Room
- "Say Hello to MURATA BOY"
- Products news
- Introduction of "SimSurfing"
- Questionnaire & Gift

Expertly written articles explain the basics of capacitors, inductors and EMI suppression filters.

EMI suppression filter Room
 What is an EMI filter?

This column aims to provide a basic explanation about noise countermeasures, from "What is EMI?" to the functions and uses of various noise countermeasure parts. This first column starts with the question, "What is an EMI filter?"

http://newsletter.murata.co.jp/c_p702c2aRO88

"Say Hello to MURATA BOY"

Check it out! http://newsletter.murata.co.jp/c_p712c2aRO88

You have a chance to get Murata's original goods each month by answering to a short questionnaire!

*The kind of presents and lottery frequency may be changed without notice.

△Note:

1. Export Control

<For customers outside Japan>

No Murata products should be used or sold, through any channels, for use in the design, development, production, utilization, maintenance or operation of, or otherwise contribution to (1) any weapons (Weapons of Mass Destruction [nuclear, chemical or biological weapons or missiles] or conventional weapons) or (2) goods or systems specially designed or intended for military end-use or utilization by military end-users.

<For customers in Japan>

For products which are controlled items subject to the "Foreign Exchange and Foreign Trade Law" of Japan, the export license specified by the law is required for export.

2. Please contact our sales representatives or product engineers before using the products in this catalog for the applications listed below, which require especially high reliability for the prevention of defects which might directly damage a third party's life, body or property, or when one of our products is intended for use in applications other than those specified in this catalog.

- | | |
|-----------------------------|--|
| ① Aircraft equipment | ② Aerospace equipment |
| ③ Undersea equipment | ④ Power plant equipment |
| ⑤ Medical equipment | ⑥ Transportation equipment (vehicles, trains, ships, etc.) |
| ⑦ Traffic signal equipment | ⑧ Disaster prevention / crime prevention equipment |
| ⑨ Data-processing equipment | ⑩ Application of similar complexity and/or reliability requirements to the applications listed above |

3. Product specifications in this catalog are as of September 2010. They are subject to change or our products in it may be discontinued without advance notice. Please check with our sales representatives or product engineers before ordering. If there are any questions, please contact our sales representatives or product engineers.

4. Please read rating and △CAUTION (for storage, operating, rating, soldering, mounting and handling) in this catalog to prevent smoking and/or burning, etc.

5. This catalog has only typical specifications because there is no space for detailed specifications. Therefore, please approve our product specifications or transact the approval sheet for product specifications before ordering.

6. Please note that unless otherwise specified, we shall assume no responsibility whatsoever for any conflict or dispute that may occur in connection with the effect of our and/or a third party's intellectual property rights and other related rights in consideration of your use of our products and/or information described or contained in our catalogs. In this connection, no representation shall be made to the effect that any third parties are authorized to use the rights mentioned above under licenses without our consent.

7. No ozone depleting substances (ODS) under the Montreal Protocol are used in our manufacturing process.



Murata Manufacturing Co., Ltd.

<http://www.murata.com/>

Head Office

1-10-1, Higashi Kotari, Nagaokakyo-shi, Kyoto 617-8555, Japan
Phone: 81-75-951-9111

International Division

3-29-12, Shibuya, Shibuya-ku, Tokyo 150-0002, Japan
Phone: 81-3-5469-6123 Fax: 81-3-5469-6155 E-mail: intl@murata.co.jp