

MC21605B6W-FPTLW3.3-V2	2 x 16	5mm Character Height	LCD Module
Specification			
Version: 1		Date: 12/03/2021	
Revision			
1	10/03/2021	First Issue	

Display Features			
Character Count	2 x 16		
Appearance	Black on White		
Logic Voltage	3.3V		
Interface	Parallel		
Font Set	English / Japanese		
Display Mode	Transflective		
Character Height	5.23mm		
LC Type	FSTN		
Module Size	85.00 x 36.00 x 13.50 mm		
Operating Temperature	-20°C ~ +70°C		
Construction	COB		
LED Backlight	White		
		Box Quantity	Weight / Display
		---	---

* - For full design functionality, please use this specification in conjunction with the ST7066U + ST7065C specification. (Provided Separately)

Display Accessories	
Part Number	Description
MCCBL1A16SLIP -16DILS-150	16 Way, Single in-line to Dual In-line connector Cable.

Optional Variants		
Fonts	Appearances	Voltage
	Black on Yellow/Green White on Blue	



FEATURES

AVAILABLE OPTIONS	CHARACTERISTICS
DISPLAY FORMAT	16 Characters by 2 Lines
POLARIZER OPTIONS	Positive Transflective
BACKLIGHT TYPE OPTIONS	Edge Type LED Backlight (Long life span version)
BACKLIGHT COLOR OPTIONS	White color
LCD PANEL OPTIONS	FSTN
VIEWING ANGLE OPTIONS	6:00 (Bottom)
TEMPERATURE RANGE OPTIONS	-20°C ~ 70°C, Single Supply Voltage
SUGGESTED DRIVING VOLTAGE	Vlcm = 3.3V Vled = 3.3V
SUGGESTED LED DRIVING MODE	PIN15: LED+, PIN16:LED-
CONTROLLER	ST7066U+ST7065C
FONT MAP CODE	E Version
DRIVING DUTY	1/16
DRIVING BIAS	1/5

MECHANICAL SPECIFICATIONS

OVERALL SIZE	85.0W x 36.0H	mm	THICKNESS	max 13.5	mm
VIEWING AREA	64.5W x 16.4H	mm	HOLE-HOLE	80.0W x 31.0H	mm
CHARACTER SIZE	3.00W x 5.23H	mm	CHARACTER PITCH	0.51W x 0.52H	mm
DOT SIZE	0.56W x 0.61H	mm	DOT PITCH	0.05W x 0.05H	mm

ABSOLUTE MAXIMUM RATINGS

ITEM	SYMBOL	CONDITION	MIN	TYP	MAX	UNIT
POWER SUPPLY (LOGIC)	Vdd	25°C	-0.3	—	7.0	V
POWER SUPPLY (LCD)	V0	25°C	Vdd -13.5	—	Vdd +0.3	V
INPUT VOLTAGE	Vin	25°C	-0.3	—	Vdd +0.3	V
OPERATING TEMPERATURE	Vopr	—	-20	—	70	°C
STORAGE TEMPERATURE	Vstg	—	-30	—	80	°C

ELECTRONIC CHARACTERISTICS *

	ITEM	SYMBOL	CONDITION	MIN	TYP	MAX	UNIT
	INPUT VOLTAGE	Vlcm = Vdd	—	—	3.3	—	V
	SUPPLY CURRENT	Idd	Vdd=3.3V	—	1.5	—	mA
	DRIVING VOLTAGE FOR LCD PANEL	Vlcd = (Vdd - V0)	-20°C	—	—	—	V
			0°C	—	—	—	
			25°C	—	—	—	
			50°C	—	—	—	
			70°C	—	—	—	

LCD CHARACTERISTICS

FOR STN/FSTN TYPE LCD Panel (TA=25 °C, V_{lcd}=5.0V ± 0.5V)

ITEM	SYMBOL	CONDITION	MIN	TYP	MAX	UNIT
VIEWING ANGLE	$\Phi 2 - \Phi 1$	K=4	40	—	—	deg
	θ		60			
CONTRAST RATIO	K	—	6	—	—	—
RESPONSE TIME(RISE)	TR	—	—	150	250	ms
RESPONSE TIME(FALL)	TF	—	—	150	250	ms

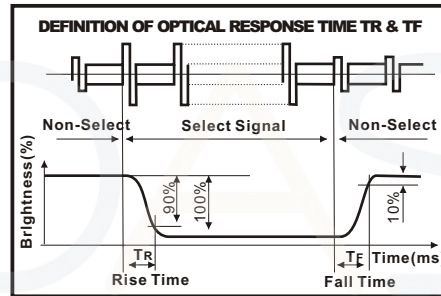
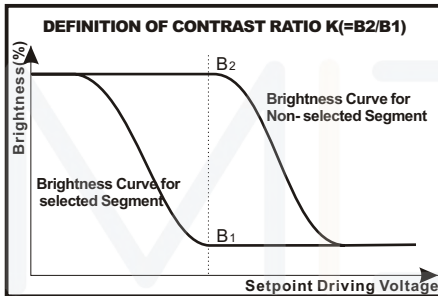
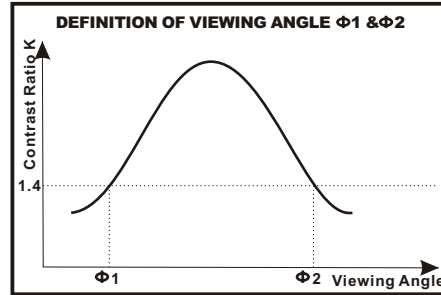
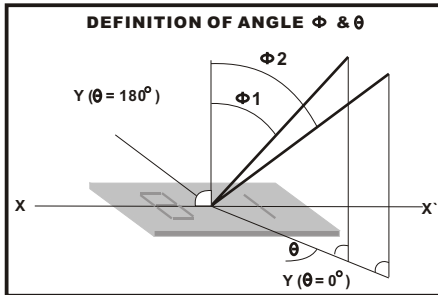

LED CHARACTERISTICS

ITEM	SYMBOL	CONDITION	MIN	TYP	MAX	UNIT
LED FORWARD VOLTAGE	V _f	25 °C	—	3.0	—	V
LED FORWARD CURRENT	I _f	25 °C	—	15	—	mA
LED REVERSE CURRENT	I _r	25 °C V _r =5.0V	—	—	30	μA
LED COLOR RANGE	X coordinate	25 °C I _f = 15mA	0.26	—	0.30	—
	Y coordinate		0.27	—	0.31	—
LED BRIGHTNESS (WITHOUT LCD)	L _v	25 °C I _f = 15mA	—	310	—	cd/m ²
LED BRIGHTNESS UNIFORMITY	L _{vmin} /L _{vmax}	25 °C I _f = 15mA	70	—	—	Ratio
LED LIFE TIME	—	25 °C I _f = 15mA	20K	—	—	Hours



PIN ASSIGNMENT

PIN	SYMBOL	DESCRIPTION	REMARKS
1	Vss	GND	
2	Vdd	Power supply for LCM	+3.3V
3	NC	No connection	
4	RS	Register Select Signal	
5	R/W	Data Read / Write	
6	E	Enable Signal	
7	DB0	Data bus line	
8	DB1	Data bus line	
9	DB2	Data bus line	
10	DB3	Data bus line	
11	DB4	Data bus line	
12	DB5	Data bus line	
13	DB6	Data bus line	
14	DB7	Data bus line	
15	LED+	Power supply for BKL	+3.3V
16	LED-	Power supply for BKL	

BLOCK DIAGRAM

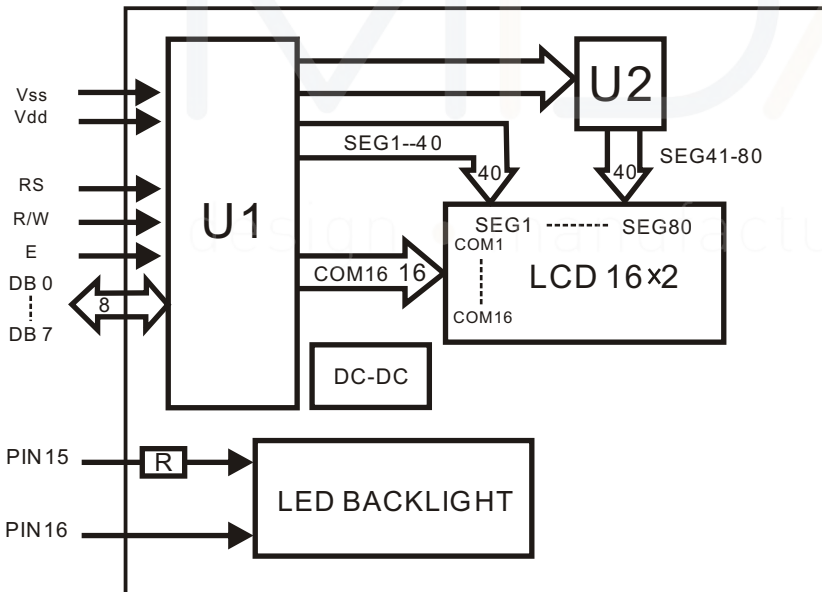

POWER SUPPLY DIAGRAM

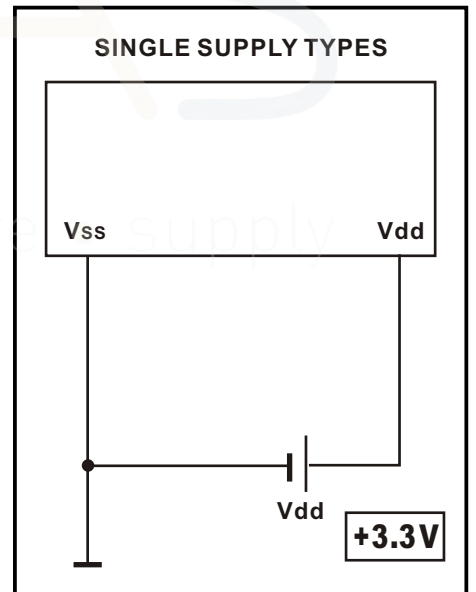

Upper 4bit Lower 4bit	LLLL	LLLH	LLHL	LLHH	LHLL	LHLH	LHHL	LHHH	HLLL	HLLH	HLHL	HLHH	HHLL	HHLH	HHHL	HHHH
LLLL	CG RAM (1)															
LLLH	(2)															
LLHL	(3)															
LLHH	(4)															
LHLL	(5)															
LHLH	(6)															
LHHL	(7)															
LHHH	(8)															
HLLL	(1)															
HLLH	(2)															
HLHL	(3)															
HLHH	(4)															
HHLL	(5)															
HHLH	(6)															
HHHL	(7)															
HHHH	(8)															



