

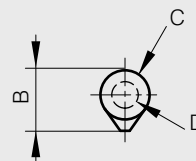

Round top weld-on steel hinges - brass washer

Fixed pin

A	B	C	D	material	finish	part number	pin material	weight
40	10	8	5	steel	raw	14-7-3585	steel	16g
60	12	10	6	steel	raw	14-7-3573	steel	36g
80	16	13	8	steel	raw	14-7-3574	steel	84g
100	20	16	10	steel	raw	14-7-3575	steel	160g
120	20	16	11	steel	raw	14-7-3586	steel	195g
135	22.5	18	12	steel	raw	14-7-3587	steel	270g
150	25.5	20	13	steel	raw	14-7-3576	steel	390g
180	25.5	20	13	steel	raw	14-7-3794	steel	465g
200	29	23	16	steel	raw	14-7-3588	steel	660g
40	10	8	5	steel	raw	14-7-3589	brass	16g
60	12	10	6	steel	raw	14-7-3590	brass	36g
80	16	13	8	steel	raw	14-7-3591	brass	84g
100	20	16	10	steel	raw	14-7-3592	brass	160g
120	20	16	11	steel	raw	14-7-3593	brass	195g
135	22.5	18	12	steel	raw	14-7-3594	brass	270g
150	25.5	20	13	steel	raw	14-7-3595	brass	390g
200	29	23	16	steel	raw	14-7-3596	brass	660g

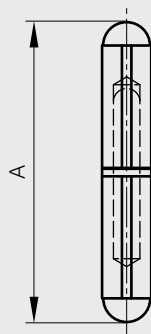

Round top weld-on steel hinges - steel pin - ball bearing

Fixed pin

A	B	C	D	part number	material	finish	weight
104	20	16	10	14-7-3608	steel	raw	162g
124	20	16	11	14-7-3609	steel	raw	197g
141	22.5	18	12	14-7-3610	steel	raw	272g
155.5	25.5	20	13	14-7-3611	steel	raw	392g
206	29	23	16	14-7-3612	steel	raw	662g

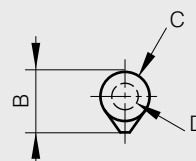
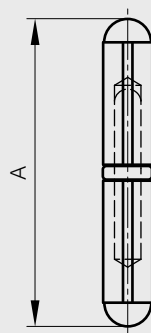



Hinges / Various hinges

Round top weld-on steel hinges - steel pin - brass washer - with grease nipple

Fixed pin

A	B	C	D	part number	material	finish	weight
60	12	10	6	14-7-3796	steel	raw	36g
80	16	13	8	14-7-3786	steel	raw	84g
100	20	16	10	14-7-3787	steel	raw	160g
120	20	16	11	14-7-3788	steel	raw	195g
135	22.5	18	12	14-7-3793	steel	raw	270g
150	25.5	20	13	14-7-3789	steel	raw	390g
180	25.5	20	13	14-7-3790	steel	raw	465g
200	29	23	16	14-7-3791	steel	raw	660g

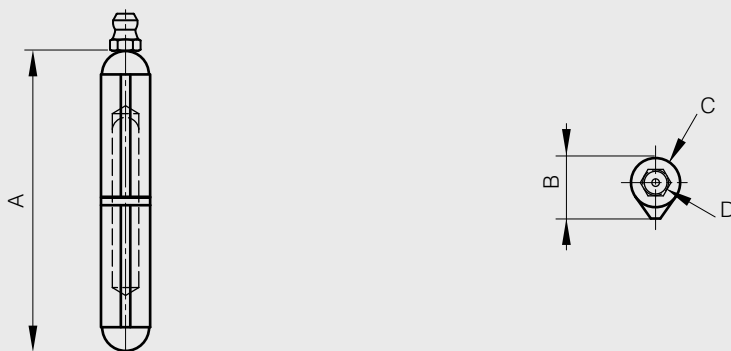

Round top weld-on aluminium hinges - stainless steel pin - stainless steel washer

A	B	C	D	part number	material	finish	weight
60	12	10	6	14-7-3815	alu	raw	20g
80	16	13	8	14-7-3816	alu	raw	40g
100	20	16	10	14-7-3817	alu	raw	75g
120	20	16	11	14-7-3818	alu	raw	93g

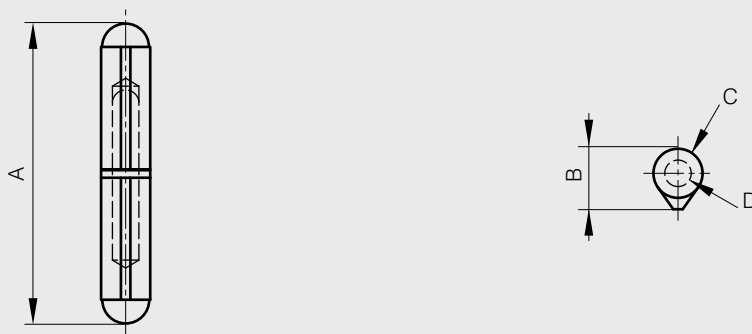



Flat top weld-on steel hinges - brass washer

Fixed pin

A	B	C	D	material	finish	part number	pin material	weight
45	10	8	5	steel	raw	14-7-3583	steel	20g
60	12	10	6	steel	raw	14-7-3569	steel	40g
80	16	13	7	steel	raw	14-7-3570	steel	90g
100	20	16	9	steel	raw	14-7-3571	steel	115g
120	20	16	9	steel	raw	14-7-3603	steel	135g
140	25.5	20	11	steel	raw	14-7-3572	steel	370g
200	29	23	16	steel	raw	14-7-3584	steel	600g
45	10	8	5	steel	raw	14-7-3597	brass	20g
60	12	10	6	steel	raw	14-7-3598	brass	40g
80	16	13	7	steel	raw	14-7-3599	brass	90g
100	20	16	9	steel	raw	14-7-3600	brass	115g
120	20	16	9	steel	raw	14-7-3604	brass	135g
140	25.5	20	11	steel	raw	14-7-3601	brass	370g
200	29	23	16	steel	raw	14-7-3602	brass	680g

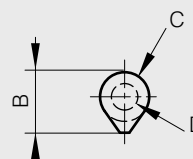
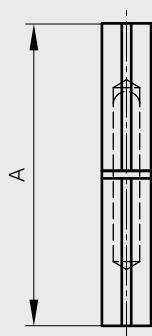

Flat top weld-on steel hinges - steel pin - ball bearing

Fixed pin

A	B	C	D	part number	material	finish	weight
84	16	13	7	14-7-3613	steel	raw	92g
104	20	16	9	14-7-3614	steel	raw	117g
124	20	16	9	14-7-3615	steel	raw	137g
144.5	25.5	20	11	14-7-3606	steel	raw	372g
206	29	23	16	14-7-3616	steel	raw	682g

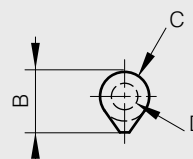
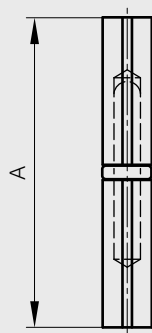



Hinges / Various hinges

Flat top weld-on stainless steel hinges - stainless steel pin - brass washer

Fixed pin

A	B	C	D	part number	material	finish	weight
60	12	10	6	14-7-3693	304 stainless steel	raw	40g
80	16	13	7	14-7-3696	304 stainless steel	raw	90g
100	20	16	9	14-7-3697	304 stainless steel	raw	115g
120	20	16	9	14-7-3698	304 stainless steel	raw	135g

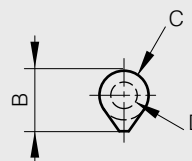
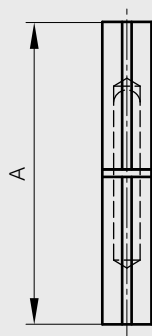

Swivel pin with ball bearing

A	B	C	D	part number	material	finish	weight
63	115	28	10	14-1-3630	steel	raw	482g

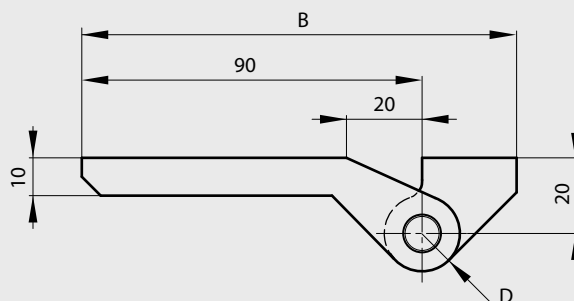
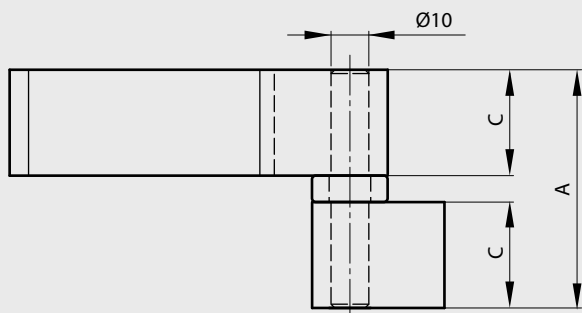

Ball bearing

Ball bearing with inside diameter 11mm for swivel pin 14-1-3630

part number	material	finish
27-7-3647	steel	zinc plated



Flag hinges - steel pin - brass washer

Fixed pin

A	B	C	D	E	part number	material	finish	weight
63	80	4.2	8	15.5	14-7-3634	steel	raw	150g
83.5	80	5.1	8	16	14-7-3635	steel	raw	250g
104	92	5.5	9	17	14-7-3636	steel	raw	390g
124	108	6.5	10	19	14-7-3637	steel	raw	600g
144	108	6.5	10	19	14-7-3638	steel	raw	720g

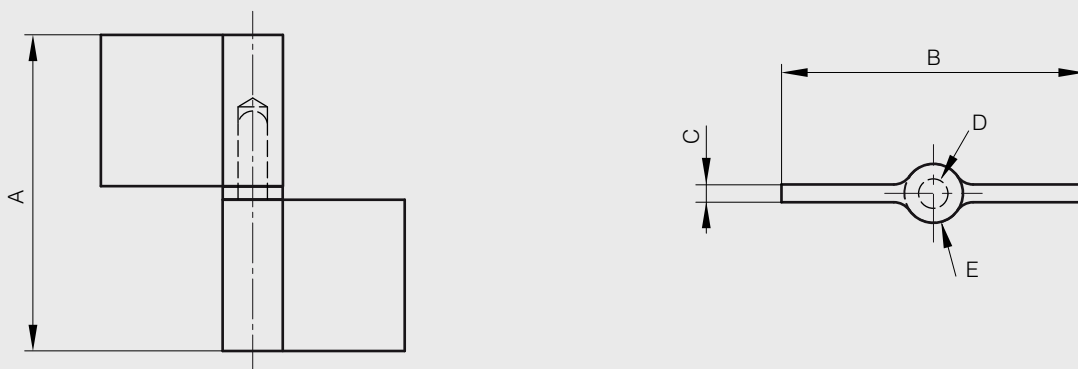

Fixed pin

A	B	C	D	E	note	part number	material	finish	weight
83.5	80	5.1	8	16	type 1 symmetric not shown	14-7-3641	steel	raw	250g
83.5	80	5.1	8	16	type 2 as shown below	14-7-3642	steel	raw	250g
104	92	5.5	9	17	type 1 symmetric not shown	14-7-3643	steel	raw	390g
104	92	5.5	9	17	type 2 as shown below	14-7-3644	steel	raw	390g

