



**AC/DC Converter**  
**Isolation Fly-back Converter PWM method**  
**48 W 12 V**  
**BM2P016T Reference Board**

**User's Guide**

## <High Voltage Safety Precautions>

◇ Read all safety precautions before use

Please note that this document covers only the BM2P016T evaluation board (BM2P016T-EVK-003) and its functions. For additional information, please refer to the datasheet.

**To ensure safe operation, please carefully read all precautions before handling the evaluation board**



Depending on the configuration of the board and voltages used,

**Potentially lethal voltages may be generated.**

Therefore, please make sure to read and observe all safety precautions described in the red box below.

### Before Use

- [1] Verify that the parts/components are not damaged or missing (i.e. due to the drops).
- [2] Check that there are no conductive foreign objects on the board.
- [3] Be careful when performing soldering on the module and/or evaluation board to ensure that solder splash does not occur.
- [4] Check that there is no condensation or water droplets on the circuit board.

### During Use

- [5] Be careful to not allow conductive objects to come into contact with the board.
- [6] **Brief accidental contact or even bringing your hand close to the board may result in discharge and lead to severe injury or death.**

**Therefore, DO NOT touch the board with your bare hands or bring them too close to the board.**

In addition, as mentioned above please exercise extreme caution when using conductive tools such as tweezers and screwdrivers.

- [7] If used under conditions beyond its rated voltage, it may cause defects such as short-circuit or, depending on the circumstances, explosion or other permanent damages.
- [8] Be sure to wear insulated gloves when handling is required during operation.

### After Use

- [9] The ROHM Evaluation Board contains the circuits which store the high voltage. Since it stores the charges even after the connected power circuits are cut, please discharge the electricity after using it, and please deal with it after confirming such electric discharge.
- [10] Protect against electric shocks by wearing insulated gloves when handling.

This evaluation board is intended for use only in research and development facilities and should be handled **only by qualified personnel familiar with all safety and operating procedures.**

We recommend carrying out operation in a safe environment that includes the use of high voltage signage at all entrances, safety interlocks, and protective glasses.

## AC/DC Converter

# Isolation Fly-back Converter PWM method Output 48 W 24 V BM2P016T Reference Board

## BM2P016T-EVK-003

The BM2P016T-EVK-003 evaluation board outputs a 12 V voltage from an input of 90 Vac to 264 Vac. The output current provides up to 4.0 A. The BM2P016T PWM type DC / DC converter IC with 650 V MOSFET is used. The BM2P016T contributes to low power consumption by incorporating a 650 V withstand voltage startup circuit. Using current mode control, cycle-by-cycle current limiting provides excellent performance in bandwidth and transient response. The switching frequency is fixed at 65 kHz. At light loads, frequency reduction achieves high efficiency. Built-in frequency hopping function contributes to low EMI. The low on-resistance 1.4  $\Omega$  · 650 V withstand voltage MOSFET is built in, contributing to low power consumption and easy design.

The optimized EMI design complies with CISPR 22 Class B for noise terminal voltage / radiation emission testing.

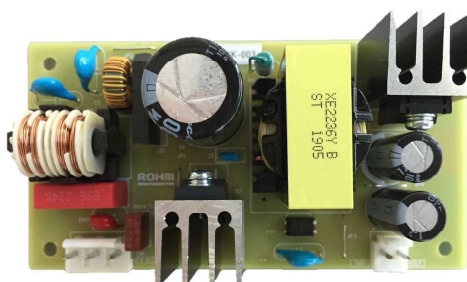

Figure 1. BM2P016T-EVK-003

## Electronics Characteristics

Not guarantee the characteristics, is representative value. Unless otherwise noted:  $V_{IN} = 230 \text{ Vac}$ ,  $I_{OUT} = 3.0 \text{ A}$ ,  $T_a = 25 \text{ }^\circ\text{C}$

Parameter	Min	Typ	Max	Units	Conditions
Input Voltage Range	90	230	264	V	
Input Frequency	47	50/60	63	Hz	
Output Voltage	11.4	12.0	12.6	V	
Maximum Output Power	-	-	48	W	$I_{OUT} = 4 \text{ A}$
Output Current Range <sup>(NOTE1)</sup>	0.0	3.0	4.0	A	
Stand-by Power	-	135	-	mW	$I_{OUT} = 0 \text{ A}$
Efficiency	83.0	86.2	-	%	
Output Ripple Voltage <sup>(NOTE2)</sup>	-	100	-	mVpp	
Operating Temperature Range	-10	+25	+65	$^\circ\text{C}$	

(NOTE1) Please adjust operating time, within any parts surface temperature under 105  $^\circ\text{C}$

(NOTE2) Not include spike noise

**Operation Procedure**

1. Operation Equipment

- (1) AC Power supply 90 ~ 264 Vac, over 50W
- (2) Electronic Load capacity 4.0 A
- (3) Multi meter

2. Connect method

- (1) AC power supply presetting range 90~264 Vac, Output switch is off.
- (2) Load setting under 4 A. Load switch is off.
- (3) AC power supply N terminal connect to the board AC (N) of CN1-2, and L terminal connect to AC (L) of CN1-3.
- (4) Load + terminal connect to VOUT of CN2-2, GND terminal connect to GND of CN2-1
- (5) AC power meter connect between AC power supply and board.
- (6) Output test equipment connects to output terminal
- (7) AC power supply switch ON.
- (8) Check that output voltage is 12V
- (9) Electronic load switch ON
- (10) Check output voltage drop by load connect wire resistance

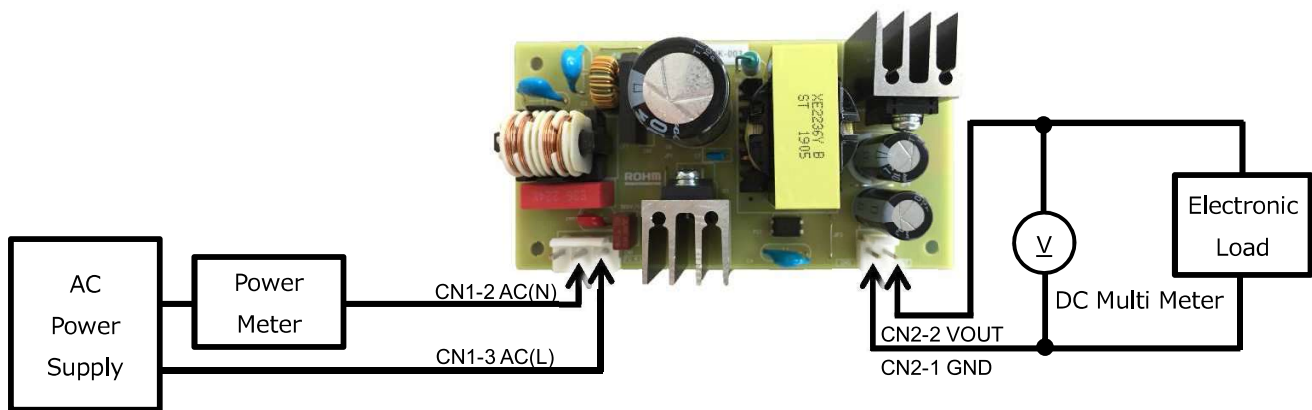

Figure 2. Connection Circuit

**Deleting**

Maximum Output Power  $P_o$  of this reference board is 48 W. The derating curve is shown on the below. If ambient temperature is over 40°C, Please adjust load continuous time by over 105 °C of any parts surface temperature.

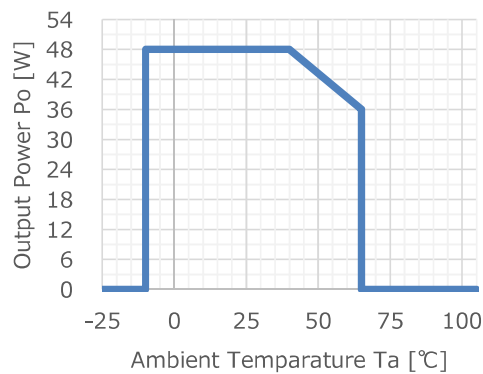

Figure 3. Temperature Derating curve

Application Circuit

BM2P016T-EVK-003 is a fly-back type circuit method, and BM2P016T is used for IC.

The BM2P016T is built-in a high withstand voltage  $V_{DSS}$ : 650 V and a low on resistance  $R_{DS(ON)}$ : 1.4  $\Omega$  Super-Junction MOSFET, contributing to energy saving. The voltage of the output (VOUT) is monitored by a feedback circuit and fed back to the FB terminal of IC1 through a photo coupler. The FADJ pin of IC1 can be used to fix the burst frequency at the burst mode under light load, to prevent the noise at the burst mode.

At startup, the VCC voltage is raised by supplying  $V_{IN}$  to CVCC through the startup circuit (Starter). When the VCC voltage exceeds the UVLO release voltage 13.5V typ., The IC operation starts. When the IC operates, the start-up circuit is turned off and the supply from the DRAIN pin is cut off, contributing to the reduction of standby power.

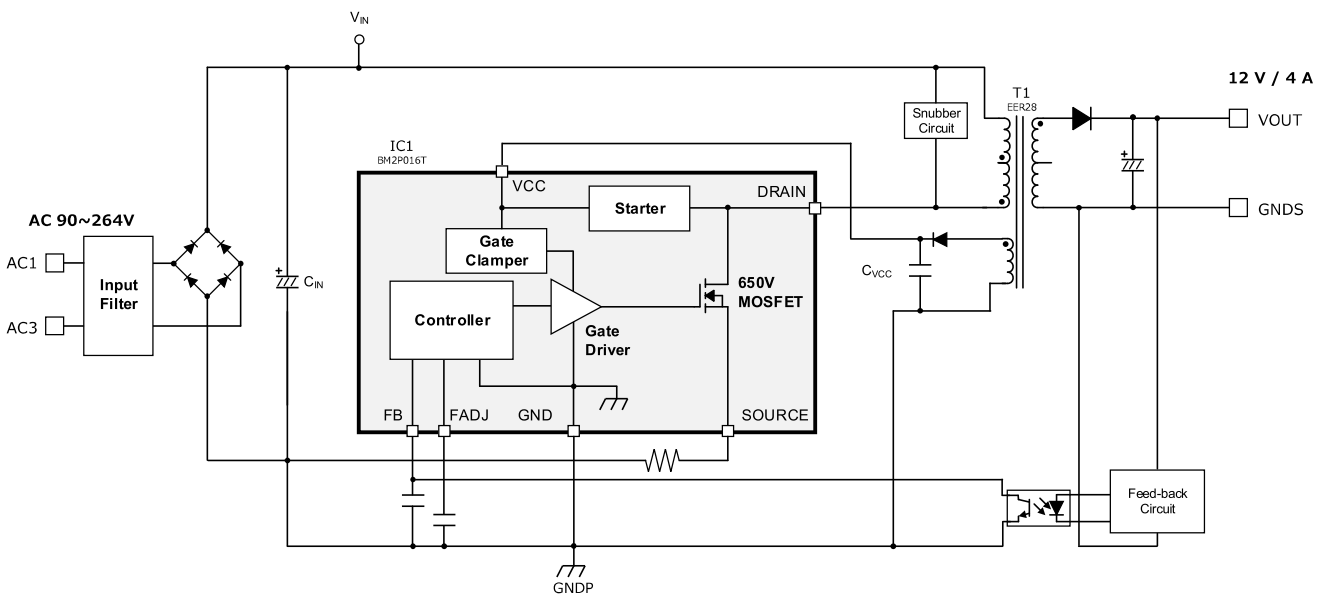

Figure 4. BM2P016T-EVK-003 Application Circuit

**BM2SCQ123T Overview**

**Feature**

- PWM frequency : 65 kHz
- PWM current mode method
- Frequency hopping function
- Burst operation at light load
- Frequency reduction function
- Built-in 650V start circuit
- Built-in 650V switching MOSFET
- VCC pin under voltage protection
- VCC pin over voltage protection
- SOURCE pin Open protection
- SOURCE pin Short protection
- SOURCE pin Leading-Edge-Blanking function
- Per-cycle over current protection circuit
- AC Correction function of over current limiter
- Soft Start Function
- Secondary over current protection circuit

**Key specifications**

- Operation Voltage Range: VCC: 8.9 V ~ 26.0 V  
DRAIN: 650 V(Max)
- Normal Operating Current: 0.95 mA(Typ)
- Burst Operating Current: 0.30 mA(Typ)
- Oscillation Frequency: 65 kHz(Typ)
- Operating Temperature: -40 °C ~ +105 °C
- MOSFET Ron: 1.4 Ω(Typ)

**Application**

AC adapters and household appliance (vacuum cleaners, humidifiers, air cleaners, air conditioners, IH cooking heaters, rice cookers, etc.)

**Dimension**

TO220-7M W(Typ) x D(Typ) x H(Max)  
10.0 mm x 4.6 mm x 25.4 mm



Figure 5. TO220-7M Package

(\*) Product structure: Monolithic integrated circuit mainly made of silicon. No radiation resistant design

(\*) Exceeding the absolute maximum ratings, such as applied voltage and operating temperature range, may lead to deterioration or destruction. Also, the short mode or open mode cannot assume the destruction state. If a special mode that exceeds the absolute maximum rating is assumed, Please consider physical safety measures such as fuses.

Table 1. BM2P016T PIN description

No.	Name	I/O	Function	ESD Diode	
				VCC	GND
1	DRAIN	I/O	MOSFET DRAIN pin	-	-
2	SOURCE	I/O	MOSFET SOURCE pin	✓	✓
3	N.C.	-	Non Connection	-	-
4	FADJ	I	MAX burst frequency setting pin	✓	✓
5	GND	I/O	GND pin	✓	-
6	FB	I	Feed-back signal input pin	✓	✓
7	VCC	I	Power supply input pin	-	✓

Design Overview

1 Important parameter

- $V_{IN}$  : Input Voltage Range AC 90 V ~ 264 Vac (DC 100 V ~ 380 V)
- $V_{OUT}$  : Output Voltage DC 12 V
- $I_{OUT}(typ)$  : Constant Output Current 3.0 A
- $I_{OUT}(max)$  : Maximum Output Current 4.0 A
- $f_{sw}$  : Max Switching Frequency min:61 kHz, typ:65 kHz, max:69 kHz
- $V_{SOURCE}$  : Over Current Detection Voltage min:0.375 V, typ:0.400 V, max:0.425 V

2 Transformer Design

2.1 Setting fly-back voltage VOR

Determine the fly-back voltage VOR and find the turns ratio  $N_p: N_s$ , Duty ratio. With  $V_{IN}(min) = 100 V$  and  $V_F = 1.5 V$ , target VOR to about 100 V. In this case, the turns ratio  $N_p: N_s = 6.9$  determined later.

$$VOR = (V_{OUT} + V_F) \times \frac{N_p}{N_s} = \frac{t_{on}}{t_{off}} \times V_{IN} = 93.2$$

$$\frac{N_p}{N_s} = \frac{VOR}{V_{OUT} + V_F} = \frac{93.2 V}{12 V + 1.5 V} = 6.9$$

$$Duty(max) = \frac{VOR}{V_{IN}(min) + VOR} = \frac{93.2 V}{100 V + 93.2 V} = 0.482$$

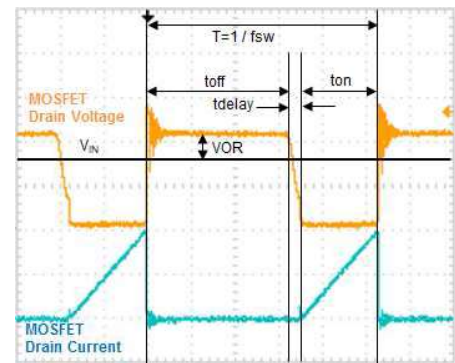

Figure 6. MOSFET Drain Waveform

Set VOR so that Duty is 0.5 or less in consideration of MOSFET loss and so on.

2.2 Selection of operation mode

The PWM driven Fly-back switching regulator transfers power from the primary side to the secondary side using a transformer.

There are three types of transformer operation modes:

- CCM (Continuous Current Mode) : The primary side switching element is turned on before the charging current of the secondary side coil is completely discharged. Since the coil current is continuous.
- BCM (Boundary Current Mode) : The switching element on the primary side is turned on at the same time the discharge of the coil on the secondary side is completed.
- DCM (Dis-continuous Current Mode) : The primary side switching element turns on after the secondary side coil is completely discharged. It is called current discontinuous mode because the coil current is not continuous.

BM2P016 works properly in either CCM or DCM mode. In this design, the transformer is designed to be BCM at a load current of 4 A with an input voltage of DC 260 V (AC conversion: 185 Vac).

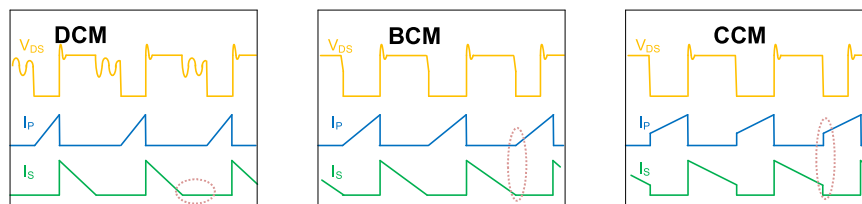

Figure 7. Switching Waveform (MOSFET  $V_{DS}$ ,  $I_P$ ,  $I_S$ )

2 Transformer design -Continued

2.3 Calculation of inductance value

Selecting the optimum inductor value will improve power supply efficiency. The figure below shows the peak current  $I_{PPK}$  of the transformer and the input voltage / output current characteristics of the DC current  $I_{DC}$  at switching ON. Increasing the transformer inductance value reduces the transformer peak current. Low peak current offers benefits such as reduced power dissipation and smaller components. However, when the input voltage is low or the output current is large, the continuous mode CCM is set, and a DC current  $I_{DC}$  is generated. When DC current is generated, switching loss increases, and disadvantages such as deterioration of power supply efficiency and generation of switching noise increase.

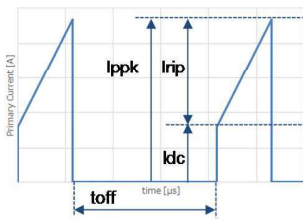

Figure 8. Current of Transfer

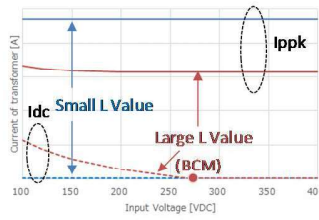

Figure 9. Relation of  $V_{IN}$  vs. Current

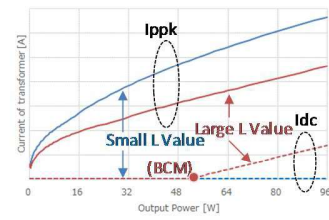

Figure 10. Relation of  $V_{OUT}$  v. Current

Under the condition that the input voltage  $V_{IN} = 260$  Vdc input, the load current  $I_{OUT}(BCM) = 3$  A, and the BCM when the oscillation frequency is 65 kHz, find the primary winding inductance  $L_P$  and secondary winding inductance  $L_S$ .

$$Duty = \frac{V_{OR}}{V_{IN} + V_{OR}} = \frac{93.2 V}{260 V + 93.2 V} = 0.264$$

The secondary side inductance  $L_S$  in the case of becoming BCM is calculated.

$$I_{SPK} = \frac{V_{OUT} + V_F}{L_S} \times t_{OFF} = \frac{V_{OUT} + V_F}{L_S} \times \frac{1 - Duty}{f_{SW}}$$

$$I_{OUT}(BCM) = \frac{1}{2} \times I_{SPK} \times (1 - Duty) = \frac{(V_{OUT} + V_F) \times (1 - Duty)^2}{2 \times L_S \times f_{SW}}$$

$$L_S = \frac{(V_{OUT} + V_F) \times (1 - Duty)^2}{2 \times I_{OUT}(BCM) \times f_{SW}} = \frac{(12 V + 1.5 V) \times (1 - 0.264)^2}{2 \times 4 A \times 65 kHz} = 14.06 \mu H$$

$$L_P = L_S \times \left(\frac{N_P}{N_S}\right)^2 = 14.28 \mu H \times (6.9)^2 = 670.0 \mu H$$

This EVK,  $L_P = 680 \mu H$ ,  $L_S = 14.33 \mu H$ . Calculate the maximum current  $I_{PPK}$  on the primary side and the maximum current  $I_{SPK}$  on the secondary side.



2.3 Calculation of inductance value -Continued

$$I_{SPK} = \frac{V_{OUT} + V_F}{L_S} \times \frac{1 - Duty}{f_{SW}} = \frac{12 V + 1.5 V}{14.33 \mu H} \times \frac{1 - 0.264}{65 kHz} = 10.67 [A]$$

$$I_{PPK} = I_{SPK} \times \frac{N_S}{N_P} = 1.55 [A]$$

2.4 Determination of transformer size

From Po (max) = 48 W, the core size of the transformer selects EER28.

Table 2. Output power and transfer core

Output Power Po(W)	Core size	Core Cross sectional area Ae (mm <sup>2</sup> )
~30	EI25/EE25	41
~50	EFD30	68
~60	EI28/EE28/EER28	86
~80	EI33/EER35	107

(\*) The above values are guidelines. Please check with the transformer manufacturer etc. for details.

2.5 Calculation of primary winding N<sub>P</sub>

The maximum value of the magnetic flux density B (T) of a general ferrite core is 0.4 T @ 100 °C, so B<sub>sat</sub> = 0.35 T.

This EVK, the core cross section Ae = 86.3 mm<sup>2</sup> is selected.

$$N_P > \frac{L_P \times I_{PPK}}{A_e \times B_{sat}} = \frac{680 \mu H \times 1.55 A}{86.3 mm^2 \times 0.35 T} = 34.9 [T]$$

The primary winding number N<sub>P</sub> should be 35 turns or more. In this EVK, N<sub>P</sub> = 62 turns so that it becomes tightly wound from the bobbin size of the transformer.

2.6 Calculation of secondary winding N<sub>S</sub>

The secondary winding number N<sub>S</sub> is expressed by the following formula.

$$\frac{N_P}{N_S} = 6.9 \rightarrow N_S = \frac{62 [T]}{6.9} = 9.0 \rightarrow 9 [T]$$

This EVK, we have N<sub>S</sub> = 9 turns. Also, in order to reduce the leakage inductance, 9 turns are selected from the size of the transformer bobbin so as to be compact winding.

2.7 Calculation of VCC winding N<sub>D</sub>

Assuming VCC = 17 V and V<sub>F\_VCC</sub> = 1 V, N<sub>D</sub> is expressed by the following formula.

$$N_D = N_S \times \frac{V_{CC} + V_{F\_VCC}}{V_{OUT} + V_F} = 9 T \times \frac{17 V + 1.0 V}{12 V + 1.5 V} = 12.0 [T]$$

2.7 Calculation of VCC winding N<sub>D</sub> -Continued

It is assumed that  $N_D = 12$  turns. When driving a MOSFET, set the VCC to 15 V or more because it is necessary to control the Gate voltage. Thun, the transformer specification is as follows.

Table 3. Transformer specification (Reference)

Core	EER28 compatible
$L_P$	680 $\mu$ H
$N_P$	62 turns
$N_S$	9 turns
$N_D$	12 turns

2.8 Transformer design example

Manufacture: Alfatrans Co., LTD

〒541-0059 1-7-2 bakurou-cho, chu-o ku, osaka

<http://www.alphatrans.jp/>

Product: XE2236Y AlphaTrans Corp.

Bobin: FX-2828 10PIN

Core: EER28/28

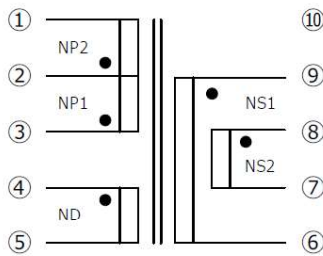

Figure 11. Connection Diagram

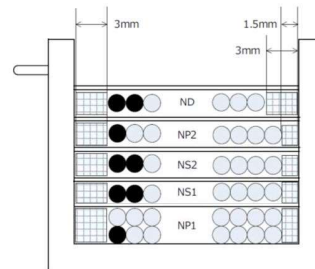

Figure 12. Winding structure diagram

Table 4. Alpha Trans XE2236Y Winding Specification

NO.	WINDING	TERMINAL		WIRE SIZE	TURNS	TAPE LAYERS	WINDING METHOD	NOTE
		START	FINISH					
1	NP1	3	2	2UEW / $\Phi 0.50 * 1$	42	2	COMPACT	
2	NS1	9	6	2UEW / $\Phi 0.55 * 2$	9	2	COMPACT	
3	NS2	8	7	2UEW / $\Phi 0.55 * 2$	9	2	COMPACT	
4	NP2	2	1	2UEW / $\Phi 0.50 * 1$	20	2	COMPACT	
5	ND	4	5	2UEW / $\Phi 0.37 * 2$	12	2	COMPACT	

Inductance ( $L_P$ )            680  $\mu$ H $\pm$ 10 % (100 kHz, 1 V)  
 Leakage Inductance        30  $\mu$ H MAX  
 Withstand Voltage        Pri – Sec            AC1500 V  
    Pri - Core            AC1500 V  
    Sec – Core            AC500 V  
 Insulation resistance       100 M $\Omega$  over (DC500 V)

Design Overview – Continued

3 Main parts selection

3.1 Input Capacitor : C6

The input capacitor value is selected based on Table 5 as a guide. Select according to specifications such as holding time.

Table 5. Input capacitor selection

入力電圧 (Vac)	Cin (μF)
85 ~ 264	2 x P <sub>IN</sub> (W)
180 ~ 264	1 x P <sub>IN</sub> (W)

A capacity equivalent to 48 W/0.84 x 2 = 114 μF is required as P<sub>OUT</sub> = 48 W, and the power supply efficiency is 84%.

This time, it is 100 μF considering the withstand voltage and ripple current of the capacitor. The withstand voltage of the capacitor needs more than the maximum input voltage. 450 V withstand voltage is selected for up to 380 V.

3.2 Resistor of current detection : Rs (R4, R5)

Set the overload protection point of the output by limiting the current flowing to the primary side. The peak current I<sub>PPK</sub> of the primary side at the time of over current detection is calculated.

$$I_{PPK} = I_{SPK} \times \frac{N_s}{N_p}$$

Calculate the peak current I<sub>SSK</sub> on the secondary side at the time of over current detection. The output current in continuous mode is expressed by the following equation, and the load current at overcurrent detection is I<sub>OUT</sub> (LIM).

$$I_{OUT}(LIM) = \left( I_{SPK} - \frac{1}{2} \times \frac{V_{OUT} + V_F}{L_S} \times t_{OFF} \right) \times \frac{t_{OFF}}{T}$$

Calculate on duty and off time t<sub>OFF</sub>.

$$Duty = \frac{V_{OR}}{V_{IN}(min) + V_{OR}} = \frac{93 V}{100 V + 93 V} = 0.482$$

$$t_{OFF} = \frac{1 - Duty}{F_{SW}} = \frac{1 - 0.482}{65 kHz} = 8.35 [\mu s]$$

The secondary peak current I<sub>SSK</sub> is expressed by the following equation. The load current at the time of over-current detection is I<sub>OUT</sub> (LIM): 4.8 A with a 20% margin from the maximum load current I<sub>OUT</sub> (MAX): 4 A.

$$I_{SPK} = \frac{I_{OUT}(LIM)}{t_{OFF} \times F_{SW}} + \frac{1}{2} \times \frac{V_{OUT} + V_F}{L_S} \times t_{OFF} = \frac{4.8 A}{8.35 \mu s \times 65 kHz} + \frac{1}{2} \times \frac{12 V + 1.5 V}{14.33 \mu H} \times 8.35 \mu s = 12.78 [A]$$

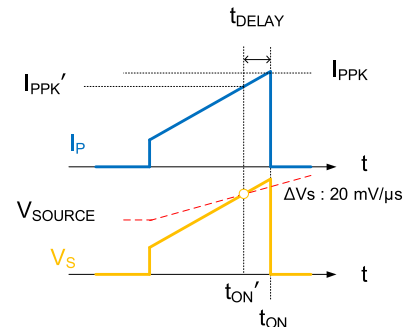

Figure 13. Current detection voltage

## 3.2 Resistor of current detection – Continued

The primary peak current  $I_{PPK}$  is expressed by the following formula.

$$I_{PPK} = I_{SPK} \times \frac{N_S}{N_P} = 12.78 \text{ A} \times \frac{9}{62} = 1.86 \text{ [A]}$$

The primary current is voltage-converted by the sense resistor  $R_S$ , and switching is turned off by exceeding the overcurrent detection voltage. It becomes peak current  $I_{PPK}$  after delay time  $t_{DELAY}$  from over current detection. The peak current  $I'_{PPK}$  at the time of detection is calculated.  $t_{DELAY}$  is 0.1  $\mu\text{s}$ .

$$I'_{PPK} = I_{PPK} - \frac{V_{IN}(min)}{L_P} \times t_{DELAY} = 1.86 \text{ A} - \frac{100 \text{ V}}{680 \mu\text{H}} \times 0.1 \mu\text{s} = 1.85 \text{ A}$$

Calculate the on time  $t_{ON}$  and the over current detection time  $t'_{ON}$ .

$$t_{ON} = \frac{1}{F_{SW}} - t_{OFF} = \frac{1}{65 \text{ kHz}} - 8.35 \mu\text{s} = 7.03 \mu\text{s}$$

$$t'_{ON} = t_{ON} - t_{DELAY} = 7.03 \mu\text{s} - 0.10 \mu\text{s} = 6.93 \mu\text{s}$$

The over-current protection has an AC voltage correction function to compensate for the over-current protection point shift due to the difference in input voltage. Overcurrent detection voltage at 0  $\mu\text{s}$   $V_{SOURCE}$ : 400 mV, AC voltage correction  $\Delta V_S$ : 20 mV /  $\mu\text{s}$ .

The current  $I'_{PPK}$  at the time of over current detection is as follows.

$$I'_{PPK} > \frac{V_{SOURCE} + \Delta V_S \times t_{ON}'}{R_S}$$

The sense resistance  $R_S$  is calculated by the following formula.

$$R_S < \frac{V_{SOURCE} + \Delta V_S \times t_{ON}'}{I_{PPK}'} = \frac{400 \text{ mV} + 20 \text{ mV}/\mu\text{s} \times 6.93 \mu\text{s}}{1.85 \text{ A}} = 0.291 \text{ [\Omega]}$$

The sense resistance  $R_S$  should be 0.291  $\Omega$  or less.

This EVK, the sense resistances ( $R_4$ ,  $R_5$ ) are 0.56  $\Omega$  in parallel and  $R_S$  is 0.28  $\Omega$ .

Also, loss  $P_{R4}$  of the current detection resistor is expressed by the following formula.

$$P_{R14}(rms) = I_{PRMS}^2 \times R_4 = \left[ I_{PPK} \times \sqrt{\frac{Duty(max)}{3}} \right]^2 \times R_4 = \left[ 0.93 \times \sqrt{\frac{0.482}{3}} \right]^2 \times 0.56 = 0.078 \text{ [W]}$$

The MCR18 Series with a rated power of 0.25 W was selected.

3. Main parts selection - Continued

3.6 Diode for VCC : D2

For the VCC diode, a high speed diode is recommended. When  $V_F = 1\text{ V}$ , the reverse voltage  $V_D$  applied to the VCC diode is expressed by the following formula.

$$V_D = V_{CC(max)} + V_F + V_{IN(max)} \times \frac{N_D}{N_P}$$

This IC has VCC OVP function and  $V_{CC\ OVP\ (min)} = 29.0\text{ V}$ .

Make sure that the reverse voltage of the diode does not exceed the  $V_D$  of the diode used even if the VCC voltage rises to VCC OVP.

$$V_D = 29.0\text{ V} + 1.0\text{ V} + 380\text{ V} \times \frac{9\text{ turns}}{62\text{ turns}} = 85.0\text{ V}$$

Select the  $85.0\text{ V} / 0.7\text{ A} \rightarrow 400\text{ V}$  product taking into consideration the margin.

(Example ROHM RRE02VSM4S 400 V 0.2 A)

3.7 Surge voltage limiting resistor for VCC winding : R6

The transformer's leakage inductance (L<sub>leak</sub>) generates a large surge voltage (spike noise) the moment the MOSFET is turned off. This surge voltage may be induced in the VCC winding, and the VCC voltage may rise to affect the VCC over voltage protection of the IC. Insert a limiting resistor R6 (about 5 to 22 Ω) to reduce the surge voltage induced in the VCC winding.

Regarding the rise of the VCC voltage, check it in the state of being incorporated in the product. This EVK, 10Ω was selected.

3.8 Capacitor for VCC : C10

The VCC capacitor  $C_{VCC}$  is required to stabilize the VCC voltage of the IC. The recommended capacity is 4.7 μF to 22 μF.

Figure 15 shows the relationship between start-up time and VCC capacitor value. This time, 10 μF / 35 V was selected.

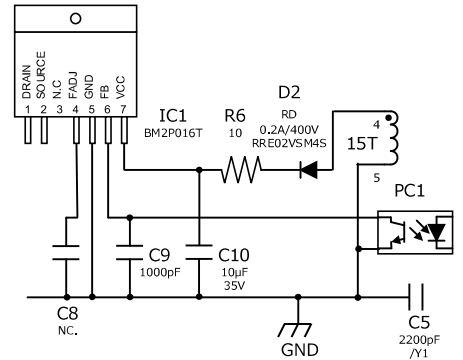

Figure 14. IC peripheral circuit

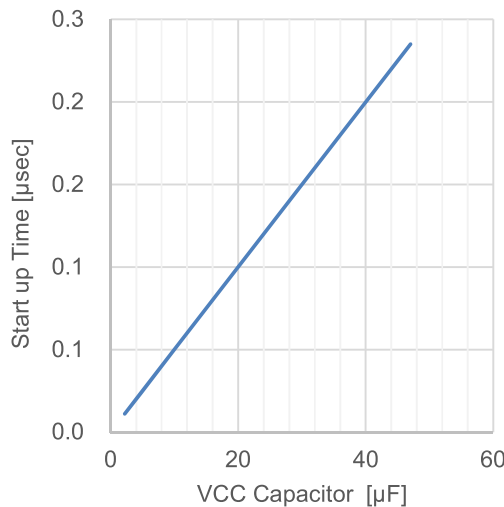

Figure 15. Start-up Time(Reference)

3. Main parts selection – Continued

3.8 Capacitor for FB terminal : C9

C9 is a stabilization capacitor for the FB pin (1000 pF to 0.01 μF is recommended).

3.9 Snubber circuit : C11, R7, R8, D1

The transformer leakage inductance (L<sub>LEAK</sub>) generates a large surge voltage (spike noise) the moment the MOSFET is turned off. This surge voltage is applied between the drain and source of the MOSFET, and in the worst case, the MOSFET may be destroyed. An RCD snubber circuit is recommended to suppress this surge voltage.

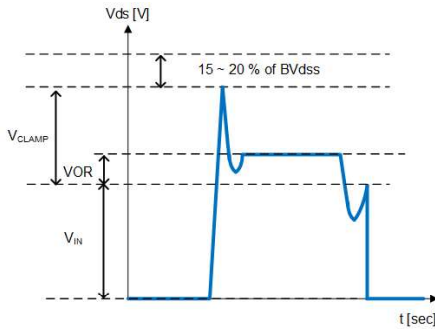

Figure 16. MOSFET Drain Voltage waveform

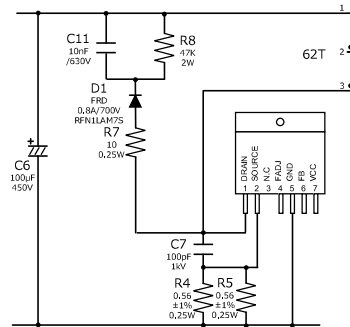

Figure 17. Snubber circuit

i. Determination of clamp voltage (V<sub>CLAMP</sub>) and clamp Ripple voltage (V <sub>RIPPLE</sub>)

The clamp voltage is determined by taking into consideration the margin from the breakdown voltage of the MOSFET.

$$V_{CLAMP} = 650 \text{ V} \times 0.8 = 520 \text{ V}$$

Set the clamp ripple voltage (V <sub>RIPPLE</sub>) to about 50 V.

ii. Determination of snubber resistance: R8

スナバ抵抗は、以下の条件を満たすように選定します。

$$R_8 < 2 \times V_{CLAMP} \times \frac{V_{CLAMP} - V_{OR}}{L_{LEAK} \times I_P^2 \times f_{SW}(max)}$$

Then, L<sub>LEAK</sub> is 30 μH from the specification of the transformer.

The primary side peak current when P<sub>OUT</sub> = 48 W, V<sub>IN</sub> (max) = 380 V: I<sub>PPK</sub> is calculated from the following formula.

First, calculate the on duty and off time t<sub>OFF</sub>.

$$Duty = \frac{V_{OR}}{V_{IN}(max) + V_{OR}} = \frac{93 \text{ V}}{380 \text{ V} + 93 \text{ V}} = 0.197$$

$$t_{OFF} = \frac{1 - Duty}{F_{SW}} = \frac{1 - 0.197}{65 \text{ kHz}} = 12.35 \text{ } [\mu\text{s}]$$

## 3.9 Snubber circuit - Continued

The secondary peak current  $I_{SSK}$  is expressed by the following formula. The load current at the time of overcurrent detection is the maximum load current  $I_{OUT}$  (MAX): 4 A.

$$I_{SPK} = \frac{I_{OUT}(LIM)}{t_{OFF} \times F_{SW}} + \frac{1}{2} \times \frac{V_{OUT} + V_F}{L_S} \times t_{OFF} = \frac{4.0 \text{ A}}{12.35 \mu\text{s} \times 65 \text{ kHz}} + \frac{1}{2} \times \frac{12 \text{ V} + 1.5 \text{ V}}{14.33 \mu\text{H}} \times 12.35 \mu\text{s} = 10.80 \text{ [A]}$$

The primary peak current  $I_{PPK}$  is expressed by the following formula.

$$I_{PPK} = I_{SPK} \times \frac{N_S}{N_P} = 10.80 \text{ A} \times \frac{9}{62} = 1.57 \text{ [A]}$$

Thus, the snubber resistance:  $R_8$  is expressed by the following formula.

$$R_8 < 2 \times V_{CLAMP} \times \frac{V_{CLAMP} - V_{OR}}{L_{LEAK} \times I_P^2 \times f_{SW}(max)} = 2 \times 520 \text{ V} \times \frac{520 \text{ V} - 93 \text{ V}}{30 \mu\text{H} \times 1.57^2 \text{ A} \times 65 \text{ kHz}} = 92.39 \text{ [k}\Omega\text{]}$$

In fact, due to the influence of the MOSFET, not according to this equation, the snubber resistance of 47 k $\Omega$  is selected from actual device evaluation. Snubber resistance loss:  $P_{R_8}$  is expressed by the following formula.

$$P_{R_8} = \frac{(V_{CLAMP} - V_{IN})}{R_8} = \frac{(520 \text{ V} - 380 \text{ V})^2}{47 \text{ k}\Omega} = 0.42 \text{ [W]}$$

Consider a margin and set it to 2 W or more.

## iii. Determination of snubber capacitor: C10

The snubber capacitor is selected to meet the following conditions.

$$C_{10} > \frac{V_{CLAMP}}{V_{RIPPLE} \times f_{SW}(min) \times R_8} = \frac{540 \text{ V}}{50 \text{ V} \times 65 \text{ kHz} \times 47 \text{ k}\Omega} = 3.54 \text{ [nF]}$$

The snubber capacitor is 10 nF. The voltage applied to C10 is 540 V-380 V = 160 V. considering to the margin and make it 200 V or more. This time, the 630 V withstand voltage is selected.

## iv. Determination of snubber capacitor: D1

Use a fast recovery diode for the snubber diode. Make the breakdown voltage higher than the  $V_{ds}$  (max) of the MOSFET. Surge voltage is affected by the pattern of the board as well as the transformer's leakage inductance. Check the  $V_{ds}$  voltage with the product incorporated, and adjust the snubber circuit as required.

3.10 Diode for output rectification : D4

Use a high speed diode (Schottky barrier diode, fast recovery diode) as the output rectification diode. Assuming that the reverse voltage applied to the output diode is  $V_F = 1.5 \text{ V}$  and  $V_{OUT} = 12.0 \text{ V}$ , the reverse voltage  $V_D$  applied to the diode of D4 is expressed by the following formula.

$$V_D = V_{OUT} + V_F + V_{IN(max)} \times \frac{N_S}{N_P} = 12.0 \text{ V} + 1.5 \text{ V} + 380 \text{ V} \times \frac{9 \text{ turns}}{62 \text{ turns}} = 68.7 \text{ [V]}$$

Select a 100 V product considering the margin.

The current  $I_S$  (rms) flowing through the output diode is expressed by the following equation.

$$I_S(rms) = I_{SPK} \times \sqrt{\frac{1 - Duty}{3}} = 10.8 \text{ A} \times \sqrt{\frac{1 - 0.197}{3}} = 5.59 \text{ [A]}$$

This EVK, 20 A, 100 V, TO-220 package products was selected. (Example: ROHM RB218T100NZ) It is recommended to use voltage margin less than 70% and current less than 50%. Check the temperature rise with the product incorporated in the product, re-examine the parts if necessary, and dissipate the heat from the heat sink.

3.11 Capacitor for output : C12,C13,C14

The output capacitor is determined by the Peak-to-Peak ripple voltage ( $\Delta V_{pp}$ ) and the ripple current that are acceptable at the output load. When the MOSFET is on, the output diode is off. At this time, current is supplied from the output capacitor to the load. When the MOSFET is off, the output diode is on, charging the output capacitor and also providing the load current. Assuming that  $\Delta V_{PP} = 200 \text{ mV}$  under the condition ( $V_{IN} = 100 \text{ V}$ ,  $P_{OUT} = 48 \text{ W}$ ) calculated by the transformer calculation,

$$Z_C < \frac{\Delta V_{PP}}{I_{SPK}} = \frac{200 \text{ mV}}{10.8 \text{ A}} = 18.5 \text{ [m}\Omega\text{]}$$

The impedance is specified at 100 kHz for general electrolytic capacitors for switching power supplies (low impedance products), so convert to 65 kHz.

$$Z_C < 18.5 \text{ m}\Omega \times \frac{64 \text{ kHz}}{100 \text{ kHz}} = 12.0 \text{ [m}\Omega\text{]}$$

Also, the ripple current  $I_C$  (rms) to the capacitor is expressed by the following formula.

$$I_C(rms) = \sqrt{I_S(rms)^2 - I_{OUT}^2} = \sqrt{5.59^2 - 4.00^2} = 3.90 \text{ [Arms]}$$

The withstand voltage of the capacitor should be 80% derating as a guide to the output voltage.  $12 \text{ V} / 0.8 = 15 \text{ V}$  or more.

This EVK time, low impedance type 25 V, 1000  $\mu\text{F}$  for switching power supply, rated ripple current 2.8 A x 2 parallel: 25ZLJ1000M10X20: Rubycon. Check the actual Ripple voltage and Ripple current on the actual device.

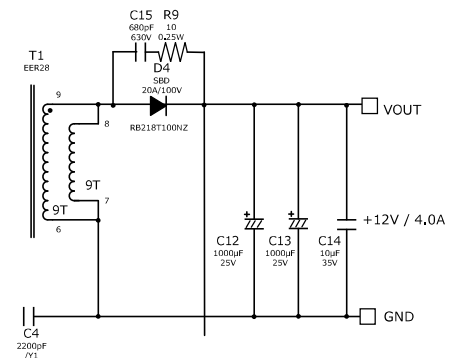

Figure 18 Output peripheral circuit



3. Main parts selection - Continued

3.12 Output voltage setting resistor: R10,R11,R12

The output voltage is set by the following formula

$$V_{OUT} = \left(1 + \frac{R10 + R11}{R12}\right) \times V_{ref}$$

Set the feedback current  $I_{BIAS}$  flowing to R12 at 0.1 mA to 1.0 mA.

Assuming that  $I_{BIAS} = 0.25 \text{ mA}$ , and the reference voltage

$V_{REF} = 2.485 \text{ V}$  of the shunt regulator IC2, the resistance value of R12 is

$$R12 = \frac{V_{REF}}{I_{BIAS}} = \frac{2.485 \text{ V}}{0.25 \text{ mA}} = 9.9 \text{ [k}\Omega\text{]}$$

This EVK, select R12: 10 kΩ.

The combined resistance of the feedback resistors (R10 + R11 + R12) is

$$R10 + R11 + R12 = \frac{V_{OUT}}{I_{BIAS}} = \frac{12 \text{ V}}{0.25 \text{ mA}} = 48 \text{ [k}\Omega\text{]}$$

This EVK, R10 = 33 kΩ and R11 = 5.6 kΩ are selected. The theoretical value of the output voltage is as follows.

$$V_{OUT} = \left(1 + \frac{33 \text{ k}\Omega + 5.6 \text{ k}\Omega}{10 \text{ k}\Omega}\right) \times 2.485 \text{ V} = 12.08 \text{ V}$$

3.13 Control circuit adjustment: R13,R14,R15,C16

R14 is the dark current setting resistor for shunt regulator IC2. The current value  $I_{min}$  for stable operation of the shunt regulator is 1.2 mA according to the data sheet of the IC. This current is the combined current of R13 and the photo coupler's  $I_F$ . Since the voltage applied to R14 is the  $V_F$  of the photo coupler, assuming that the  $V_F$  of the photo coupler is 1.1 V,

$$R14 < \frac{V_F}{I_{min}} = \frac{1.1 \text{ V}}{1.2 \text{ mA}} = 0.92 \text{ [k}\Omega\text{]}$$

This EVK, R14 = 1.0 kΩ is selected.

R13 is a control circuit current limiting resistor. Adjust with 300 to 2.2 kΩ.

This EVK, R13 = 1.0 kΩ is selected.

R15 and C16 are phase compensation circuits. Adjust with the actual board as R15 = 1 k to 30 kΩ, C16 = 0.1 μF or so.

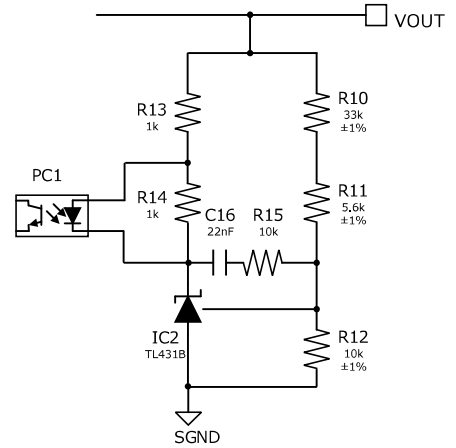

Figure 19. Feed-back circuit

Design Overview – Continued

4 EMI measures

Check the following as EMI measures.

(\*)The constant is a reference value. Adjust by the influence of noise.

•Input filter

Two common mode filters are used. The LF1 is used for the low frequency range, and the LF2 is used for the high frequency range.

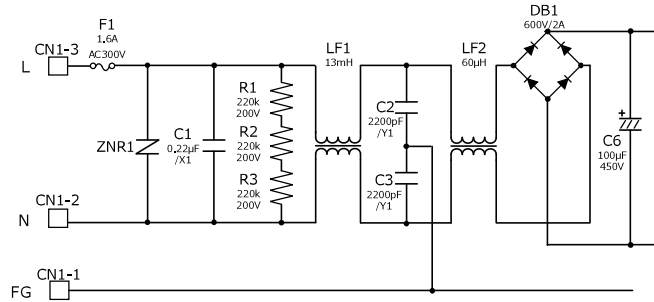

Figure 20. Input filter circuit

•Capacitor between primary and secondary side (C4 : Y-Cap 2200 pF around)

•RC snubber circuit of secondary side rectification diode

An RC snubber circuit is added as a measure against radiated emissions.

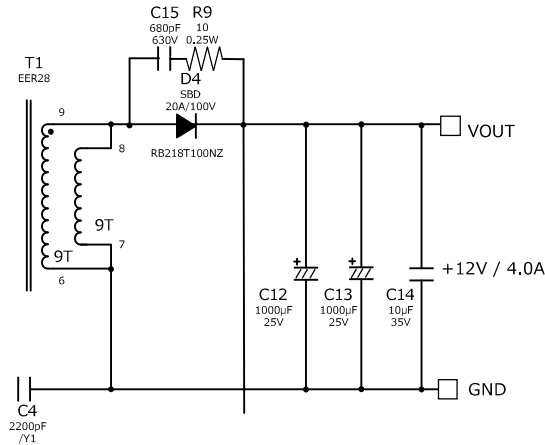

Figure 21. RC snubber circuit of secondary side rectification diode

Performance Data

Load Regulation

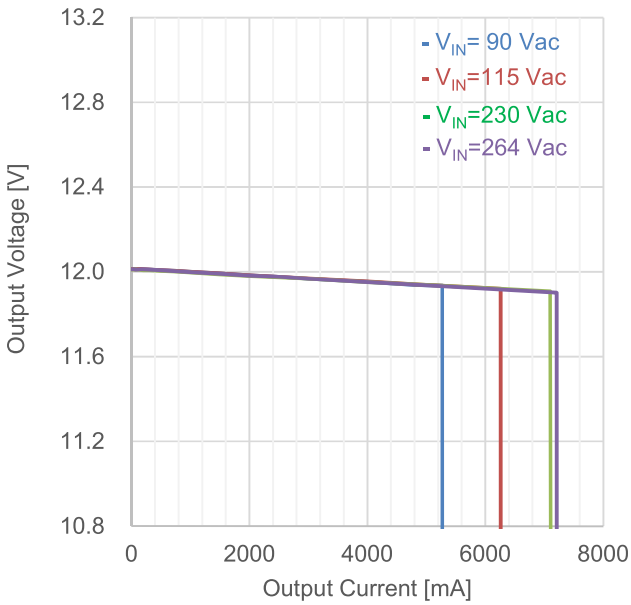

Figure 22. Load Regulation ( $I_{OUT}$  vs  $V_{OUT}$ )

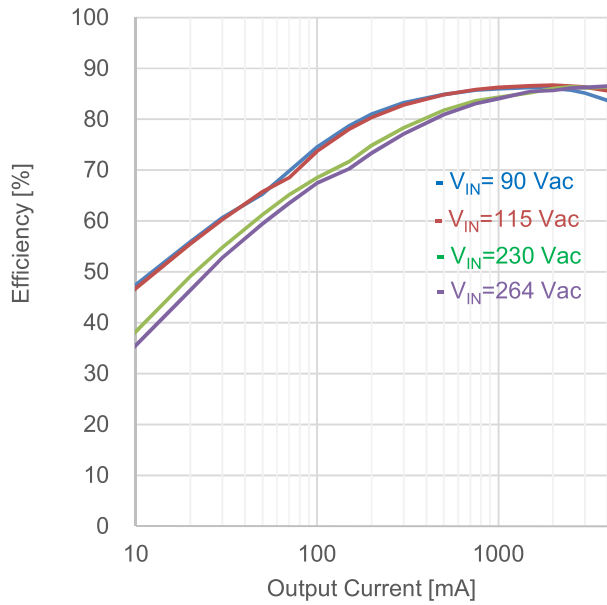

Figure 23. Load Regulation ( $I_{OUT}$  vs Efficiency)

Table 6-1. Load Regulation ( $V_{IN}=100$  Vac)

$I_{OUT}$	$V_{OUT}$	Efficiency
1.0 A	11.995 V	85.74 %
2.0 A	11.978 V	86.17 %
3.0 A	11.962 V	85.48 %
4.0 A	11.945 V	84.48 %

Table 6-2. Load Regulation ( $V_{IN}=230$  Vac)

$I_{OUT}$	$V_{OUT}$	Efficiency
1.0 A	11.997 V	84.31 %
2.0 A	11.981 V	86.04 %
3.0 A	11.967 V	86.18 %
4.0 A	11.952 V	86.30 %

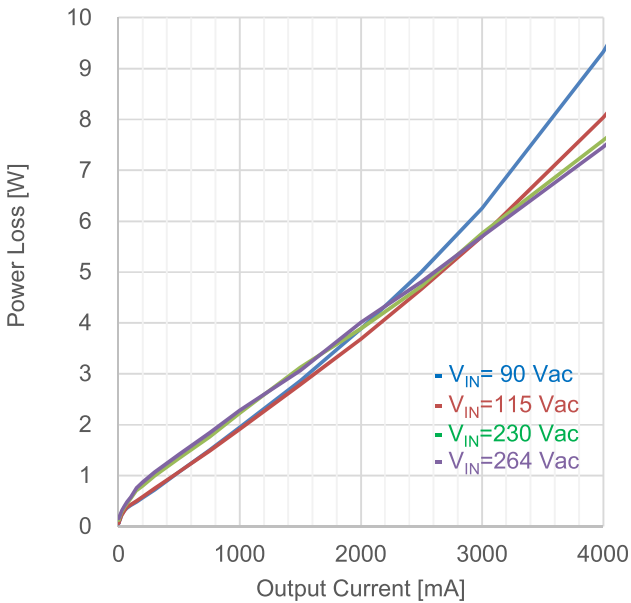

Figure 24. Load Regulation ( $I_{OUT}$  vs  $P_{LOSS}$ )

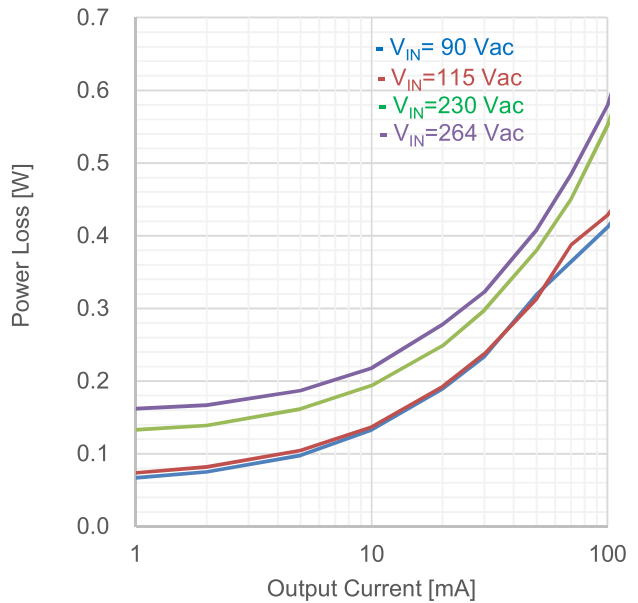

Figure 25. Load Regulation ( $I_{OUT}$  vs  $P_{LOSS}$ )

Performance Data – Continued

Table 7-1. Load Regulation: V<sub>IN</sub>=90 Vac

V <sub>IN</sub> [Vac]	P <sub>IN</sub> [W]	V <sub>OUT</sub> [V]	I <sub>OUT</sub> [mA]	P <sub>OUT</sub> [W]	P <sub>LOSS</sub> [W]	Efficiency [%]
90	0.06	12.014	0	0.000	0.058	0.00
90	0.08	12.014	1	0.012	0.067	15.21
90	0.10	12.014	2	0.024	0.075	24.27
90	0.16	12.014	5	0.060	0.098	38.02
90	0.25	12.014	10	0.120	0.133	47.49
90	0.43	12.014	20	0.240	0.190	55.88
90	0.59	12.013	30	0.360	0.234	60.67
90	0.92	12.013	50	0.601	0.319	65.29
90	1.21	12.013	70	0.841	0.364	69.79
90	1.61	12.014	100	1.201	0.412	74.48
90	2.29	12.013	150	1.802	0.487	78.72
90	2.97	12.012	200	2.402	0.565	80.97
90	4.33	12.011	300	3.603	0.726	83.24
90	7.08	12.008	500	6.004	1.072	84.85
90	10.51	12.004	750	9.003	1.502	85.70
90	13.95	12.000	1000	12.000	1.952	86.01
90	20.85	11.992	1500	17.988	2.864	86.27
90	27.85	11.984	2000	23.968	3.882	86.06
90	34.94	11.976	2500	29.940	4.999	85.69
90	42.16	11.968	3000	35.904	6.256	85.16
90	57.14	11.953	4000	47.812	9.328	83.68
90	69.87	11.939	4800	57.307	12.563	82.02
90	78.50	11.935	5270	62.897	15.603	80.12
90	0.05	0.000	5280	0.000	0.050	0.00

Table 7-2. Load Regulation: V<sub>IN</sub>=100 Vac

V <sub>IN</sub> [Vac]	P <sub>IN</sub> [W]	V <sub>OUT</sub> [V]	I <sub>OUT</sub> [mA]	P <sub>OUT</sub> [W]	P <sub>LOSS</sub> [W]	Efficiency [%]
100	0.02	12.012	0	0.000	0.016	0.00
100	0.08	12.012	1	0.012	0.067	15.21
100	0.10	12.012	2	0.024	0.076	24.02
100	0.16	12.012	5	0.060	0.101	37.30
100	0.26	12.012	10	0.120	0.137	46.74
100	0.43	12.012	20	0.240	0.193	55.48
100	0.60	12.012	30	0.360	0.238	60.26
100	0.92	12.011	50	0.601	0.315	65.56
100	1.22	12.011	70	0.841	0.376	69.09
100	1.62	12.010	100	1.201	0.422	74.00
100	2.31	12.009	150	1.801	0.505	78.12
100	2.99	12.009	200	2.402	0.588	80.33
100	4.36	12.007	300	3.602	0.758	82.62
100	7.09	12.004	500	6.002	1.088	84.65
100	10.54	12.000	750	9.000	1.540	85.39
100	13.99	11.995	1000	11.995	1.995	85.74
100	20.86	11.987	1500	17.981	2.880	86.20
100	27.80	11.978	2000	23.956	3.844	86.17
100	34.89	11.970	2500	29.925	4.965	85.77
100	41.98	11.962	3000	35.886	6.094	85.48
100	56.56	11.945	4000	47.780	8.780	84.48
100	68.68	11.931	4800	57.269	11.411	83.38
100	84.61	11.918	5790	69.005	15.605	81.56
100	0.07	0.000	5800	0.000	0.067	0.00

Table 7-3. Load Regulation: V<sub>IN</sub>=115 Vac

V <sub>IN</sub> [Vac]	P <sub>IN</sub> [W]	V <sub>OUT</sub> [V]	I <sub>OUT</sub> [mA]	P <sub>OUT</sub> [W]	P <sub>LOSS</sub> [W]	Efficiency [%]
115	0.06	12.014	0	0.000	0.064	0.00
115	0.09	12.014	1	0.012	0.074	13.97
115	0.11	12.013	2	0.024	0.082	22.67
115	0.17	12.013	5	0.060	0.105	36.40
115	0.26	12.013	10	0.120	0.137	46.74
115	0.43	12.013	20	0.240	0.193	55.49
115	0.60	12.013	30	0.360	0.238	60.27
115	0.91	12.012	50	0.601	0.313	65.71
115	1.23	12.012	70	0.841	0.387	68.47
115	1.63	12.014	100	1.201	0.429	73.71
115	2.31	12.013	150	1.802	0.506	78.07
115	2.99	12.012	200	2.402	0.590	80.29
115	4.35	12.011	300	3.603	0.748	82.82
115	7.08	12.008	500	6.004	1.074	84.83
115	10.49	12.004	750	9.003	1.486	85.83
115	13.91	12.000	1000	12.000	1.914	86.24
115	20.78	11.992	1500	17.988	2.789	86.58
115	27.65	11.984	2000	23.968	3.680	86.69
115	34.61	11.977	2500	29.943	4.668	86.51
115	41.61	11.969	3000	35.907	5.701	86.30
115	55.86	11.954	4000	47.816	8.044	85.60
115	67.60	11.942	4800	57.322	10.278	84.80
115	90.13	11.920	6260	74.619	15.511	82.79
115	0.07	0.000	6270	0.000	0.070	0.00

Table 7-4. Load Regulation: V<sub>IN</sub>=178 Vac

V <sub>IN</sub> [Vac]	P <sub>IN</sub> [W]	V <sub>OUT</sub> [V]	I <sub>OUT</sub> [mA]	P <sub>OUT</sub> [W]	P <sub>LOSS</sub> [W]	Efficiency [%]
178	0.09	12.013	0	0.000	0.094	0.00
178	0.11	12.013	1	0.012	0.099	10.82
178	0.13	12.013	2	0.024	0.107	18.34
178	0.19	12.012	5	0.060	0.127	32.12
178	0.28	12.012	10	0.120	0.160	42.90
178	0.45	12.012	20	0.240	0.214	52.92
178	0.62	12.012	30	0.360	0.263	57.84
178	0.94	12.012	50	0.601	0.340	63.83
178	1.25	12.011	70	0.841	0.407	67.37
178	1.71	12.011	100	1.201	0.509	70.24
178	2.40	12.013	150	1.802	0.601	74.99
178	3.09	12.012	200	2.402	0.683	77.87
178	4.45	12.011	300	3.603	0.848	80.95
178	7.17	12.008	500	6.004	1.169	83.70
178	10.59	12.004	750	9.003	1.582	85.05
178	13.95	12.000	1000	12.000	1.952	86.01
178	20.71	11.992	1500	17.988	2.723	86.85
178	27.68	11.985	2000	23.970	3.708	86.60
178	34.49	11.977	2500	29.943	4.546	86.82
178	41.15	11.970	3000	35.910	5.244	87.26
178	55.15	11.954	4000	47.816	7.329	86.71
178	66.32	11.942	4800	57.322	8.998	86.43
178	98.43	11.910	7040	83.846	14.584	85.18
178	0.14	0.000	7050	0.000	0.143	0.00

Performance Data – Continued

Table 7-5. Load Regulation:  $V_{IN}=230$  Vac

$V_{IN}$ [Vac]	$P_{IN}$ [W]	$V_{OUT}$ [V]	$I_{OUT}$ [mA]	$P_{OUT}$ [W]	$P_{LOSS}$ [W]	Efficiency [%]
230	0.13	12.011	0	0.000	0.125	0.00
230	0.15	12.011	1	0.012	0.133	8.28
230	0.16	12.011	2	0.024	0.139	14.74
230	0.22	12.011	5	0.060	0.162	27.05
230	0.31	12.011	10	0.120	0.194	38.25
230	0.49	12.011	20	0.240	0.249	49.12
230	0.66	12.011	30	0.360	0.298	54.76
230	0.98	12.011	50	0.601	0.380	61.22
230	1.29	12.010	70	0.841	0.450	65.12
230	1.75	12.010	100	1.201	0.552	68.51
230	2.51	12.009	150	1.801	0.712	71.68
230	3.21	12.008	200	2.402	0.806	74.86
230	4.60	12.007	300	3.602	0.999	78.29
230	7.34	12.004	500	6.002	1.338	81.77
230	10.76	12.001	750	9.001	1.759	83.65
230	14.23	11.997	1000	11.997	2.233	84.31
230	21.11	11.989	1500	17.984	3.127	85.19
230	27.85	11.981	2000	23.962	3.888	86.04
230	34.66	11.974	2500	29.935	4.725	86.37
230	41.66	11.967	3000	35.901	5.759	86.18
230	55.40	11.952	4000	47.808	7.592	86.30
230	66.40	11.941	4800	57.317	9.083	86.32
230	98.81	11.909	7100	84.554	14.256	85.57
230	0.20	0.000	7200	0.000	0.200	0.00

Table 7-6. Load Regulation:  $V_{IN}=264$  Vac

$V_{IN}$ [Vac]	$P_{IN}$ [W]	$V_{OUT}$ [V]	$I_{OUT}$ [mA]	$P_{OUT}$ [W]	$P_{LOSS}$ [W]	Efficiency [%]
264	0.16	12.012	0	0.000	0.161	0.00
264	0.17	12.012	1	0.012	0.162	6.90
264	0.19	12.012	2	0.024	0.167	12.58
264	0.25	12.012	5	0.060	0.187	24.32
264	0.34	12.012	10	0.120	0.218	35.54
264	0.52	12.012	20	0.240	0.278	46.38
264	0.68	12.012	30	0.360	0.323	52.76
264	1.01	12.012	50	0.601	0.408	59.52
264	1.33	12.011	70	0.841	0.484	63.45
264	1.78	12.011	100	1.201	0.579	67.48
264	2.56	12.012	150	1.802	0.762	70.27
264	3.28	12.012	200	2.402	0.874	73.33
264	4.67	12.010	300	3.603	1.068	77.14
264	7.42	12.007	500	6.004	1.417	80.91
264	10.84	12.003	750	9.002	1.838	83.05
264	14.28	11.999	1000	11.999	2.281	84.03
264	21.05	11.991	1500	17.987	3.064	85.45
264	27.98	11.983	2000	23.966	4.014	85.65
264	34.75	11.976	2500	29.940	4.810	86.16
264	41.61	11.968	3000	35.904	5.706	86.29
264	55.27	11.952	4000	47.808	7.462	86.50
264	66.37	11.940	4800	57.312	9.058	86.35
264	100.31	11.901	7210	85.806	14.504	85.54
264	0.25	0.000	7220	0.000	0.248	0.00

Line Regulation

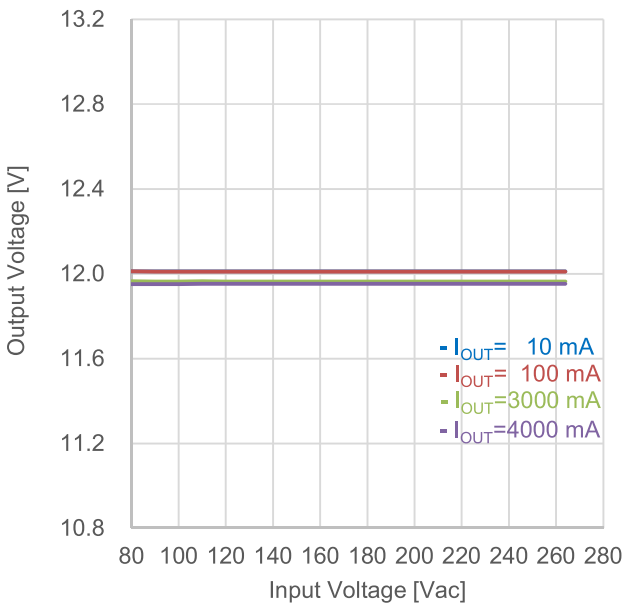

Figure 26. Line Regulation ( $V_{IN}$  vs  $V_{OUT}$ )

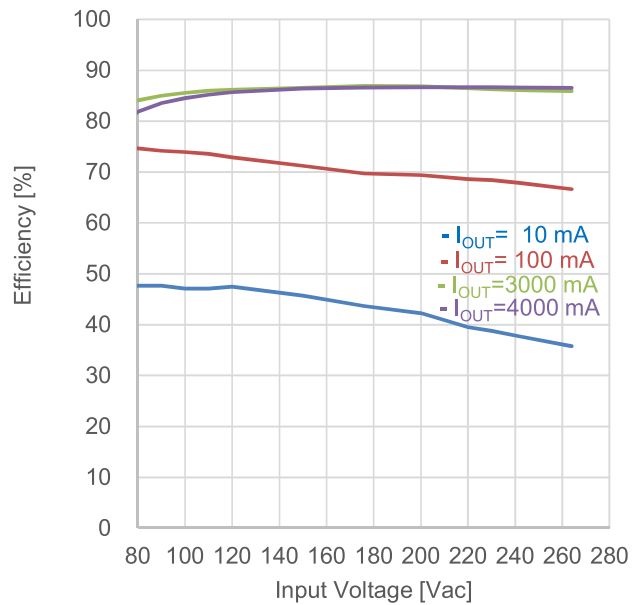

Figure 27. Line Regulation ( $V_{IN}$  vs Efficiency)

Performance Data – Continued

Switching Frequency

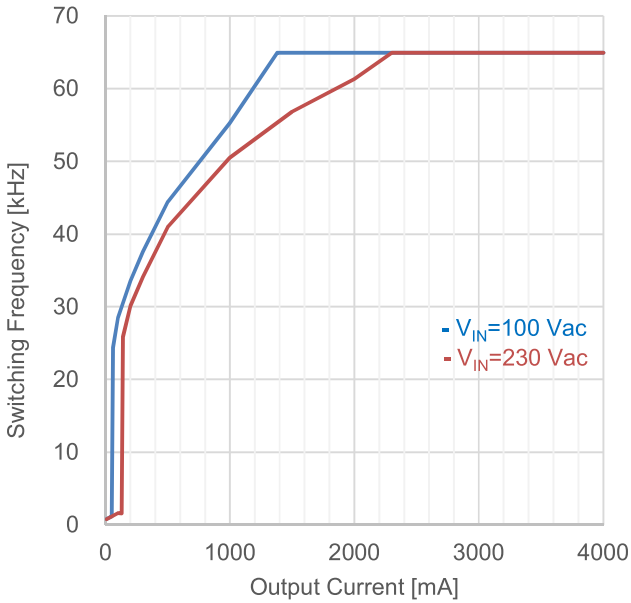

Figure 28. Switching Frequency ( $I_{OUT}$  vs  $f_{sw}$ )

Transfer Peak Current

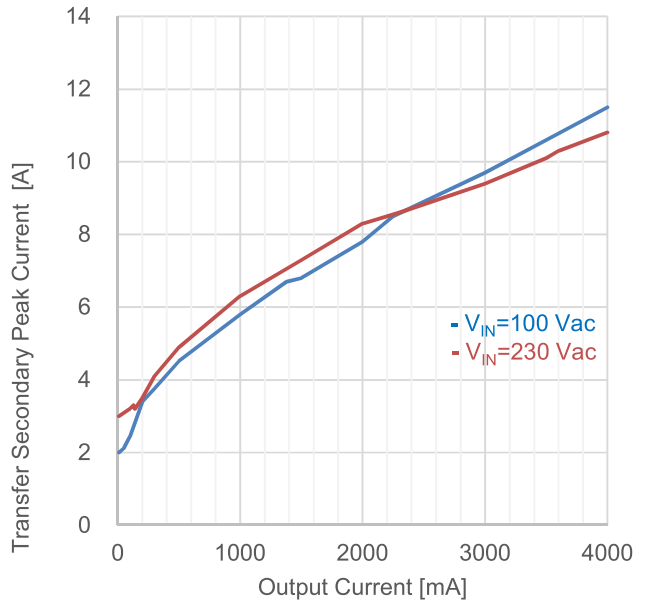
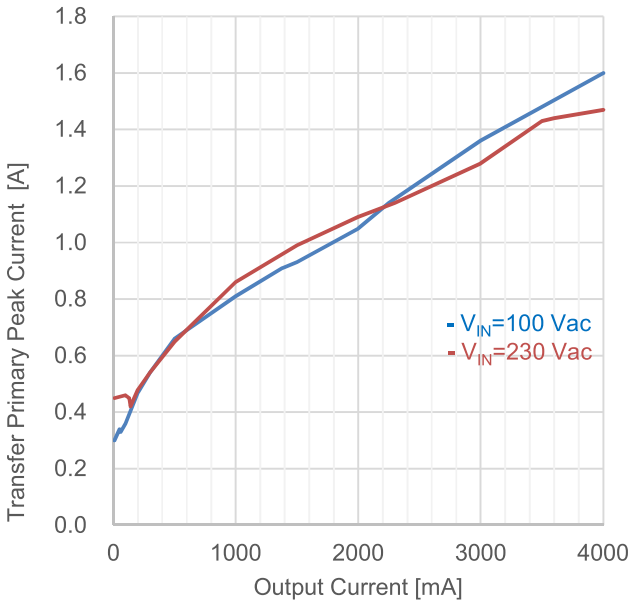

Figure 29. Transfer Primary Peak Current ( $I_{OUT}$  vs  $I_{PPK}$ )    Figure 30. Transfer Secondary Peak Current ( $I_{OUT}$  vs  $I_{SPK}$ )

Performance Data – Continued

Operation Waveform

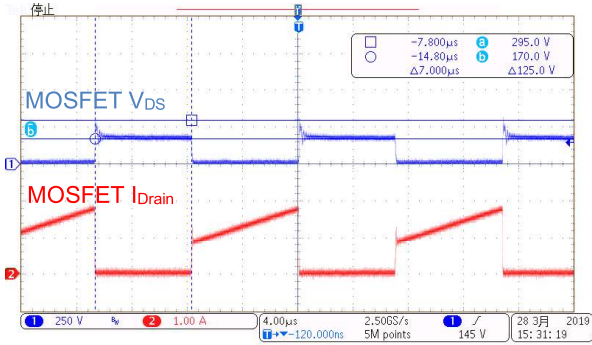

Figure 31. MOSFET  $V_{IN} = 90 \text{ Vac}$ ,  $I_{OUT} = 4.0 \text{ A}$

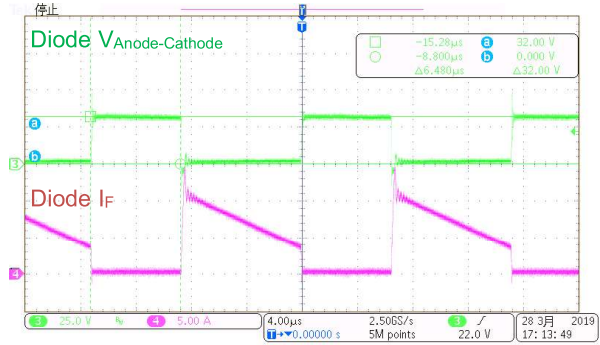

Figure 32. Diode  $V_{IN} = 90 \text{ Vac}$ ,  $I_{OUT} = 4.0 \text{ A}$

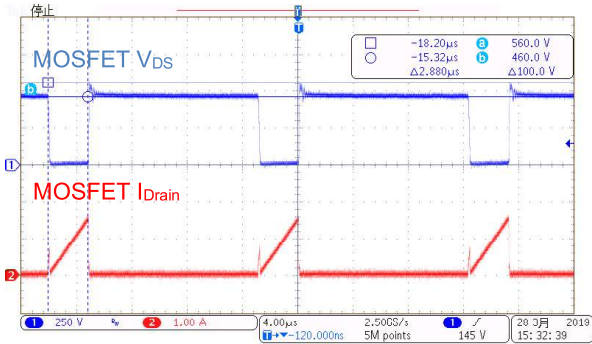

Figure 33. MOSFET  $V_{IN} = 264 \text{ Vac}$ ,  $I_{OUT} = 4.0 \text{ A}$

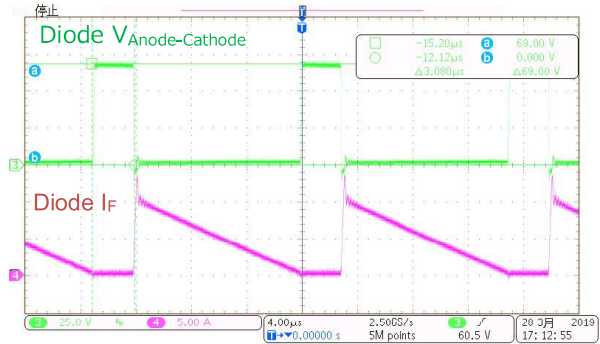

Figure 34. Diode  $V_{IN} = 264 \text{ Vac}$ ,  $I_{OUT} = 4.0 \text{ A}$

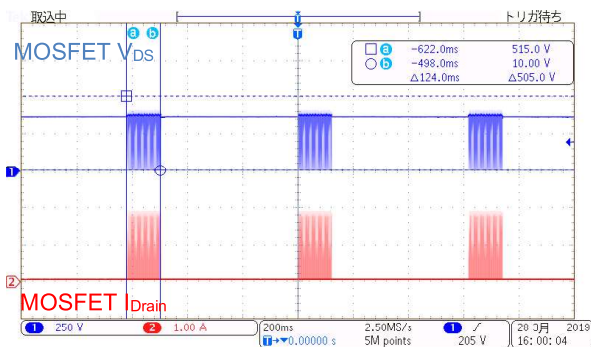

Figure 35. MOSFET  $V_{IN} = 264 \text{ Vac}$ , Output Short

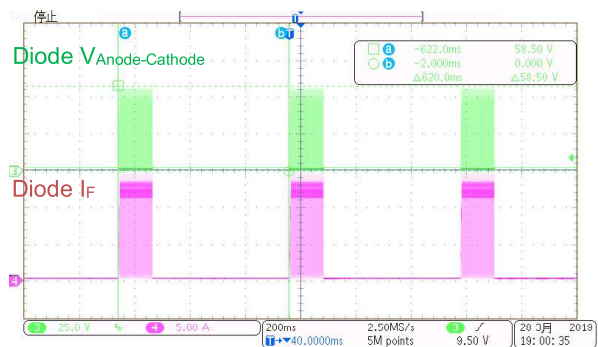

Figure 36. Diode  $V_{IN} = 264 \text{ Vac}$ , Output Short

Performance Data – Continued

Power On

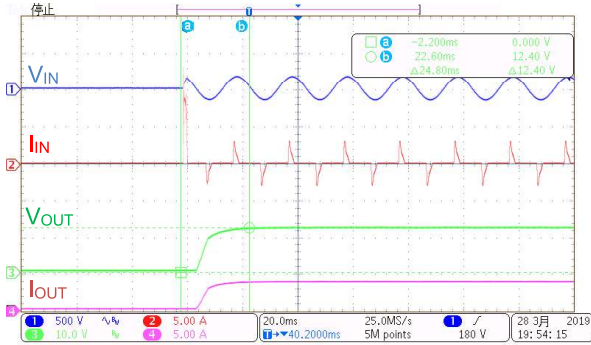

Figure 37.  $V_{IN} = 115 \text{ Vac}$ ,  $I_{OUT} = 4.0 \text{ A}$

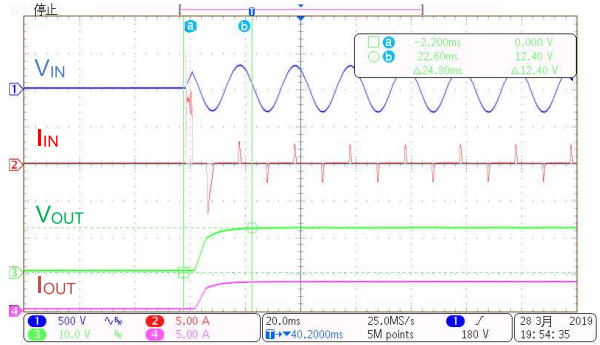

Figure 38.  $V_{IN} = 230 \text{ Vac}$ ,  $I_{OUT} = 4.0 \text{ A}$

Dynamic Response

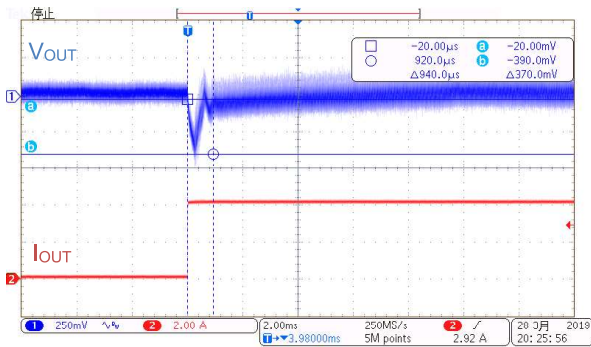

Figure 39.  $V_{IN} = 115 \text{ Vac}$ ,  $I_{OUT} = 10 \text{ mA} \rightarrow 4.0 \text{ A}$

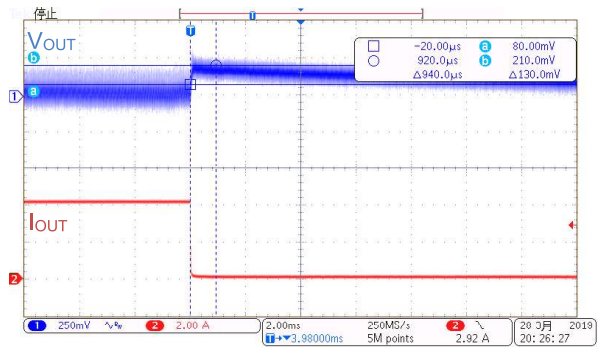

Figure 40.  $V_{IN} = 230 \text{ Vac}$ ,  $I_{OUT} = 4.0 \text{ A} \rightarrow 10 \text{ mA}$

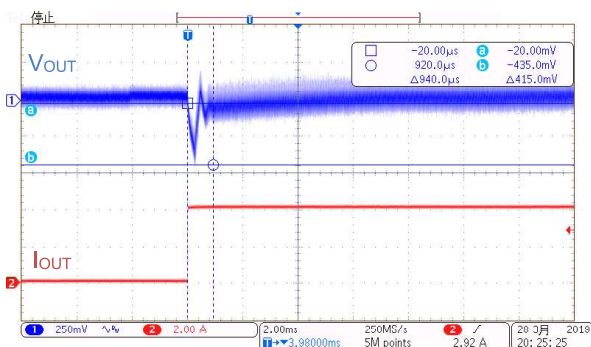

Figure 41.  $V_{IN} = 115 \text{ Vac}$ ,  $I_{OUT} = 10 \text{ mA} \rightarrow 4.0 \text{ A}$

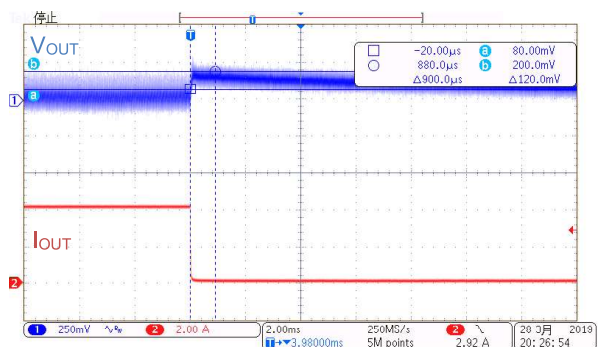

Figure 42.  $V_{IN} = 230 \text{ Vac}$ ,  $I_{OUT} = 4.0 \text{ A} \rightarrow 10 \text{ mA}$



Performance Data – Continued

Output Ripple Voltage

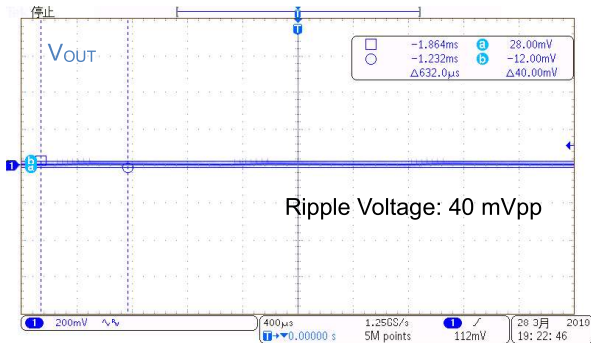

Figure 43.  $V_{IN} = 115 \text{ Vdc}$ ,  $I_{OUT} = 10 \text{ mA}$

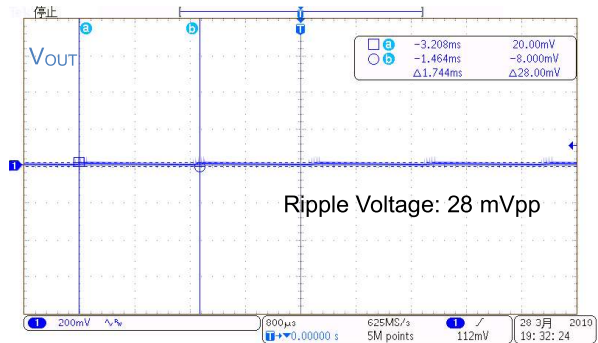

Figure 44.  $V_{IN} = 230 \text{ Vac}$ ,  $I_{OUT} = 10 \text{ mA}$

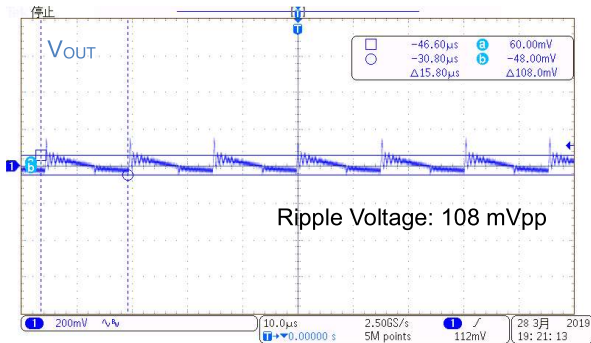

Figure 45.  $V_{IN} = 115 \text{ Vac}$ ,  $I_{OUT} = 3.0 \text{ A}$

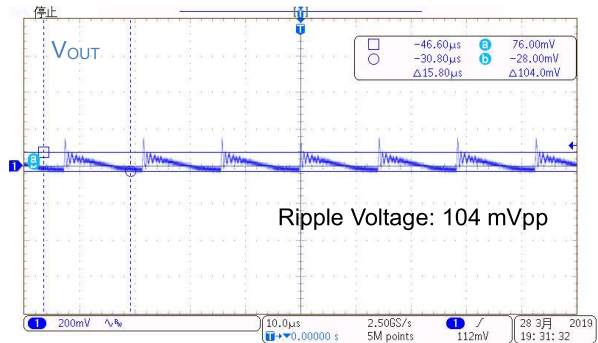

Figure 46.  $V_{IN} = 230 \text{ Vac}$ ,  $I_{OUT} = 3.0 \text{ A}$

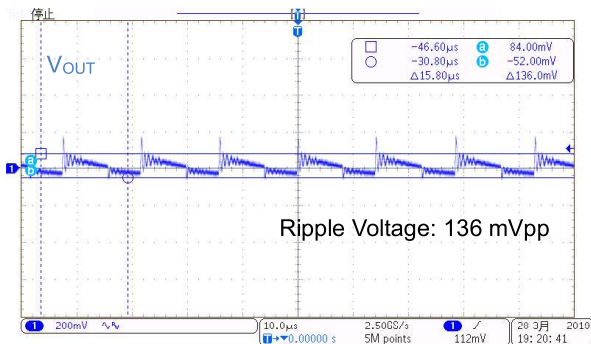

Figure 47.  $V_{IN} = 115 \text{ Vac}$ ,  $I_{OUT} = 4.0 \text{ A}$

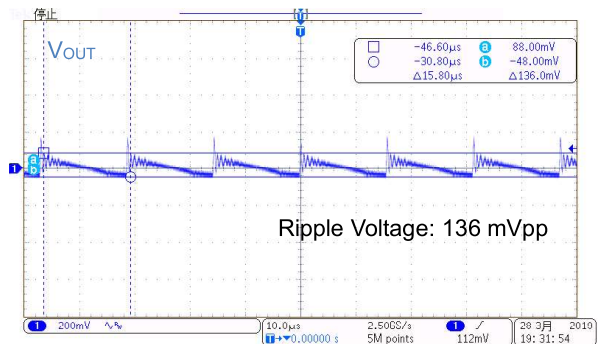

Figure 48.  $V_{IN} = 230 \text{ Vac}$ ,  $I_{OUT} = 4.0 \text{ A}$

Performance Data – Continued

Parts surface temperature

Table 8. Parts surface temperature

Ta = 25 °C, measured 30 minutes after startup

Part	Condition			
	V <sub>IN</sub> =90 Vac, I <sub>OUT</sub> =3 A	V <sub>IN</sub> =90 Vac, I <sub>OUT</sub> =4 A	V <sub>IN</sub> =264 Vac, I <sub>OUT</sub> =3 A	V <sub>IN</sub> =264 Vac, I <sub>OUT</sub> =4 A
LF1	52.7 °C	76.9 °C	40.9 °C	46.7 °C
DB1	59.8 °C	73.9 °C	48.6 °C	51.9 °C
IC1	56.7 °C	70.8 °C	53.2 °C	63.2 °C
T1	64.2 °C	64.2 °C	64.7 °C	74.3 °C
R8	72.3 °C	83.0 °C	74.9 °C	80.6 °C
D4	70.9 °C	88.9 °C	72.6 °C	83.7 °C

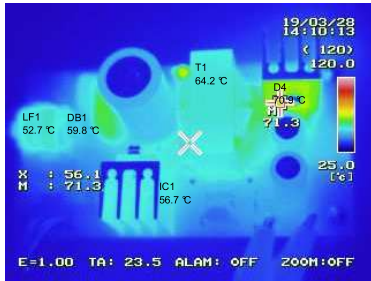

Figure 49. Thermal Image  
VIN: 90 Vac, IOUT: 4 A

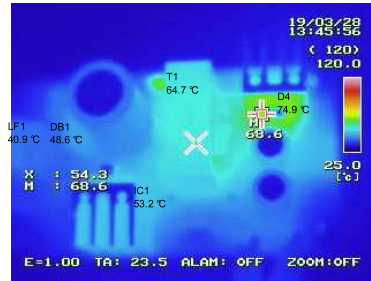
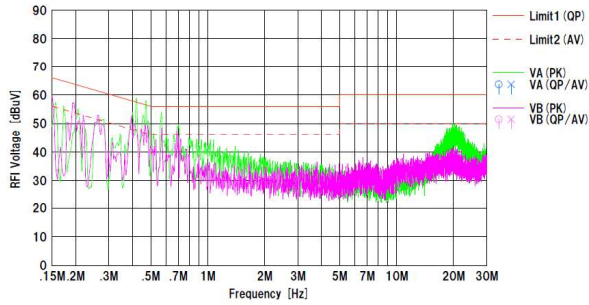

Figure 50. Thermal Image  
VIN: 264 Vac, IOUT: 4 A

Performance Data – Continued

EMI

• Conducted Emission



QP margine : 10.4 dB  
 AVE margine : 12.2 dB

Figure 51.  $V_{IN}$ : 110 Vac / 60 Hz,  $I_{OUT}$ : 4 A

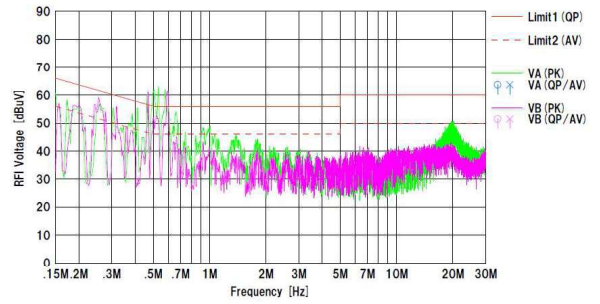

QP margine : 3.2 dB  
 AVE margine : 4.4 dB

Figure 52.  $V_{IN}$ : 230 Vac / 50 Hz,  $I_{OUT}$ : 4 A

• Radiated Emission

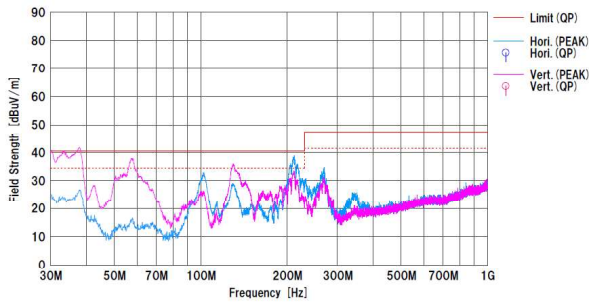

QP margine : 3.7 dB

Figure 53.  $V_{IN}$ : 110 Vac / 60 Hz,  $I_{OUT}$ : 4 A

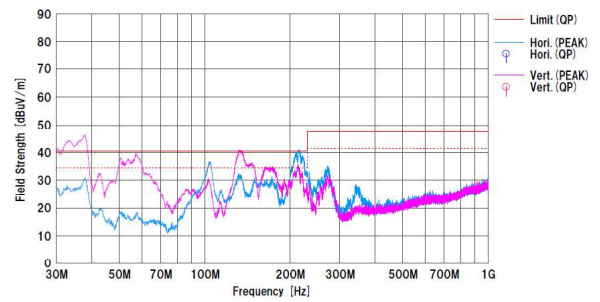

QP margine : 5.5 dB

Figure 54.  $V_{IN}$ : 230 Vac / 50 Hz,  $I_{OUT}$ : 4 A

Schematics

$V_{IN} = 90 \sim 264 \text{ Vdc}$ ,  $V_{OUT} = 12 \text{ V}$

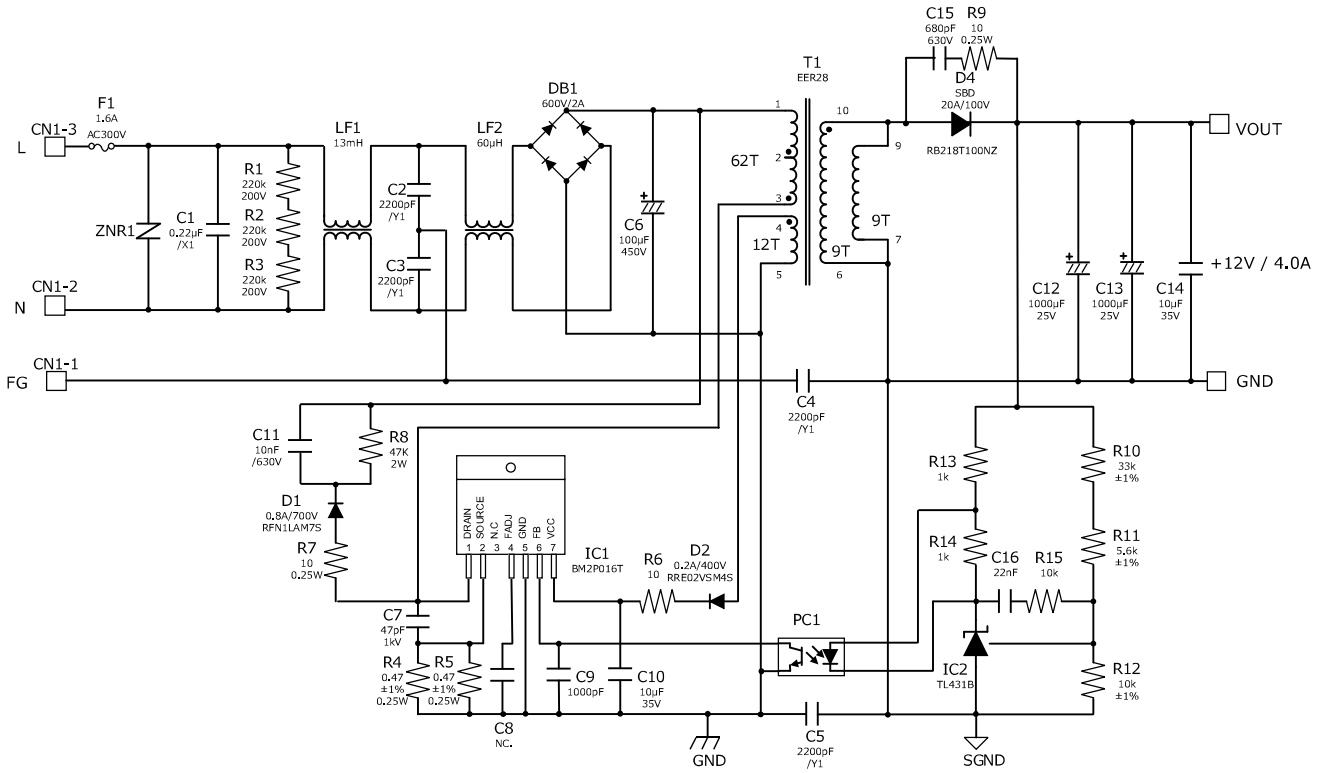

Figure 55. BM2P016T-EVK-003 Schematics

## Bill of Materials

Table 9. BoM of BM2P016T-EVK-003

Part Reference	Qty.	Type	Value	Description	Part Number	Manufacture	Configuration mm (inch)
C1	1	X2 Capacitor	0.22 $\mu$ F	300Vac, $\pm$ 20%	890 334 025 027 CS	Wurth	-
C2,C3,C4, C5	4	Y1 Capacitor	2200pF	Y1 capacitor	DE1E3RA222MJ4BP01F	Murata	-
C6	1	Electrolytic	100 $\mu$ F	450V, $\pm$ 20%	450BXW100MEFR18X30	Rubycon	18mm $\Phi$ X30mm
C7	1	Ceramic	47pF	1kV, X7R, $\pm$ 10%	RDE5C3A470J2K1H03B	Murata	-
C8	0	-	-	25V, $\pm$ 20%	-	-	-
C9	1	Ceramic	1000pF	100V, X7R, $\pm$ 20%	HMK107B7102MA-T	Taiyo Yuden	1608 (0603)
C10,C14	2	Ceramic	10 $\mu$ F	35V, X7R, $\pm$ 20%	GMK316AB7106ML-TR	Taiyo Yuden	3216 (1206)
C11	1	Ceramic	10nF	630V, X7R, $\pm$ 10%	SMK316B7103KF-T	Taiyo Yuden	3216 (1206)
C12,C13	2	Electrolytic	1000 $\mu$ F	25V, $\pm$ 20%	25ZLJ1000M10X20	Rubycon	10mm $\Phi$ X20mm
C15	1	Ceramic	680pF	630V, C0G, $\pm$ 10%	GRM31B5C2J681FW01L	Murata	3216 (1206)
C16	1	Ceramic	22nF	100V, X7R, $\pm$ 10%	HMK107B7223KA-T	Taiyo Yuden	1608 (0603)
CN1	1	Connector	3pin	-	B3P-NV	JST	-
CN2	1	Connector	2pin	-	B2P-VH	JST	-
D1	1	FRD	0.8A	700V	RFN1LAM7S	ROHM	PMDTM
D2	1	RD	0.2A	400V	RRE02VSM4S	ROHM	TUMD2SM
D3	1	SBD	20A	100V	RB218T100NZ	ROHM	TO-220
D4	0	-	-	-	-	-	-
DB1	1	Bridge Diode	2A	600V	D2SBA60	Shindengen	SIP4
F1	1	Fuse	1.6A	300V	36911600000	Littelfuse	-
HS1,HS2	2	Heat Sink	-	22.9 $^{\circ}$ C/W	IC-1625-STL	Sankyo Thermotec	-
-	2	Skrew	M3	M3	-	-	-
IC1	1	AC/DC Converter	-	650V	BM2P016T-Z	ROHM	TO-220-7
IC2	1	Shunt Regulator	-	-	TL431BIDBZT	TI	SOT-23-3
LF1	1	Line Filter	13mH	1A	XF1482Y	Alpha Trans	-
LF2	1	Line Filter	60 $\mu$ H	1A	LF1246Y	Alpha Trans	-
PC1	1	Optocoupler	-	5kV	LTV-817-B	LiteOn	DIP4
R1,R2,R3	3	Resistor	220k $\Omega$	0.25W, $\pm$ 5%	MCR18E2PJ224	ROHM	3216 (1206)
R4,R5	2	Resistor	0.47 $\Omega$	0.25W, $\pm$ 1%	MCR18EZHFLR470	ROHM	3216 (1206)
R6	1	Resistor	10 $\Omega$	0.25W, $\pm$ 5%	MCR18E2PJ100	ROHM	3216 (1206)
R7,R9	2	Resistor	10 $\Omega$	0.25W, $\pm$ 5%	MCR18E2PJ100	ROHM	3216 (1206)
R8	1	Resistor	47k $\Omega$	2W, $\pm$ 2%	ERG2S1473	Panasonic	-
R10	1	Resistor	33k $\Omega$	0.1W, $\pm$ 1%	MCR03E2PFX3302	ROHM	1608 (0603)
R11	1	Resistor	5.6k $\Omega$	0.1W, $\pm$ 1%	MCR03E2PFX5601	ROHM	1608 (0603)
R12,R15	2	Resistor	10k $\Omega$	0.1W, $\pm$ 1%	MCR03E2PFX1002	ROHM	1608 (0603)
R13,R14	2	Resistor	1k $\Omega$	0.1W, $\pm$ 5%	MCR03E2PJ102	ROHM	1608 (0603)
T1	1	Transformer	-	Bobin:EER2828-10pin Core:EER28/28	XE2236Y_B	Alpha Trans	-
ZNR1	1	Varistor	-	300Vac, 423Vmin, 400A	V470ZA05P	Littelfuse	-

PCB

Size : 55 mm x 105 mm

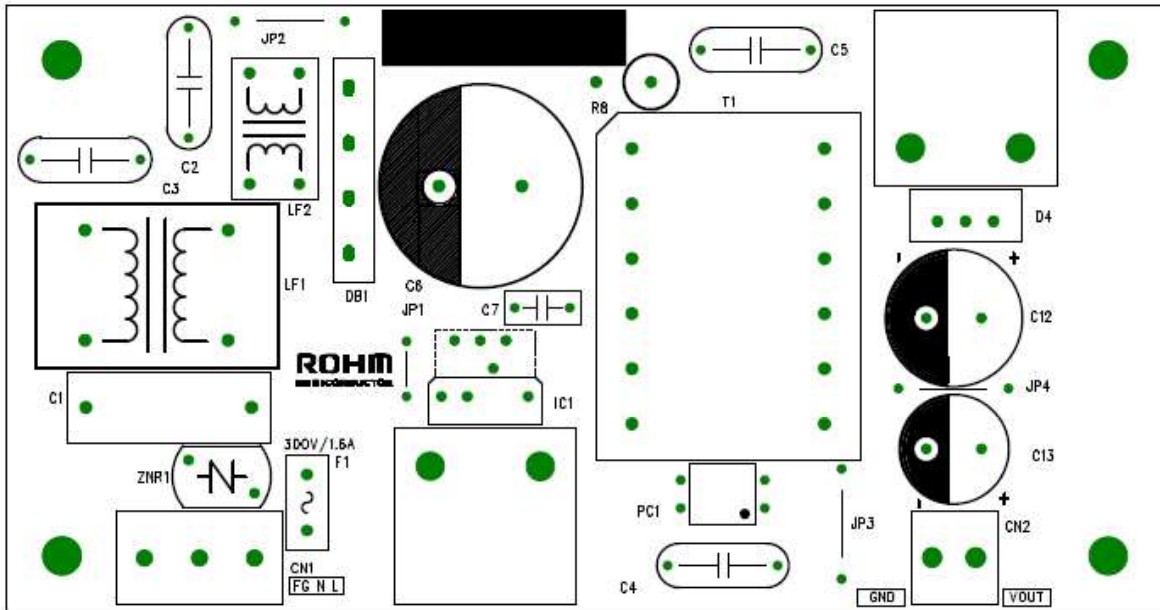

Figure 56. Top Layout (Top view)

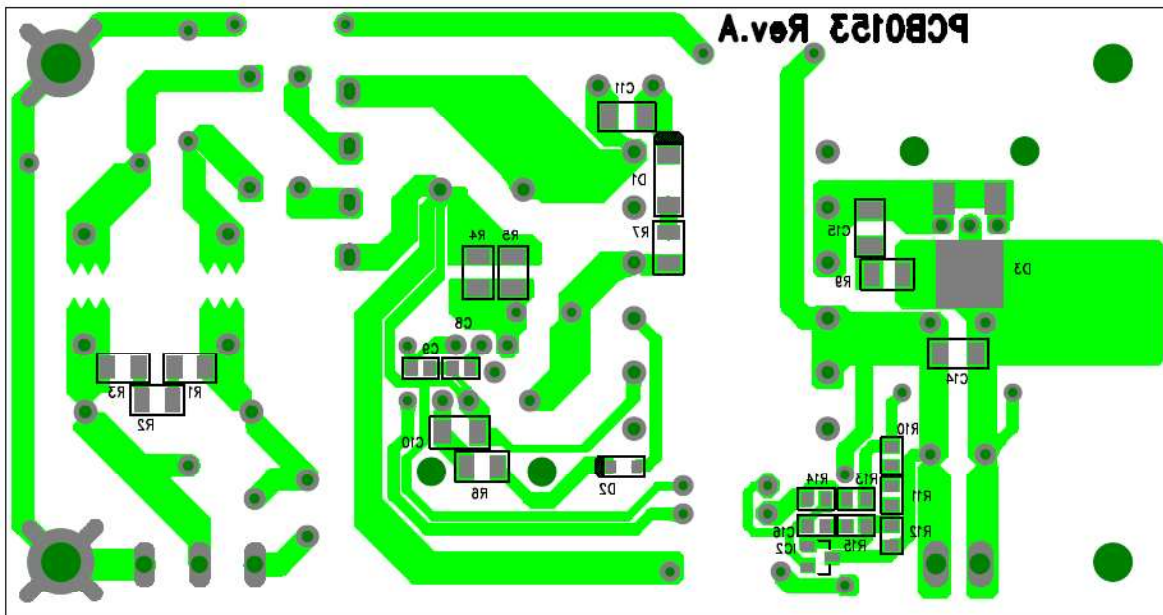

Figure 57. Bottom Layout (Top view)

## Notes

- 1) The information contained herein is subject to change without notice.
- 2) Before you use our Products, please contact our sales representative and verify the latest specifications :
- 3) Although ROHM is continuously working to improve product reliability and quality, semiconductors can break down and malfunction due to various factors.  
Therefore, in order to prevent personal injury or fire arising from failure, please take safety measures such as complying with the derating characteristics, implementing redundant and fire prevention designs, and utilizing backups and fail-safe procedures. ROHM shall have no responsibility for any damages arising out of the use of our Products beyond the rating specified by ROHM.
- 4) Examples of application circuits, circuit constants and any other information contained herein are provided only to illustrate the standard usage and operations of the Products. The peripheral conditions must be taken into account when designing circuits for mass production.
- 5) The technical information specified herein is intended only to show the typical functions of and examples of application circuits for the Products. ROHM does not grant you, explicitly or implicitly, any license to use or exercise intellectual property or other rights held by ROHM or any other parties. ROHM shall have no responsibility whatsoever for any dispute arising out of the use of such technical information.
- 6) The Products specified in this document are not designed to be radiation tolerant.
- 7) For use of our Products in applications requiring a high degree of reliability (as exemplified below), please contact and consult with a ROHM representative : transportation equipment (i.e. cars, ships, trains), primary communication equipment, traffic lights, fire/crime prevention, safety equipment, medical systems, servers, solar cells, and power transmission systems.
- 8) Do not use our Products in applications requiring extremely high reliability, such as aerospace equipment, nuclear power control systems, and submarine repeaters.
- 9) ROHM shall have no responsibility for any damages or injury arising from non-compliance with the recommended usage conditions and specifications contained herein.
- 10) ROHM has used reasonable care to ensure the accuracy of the information contained in this document. However, ROHM does not warrants that such information is error-free, and ROHM shall have no responsibility for any damages arising from any inaccuracy or misprint of such information.
- 11) Please use the Products in accordance with any applicable environmental laws and regulations, such as the RoHS Directive. For more details, including RoHS compatibility, please contact a ROHM sales office. ROHM shall have no responsibility for any damages or losses resulting non-compliance with any applicable laws or regulations.
- 12) When providing our Products and technologies contained in this document to other countries, you must abide by the procedures and provisions stipulated in all applicable export laws and regulations, including without limitation the US Export Administration Regulations and the Foreign Exchange and Foreign Trade Act.
- 13) This document, in part or in whole, may not be reprinted or reproduced without prior consent of ROHM.



Thank you for your accessing to ROHM product informations.  
More detail product informations and catalogs are available, please contact us.

## ROHM Customer Support System

<http://www.rohm.com/contact/>

# Mouser Electronics

Authorized Distributor

Click to View Pricing, Inventory, Delivery & Lifecycle Information:

[ROHM Semiconductor:](#)

[BM2P016T-EVK-003](#)