

RS485 option Relay option
Pod Positions

1

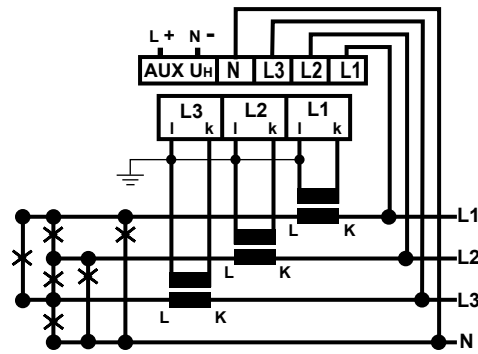

	Voltage				Current		
	L1	L2	L3	N	L1	L2	L3
1ph	✓	✗	✗	✗	✓	✓	✗
1ph 3W	✓	✓	✗	✓	✓	✗	✗
3ph 3W	✓	✓	✗	✗	✓	✗	✓
3ph 4W	✓	✓	✓	✓	✓	✓	✓
3ph 3W BAL	✓	✓	✓	✗	✓	✗	✗
3ph 4W BAL	✓	✗	✗	✓	✓	✗	✗

Unused Voltage terminals are internally connected
Secondary of CT's must be connected to earth

2

Display Screens

Each screen is displayed by pressing its appropriate button, (I for Current, V/Hz for Voltage and Frequency, P for Power and E for Energy). Further presses of a screen's button will scroll through the available measurements associated with that button. Each button's state is stored in memory. N.B. the energy readings are permanently displayed on the LCD's fourth line.

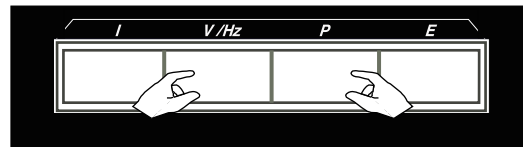

The LED brightness or LCD back-light brightness is adjusted by holding down the two centre buttons. The LCD's back-light colour (blue, white or green) can be changed by holding the 'I' and 'P' buttons down for 6-8 seconds.

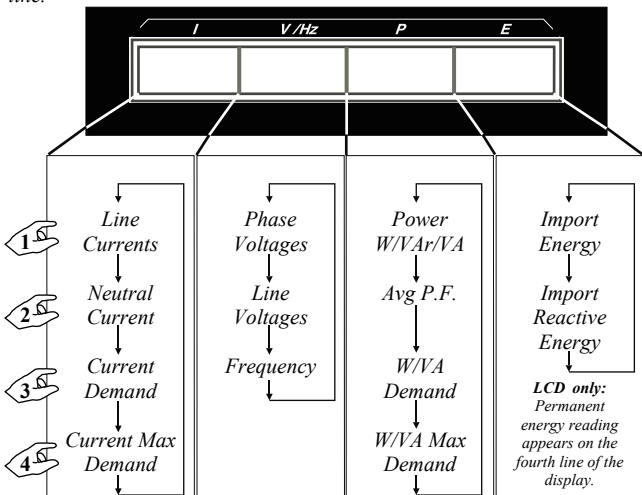

3

Software:
Software can be provided for use with the optional RS485 module. The plug-in module enables the unit to communicate with devices using the popular Modbus protocol.



4

Settings Menu

The main menu is entered by holding buttons 'I' and 'E' down for approximately 5 seconds. The main menu and all sub-menus are scrolled through using the 'E' button. Any selection is made using the 'I' button.

If no buttons are pressed for 6 minutes the unit will exit the Settings Menu.

The Settings Menu structure is defined below:

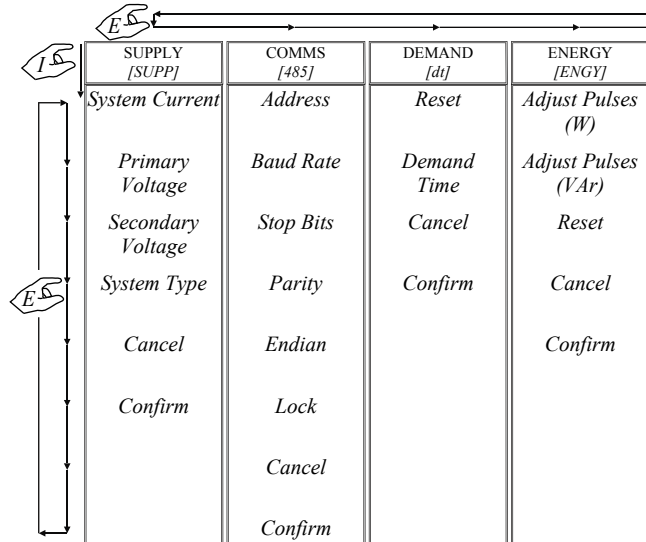

5

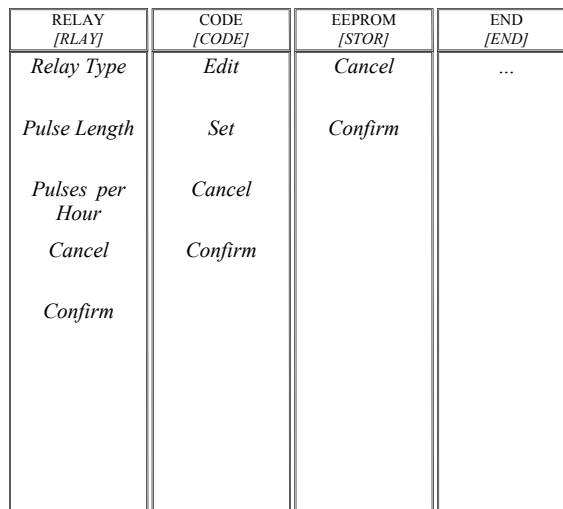

6

Supply [SUPP]
SYSTEM CURRENT [SYSA]
PRIMARY VOLTAGE [UPRI]
SECONDARY VOLTAGE [USEC]
SYSTEM TYPE [TYPE]

The VT ratio and the system current are entered using this sub-menu. The secondary voltage (meter input) is optimised at 280V L-N. Decimal point positioning and exponent selection is used in this section

- Un-Balanced
- [1P2] 1 phase 2 wire
- [3P3] 3 phase 3 wire
- [3P4] 3 phase 4 wire
- [1P3] 1 phase 3 wire
- Balanced
- [3P3B] 3 phase 3 wire
- [3P4B] 3 phase 4 wire

The system's type is selected from the list on the right:

Comms [485]
ADDRESS [ADDR]

(RS485 option) Network settings can be detected and the unit configured automatically. If manual configuration is preferred, the meter can be set up as follows:

BAUD RATE [BAUD]

The unit's baud rate, number of stop bits and parity can be selected from the lists on the right:

- [4.8] 4800 baud
- [9.6] 9600 baud
- [19.2] 19200 baud
- [38.4] 38400 baud
- [57.6] 57600 baud

STOP BITS [STOP]

Floating point numbers can be transmitted in Big Endian or Little Endian BYTE order and can be selected using the ENDIAN item. (word-swap option selectable for both)

- [0] no stop bits
- [1] 1 stop bit
- [2] 2 stop bits

PARITY [PAR]

Locking prevents the unit hunting for a valid network if communication errors are occurring and can be set using the LOCK item.

- [M] no parity bit
- [O] odd parity bit
- [E] even parity bit

ENDIAN [ENDI]

LOCK [LOC]

7

Demand [dt]

The unit integrates all measurements of Amps, Power and VA within a variable time length, sliding window.

RESET [RSET]

The reset option will reset all demand and maximum demand measurements.

DEMAND TIME [DTST]

The demand time (window) can be set to a value of between 3 and 60 minutes inclusive.

Energy [ENGY]

There are two energy accumulators in the unit; Import Power and Import VAr. Modifications to the pulses per hour rate can be done through this sub-menu.

ADJUST PULSES [ADJ] (W)

Adjust pulses (W or VAr) allows the selection of a DIVISOR from the list on the right:

- 1000
- 100
- 10
- 1
- 0.1
- 0.01
- 0.001

ADJUST PULSES [ADJ] (VAr)

Caution: Changing the divisor and confirming the selection will reset ALL energy readings

RESET [RSET]

The reset option resets ALL energy readings.

Relay [RLAY]

The relay(s) (optional) can operate as W.h or VAr.h types. The principle relay can be set up in this sub-menu. If two relays are installed the secondary relay is automatically set as the alternative type.

RELAY TYPE [TYPE]

- OFF
- 40
- 60
- 80
- 100
- 120
- 140
- 160
- 180
- 200

PULSE LENGTH [PULS LNTH]

The pulse length of the relay(s) can be set from the list on the right (0-200ms). PPH are modified using the decimal point positioning method.

PULSES per HOUR [PPH]

9

Code [CODE]

The Pass Code is used to help prevent unauthorised tampering with the unit's settings.

EDIT PASS CODE [EDIT]

The Pass Code can be changed using the EDIT facility in the sub-menu.

SET PASS CODE [SET]

It is activated using the SET option.

EEPROM [STOR]

The EEPROM sub-menu allows the user to save all settings into the unit's non-volatile memory. It is recommended that this option is used whenever settings have been updated. However, the unit will save all settings on a power down or brown out condition.

END [END]

This selection leaves the main menu and resumes displaying measurements.

CANCEL [CNCL]

At the end of most sub-menus is the option to cancel any changes made in that sub-menu.

CONFIRM [CONF]

Confirmation is required before any changes are implemented. The changes are effective as soon as they are confirmed.

11

Entering Data

When required, numbers can be entered into the unit in the following way:

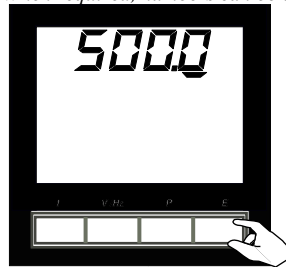

To increment a column - press 'E'

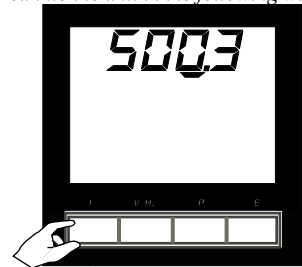

To confirm or move - press 'E'

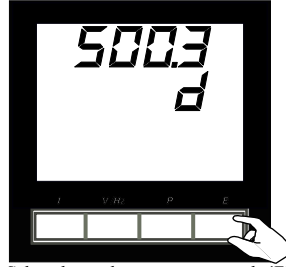

Select decimal point position with 'E'

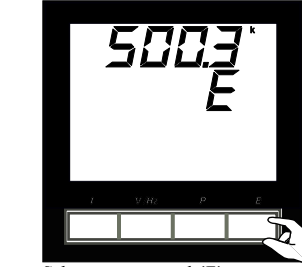

Select exponent with 'E'

8

Lists

When only fixed data can be entered, selection is made from a list:

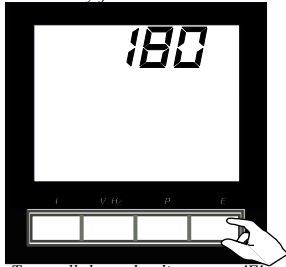

To scroll through a list - press 'E'

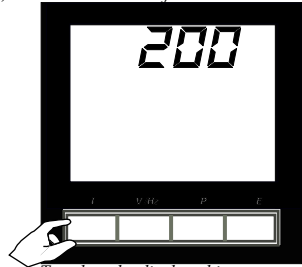

To select the displayed item - press 'E'

When a decision has to be made the Yes - No screen is displayed

Entering Data - Summary

Pressing the 'I' button accepts the currently selected item and moves on to the next. Pressing the 'E' button either changes the item's option or increments a column. Other menu items that may be displayed are all treated in the same manner.

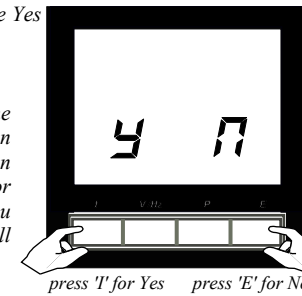

press 'I' for Yes press 'E' for No

10

Input (accuracy range)

Un 28V to 330V L-N (48V to 570V L-L)

Burden < 0.5VA

In (5A specified) 0.5A to 6A via CT

In (1A specified) 0.1A to 1.2A via CT

Burden < 0.5VA

Frequency 45Hz to 65Hz

Secondary of CTs must be connected to earth

Input (working range)

Voltage and Current 1.7% - 100%

Overload

800V L-L indefinitely, In x 10 for 1 sec

Accuracy (8.4% - 100% of range)

Voltage 0.5% +/- 2 digits

Current 0.5% +/- 2 digits

Power (W, VAr, VA) 1.0% +/- 2 digits

Power Factor 1% of range

Frequency 0.1 Hz

Energy IEC 1036 Class I

Auxiliary Voltage

100V to 440V ac (45Hz to 65Hz)

100V to 420V dc

Burden: < 10VA

Display

Digits (LED/LCD) 3 lines 9999

Digit size 14.2mm 7 segment

Energy (LCD) 1 line 99999999

Digit size 6mm 7 segment

Update time 1 second

Options

Plug-in RS485 module (Modbus)

Plug-in relay module (W.h VAr.h)

19V-69V d.c. Auxiliary

Insulation

Installation Category III (480V ph/ph)

Degree of Pollution 2

Rated Impulse Voltage IEC 60947-1-V

imp 4kV

Meter Front Class II

Electrical Security IEC 61010-1

Electromagnetic Compatibility

Immunity:

ESD IEC 61000-4-2-Level III

Radiated IEC 61000-4-3-Level III

Fast Transient IEC 61000-4-4-Level III

Impulse Waves IEC 61000-4-5-Level III

Conducted IEC 61000-4-6-Level III

Voltage Dips/ Short Interruptions IEC 61000-4-11-Level II

Emissions:

Conducted and Radiated CISPR11-Class A

Environment

Working Temperature (LED) -10 to 60 deg C

Working Temperature (LCD) -20 to 70 deg C

Storage Temperature -30 to 80 deg C

Relative Humidity 0-95% non condensing

Shock 30G in 2 planes

Enclosure

Standard DIN case 96 x 96 x 60mm

Panel mounting 4 retaining clips

Cutout 92.8mm x 92.8mm

IP Rating - Front IP52 / Nema

IP Rating - Case IP30 / Nema

12