

RX66T CPU Card

R12UZ0029EJ0110

Rev.1.10

User's Manual

Feb. 21, 2019

For Your Safety



Do not fail to read this manual before using the RX66T CPU card (RTK0EMX870C00000BJ) (the product).

- Follow the indications in this manual when using the product.
- This product is the option board of "24V Motor Control Evaluation System for RX23T (RTK0EM0006S01212BJ)". Please read "Warnings Regarding Use of the Product" of the 24V Motor Control Evaluation System for RX23T User's Manual, and use this product.
- Keep this manual near the product so you can refer to it whenever necessary.
- Transfer or sale of the product to third parties is prohibited without written approval.
- The purchaser or importer of the product is responsible for ensuring compliance with local regulations. In addition, the customer is responsible for ensuring that the product is handled correctly and safely, in accordance with the laws of the customer's country (region).
- All information contained in this manual represents information on products at the time of publication of this manual. Please note that the product data, specification, sales offices, contents of website, address, etc., are subject to change by Renesas Electronics Corporation without notice due to product improvements or other reasons. Please confirm the latest information on Renesas Electronics website.
- The manual for the product, and specification (the documents) are the tool that was developed for the function and performance evaluation of Renesas Electronics semiconductor device (Renesas Electronics device) mounted on the product, and not guarantee the same quality, function and performance.
- By purchasing the product or downloading the documents from Renesas Electronics website, the support services provided from Renesas Electronics is not guaranteed.

Meaning of Notations

In this manual items related to the safe use of the product are indicated as described below.

The degree of injury to persons or damage to property that could result if the designated content in this manual is not followed is indicated as follows.

 Danger	Indicates content that, if not followed, could result in death or serious injury* ¹ to the user, and which is highly urgent.
 Warning	Indicates content that, if not followed, could result in death or serious injury to the user.
 Caution	Indicates content that, if not followed, could result in injury* ² to persons or physical damage.* ³

Note 1. Serious injury refers to conditions resulting in persistent after-effects and for which treatment would necessitate hospitalization or regular hospital visits, such as loss or impairment of eyesight, burns (high- or low-temperature), electric shock, bone fracture, or poisoning.

Note 2. Injury refers to conditions for which treatment would necessitate hospitalization or regular hospital visits.

Note 3. Physical damage refers to damage affecting the wider surroundings, such as the user's home or property.

Requirements related to the handling of the product are classified into the following categories.



- Marks indicating that an action is prohibited.

	<p>General Prohibition The indicated action is prohibited.</p>		<p>Example: Do Not Touch! Touching the specified location could result in injury.</p>
-----------------------------------------------------------------------------------	---------------------------------------------------------------------------	-----------------------------------------------------------------------------------	--------------------------------------------------------------------------------------------------

- Marks indicating that an action is prohibited.





	<p>General Caution Indicates a general need for caution that is not specified.</p>		<p>Example: Caution – Hot! Indicates the possibility of injury due to high temperature.</p>
-----------------------------------------------------------------------------------	-----------------------------------------------------------------------------------------------	-----------------------------------------------------------------------------------	--------------------------------------------------------------------------------------------------------

- Marks directing that the specified action is required.







	<p>General Instruction The specified action is required.</p>		<p>Example: Turn Off (Disconnect) Power Supply! Instructs the user to turn off (disconnect) the power supply to the product.</p>
-----------------------------------------------------------------------------------	-------------------------------------------------------------------------	-----------------------------------------------------------------------------------	---------------------------------------------------------------------------------------------------------------------------------------------

Warnings Regarding Use of the Product





■ Danger Items

 Danger	
  	<ul style="list-style-type: none"> • The product should be used only by persons (users) having a thorough knowledge of electrical and mechanical components and systems, a full knowledge of the risks associated with handling them, and training in inverter motor control and handling motors, or equivalent skills. Users should be limited to persons who have carefully read the Caution Items contained in this manual. • Unlike typical equipment, the product has no protective case to ensure safety, and it contains moving parts and high-temperature components that could be dangerous. Do not touch the evaluation board or cables while power is being supplied. • Carefully check to make sure that there are no pieces of conductive materials or dust adhering to the board, connectors, and cables. • There are moving parts, driven by a motor. Do not touch the motor while power is being supplied. • Ensure that the motor is insulated and placed in a stable location before supplying power.
	<p>Do Not Connect Load to Motor!</p> <ul style="list-style-type: none"> • This could cause fire, burns, or injury.

■ Warning Items

 Warning	
	<p>Caution – Rotating Parts!</p> <ul style="list-style-type: none"> The system includes a motor. Touching the rotating shaft could cause high-temperature burns or injury.
	<p>Always insert plugs, connectors, and cables securely, and confirm that they are fully inserted.</p> <ul style="list-style-type: none"> Incomplete connections could cause fire, burns, electric shock, or injury.
	<p>Use the power supply apparatus specified in the manual.</p> <ul style="list-style-type: none"> Failure to do so could cause fire, burns, electric shock, injury, or malfunction.
	<p>Disconnect the power supply and unplug all cables when the system will not be used for a period of time or when moving the system.</p> <ul style="list-style-type: none"> Failure to do so could cause fire, burns, electric shock, or malfunction. This will protect the system against damage due to lightning.
	<p>Use a mechanism (switch, outlet, etc.) located within reach to turn off (disconnect) the power supply.</p> <ul style="list-style-type: none"> In case of emergency, it may be necessary to cut off the power supply quickly.
	<p>Turn off the power supply immediately if you notice abnormal odor, smoke, abnormal sound, or overheating.</p> <ul style="list-style-type: none"> Continuing to use the system in an abnormal condition could cause fire, burns, or electric shock.
	<p>Do Not Disassemble, Modify, or Repair!</p> <ul style="list-style-type: none"> Doing so could cause fire, burns, electric shock, injury, or malfunction.
	<p>Do not use the product for any purpose other than initial evaluation of motor control in a testing room or lab. Do not integrate the product or any part of it into other equipment. Do not insert or remove cables or connectors when the product is powered on.</p> <ul style="list-style-type: none"> The product has no safety case. Failure to observe the above could cause fire, electric shock, burns, or malfunction. The product may not perform as expected if used for other than its intended purpose.

■ Caution Items

 Caution	
	<p>Caution – Hot!</p> <ul style="list-style-type: none"> The motor gets hot. Touching it could cause high-temperature burns.
	<p>Follow the procedure specified in the manual when powering the system on or off.</p> <ul style="list-style-type: none"> Failure to do so could cause overheating or malfunction.
	<p>Caution – Static Electricity</p> <ul style="list-style-type: none"> Use the antistatic band. Failure to do so could cause malfunction or unstable motion.

Overview

The RX66T CPU card (RTK0EMX870C00000BJ) is an optional board for use with the 24V Motor Control Evaluation System for RX23T (RTK0EM0006S01212BJ) (the Motor RSSK). The Motor RSSK comprises a 24V system inverter board (RTK0EM0001B00012BJ) (the INV-BRD) and a RX23T CPU card (RTK0EM0013C01201BJ) (the RX23T-CRD). By replacing the RX23T-CRD with the product, motor evaluation can be performed using the RX66T.

An emulator and equipment related to the Motor RSSK must be provided by the customer.

This user's manual describes the proper handling of the product. Content related to the product is presented in chapters 0 to 4 and 6 to 8. Content related to connection of the INV-BRD supplied with the Motor RSSK is presented in chapter 5. For details of the operation of the INV-BRD, refer to the Motor RSSK user's manual (R20UT3697EJ).

Target Device

RX66T microcontroller

Related Documents

- RX66T CPU Card Schematic : R12TU0049EJ
- RX66T CPU Card BOM List : R12TU0050EJ
- RX66T CPU Card PWB Pattern Drawing : R12TU0051EJ
- Renesas Solution Starter Kit
24V Motor Control Evaluation System for RX23T (Motor RSSK) User's Manual: R20UT3697EJ

Package Contents

- RX66T CPU Card Information
- Caution regarding the Motor Control Evaluation Board - RX66T CPU Card -

Abbreviations

Abbreviations	Full Name	Remarks
Motor RSSK	24V Motor Control Evaluation System for RX23T	Motor control evaluation kit for RX23T Product No.: RTK0EM0006S01212BJ
INV-BRD	24V Inverter Board	Inverter board supplied with motor control evaluation kit for RX23T Product No.: RTK0EM0001B00012BJ
RX23T-CRD	RX23T CPU Card	RX23T CPU card supplied with motor control evaluation kit for RX23T Product No.: RTK0EM0013C01201BJ
E1	E1 emulator	on-chip debugging emulator and flash programmer Product No.: R0E000010KCE00
E2 Lite	E2 emulator Lite	on-chip debugging emulator and flash programmer Product No.: RTE0T0002LKCE00000R

Contents

1. Features	6
2. Specifications	7
2.1 Specification	7
2.2 Regulatory Compliance Notices	8
2.2.1 European Union regulatory notices	8
3. Block Diagram	9
4. Layout	10
5. Usage	11
5.1 Quick Start	11
5.1.1 Preparation	11
5.1.2 Replacing the CPU card	11
5.1.3 Preparation for Operation Test	11
5.1.4 Operation Test	11
5.1.5 Finishing the Operation Test	11
5.2 Operation	12
5.2.1 Basic Operation	12
5.2.2 Canceling an Error State	12
5.3 In Case of Abnormal Odor, Smoke, Abnormal Sound, Overheating, Etc.	12
6. Functions	13
6.1 Power Supply	13
6.2 Connecting the Emulator	13
6.3 Connecting the Inverter Board	14
6.4 Connecting the Serial Communication	15
6.5 Hall Sensor Signal Input	15
6.6 Encoder Signal Input	16
6.7 Connecting the Extender Board	17
6.8 Extension of Unused Pins	18
6.9 Reset Circuit	19
6.10 Crystal Resonator	19
6.11 LEDs	19
6.12 JP1, JP2	19
7. Details of RX66T CPU Card	20
7.1 RX66T Features	20
7.2 RX66T Pin Assignments	21
7.3 List of RX66T Pin Functions	22
8. Caution Items	25

1. Features

1. Populated with RX66T 32-bit microcontroller suitable for inverter control.
2. CPU card designed specifically for use with INV-BRD supplied with Motor RSK.
3. Supports writing of software to flash memory using the E1 or E2 Lite.
4. Equipped with Hall sensor input connector and encoder input connector.
5. Equipped with serial communication connector.

2. Specifications

2.1 Specification

Table 2.1 Overview of RX66T CPU Card Specifications

Item	Specification
Product name	RX66T CPU card
Board product No.	RTK0EMX870C00000BJ
Supported inverter board / product No.	Supplied with 24V Motor Control Evaluation System for RX23T 24V Inverter Board / RTK0EM0001B00012BJ
Exterior view	

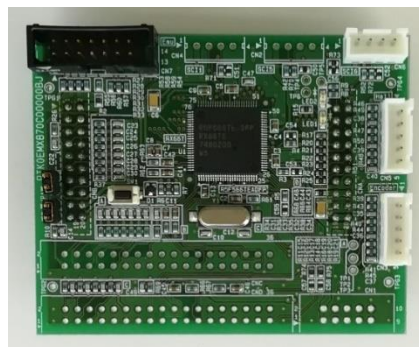

Note: Appearance of actual product may differ from photo.

MCU *1	Product group	RX66T group
	Product No.	R5F566TEADFP
	CPU max. operating frequency	160 MHz
	Bit count	32 bits
	Package / Pin count	LFQFP / 100 pins
	ROM	512 KB
	RAM	64KB
MCU input clock		8MHz
Input power supply voltage		DC 5 V ($\pm 5\%$) *2
		Selectable among the following:
		<ul style="list-style-type: none"> • Power supply from supported inverter board • Power supply from E1, E2 Lite *3
Supported sensors		Hall sensor, encoder (through holes provided for signal monitoring test pins)
Supported emulator		E1, E2 Lite
Connectors		<ul style="list-style-type: none"> • Inverter board connectors x 2 • Serial communication connectors x 3 • Emulator connector x 1 • Hall sensor signal input connector x 1 • Encoder signal input connector x 1 • Extender board connector x 2
Switch		MCU external reset switch
LEDs		User control LEDs x 2
Operating temperature		Room temperature
Operating humidity		No condensation

Note 1. Refer the latest Technical update for the equipped MCU. When you use the temperature sensor of MCU, note that Temperature Sensor Calibration Data Register (TSCDR) of the MCU is not available for the lot No.18JN001~18JN050 of this product.

Note 2. Supply voltage is DC 3.3V from E2 Lite.

Note 3. Power supply from E1 or E2 Lite is not supported when INV-BRD is connected.

2.2 Regulatory Compliance Notices

2.2.1 European Union regulatory notices

This product complies with the following EU Directives. (These directives are only valid in the European Union.)

CE Certifications:

- Electromagnetic Compatibility (EMC) Directive 2014/30/EU
EN61326-1 : 2013 Class A

WARNING: This is a Class A product. This equipment can cause radio frequency noise when used in the residential area. In such cases, the user/operator of the equipment may be required to take appropriate countermeasures under his responsibility.

- Information for traceability
 - Authorised representative
Name: Renesas Electronics Corporation
Address: Toyosu Foresia, 3-2-24, Toyosu, Koto-ku, Tokyo 135-0061, Japan
 - Manufacturer
Name: Renesas Electronics Corporation
Address: Toyosu Foresia, 3-2-24, Toyosu, Koto-ku, Tokyo 135-0061, Japan
 - Person responsible for placing on the market
Name: Renesas Electronics Europe GmbH
Address: Arcadiastrasse 10, 40472 Dusseldorf, Germany
 - Trademark and Type name
Trademark: Renesas
Product name: RX66T CPU Card for Motor Control
Type name: RTK0EMX870C00000BJ

Environmental Compliance and Certifications:

- Waste Electrical and Electronic Equipment (WEEE) Directive 2012/19/EU

3. Block Diagram

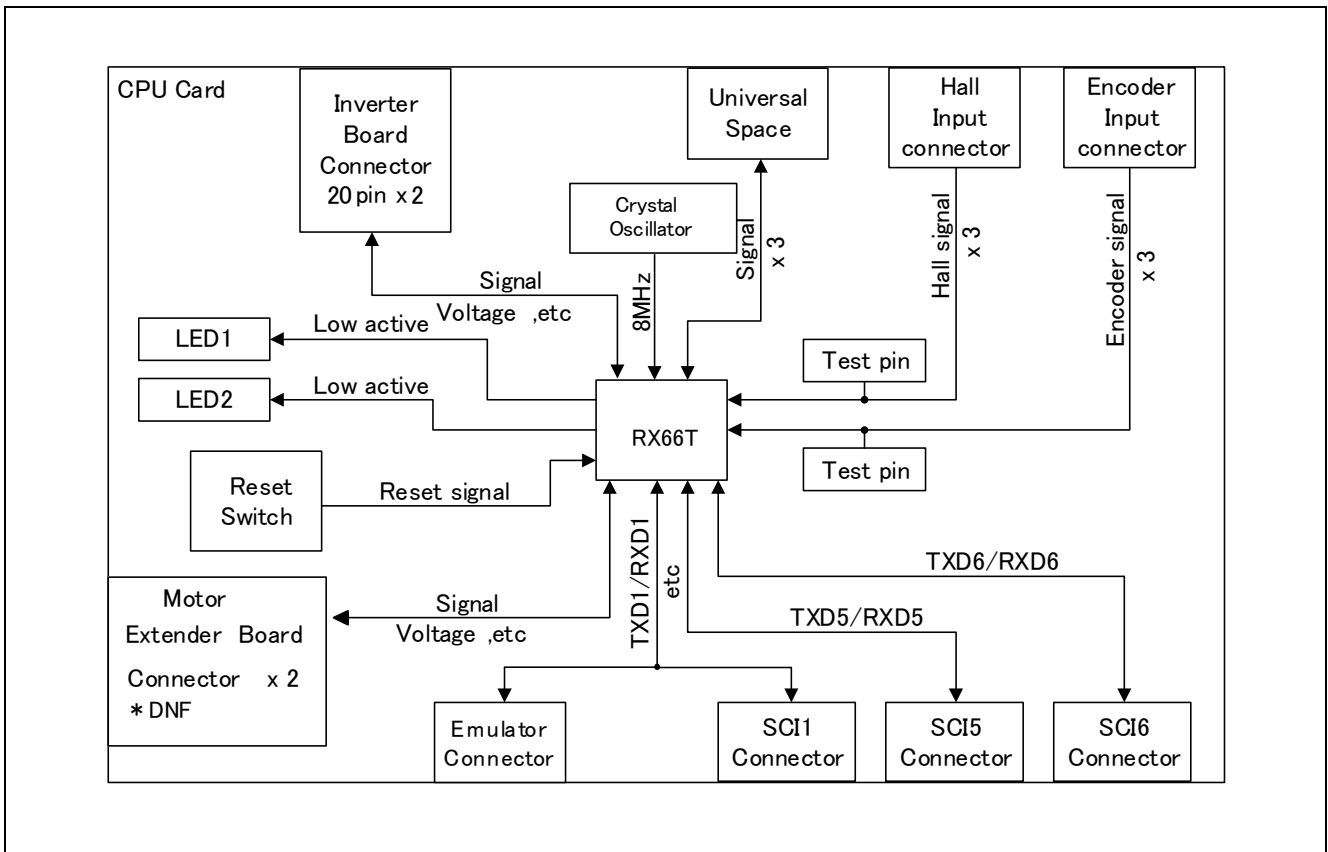

Figure 3.1 RX66T CPU Card Block Diagram

4. Layout

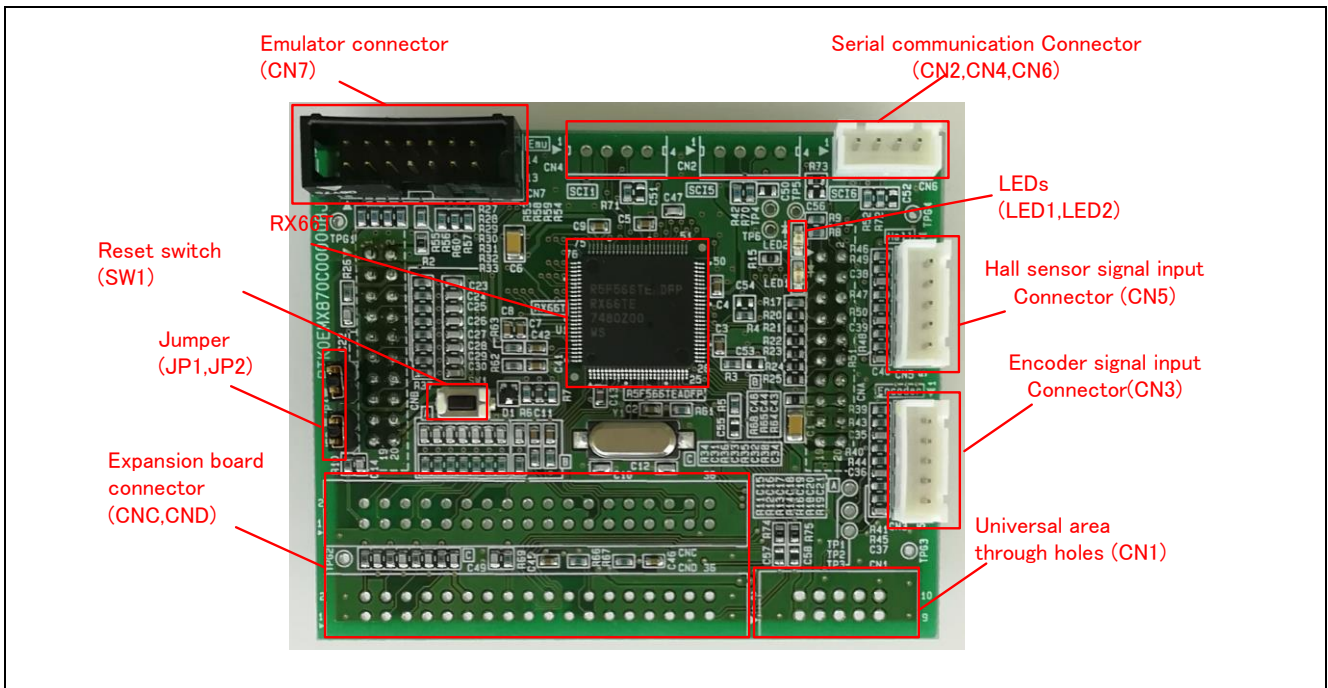

Figure 4.1 RX66T CPU Card Layout (Top View)

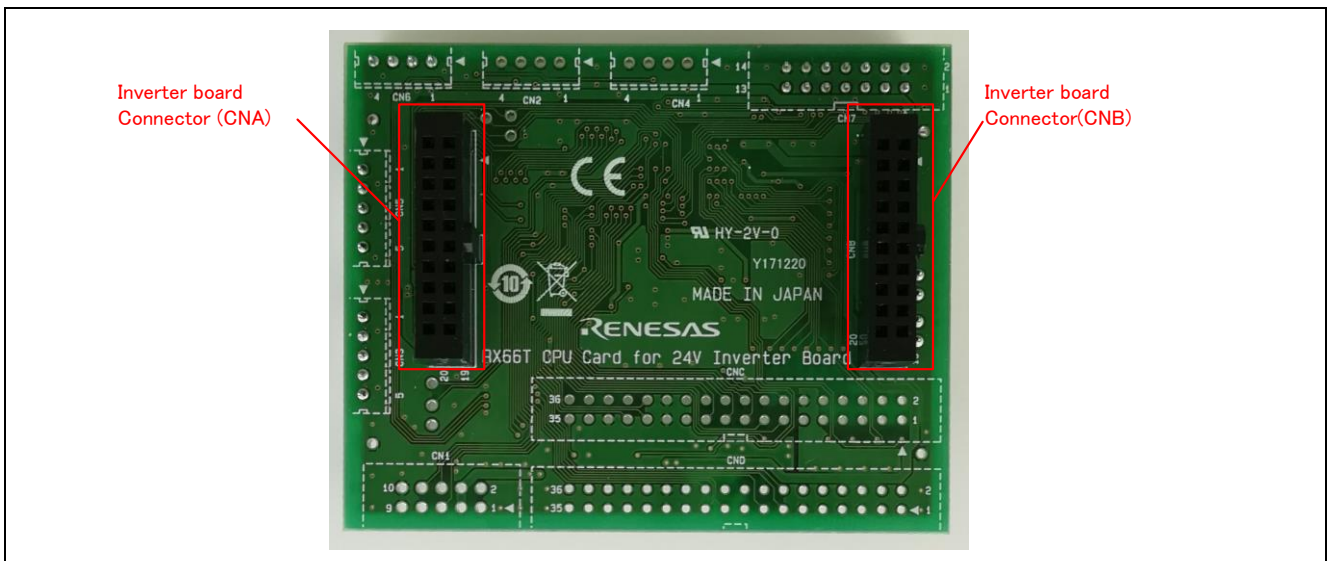

Figure 4.2 RX66T CPU Card Layout (Bottom View)

5. Usage

5.1 Quick Start

5.1.1 Preparation

Obtain the Motor RSSK, and perform the steps described in 5.1.1 and 5.1.2, Quick Start, of the user's manual. (R20UT3697EJ).

5.1.2 Replacing the CPU card

Confirm that the INV-BRD is powered off, remove the RX23T-CRD from the INV-BRD, and connect the product in its place.

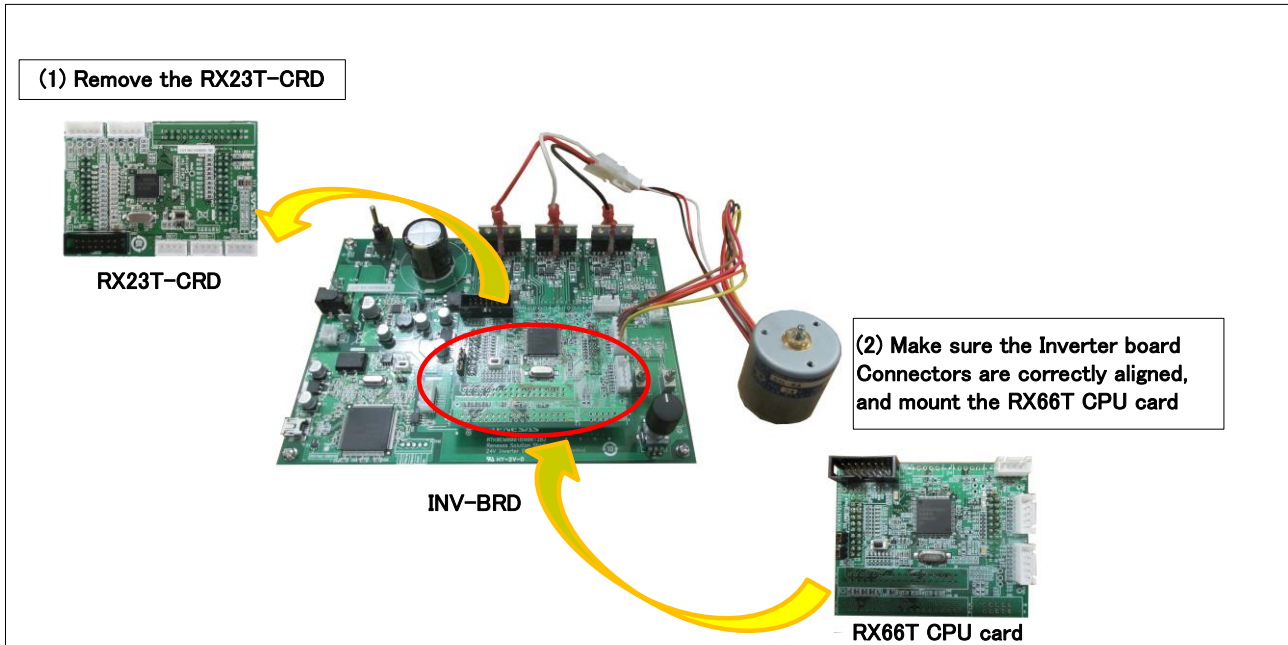

Figure 5.1 CPU card replacement

5.1.3 Preparation for Operation Test

Perform the steps described in 5.1.3 to 5.1.5 of the Motor RSSK user's manual (R20UT3697EJ) to prepare for motor drive.

5.1.4 Operation Test

Perform the steps described in 5.1.6 to 5.1.9 of the Motor RSSK user's manual (R20UT3697EJ) in the order indicated, turn on the power supply, enable motor rotation, change the motor rotation speed, and stop motor rotation.

5.1.5 Finishing the Operation Test

After the operation test is finished, confirm that the motor shaft is no longer rotating and turn off the stabilized power supply output.

5.2 Operation

5.2.1 Basic Operation

Out of the box the product is programmed with sensor-less vector control software for the RX66T. Table 5.1 lists the software specifications and the basic operations when connected to the INV-BRD.

Table 5.1 Initial Software Specifications

Item	Specification
Control method	Sensorless vector control
VR1	Clockwise turn: Motor shaft rotates clockwise. Counterclockwise turn: Motor shaft rotates counterclockwise.
SW1	ON: Motor rotation enabled OFF: Motor rotation disabled
SW2	Cancels error state: OFF → ON → OFF after an error:
LED1	ON: SW1 ON and normal state. OFF: SW1 OFF or error state.
LED2	ON: error state. OFF: normal state.

5.2.2 Canceling an Error State

If an error occurs, LED2 lights on the INV-BRD and the product, and motor rotation stops. To recover, it is necessary to turn off toggle switch SW1 and turn on toggle switch SW2 on the INV-BRD, and then turn off toggle switch SW2 again.

5.3 In Case of Abnormal Odor, Smoke, Abnormal Sound, Overheating, Etc.

The INV-BRD is equipped with a toggle switch (S1) to cut off the flow of current to the inverter. If an abnormal condition (such as abnormal odor, smoke, abnormal sound, or overheating) occurs, turn off S1 to cut off current flow to the inverter.

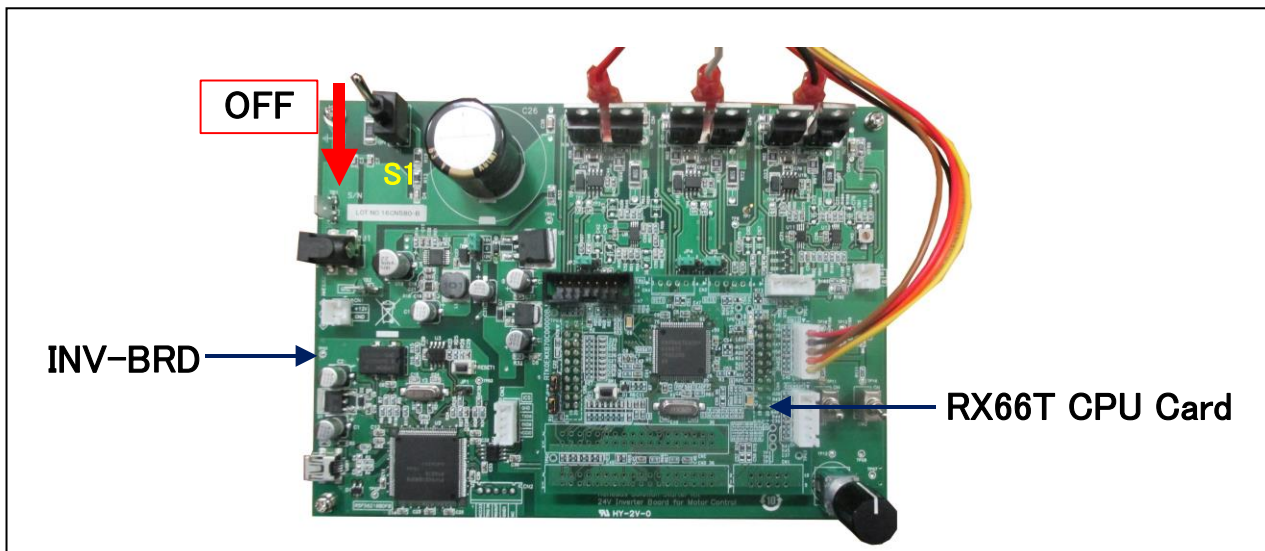

Figure 5.2 Cut off current

6. Functions

6.1 Power Supply

The product does not have a dedicated power supply connector. When connected to the INV-BRD it draws power via the connector. When not connected to the INV-BRD, it can draw power via the Emulator connector. The product is not allowed to draw power via the Emulator connector when it is connected to the INV-BRD.

6.2 Connecting the Emulator

The E1/E2 Lite on-chip debugging emulator from Renesas Electronics is used to write software (program) to the flash memory of the RX66T. Software will be downloaded into the product via E1 or E2 Lite. It is also necessary to make the settings shown in Table 6.1 in the integrated development environment to enable the emulator to supply power to the product. Table 6.2 lists the pin assignments of the Emulator connector.

Table 6.1 E1, E2 Lite Power Supply Settings

Connection to INV-BRD	Power Supply Setting of E1, E2 Emulator
Connected	Power supply is not allowed*1
Not connected	5.0V or 3.3V power supply

Note 1. When connected to the INV-BRD, the product must draw power from the INV-BRD.

Table 6.2 Pin Assignments of Emulator Connector (CN7)

Pin No.	Pin Function	RX66T Connection Pins	Pin No.	Pin Function	RX66T Connection Pins
1	TCK/FINEC	TCK	2	GND	VSS
3	TRST#	TRST#	4	EMLE	EMLE
5	TXD1/TDO	TXD1	6	NC	-
7	MD/FINED	MD/FINED	8	VCC	VCC
9	TMS	TMS	10	UB	UB
11	TDI/RXD1	RXD1	12	GND	VSS
13	RESET#	RES#	14	GND	VSS

Note: See a supplement to the E1/E20/E2 emulator, E2 emulator Lite user's manual.

6.3 Connecting the Inverter Board

The product connects to the INV-BRD via the inverter board connectors (CNA and CNB). Table 6.3 and Table 6.4 list the pin assignments of the inverter board connectors.

Table 6.3 Pin Assignments of Inverter Board Connector (CNA)

Pin No.	Pin Function	RX66T Connection Pins	Pin No.	Pin Function	RX66T Connection Pins
1	LED1#	PE3	2	LED2#	PB7
3	LED3#	PB3	4	NC	P24
5	FO#	P70/POE0#	6	NC	-
7	WN	P76/MTIOC4D	8	VN	P75/MTIOC4C
9	UN	P74/MTIOC3D	10	WP	P73/MTIOC4B
11	VP	P72/MTIOC4A	12	UP	P71/MTIOC3B
13	SW1#	P80	14	SW2#	P81
15	5V	VCC	16	5V	VCC
17	GND	VSS	18	GND	VSS
19	3.3V	-	20	3.3V	-

Table 6.4 Pin Assignments of Inverter Board Connector (CNB)

Pin No.	Pin Function	RX66T Connection Pins	Pin No.	Pin Function	RX66T Connection Pins
1	AVCC	AVCC	2	AVCC	AVCC
3	NC	-	4	PGAVSS1	PGAVSS0
5	IU	P40/AN000	6	IV	P41/AN001
7	IW	P42/AN002	8	VPN	P62/AN208
9	TEMP(VOT)	-	10	VU	P52/AN200
11	VV	P53/AN201	12	VW	P54/AN202
13	VAC	-	14	IPFC	-
15	VR1	P21/AN217	16	VN	-
17	VCCIO	VCC	18	VCCIO	VCC
19	GND	VSS	20	GND	VSS

6.4 Connecting the Serial Communication

The product communicates with the UART via the serial communication connectors. There are three serial communication connectors: CN4, CN6, and CN7. Table 6.5 lists their pin assignments. Use CN6 when using a tool such as waveform display in conjunction with the INV-BRD.

Table 6.5 Pin Assignments of Serial Communication Connectors (CN2, CN4, CN6)

Connector No.	Pin No.	Pin Function	RX66T Connection Pins
CN2 SCI5	1	5V	VCC
	2	RX66T transmit side	PB5/TXD5
	3	RX66T receive side	PB6/RXD5
	4	GND	VSS
CN4 SCI1	1	5V	VCC
	2	RX66T transmit side	PD3/TXD1**1
	3	RX66T receive side	PD5/RXD1**1
	4	GND	VSS
CN6 SCI6	1	5V	VCC
	2	RX66T transmit side	PB0/TXD6
	3	RX66T receive side	PB1/RXD6
	4	GND	VSS

Note 1. TXD / RXD of SCI1 is shared with E1, E2 Lite. Please do not use the SCI1 during E1 or E2 Lite connection.

6.5 Hall Sensor Signal Input

The product is equipped with a Hall sensor signal input connector. Using this connector, it is possible to input the Hall sensor signal from the motor supplied with the Motor RSSK directly to the product. The signal input to the product is pulled up to 5 V and passed through an RC filter before being input to the RX66T. Table 6.6 lists the pin assignments of the Hall sensor signal input connector, and Table 6.7 lists connector information.

Table 6.6 Pin Assignments of Hall Sensor Signal Input Connector (CN5)

Pin No.	Pin Function	RX66T Connection Pins
1	5V	VCC
2	GND	VSS
3	HU	PE0/IRQ7
4	HV	PE1/IRQ15
5	HW	PE5/IRQ0

Table 6.7 Hall Sensor Signal Input Connector Information

Part	Product No.	Manufacturer
Connector (CN5)	B5B-XH-A	J.S.T. Mfg. Co. Ltd.

6.6 Encoder Signal Input

The product is equipped with an encoder signal input connector. This makes it possible to input the encoder signal to the RX66T. The signal input to the product is pulled up to 5 V and passed through an RC filter before being input to the RX66T. Table 6.8 lists the pin assignments of the signal input connector, and Table 6.9 lists connector information.

Table 6.8 Pin Assignments of Encoder Signal Input Connector (CN3)

Pin No.	Pin Function	RX66T Connection Pins
1	5V	VCC
2	GND	VSS
3	Phase A	P33
4	Phase B	P32
5	Phase Z	PA5

Table 6.9 Encoder Signal Input Connector Information

Part	Product No.	Manufacturer
Connector (CN3)	B5B-XH-A	J.S.T. Mfg. Co. Ltd.

6.7 Connecting the Extender Board

This product is equipped with two Extender board Connector. This connector can connect Extender Board (RTK0EM0000Z02000BJ) via the cable. This makes it possible to control three INV-BRDs. In other words, this product can drive three motors. Table 6. 10 lists the pin assignments of the 2nd Extender board Connector. Table 6. 11 lists the pin assignments of the 3rd Extender board Connector. Note that the pin assignments of CND are different from those of CNC and that some pins of CND are pull-upped because of sharing the pins with CN7.

Table 6. 10 Pin Assignments of 2nd Extender boards Connector

CNC Pin No.	CNC Pin Function	RX66T Connection Pins	CNC Pin No.	CNC Pin Function	RX66T Connection Pins
1	PGAVSS_2	AVSS1	2	VPN_2	P63/AN209
3	IU_2	P44/AN100	4	IV_2	P45/AN101
5	IW_2	P46/AN102	6	TEMP_2	-
7	VU_2	P55/AN203	8	VV_2	P60/AN206
9	VW_2	P61/AN207	10	VR_2	-
11	GND	VSS	12	GND	AVSS
13	LED1#_2	PB2	14	-	PE2
15	LED3#_2	PA4	16	FO#_2	P96/POE4#
17	WN_2	P90/MTIOC7D	18	VN_2	P91/MTIOC7C
19	UN_2	P92/MTIOC6D	20	WP_2	P93/MTIOC7B
21	VP_2	P94/MTIOC7A	22	UP_2	P95/MTIOC6B
23	SW1#_2	P10	24	SW2#_2	P11
25	GND	VSS	26	GND	VSS
27	ENC_A_2	P31	28	ENC_B_2	P30
29	ENC_Z_2	PA3	30	GND	VSS
31	GND	VSS	32	HALL_U_2	P01/IRQ4
33	HALL_V_2	PE4/IRQ1	34	HALL_W_2	P00/IRQ2
35	VRL2	PD1	36	NC	-

Table 6. 11 Pin Assignments of 3rd Extender boards Connector

CND Pin No.	CND Pin Function	RX66T Connection Pins	CND Pin No.	CND Pin Function	RX66T Connection Pins
1	PGAVSS_3	-	2	VPN_3	P64/AN210
3	IU_3	P43/AN003	4	IV_3	P47/AN103
5	IW_3	P65/AN211	6	TEMP_3	-
7	VU_3	-	8	VV_3	-
9	VW_3	-	10	VR_3	-
11	GND	VSS	12	GND	AVSS
13	LED1#_3	PA0	14	LED2#_3	PA2
15	LED3#_3	PA1	16	FO#_3	PB4/POE8#
17	WN_3	PD2/GTIOC2B	18	WP_3	TXD1/GTIOC2A
19	VN_3	PD4/GTIOC1B	20	VP_3	RXD1/GTIOC1A
21	UN_3	TMS/GTIOC0B	22	UP_3	PD7/GTIOC0A
23	SW1#_3	P82	24	SW2#_3	P22
25	GND	VSS	26	GND	VSS
27	ENC_A_3	-	28	ENC_B_3	-
29	ENC_Z_3	-	30	GND	VSS
31	GND	VSS	32	HALL_U_3	-
33	HALL_V_3	-	34	HALL_W_3	-
36	VRL3	PD0	36	NC	-

6.8 Extension of Unused Pins

To facilitate general use of the product, the unused pins of the RX66T are extended through universal connector through holes in the board. Table 6.12 lists the pin assignments of the universal area through holes.

Table 6.12 Pin Assignments of Universal Area Through Holes (CN1)

Pin No.	RX66T Connection Pins	Pin No.	RX66T Connection Pins
1	UVCC	2	UVCC
3	AVCC	4	AVCC
5	P20	6	P23
7	-	8	P27
9	GND	10	GND

6.9 Reset Circuit

The product is equipped with a reset circuit for resetting the microcontroller at power-on reset and external reset. To apply an external reset to the microcontroller, press the pushbutton (SW1).

6.10 Crystal Resonator

This product is mounted crystal oscillator (Y1) on 8MHz.

6.11 LEDs

Two LEDs are mounted on the product for use in debugging programs and general system applications. Each turns on when the output on the corresponding port is low-level and turns off when the output is high-level. Table 6.13 lists the pin assignments corresponding to the LEDs.

Table 6.13 RX66T CPU Card LED Connection Pin Assignments

Corresponding RX66T Port		LED1	LED2
PE3	High-level output	Off	-
	Low-level output	On	-
PB7	High-level output	-	Off
	Low-level output	-	On

6.12 JP1, JP2

JP1 and JP2 should be short-circuited between 2-3Pin.

Table 6.14 Jumper JP1 and JP2 configuration

JP1, JP2 configuration	Function	
	JP1	JP2
Open	Connect MCU (PGAVSS0 pin) to CNC (1 pin)	Connect MCU (PGAVSS1 pin) to CNB (4 pin)
Short (At the time of shipment)	Connect MCU (PGAVSS0 pin) to GND	Connect MCU (PGAVSS1 pin) to GND

7. Details of RX66T CPU Card

7.1 RX66T Features

1. 32-bit microcontroller with RXv3 CPU core for motor control
2. On-chip 32-bit single-precision floating point unit (FPU)
3. Ability to output three-phase complementary PWM waveforms on three channels
4. Ability to set timer interrupt as A/D trigger
5. Three 12-bit A/D converter units with a total of 22 channels
6. Channel-dedicated sample and hold function
7. On-chip programmable gain amplifier and comparator
8. Timer output stop (Hi-Z) function
9. On-chip independent watchdog timer

7.2 RX66T Pin Assignments

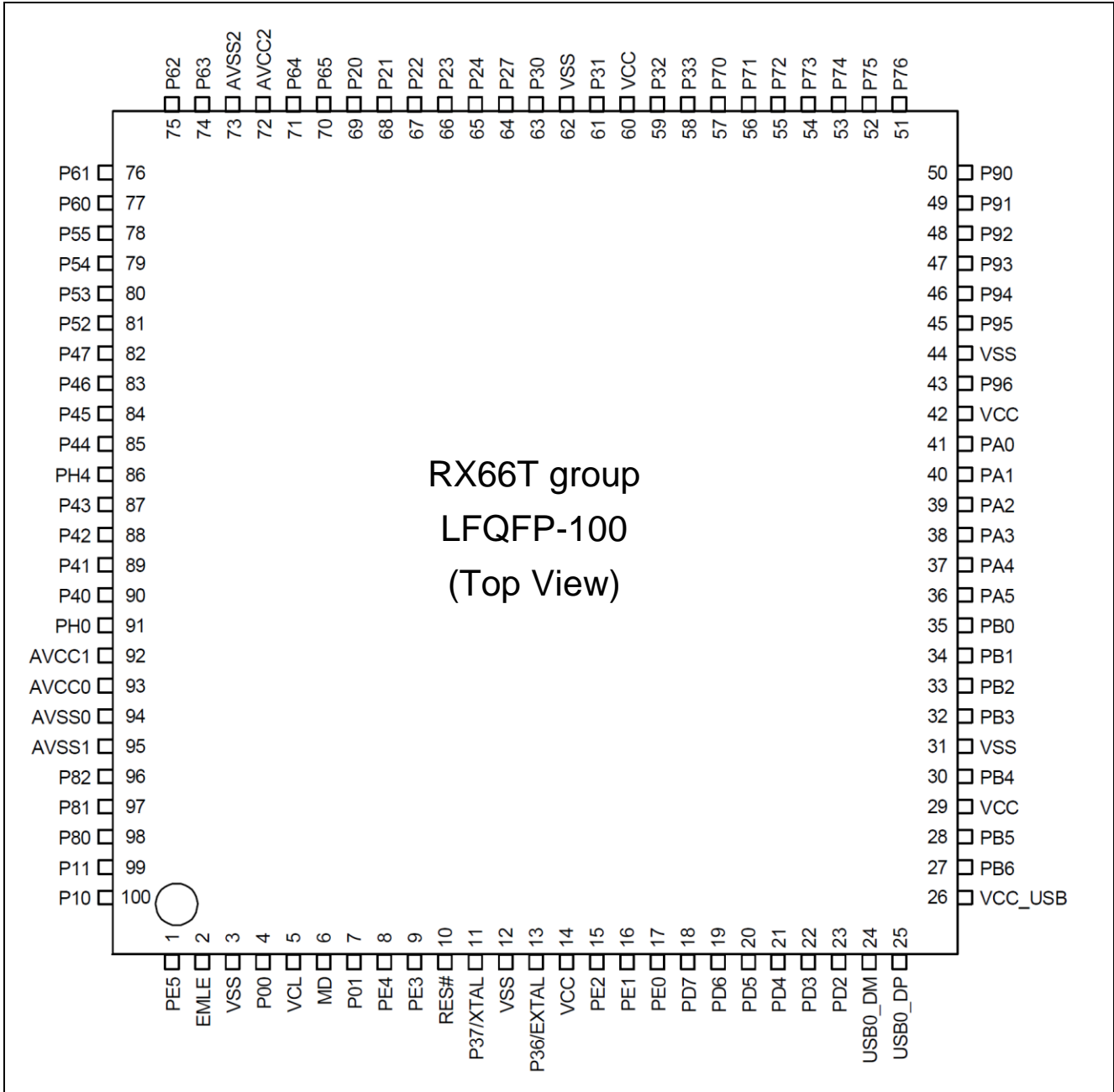

Figure 7.1 RX66T Pin Assignments

7.3 List of RX66T Pin Functions

Table 7.1 List of RX66T Pin Functions(1/3)

Pin No.	RX66T Pin Functions	CPU Card Connection	External Connection (N.C. : No connection)
1	PE5/BCLK/MTIOC9D/GTIOC3A/GTETRGB/GTETRGD /SCK9/CTS9#/RTS9#/SS9#/IRQ0/ADST0	CN5-5	HALL_W_1
2	EMLE	CN7-4	E1, E2 Lite
3	VSS	VSS	VSS
4	UB/P00/A11/MTIOC9A/CACREF/RXD9/SMISO9/SSCL9 /RXD12/SMISO12/SSCL12/RXDX12/IRQ2/ADST1/COMP0	CNC-34	HALL_W_2
5	VCL	Connect to capacitor	-
6	MD/FINED	CN7-7	E1, E2 Lite
7	P01/A10/MTIOC9C/GTETRGA/GTETRGB/GTETRGC /GTETRGD/POE12#/TXD9/SMOSI9/SSDA9/TXD12 /SMOSI12/SSDA12/TXDX12/SIOX12/IRQ4/ADST2/COMP1	CNC-32	HALL_U_2
8	PE4/A9/MTCLKC/GTETRGA/GTETRGB/GTETRGC /GTETRGD/POE10#/SCK9/IRQ1	CNC-33	HALL_V_2
9	PE3/A8/MTCLKD/GTETRGA/GTETRGB/GTETRGC /GTETRGD/POE11#/CTS9#/RTS9#/SS9#/IRQ2_DS	CNA-1	LED1#_1
10	RES#	RESET CN7-13	MCU RESET
11	XTAL/P37	Crystal oscillator (8MHz)	MCU oscillating
12	VSS	VSS	VSS
13	EXTAL/P36	Crystal oscillator (8MHz)	MCU oscillating
14	VCC	VCC	VCC
15	PE2/POE10#/NMI	CNC-14	-
16	PE1/WR0#/WR#/MTIOC9D/TMO5/CTS5#/RTS5#/SS5# /CTS12#/RTS12#/SS12#/SSLA3/IRQ15	CN5-4	HALL_V_1
17	PE0/WR1#/BC1#/WAIT#/MTIOC9B/TMCI1/TMCI5/RXD5 /SMISO5/SSCL5/SSLA2/CRX0/IRQ7	CN5-3	HALL_U_1
18	TRST#/PD7/MTIOC9A/GTIOC0A/GTIOC3A/TMRI1/TMRI5	CND-22	UP_3
19	TMS/PD6/MTIOC9C/GTIOC0B/GTIOC3B/TMO1/CTS1# /RTS1#/SS1#/CTS11#/RTS11#/SS11#/SSLA0/IRQ5/ADST0	CND-21	VP_3
20	TDI/PD5/GTIOC1A/GTETRGA/TMRI0/TMRI6/RXD1 /SMISO1/SSCL1/RXD11/SMISO11/SSCL11/IRQ6	CND-20	WP_3
21	TCK/FINEC/PD4/GTIOC1B/GTETRGB/TMCI0/TMCI6/SCK1 /SCK11/IRQ2	CND-19	UN_3
22	TDO/PD3/GTIOC2A/GTETRGC/TMO0/TXD1/SMOSI1 /SSDA1/TXD11/SMOSI11/SSDA11	CND-18	VN_3
23	TRCLK/PD2/A7/GTIOC2B/GTIOC0A/TMCI1/TMO4/SCK5 /SCK8/MOSIA	CND-17	WN_3
24	TRDATA3/PD1/A6/GTIOC3A/GTIOC0B/TMO2/RXD8 /SMISO8/SSCL8/MISOA	CNC-35	VRL_2
25	TRDATA2/PD0/A5/GTIOC3B/GTIOC1A/TMO6/TXD8 /SMOSI8/SSDA8/RSPCKA	CND-35	VRL_3
26	TRDATA1/PB7/A4/GTIOC1B/SCK5/SCK11/SCK12	CNA-2	LED2#_1
27	TRDATA0/PB6/A3/GTIOC2A/RXD5/SMISO5/SSCL5/RXD11 /SMISO11/SSCL11/RXD12/SMISO12/SSCL12/RXDX12 /CRX0/IRQ2	CN2-3	SCI5 communication (Combined with CAN communication)

Table 7.2 List of RX66T Pin Functions(2/3)

28	TRSYNC/PB5/A2/GTIOC2B/TXD5/SMOSI5/SSDA5/TXD11 /SMOSI11/SSDA11/TXD12/SMOSI12/SSDA12/TXD12 /SIOX12/CTX0	CN2-2	SCI5 communication (Combined with CAN communication)
29	VCC	VCC	VCC
30	PB4/A1/GTETRGA/GTETRGB/GTETRGC/GTETRGD /POE8#/CTS5#/RTS5#/SS5#/SCK11/CTS11#/RTS11# /SS11#/IRQ3_DS	CND-16	FO#_3
31	VSS	VSS	VSS
32	PB3/MTIOC0A/CACREF/SCK6/RSPCKA/IRQ9	CNA-3	LED3#_1
33	PB2/MTIOC0B/GTADSM0/TMRI0/TXD6/SMOSI6/SSDA6 /SDA/ADSM0	CNC-13	LED1#_2
34	PB1/MTIOC0C/GTADSM1/TMCI0/RXD6/SMISO6/SSCL6 /SCL/IRQ4/ADSM1	CN6-3	SCI6 communication
35	PB0/A0/BC0#/MTIOC0D/TMO0/TXD6/SMOSI6/SSDA6 /CTS11#/RTS11#/SS11#/MOSIA/IRQ8/ADTRG2#	CN6-2	SCI6 communication
36	PA5/MTIOC1A/TMCI3/RXD6/SMISO6/SSCL6/RXD8 /SMISO8/SSCL8/MISOA/IRQ1/ADTRG1#	CN3-5	ENC_Z_1
37	PA4/MTIOC1B/TMCI7/SCK6/TXD8/SMOSI8/SSDA8 /RSPCKA/ADTRG0#	CNC-15	LED3#_2
38	PA3/MTIOC2A/GTADSM0/TMRI7/TXD9/SMOSI9/SSDA9 /SCK8/SSLA0	CNC-29	ENC_Z_2
39	PA2/A0/BC0#/MTIOC2B/GTADSM1/TMO7/CTS6#/RTS6# /SS6#/RXD9/SMISO9/SSCL9/SSLA1	CND-14	LED2#_3
40	PA1/MTIOC6A/TMO4/TXD9/SMOSI9/SSDA9/RXD11 /SMISO11/SSCL11/SSLA2/CRX0/IRQ14_DS/ADTRG0#	CND-15	LED3#_3
41	PA0/MTIOC6C/TMO2/SCK9/TXD11/SMOSI11/SSDA11 /SSLA3/CTX0	CND-13	LED1#_3
42	VCC	VCC	VCC
43	P96/CS0#/WAIT#/GTETRGA/GTETRGB/GTETRGC /GTETRGD/POE4#/CTS8#/RTS8#/SS8#/IRQ4_DS	CNC-16	FO#_2
44	VSS	VSS	VSS
45	P95/MTIOC6B/GTIOC4A/GTIOC7A	CNC-22	UP_2
46	P94/MTIOC7A/GTIOC5A/GTIOC8A	CNC-21	VP_2
47	P93/MTIOC7B/GTIOC6A/GTIOC9A	CNC-20	WP_2
48	P92/MTIOC6D/GTIOC4B/GTIOC7B	CNC-19	UN_2
49	P91/MTIOC7C/GTIOC5B/GTIOC8B	CNC-18	VN_2
50	P90/MTIOC7D/GTIOC6B/GTIOC9B	CNC-17	WN_2
51	P76/D0/MTIOC4D/GTIOC2B/GTIOC6B	CNA-7	WN_1
52	P75/D1/MTIOC4C/GTIOC1B/GTIOC5B	CNA-8	VN_1
53	P74/D2/MTIOC3D/GTIOC0B/GTIOC4B	CNA-9	UN_1
54	P73/D3/MTIOC4B/GTIOC2A/GTIOC6A	CNA-10	WP_1
55	P72/D4/MTIOC4A/GTIOC1A/GTIOC5A/ /	CNA-11	VP_1
56	P71/D5/MTIOC3B/GTIOC0A/GTIOC4A/ /	CNA-12	UP_1
57	P70/D6/GTETRGA/GTETRGB/GTETRGC/GTETRGD /POE0#/CTS9#/RTS9#/SS9#/IRQ5_DS	CNA-5	FO#_1
58	P33/D7/MTIOC3A/MTCLKA/GTIOC3B/TMO0/SSLA3 /IRQ13_DS	CN3-3	ENC_A_1
59	P32/D8/MTIOC3C/MTCLKB/GTIOC3A/TMO6/SSLA2 /IRQ12_DS	CN3-4	ENC_B_1
60	VCC	VCC	VCC
61	P31/D9/MTIOC0A/MTCLKC/TMRI6/SSLA1/IRQ6	CNC-27	ENC_A_2
62	VSS	VSS	VSS

Table 7.3 List of RX66T Pin Functions(3/3)

63	P30/D10/MTIOC0B/MTCLKD/TMCI6/SCK8/CTS8#/RTS8# /SS8#/SSLA0/IRQ7/COMP3	CNC-28	ENC_B_2
64	P27/MTIOC1A/MTIOC0C//POE9#/IRQ15	CN1-10	N.C
65	P24/D11/MTIC5U/TMCI2/TMO6/CTS8#/RTS8#/SS8#/ SCK8/RSPCKA/IRQ4/COMP0	CNA-4	VRL_1
66	P23/D12/MTIC5V/TMO2/CACREF/TXD8/SMOSI8/SSDA8 /TXD12/SMOSI12/SSDA12/TXDX12/SIOX12/MOSIA/CTX0 /IRQ11/COMP1	CN1-8	N.C
67	P22/D13/MTIC5W/MTCLKD/MTIOC9B/TMRI2/TMO4/RXD8 /SMISO8/SSCL8/RXD12/SMISO12/SSCL12/RXDX12 /MISOA/CRX0/IRQ10/ADTRG2#/COMP2	CND-24	SW2#_3
68	P21/D14/MTIOC9A/MTCLKA/TMCI4/TXD8/SMOSI8/SSDA8 /TXD12/SMOSI12/SSDA12/TXDX12/SIOX12/MOSIA /IRQ6_DS/AN217/ADTRG1#/COMP5	CNB-15	VR_1
69	P20/D15/MTIOC9C/MTCLKB/TMRI4/CTS8#/RTS8#/SS8# /SCK8/RSPCKA/IRQ7_DS/AN216/ADTRG0#/COMP4	CN1-7	N.C
70	P65/A12/IRQ9/AN211/CMPC53/DA1	CND-5	IW_3
71	P64/A13/IRQ8/AN210/CMPC33/DA0	CND-2	VPN_3
72	AVCC2	AVCC	AVCC
73	AVSS2	AVCC	AVCC
74	P63/A14/IRQ7/AN209/CMPC23	CNC-2	VPN_2
75	P62/A15/IRQ6/AN208/CMPC43	CNB-8	VPN_1
76	P61/A16/IRQ5/AN207/CMPC13	CNC-9	VW_2
77	P60/A17/IRQ4/AN206/CMPC03	CNC-8	VV_2
78	P55/A18/IRQ3/AN203/CMPC32	CNC-7	VU_2
79	P54/A19/IRQ2/AN202/CMPC22	CNB-12	VW_1
80	P53/A20/IRQ1/AN201/CMPC12	CNB-11	VV_1
81	P52/IRQ0/AN200/CMPC02	CNB-10	VU_1
82	P47/AN103	CND-4	IV_3
83	P46/AN102/CMPC50/CMPC51	CNC-5	IW_2
84	P45/AN101/CMPC40/CMPC41	CNC-4	IV_2
85	P44/AN100/CMPC30/CMPC31	CNC-3	IU_2
86	PH4/AN107/PGAVSS1	CNC-1	PGAVSS_2
87	P43/AN003	CND-3	IU_3
88	P42/AN002/CMPC20/CMPC21	CNB-7	IW_1
89	P41/AN001/CMPC10/CMPC11	CNB-6	IV_1
90	P40/AN000/CMPC00/CMPC01	CNB-5	IU_1
91	PH0/AN007/PGAVSS0	CNB-4	PGAVSS_1
92	AVCC1	AVCC	AVCC
93	AVCC0	AVCC	AVCC
94	AVSS0	AVSS	AVSS
95	AVSS1	AVSS	AVSS
96	P82/ALE/WAIT#/MTIC5U/TMO4/SCK6/SCK12/IRQ3/COMP5	CND-23	SW1#_3
97	P81/CS2#/MTIC5V/TMCI4/TXD6/SMOSI6/SSDA6/TXD12 /SMOSI12/SSDA12/TXDX12/SIOX12/COMP4	CNA-14	SW2#_1
98	P80/CS1#/MTIC5W/TMRI4/RXD6/SMISO6/SSCL6/RXD12 /SMISO12/SSCL12/RXDX12/IRQ5/COMP3	CNA-13	SW1#_1
99	P11/RD#/MTIOC3A/MTCLKC/MTIOC9D/GTIOC3B /GTETRGA/GTETRGC/TMO3/POE9#/IRQ1_DS	CNC-24	SW2#_2
100	P10/MTIOC9B/MTCLKD/GTETRGB/GTETRGD/TMRI3 /POE12#	CNC-23	SW1#_2

8. Caution Items

The product includes some unused pins that have not been processed. For information on accurate pin processing, refer to the hardware manual of the microcontroller.

Website and Support

Renesas Electronics Website

<http://www.renesas.com/>

Inquiries

<http://www.renesas.com/contact/>

All trademarks and registered trademarks are the property of their respective owners.

Revision History

Rev.	Date	Description	
		Page	Summary
1.00	Oct. 30, 2018	-	First edition issued
1.10	Feb. 21, 2019	22	Correct Table 7.1

Notice

1. Descriptions of circuits, software and other related information in this document are provided only to illustrate the operation of semiconductor products and application examples. You are fully responsible for the incorporation or any other use of the circuits, software, and information in the design of your product or system. Renesas Electronics disclaims any and all liability for any losses and damages incurred by you or third parties arising from the use of these circuits, software, or information.
2. Renesas Electronics hereby expressly disclaims any warranties against and liability for infringement or any other claims involving patents, copyrights, or other intellectual property rights of third parties, by or arising from the use of Renesas Electronics products or technical information described in this document, including but not limited to, the product data, drawings, charts, programs, algorithms, and application examples.
3. No license, express, implied or otherwise, is granted hereby under any patents, copyrights or other intellectual property rights of Renesas Electronics or others.
4. You shall not alter, modify, copy, or reverse engineer any Renesas Electronics product, whether in whole or in part. Renesas Electronics disclaims any and all liability for any losses or damages incurred by you or third parties arising from such alteration, modification, copying or reverse engineering.
5. Renesas Electronics products are classified according to the following two quality grades: "Standard" and "High Quality". The intended applications for each Renesas Electronics product depends on the product's quality grade, as indicated below.
"Standard": Computers; office equipment; communications equipment; test and measurement equipment; audio and visual equipment; home electronic appliances; machine tools; personal electronic equipment; industrial robots; etc.
"High Quality": Transportation equipment (automobiles, trains, ships, etc.); traffic control (traffic lights); large-scale communication equipment; key financial terminal systems; safety control equipment; etc.
Unless expressly designated as a high reliability product or a product for harsh environments in a Renesas Electronics data sheet or other Renesas Electronics document, Renesas Electronics products are not intended or authorized for use in products or systems that may pose a direct threat to human life or bodily injury (artificial life support devices or systems; surgical implantations; etc.), or may cause serious property damage (space system; undersea repeaters; nuclear power control systems; aircraft control systems; key plant systems; military equipment; etc.). Renesas Electronics disclaims any and all liability for any damages or losses incurred by you or any third parties arising from the use of any Renesas Electronics product that is inconsistent with any Renesas Electronics data sheet, user's manual or other Renesas Electronics document.
6. When using Renesas Electronics products, refer to the latest product information (data sheets, user's manuals, application notes, "General Notes for Handling and Using Semiconductor Devices" in the reliability handbook, etc.), and ensure that the usage conditions are within the ranges specified by Renesas Electronics with respect to maximum ratings, operating power supply voltage range, heat dissipation characteristics, installation, etc. Renesas Electronics disclaims any and all liability for any malfunctions, failure or accident arising out of the use of Renesas Electronics products outside of such specified ranges.
7. Although Renesas Electronics endeavors to improve the quality and reliability of Renesas Electronics products, semiconductor products have specific characteristics, such as the occurrence of failure at a certain rate and malfunctions under certain use conditions. Unless designated as a high reliability product or a product for harsh environments in a Renesas Electronics data sheet or other Renesas Electronics document, Renesas Electronics products are not subject to radiation resistance design. You are responsible for implementing safety measures to guard against the possibility of bodily injury, injury or damage caused by fire, and/or danger to the public in the event of a failure or malfunction of Renesas Electronics products, such as safety design for hardware and software, including but not limited to redundancy, fire control and malfunction prevention, appropriate treatment for aging degradation or any other appropriate measures. Because the evaluation of microcomputer software alone is very difficult and impractical, you are responsible for evaluating the safety of the final products or systems manufactured by you.
8. Please contact a Renesas Electronics sales office for details as to environmental matters such as the environmental compatibility of each Renesas Electronics product. You are responsible for carefully and sufficiently investigating applicable laws and regulations that regulate the inclusion or use of controlled substances, including without limitation, the EU RoHS Directive, and using Renesas Electronics products in compliance with all these applicable laws and regulations. Renesas Electronics disclaims any and all liability for damages or losses occurring as a result of your noncompliance with applicable laws and regulations.
9. Renesas Electronics products and technologies shall not be used for or incorporated into any products or systems whose manufacture, use, or sale is prohibited under any applicable domestic or foreign laws or regulations. You shall comply with any applicable export control laws and regulations promulgated and administered by the governments of any countries asserting jurisdiction over the parties or transactions.
10. It is the responsibility of the buyer or distributor of Renesas Electronics products, or any other party who distributes, disposes of, or otherwise sells or transfers the product to a third party, to notify such third party in advance of the contents and conditions set forth in this document.
11. This document shall not be reprinted, reproduced or duplicated in any form, in whole or in part, without prior written consent of Renesas Electronics.
12. Please contact a Renesas Electronics sales office if you have any questions regarding the information contained in this document or Renesas Electronics products.
(Note 1) "Renesas Electronics" as used in this document means Renesas Electronics Corporation and also includes its directly or indirectly controlled subsidiaries.
(Note 2) "Renesas Electronics product(s)" means any product developed or manufactured by or for Renesas Electronics.

以下“注意事项”为从英语原稿翻译的中文译文，仅作为参考译文，英文版的“Notice”具有正式效力。

注意事项

1. 本文件中所记载的关于电路、软件和其他相关信息仅用于说明半导体产品的操作和应用实例。用户如在产品或系统设计中应用本文件中的电路、软件及相关信息或将此等内容用于其他目的时，请自行负责。对于用户或第三方因使用上述电路、软件或信息而遭受的任何损失和损害，瑞萨电子不承担任何责任。
2. 瑞萨电子在此明确声明，对于因使用瑞萨电子产品或本文件中所述技术信息（包括但不限于产品数据、图、表、程序、算法、应用实例）而造成的与第三方专利、版权或其他知识产权相关的侵权或任何其他索赔，瑞萨电子不作任何保证并不承担责任。
3. 本文件所记载的内容不应视为对瑞萨电子或其他人所有的专利、版权或其他知识产权作出任何明示、默示或其它方式的许可及授权。
4. 用户不得对瑞萨电子的任何产品进行全部或部分更改、修改、复制或反向工程。对于用户或第三方因上述更改、修改、复制或反向工程的行为而遭受的任何损失或损害，瑞萨电子不承担任何责任。
5. 瑞萨电子产品根据其质量等级分为两个等级：“标准等级”和“高质量等级”。每种瑞萨电子产品的预期用途均取决于产品的质量等级，如下所示：
标准等级：计算机、办公设备、通讯设备、测试和测量设备、视听设备、家用电器、机械工具、个人电子设备、工业机器人等。
高质量等级：运输设备（汽车、火车、轮船等）、交通控制系统（交通信号灯）、大型通讯设备、关键金融终端系统、安全控制设备等。
除非瑞萨电子产品数据表或其他瑞萨电子文档中明确指定为高可靠性产品或用于恶劣环境的产品，否则瑞萨电子产品不能用于、亦未授权用于可能对人类生命造成直接威胁的产品或系统及可能造成人身伤害的产品或系统（人工生命维持装置或系统、植入于体内的装置等）中，或者可能造成重大财产损失的产品或系统（太空系统、海底增音机、核能控制系统、飞机控制系统、关键装置系统、军用设备等）中。对于用户或任何第三方因使用不符合瑞萨电子产品数据表、使用说明书或其他瑞萨电子文档的瑞萨电子产品而遭受的任何损害或损失，瑞萨电子不承担任何责任。
6. 使用瑞萨电子产品时，请参阅最新产品信息（数据表、使用说明书、应用指南、可靠性手册中的“半导体元件处理和一般注意事项”等），并确保使用条件在瑞萨电子指定的最大额定值、电源工作电压范围、散热特性、安装条件等范围内使用。对于在上述指定范围之外使用瑞萨电子产品而产生的任何故障、失效或事故，瑞萨电子不承担任何责任。
7. 虽然瑞萨电子一直致力于提高瑞萨电子产品的质量和可靠性，但是，半导体产品有其自身的具体特性，如一定的故障发生率以及在某些使用条件下会发生故障等。除非瑞萨电子产品数据表或其他瑞萨电子文档中指定为高可靠性产品或用于恶劣环境的产品，否则瑞萨电子产品未进行防辐射设计。用户负责执行安全措施，以避免因瑞萨电子产品失效或发生故障而造成身体伤害、火灾导致伤害或损害和/或其他对公众构成危险事故。例如进行软硬件安全设计（包括但不限于冗余设计、防火控制以及故障预防等）、适当的老化处理或其他适当的措施等。由于对微机电软件单独进行评估非常困难且并不实际，所以请用户自行负责对最终产品或系统进行安全评估。
8. 关于环境保护方面的详细内容，例如每种瑞萨电子产品的环境兼容性等，请与瑞萨电子的营业部门联系。用户负责仔细并充分查阅对管制物质的使用或含量进行管理的所有适用法律法规（包括但不限于《欧盟RoHS指令》），并在使用瑞萨电子产品时遵守所有适用法律法规。对于因用户未遵守相应适用法律法规而导致的损害或损失，瑞萨电子不承担任何责任。
9. 不可将瑞萨电子产品和技术用于或者嵌入日本国内或海外相应的法律所禁止生产、使用及销售的任何产品或系统中。也不可将其用于(1)与大规模杀伤性武器（例如核武器、化学武器、生物武器或运这些武器的手段，包括无人机(UAV)的开发、设计、制造、使用、存储等相关的任何目的；(2)与常规武器的开发、设计、制造或使用相关的任何目的；(3)扰乱国际和平与安全的任何其他目的，并且不可向任何第三方销售、出口、租赁、转让、或让与瑞萨电子产品或技术，无论直接或间接知悉或者有理由知悉该第三方或任何其他方将从从事上述活动。用户必须遵守对各方或交易行司法管辖权的任意国家和地区政府所公布和管理的任何适用出口管制法律法规。
10. 瑞萨电子产品的买方或分销商，或者分销、处置产品，或以其他方式向第三方出售或转让产品的任何其他方有责任事先向所述第三方通知本文件规定的内容和条件。
11. 在事先未得到瑞萨电子书面认可的情况下，不得以何形式部分或全部再版、转载或复制本文件。
12. 如果对本文件所记载的信息或瑞萨电子产品有任何疑问，请向瑞萨电子的营业部门咨询。
(注1) 瑞萨电子：在本文件中指瑞萨电子株式会社及其控股子公司。
(注2) 瑞萨电子产品：指瑞萨电子开发或生产的任何产品。

(Rev.4.0-1 November 2017)



Renesas Electronics Corporation

<http://www.renesas.com>

SALES OFFICES

Refer to "<http://www.renesas.com/>" for the latest and detailed information.

Renesas Electronics Corporation
TOYOSU FORESIA, 3-2-24 Toyosu, Koto-ku, Tokyo 135-0061, Japan

Renesas Electronics America Inc.
1001 Murphy Ranch Road, Milpitas, CA 95035, U.S.A.
Tel: +1-408-432-8888, Fax: +1-408-434-5351

Renesas Electronics Canada Limited
9251 Yonge Street, Suite 8309 Richmond Hill, Ontario Canada L4C 9T3
Tel: +1-905-237-2004

Renesas Electronics Europe Limited
Dukes Meadow, Millboard Road, Bourne End, Buckinghamshire, SL8 5FH, U.K.
Tel: +44-1628-651-700

Renesas Electronics Europe GmbH
Arcadialstrasse 10, 40472 Düsseldorf, Germany
Tel: +49-211-6503-0, Fax: +49-211-6503-132

Renesas Electronics (China) Co., Ltd.
Room 1709 Quantum Plaza, No.27 ZhichunLu, Haidian District, Beijing, 100191 P. R. China
Tel: +86-10-8235-1155, Fax: +86-10-8235-7679

Renesas Electronics (Shanghai) Co., Ltd.
Unit 301, Tower A, Central Towers, 555 Langan Road, Putuo District, Shanghai, 200333 P. R. China
Tel: +86-21-2226-0898, Fax: +86-21-2226-0989

Renesas Electronics Hong Kong Limited
Unit 1601-1611, 16/F., Tower 2, Grand Century Place, 193 Prince Edward Road West, Mongkok, Kowloon, Hong Kong
Tel: +852-2265-6688, Fax: +852-2886-9022

Renesas Electronics Taiwan Co., Ltd.
13F, No. 363, Fu Shing North Road, Taipei 10543, Taiwan
Tel: +886-2-8175-9600, Fax: +886-2-8175-9670

Renesas Electronics Singapore Pte. Ltd.
80 Bendemeer Road, Unit #06-02 Hyflux Innovation Centre, Singapore 339949
Tel: +65-6213-0200, Fax: +65-6213-0300

Renesas Electronics Malaysia Sdn. Bhd.
Unit 1207, Block B, Menara Amcorp, Amcorp Trade Centre, No. 18, Jin Persiaran Barat, 46050 Petaling Jaya, Selangor Darul Ehsan, Malaysia
Tel: +60-3-7955-9390, Fax: +60-3-7955-9510

Renesas Electronics India Pvt. Ltd.
No.77C, 100 Feet Road, HAL 2nd Stage, Indiranagar, Bangalore 560 038, India
Tel: +91-80-67208700, Fax: +91-80-67208777

Renesas Electronics Korea Co., Ltd.
17F, KAMCO Yangjae Tower, 262, Gangnam-daero, Gangnam-gu, Seoul, 06265 Korea
Tel: +82-2-558-3737, Fax: +82-2-558-8338

© 2019 Renesas Electronics Corporation. All rights reserved.

Colophon 7.2

Mouser Electronics

Authorized Distributor

Click to View Pricing, Inventory, Delivery & Lifecycle Information:

[Renesas Electronics:](#)

[RTK0EMX870C00000BJ](#)