

Common Mode Filter with ESD Protection

> 900 MHz Common Mode Stop Band Attenuation for HDMI Interfaces



ON Semiconductor®

www.onsemi.com

EMI804x Series

Functional Description

The EMI804x is a family of Common Mode Filters (CMF) with integrated ESD protection, a first in the industry. Differential signaling I/Os can now have both common mode filtering and ESD protection in one package. The EMI804x protects against ESD pulses up to ±15 kV contact per the IEC61000-4-2 standard.

The EMI804x is well-suited for protecting systems using high-speed differential ports such as USB 3.0, HDMI 1.3/1.4/2.0; corresponding ports in removable storage and other applications.

The EMI804x is available in a RoHS-compliant, XDFN6 for 1 Differential Pair, XDFN10 for 2 Differential Pair and XDFN16 package for 3 Differential Pair.

Features

- Total Insertion Loss $DM_{LOSS} < 2.5$ dB at 2.5 GHz
- Large Differential Mode Cutoff Frequency $f_{3dB} > 5$ GHz
- High Common Mode Stop Band Attenuation:
15 dB at 700 MHz, 30 dB at 2.4 GHz
- Low Channel Resistance 6.0 Ω
- Provides ESD Protection to IEC61000-4-2 Level 4, ±15 kV Contact
- SZ Prefix for Automotive and Other Applications Requiring Unique Site and Control Change Requirements; AEC-Q101 Qualified and PPAP Capable
- These Devices are Pb-Free, Halogen Free/BFR Free and are RoHS Compliant

Applications

- USB 3.0
- HDMI 1.3/1.4/2.0
- MHL 2.0
- ESATA
- Automotive Cameras

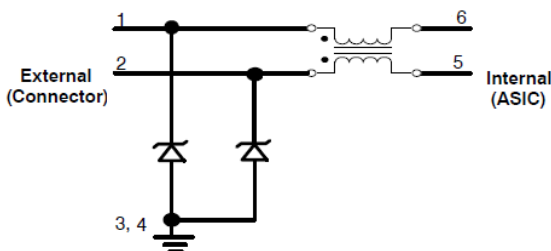
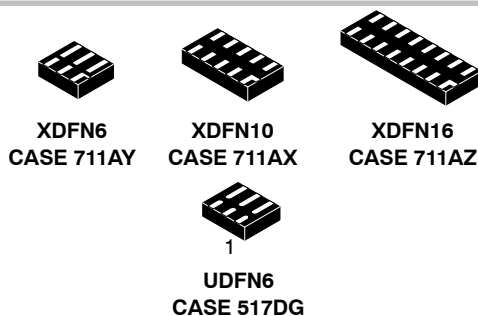
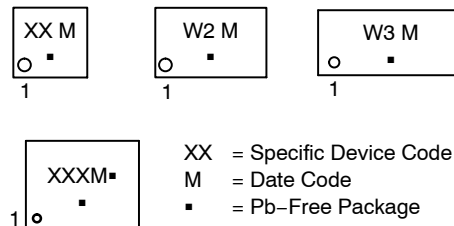

Figure 1. EMI8041 Electrical Schematic



MARKING DIAGRAMS



ELECTRICAL SCHEMATICS

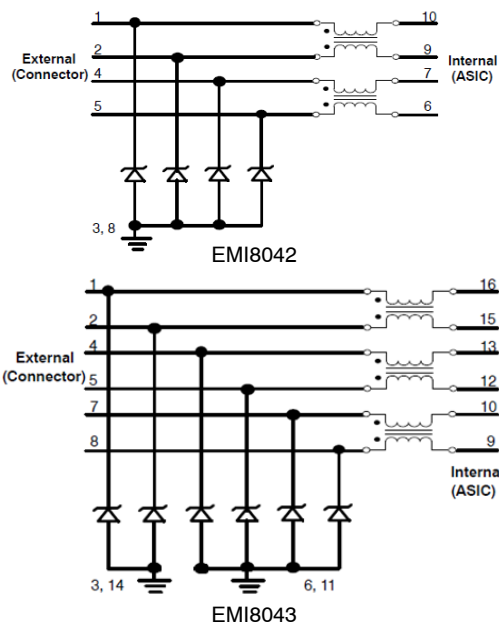

ORDERING INFORMATION

See detailed ordering and shipping information in the package dimensions section on page 6 of this data sheet.

EMI804x Series

PIN FUNCTION DESCRIPTION

Pin Name	Device Pin			Type	Description
	EMI8041	EMI8042	EMI8043		
In_1+	1	1	1	I/O	CMF Channel 1+ to Connector (External)
In_1-	2	2	2	I/O	CMF Channel 1- to Connector (External)
Out_1+	6	10	16	I/O	CMF Channel 1+ to ASIC (Internal)
Out_1-	5	9	15	I/O	CMF Channel 1- to ASIC (Internal)
In_2+	NA	4	4	I/O	CMF Channel 2+ to Connector (External)
In_2-	NA	5	5	I/O	CMF Channel 2- to Connector (External)
Out_2+	NA	7	13	I/O	CMF Channel 2+ to ASIC (Internal)
Out_2-	NA	6	12	I/O	CMF Channel 2- to ASIC (Internal)
In_3+	NA	NA	7	I/O	CMF Channel 3+ to Connector (External)
In_3-	NA	NA	8	I/O	CMF Channel 3- to Connector (External)
Out_3+	NA	NA	10	I/O	CMF Channel 3+ to ASIC (Internal)
Out_3-	NA	NA	9	I/O	CMF Channel 3- to ASIC (Internal)
VN	3,4	3, 8	3,6,14,11	GND	Ground

ABSOLUTE MAXIMUM RATINGS ($T_A = 25^\circ\text{C}$ unless otherwise noted)

Parameter	Symbol	Value	Unit
Operating Temperature Range	T_{OP}	-40 to +85	$^\circ\text{C}$
Storage Temperature Range	T_{STG}	-65 to +150	$^\circ\text{C}$
Maximum Lead Temperature for Soldering Purposes (1/8" from Case for 10 seconds)	T_L	260	$^\circ\text{C}$
DC Current per Line	I_{LINE}	100	mA

Stresses exceeding those listed in the Maximum Ratings table may damage the device. If any of these limits are exceeded, device functionality should not be assumed, damage may occur and reliability may be affected.

EMI804x Series

ELECTRICAL CHARACTERISTICS ($T_A = 25^\circ\text{C}$ unless otherwise noted)

Symbol	Parameter	Test Conditions	Min	Typ	Max	Unit
V_{RWM}	Reverse Working Voltage	(Note 3)		3.3		V
V_{BR}	Breakdown Voltage	$I_T = 1 \text{ mA}$; (Note 4)	4.0		9.0	V
I_{LEAK}	Channel Leakage Current	$T_A = 25^\circ\text{C}$, $V_{IN} = 3.3 \text{ V}$, $\text{GND} = 0 \text{ V}$			1.0	μA
R_{CH}	Channel Resistance (Pins 1–6, 2–5) – EMI8041 (Pins 1–10, 2–9, 4–7 and 5–6) – EMI8042 (Pins 1–16, 2–15, 4–13, 5–12, 7–10 and 8–9) – EMI8043			6.0		Ω
DM_{LOSS}	Differential Mode Insertion Loss	@ 2.5 GHz		2.5		dB
f_{3dB}	Differential Mode Cut-off Frequency	50 Ω Source and Load Termination		5.0		GHz
F_{atten}	Common Mode Stop Band Attenuation	@ 700 MHz		15		dB
V_{ESD}	In-system ESD Withstand Voltage a) Contact discharge per IEC 61000-4-2 standard, Level 4 (External Pins) b) Contact discharge per IEC 61000-4-2 standard, Level 1 (Internal Pins)	(Notes 1 and 2)	± 15 ± 2			kV
V_{CL}	TLP Clamping Voltage	Forward $I_{PP} = 8 \text{ A}$ Forward $I_{PP} = 16 \text{ A}$ Forward $I_{PP} = -8 \text{ A}$ Forward $I_{PP} = -16 \text{ A}$		7.26 11.8 -3.5 -6.7		V

Product parametric performance is indicated in the Electrical Characteristics for the listed test conditions, unless otherwise noted. Product performance may not be indicated by the Electrical Characteristics if operated under different conditions.

1. Standard IEC61000-4-2 with $C_{Discharge} = 150 \text{ pF}$, $R_{Discharge} = 330$, GND grounded.
2. These measurements performed with no external capacitor.
3. TVS devices are normally selected according to the working peak reverse voltage (V_{RWM}), which should be equal to or greater than the DC or continuous peak operating voltage level.
4. V_{BR} is measured at pulse test current I_T .

EMI804x Series

TYPICAL CHARACTERISTICS

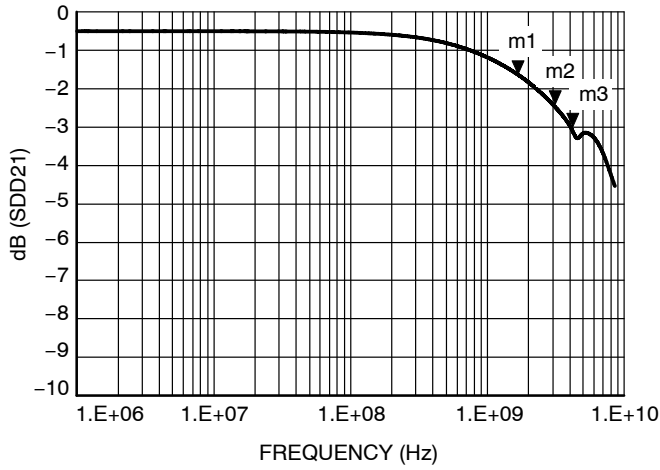

Figure 2. Typical Differential Mode Attenuation vs. Frequency

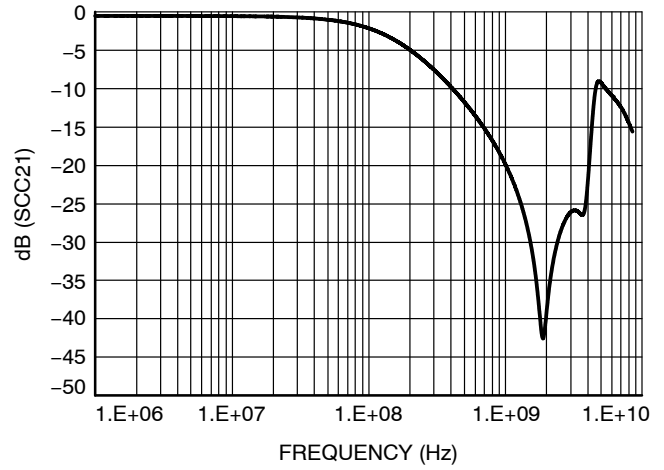

Figure 3. Typical Common Mode Attenuation vs. Frequency

Interface	Data Rate (Gb/s)	Fundamental Frequency (GHz)	EMI804x Insertion Loss (dB)
HDMI 1.3/1.4	3.4	1.7 (m1)	m1 = 1.65
USB 3.0	5.0	2.5 (m2)	m2 = 2.13
HDMI 2.0	6.0	3.0 (m3)	m3 = 2.41

EMI804x Series

TRANSMISSION LINE PULSE (TLP) MEASUREMENTS

Transmission Line Pulse (TLP) provides current versus voltage (I-V) curves in which each data point is obtained from a 100 ns long rectangular pulse from a charged transmission line. A simplified schematic of a typical TLP system is shown in Figure 4. TLP I-V curves of ESD protection devices accurately demonstrate the product's ESD capability because the 10 s of amps current levels and under 100 ns time scale match those of an ESD event. This is illustrated in Figure 5 where an 8 kV IEC61000-4-2 current waveform is compared with TLP current pulses at 8 A and 16 A. A TLP curve shows the voltage at which the device turns on as well as how well the device clamps voltage over a range of current levels. Typical TLP I-V curves for the EMI804x are shown in Figure 4.

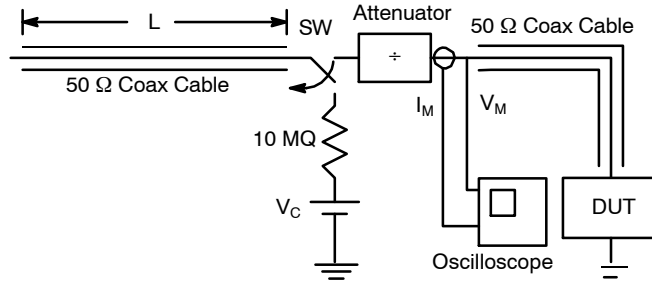

Figure 4. Simplified Schematic of a Typical TLP System

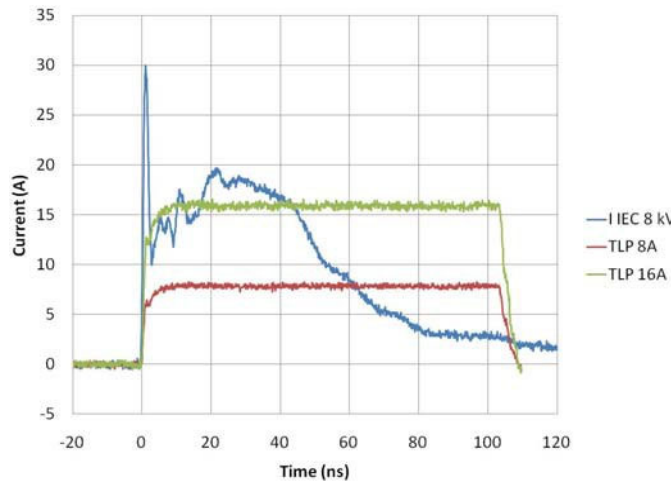

Figure 5. Comparison Between 8 kV IEC61000-4-2 and 8 A and 16 A TLP Waveforms

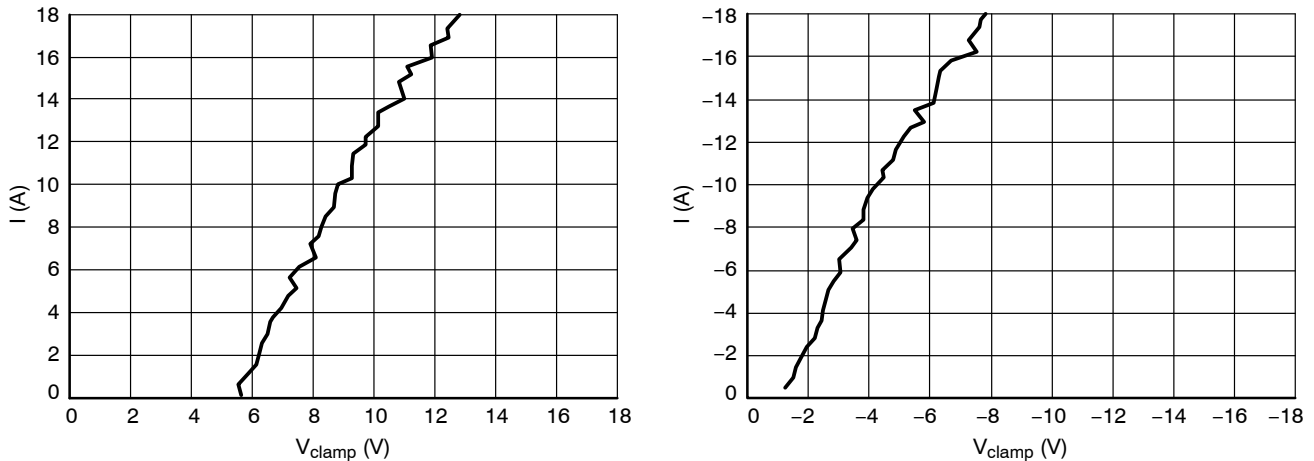

Figure 6. Positive and Negative TLP Waveforms

EMI804x Series

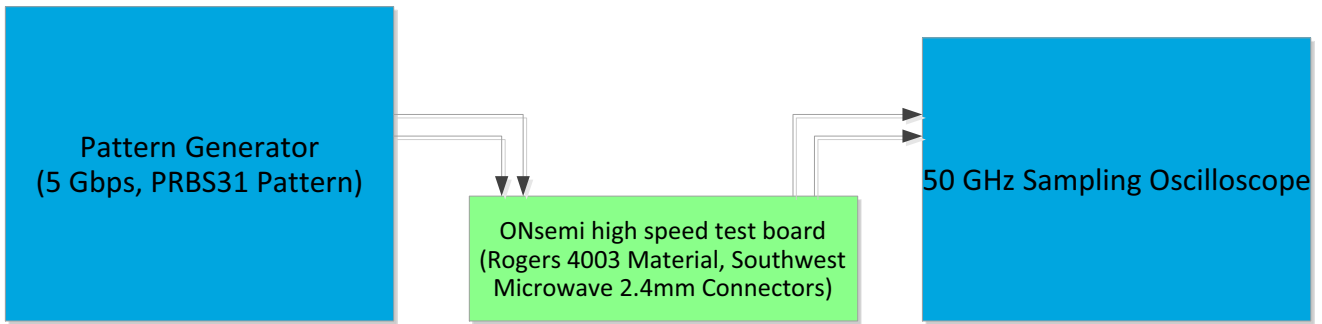

Figure 7. Eye Diagram Test Setup for 5Gbps Data Rate

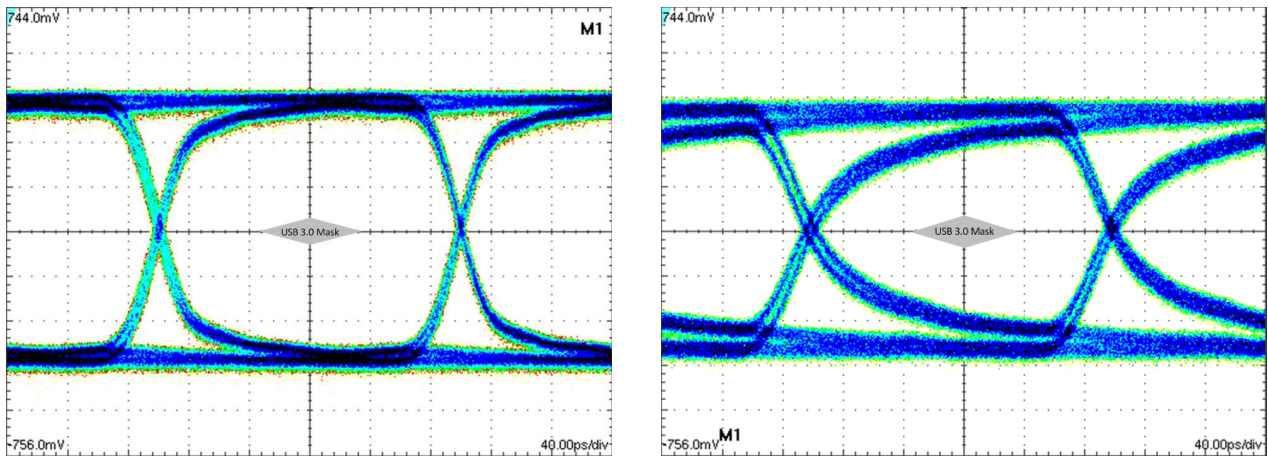

Figure 8. Eye Diagram 5Gbps with and without EMI804x

	Eye Height (mVppd)	Rise Time (ps)	Fall Time (ps)	Jrms (ps)	Jpp (ps)
Reference (No Device)-Left Figure	724	30.4	29.6	1.997	9.6
EMI804x Right Figure	405	60	60.8	3.484	16

ORDERING INFORMATION

Orderable Part Number	Marking	Package	Shipping [†]
EMI8041MUTAG, SZEMI8041MUTAG*	WA	XDFN6 (Pb-Free)	3000 / Tape & Reel
EMI8042MUTAG, SZEMI8042MUTAG*	W2	XDFN10 (Pb-Free)	3000 / Tape & Reel
EMI8043MUTAG, SZEMI8043MUTAG*	W3	XDFN16 (Pb-Free)	3000 / Tape & Reel
EMI8041BMUTAG	MA	UDFN6 (Pb-Free)	3000 / Tape & Reel

[†]For information on tape and reel specifications, including part orientation and tape sizes, please refer to our Tape and Reel Packaging Specifications Brochure, BRD8011/D.

*SZ Prefix for Automotive and Other Applications Requiring Unique Site and Control Change Requirements; AEC-Q101 Qualified and PPAP Capable.

MECHANICAL CASE OUTLINE

PACKAGE DIMENSIONS

ON Semiconductor®



SCALE 4:1

UDFN6 1.6x1.35, 0.5P
CASE 517DG
ISSUE O

DATE 21 SEP 2015

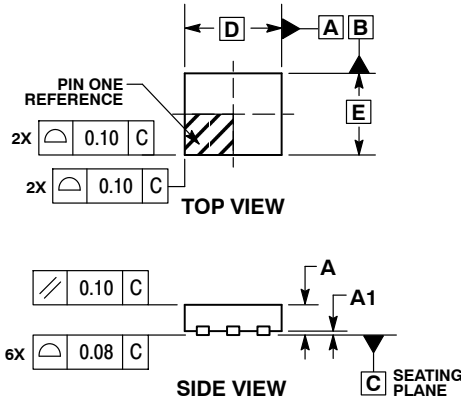

DETAIL A

NOTES:

1. DIMENSIONING AND TOLERANCING PER ASME Y14.5M, 1994.
2. CONTROLLING DIMENSION: MILLIMETERS.
3. DIMENSION b APPLIES TO PLATED TERMINAL AND IS MEASURED BETWEEN 0.15 AND 0.30 mm FROM THE TERMINAL TIP.

MILLIMETERS		
DIM	MIN	MAX
A	0.45	0.55
A1	0.00	0.05
b	0.15	0.25
D	1.60	BSC
E	1.35	BSC
e	0.50	BSC
L	0.35	0.55
L2	0.65	0.85

GENERIC MARKING DIAGRAM*

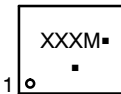

- XXX = Specific Device Code
- M = Date Code
- = Pb-Free Package

(Note: Microdot may be in either location)
*This information is generic. Please refer to device data sheet for actual part marking.
Pb-Free indicator, "G" or microdot "▪", may or may not be present.

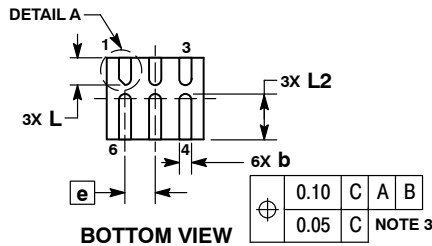

RECOMMENDED MOUNTING FOOTPRINT

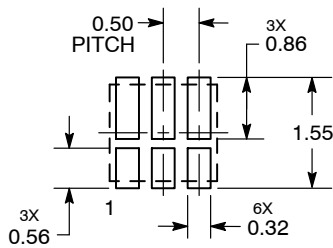

DIMENSIONS: MILLIMETERS

*For additional information on our Pb-Free strategy and soldering details, please download the ON Semiconductor Soldering and Mounting Techniques Reference Manual, SOLDERRM/D.

DOCUMENT NUMBER:	98AON05041G	Electronic versions are uncontrolled except when accessed directly from the Document Repository. Printed versions are uncontrolled except when stamped "CONTROLLED COPY" in red.
DESCRIPTION:	UDFN6, 1.6X1.35, 0.5P	PAGE 1 OF 1

ON Semiconductor and ON are trademarks of Semiconductor Components Industries, LLC dba ON Semiconductor or its subsidiaries in the United States and/or other countries. ON Semiconductor reserves the right to make changes without further notice to any products herein. ON Semiconductor makes no warranty, representation or guarantee regarding the suitability of its products for any particular purpose, nor does ON Semiconductor assume any liability arising out of the application or use of any product or circuit, and specifically disclaims any and all liability, including without limitation special, consequential or incidental damages. ON Semiconductor does not convey any license under its patent rights nor the rights of others.

MECHANICAL CASE OUTLINE

PACKAGE DIMENSIONS

ON Semiconductor®



SCALE 4:1

XDFN10 2.50x1.35, 0.5P
CASE 711AX
ISSUE A

DATE 12 APR 2016

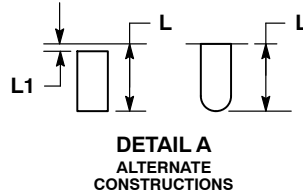
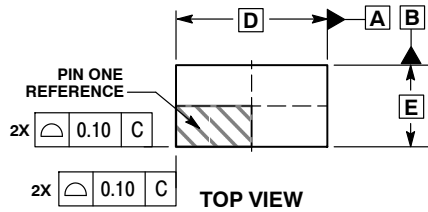

- NOTES:
1. DIMENSIONING AND TOLERANCING PER ASME Y14.5M, 1994.
 2. CONTROLLING DIMENSION: MILLIMETERS.
 3. DIMENSIONS b APPLIES TO PLATED TERMINAL AND IS MEASURED BETWEEN 0.15 AND 0.30 MM FROM THE TERMINAL TIP.

DIM	MILLIMETERS	
	MIN	MAX
A	0.40	0.50
A1	0.00	0.05
A3	0.15 REF	
b	0.15	0.25
D	2.50 BSC	
E	1.35 BSC	
e	0.50 BSC	
L	0.40	0.60
L1	---	0.15

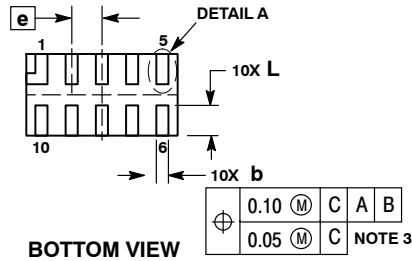
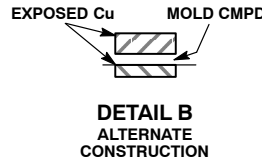
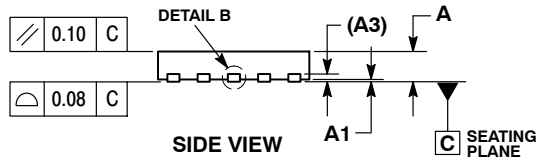

GENERIC MARKING DIAGRAM*

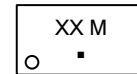

- XX = Specific Device Code
- M = Date Code
- = Pb-Free Package

*This information is generic. Please refer to device data sheet for actual part marking. Pb-Free indicator, "G" or microdot "▪", may or may not be present.

RECOMMENDED MOUNTING FOOTPRINT

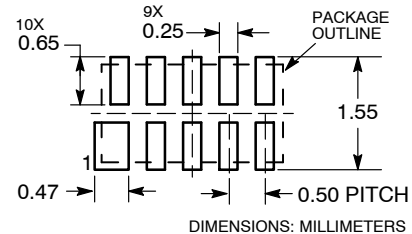

DOCUMENT NUMBER:	98AON90283F	Electronic versions are uncontrolled except when accessed directly from the Document Repository. Printed versions are uncontrolled except when stamped "CONTROLLED COPY" in red.
DESCRIPTION:	XDFN10 2.50X1.35, 0.5P	PAGE 1 OF 1

ON Semiconductor and are trademarks of Semiconductor Components Industries, LLC dba ON Semiconductor or its subsidiaries in the United States and/or other countries. ON Semiconductor reserves the right to make changes without further notice to any products herein. ON Semiconductor makes no warranty, representation or guarantee regarding the suitability of its products for any particular purpose, nor does ON Semiconductor assume any liability arising out of the application or use of any product or circuit, and specifically disclaims any and all liability, including without limitation special, consequential or incidental damages. ON Semiconductor does not convey any license under its patent rights nor the rights of others.

MECHANICAL CASE OUTLINE

PACKAGE DIMENSIONS

ON Semiconductor®



SCALE 4:1

XDFN6 1.50x1.35, 0.5P
CASE 711AY
ISSUE O

DATE 09 SEP 2014

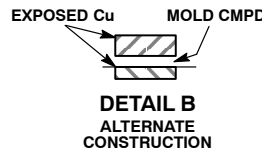
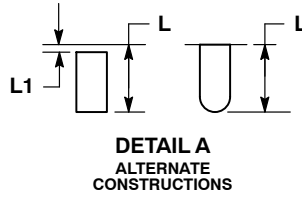
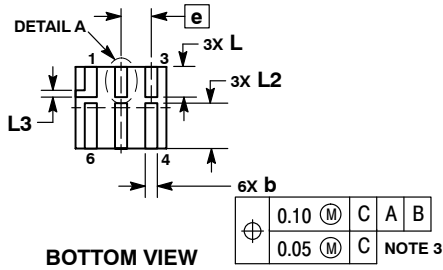
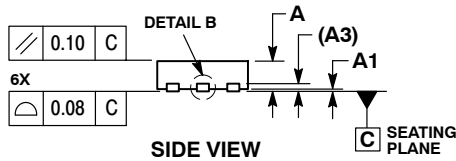
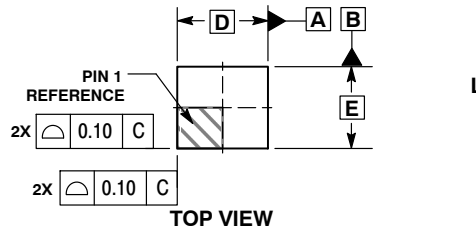

NOTES:

1. DIMENSIONING AND TOLERANCING PER ASME Y14.5M, 1994.
2. CONTROLLING DIMENSION: MILLIMETERS.
3. DIMENSIONS b APPLIES TO PLATED TERMINAL AND IS MEASURED BETWEEN 0.15 AND 0.30 MM FROM TERMINAL TIP.

DIM	MILLIMETERS	
	MIN	MAX
A	0.40	0.50
A1	0.00	0.05
A3	0.15 REF	
b	0.15	0.25
D	1.50 BSC	
E	1.35 BSC	
e	0.50 BSC	
L	0.35	0.55
L1	-	0.15
L2	0.65	0.85
L3	0.15 REF	

GENERIC MARKING DIAGRAM*

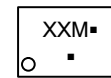

- XX = Specific Device Code
- M = Date Code
- = Pb-Free Package

(Note: Microdot may be in either location)

*This information is generic. Please refer to device data sheet for actual part marking. Pb-Free indicator, "G" or microdot "▪", may or may not be present.

RECOMMENDED MOUNTING FOOTPRINT

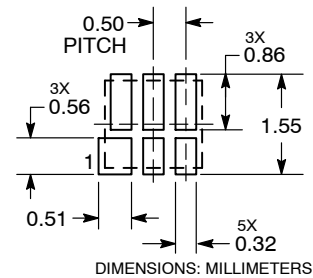

DOCUMENT NUMBER:	98AON90322F	Electronic versions are uncontrolled except when accessed directly from the Document Repository. Printed versions are uncontrolled except when stamped "CONTROLLED COPY" in red.
DESCRIPTION:	XDFN6 1.50X1.35, 0.5P	PAGE 1 OF 1

ON Semiconductor and ON are trademarks of Semiconductor Components Industries, LLC dba ON Semiconductor or its subsidiaries in the United States and/or other countries. ON Semiconductor reserves the right to make changes without further notice to any products herein. ON Semiconductor makes no warranty, representation or guarantee regarding the suitability of its products for any particular purpose, nor does ON Semiconductor assume any liability arising out of the application or use of any product or circuit, and specifically disclaims any and all liability, including without limitation special, consequential or incidental damages. ON Semiconductor does not convey any license under its patent rights nor the rights of others.

MECHANICAL CASE OUTLINE

PACKAGE DIMENSIONS

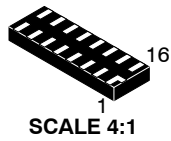

XDFN16 4.0x1.35, 0.5P
CASE 711AZ
ISSUE 0

DATE 09 SEP 2014

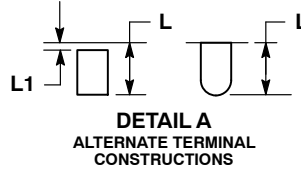
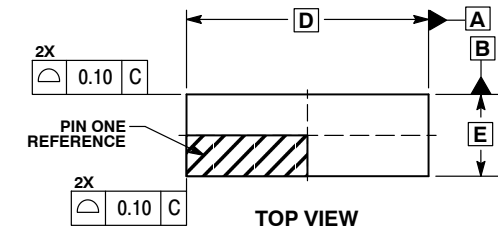

- NOTES:
1. DIMENSIONING AND TOLERANCING PER ASME Y14.5M, 1994.
 2. CONTROLLING DIMENSION: MILLIMETERS.
 3. DIMENSION b APPLIES TO PLATED TERMINAL AND IS MEASURED BETWEEN 0.15 AND 0.30 mm FROM THE TERMINAL TIP.

MILLIMETERS		
DIM	MIN	MAX
A	0.40	0.50
A1	0.00	0.05
A3	0.15 REF	
b	0.15	0.25
D	4.00 BSC	
E	1.35 BSC	
e	0.50 BSC	
L	0.40	0.60
L1	---	0.15
L2	0.20 REF	

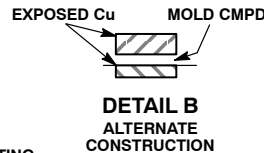
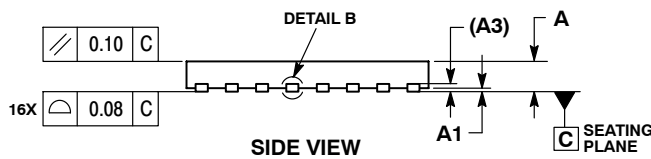

GENERIC MARKING DIAGRAM*

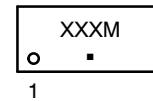

- XXX = Specific Device Code
- M = Month Code
- = Pb-Free Package

*This information is generic. Please refer to device data sheet for actual part marking. Pb-Free indicator, "G" or microdot "▪", may or may not be present.

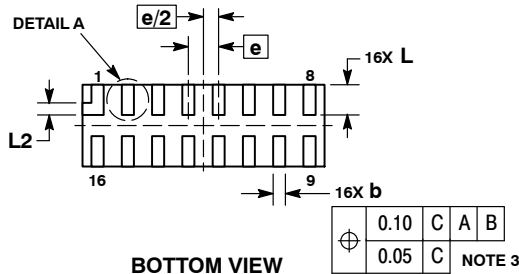

RECOMMENDED SOLDERING FOOTPRINT*

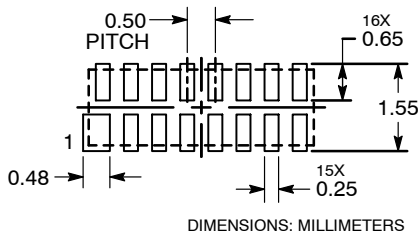

*For additional information on our Pb-Free strategy and soldering details, please download the ON Semiconductor Soldering and Mounting Techniques Reference Manual, SOLDERRM/D.

DOCUMENT NUMBER:	98AON90324F	Electronic versions are uncontrolled except when accessed directly from the Document Repository. Printed versions are uncontrolled except when stamped "CONTROLLED COPY" in red.
DESCRIPTION:	XDFN16 4.0X1.35, 0.5P	PAGE 1 OF 1

ON Semiconductor and ON are trademarks of Semiconductor Components Industries, LLC dba ON Semiconductor or its subsidiaries in the United States and/or other countries. ON Semiconductor reserves the right to make changes without further notice to any products herein. ON Semiconductor makes no warranty, representation or guarantee regarding the suitability of its products for any particular purpose, nor does ON Semiconductor assume any liability arising out of the application or use of any product or circuit, and specifically disclaims any and all liability, including without limitation special, consequential or incidental damages. ON Semiconductor does not convey any license under its patent rights nor the rights of others.

ON Semiconductor and  are trademarks of Semiconductor Components Industries, LLC dba ON Semiconductor or its subsidiaries in the United States and/or other countries. ON Semiconductor owns the rights to a number of patents, trademarks, copyrights, trade secrets, and other intellectual property. A listing of ON Semiconductor's product/patent coverage may be accessed at www.onsemi.com/site/pdf/Patent-Marking.pdf. ON Semiconductor reserves the right to make changes without further notice to any products herein. ON Semiconductor makes no warranty, representation or guarantee regarding the suitability of its products for any particular purpose, nor does ON Semiconductor assume any liability arising out of the application or use of any product or circuit, and specifically disclaims any and all liability, including without limitation special, consequential or incidental damages. Buyer is responsible for its products and applications using ON Semiconductor products, including compliance with all laws, regulations and safety requirements or standards, regardless of any support or applications information provided by ON Semiconductor. "Typical" parameters which may be provided in ON Semiconductor data sheets and/or specifications can and do vary in different applications and actual performance may vary over time. All operating parameters, including "Typicals" must be validated for each customer application by customer's technical experts. ON Semiconductor does not convey any license under its patent rights nor the rights of others. ON Semiconductor products are not designed, intended, or authorized for use as a critical component in life support systems or any FDA Class 3 medical devices or medical devices with a same or similar classification in a foreign jurisdiction or any devices intended for implantation in the human body. Should Buyer purchase or use ON Semiconductor products for any such unintended or unauthorized application, Buyer shall indemnify and hold ON Semiconductor and its officers, employees, subsidiaries, affiliates, and distributors harmless against all claims, costs, damages, and expenses, and reasonable attorney fees arising out of, directly or indirectly, any claim of personal injury or death associated with such unintended or unauthorized use, even if such claim alleges that ON Semiconductor was negligent regarding the design or manufacture of the part. ON Semiconductor is an Equal Opportunity/Affirmative Action Employer. This literature is subject to all applicable copyright laws and is not for resale in any manner.

PUBLICATION ORDERING INFORMATION

LITERATURE FULFILLMENT:

Email Requests to: orderlit@onsemi.com

ON Semiconductor Website: www.onsemi.com

TECHNICAL SUPPORT

North American Technical Support:
Voice Mail: 1 800-282-9855 Toll Free USA/Canada
Phone: 011 421 33 790 2910

Europe, Middle East and Africa Technical Support:

Phone: 00421 33 790 2910

For additional information, please contact your local Sales Representative

Mouser Electronics

Authorized Distributor

Click to View Pricing, Inventory, Delivery & Lifecycle Information:

[ON Semiconductor:](#)

[EMI8042MUTAG](#) [EMI8041MUTAG](#) [EMI8043MUTAG](#) [EMI8041BMUTAG](#)