

---

## VFM STEP-UP DC/DC CONVERTER

---

NO.EA-045-181012

### OUTLINE

The RN5RKxx1A/xx1B/xx2A Series are CMOS-based VFM (Chopper) Step-up DC/DC converter ICs with ultra low supply current and high output voltage accuracy.

Each of the RN5RKxx1A/xx1B consists of an oscillator, a VFM control circuit, a driver transistor to have low ON resistance (Lx switch), a reference voltage unit, a high speed comparator, resistors for voltage detection, an Lx switch protection circuit and an internal chip enable circuit. A low ripple, high efficiency step-up DC/DC converter can be composed of this RN5RKxx1A/xx1B with only three external components: an inductor, a diode and a capacitor.

The RN5RKxx2A uses the same chip as what is employed in the RN5RKxx1A/1B IC and has a drive pin (EXT) for an external transistor instead of an Lx pin. As it is possible to load a large output current with a power transistor which has a low saturation voltage, RN5RKxx2A IC is recommendable to users who need an output current as large as between several tens mA and several hundreds mA.

Using the chip enable function, it is possible to make the supply current on standby minimized.

Since the package for these ICs is SOT-23-5, high density mounting of the ICs on board is possible.

### FEATURES

- Small Number of External Components ..... Only an inductor, a diode and a capacitor (RN5RKxx1A/xx1B)
- Standby Current ..... Typ. 0 $\mu$ A
- Low Temperature-Drift Coefficient of Output Voltage..... Typ.  $\pm$ 100ppm/ $^{\circ}$ C
- Output Voltage Range..... 2.0V to 5.5V
- Two Kinds of Duty Ratio..... 77% (xx1A, xx2A)/ 55% (xx1B)
- High Output Voltage Accuracy .....  $\pm$ 2.5%
- Small Packages ..... SOT-23-5
- High Efficiency ..... Typ. 85% (RN5RK301B,  $V_{IN}$ =2V,  $I_{OUT}$ =10mA)
- Low Ripple and Low Noise
- Including a Driver Transistor with Low ON Resistance..... Only RN5RKxx1A/xx1B
- Low Start-up Voltage..... Max.0.9V

### APPLICATIONS

- Power source for battery-powered equipment.
- Power source for cameras, camcorders, VCRs, and hand-held communication equipment.
- Power source for those appliances which require higher cell voltage than that of batteries.

**OUTLINE DIAGRAM**

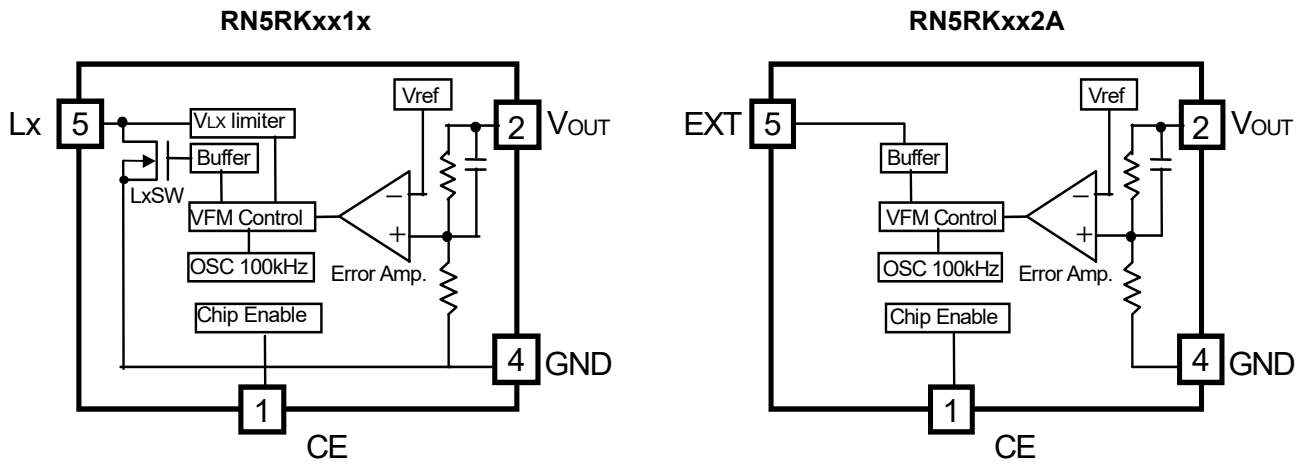

**SELECTION GUIDE**

The output voltage, the driver type and the duty cycle for the ICs can be selected at the user's request.

Product Name	Package	Quantity per Reel	Pb Free	Halogen Free
RN5RKxx* $\$$ -TR-FE	SOT-23-5	3,000 pcs	○	○
xx : The output voltage can be designed in the range from 2.0V(20) to 5.5V(55) in 0.1V steps.				
* : Designation of Driver (1) Internal Lx Tr. Driver (2) External Tr. Driver				
$\$$ : Designation of Duty Cycle (A) 77% (B) 55%				

## PIN CONFIGURATIONS

- SOT-23-5

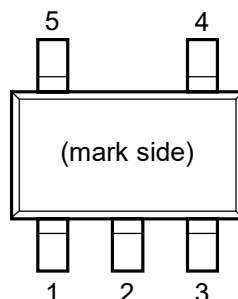

## PIN DISCIPTION

- RN5RKxx1x

Pin No.	Symbol	Description
1	CE	Chip Enable Pin
2	V <sub>OUT</sub>	Step-up Output Monitoring Pin, Power Supply (for device itself)
3	NC	No Connection
4	GND	Ground Pin
5	L <sub>x</sub>	Switching Pin (Nch Open Drain)

- RN5RKxx2A

Pin No.	Symbol	Description
1	CE	Chip Enable Pin
2	V <sub>OUT</sub>	Step-up Output Monitoring Pin, Power Supply (for device itself)
3	NC	No Connection
4	GND	Ground Pin
5	EXT	External Tr. Drive Pin (CMOS Output)

**RN5RK**

NO.EA-045-181012

**ABSOLUTE MAXIMUM RATINGS**● **RN5RKxx1x**

Symbol	Item	Rating	Unit
$V_{OUT}$	Step-up Output Pin Voltage	-0.3 to 9.0	V
$V_{LX}$	Lx Pin Voltage	-0.3 to 9.0	V
$V_{CE}$	CE Pin Voltage	-0.3 to $V_{OUT}+0.3$	V
$I_{LX}$	Lx Pin Output Current	500	mA
$P_D$	Power Dissipation (SOT-23-5)*	420	mW
$T_{opt}$	Operating Temperature Range	-40 to 85	°C
$T_{stg}$	Storage Temperature Range	-55 to 125	°C

● **RN5RKxx2A**

Symbol	Item	Rating	Unit
$V_{OUT}$	Step-up Output Pin Voltage	-0.3 to 9.0	V
$V_{EXT}$	EXT Pin Voltage	-0.3 to $V_{OUT}+0.3$	V
$V_{CE}$	CE Pin Voltage	-0.3 to $V_{OUT}+0.3$	V
$I_{EXT}$	EXT Pin Output Current	$\pm 30$	mA
$P_D$	Power Dissipation (SOT-23-5)* <sup>1</sup>	420	mW
$T_{opt}$	Operating Temperature Range	-40 to 85	°C
$T_{stg}$	Storage Temperature Range	-55 to 125	°C

\*)For Power Dissipation, please refer to PACKAGE INFORMATION.

**ABSOLUTE MAXIMUM RATINGS**

Electronic and mechanical stress momentarily exceeded absolute maximum ratings may cause the permanent damages and may degrade the life time and safety for both device and system using the device in the field.

The functional operation at or over these absolute maximum ratings is not assured.

## ELECTRICAL CHARACTERISTICS

## • RN5RKxx1A/xx1B

T<sub>opt</sub>=25°C

Symbol	Item	Conditions	Min.	Typ.	Max.	Unit
V <sub>OUT</sub>	Output Voltage	V <sub>IN</sub> =Set V <sub>OUT</sub> ×0.6, I <sub>OUT</sub> =1mA	×0.975		×1.025	V
V <sub>IN</sub>	Input Voltage				8.0	V
$\frac{\Delta V_{OUT}}{\Delta T_{opt}}$	Output Voltage Temperature Coefficient	-40°C ≤ T <sub>opt</sub> ≤ 85°C		±100		ppm/°C
V <sub>start</sub>	Start-Up Voltage	V <sub>IN</sub> =0V→2V*1		0.75	0.90	V
$\frac{\Delta V_{start}}{\Delta T_{opt}}$	Start-Up Voltage Temperature Coefficient	-40°C ≤ T <sub>opt</sub> ≤ 85°C V <sub>IN</sub> =0V→2V*1		-1.6		mV/°C
V <sub>hold</sub>	Hold-on Voltage (xx1A)	V <sub>IN</sub> =2V→0V*1	0.7			V
V <sub>hold</sub>	Hold-on Voltage (xx1B)	V <sub>IN</sub> =2V→0V*1	0.9			V
I <sub>DD2</sub>	Supply Current2	V <sub>OUT</sub> =V <sub>CE</sub> =Set V <sub>OUT</sub> +0.5V		2	5	μA
I <sub>standby</sub>	Standby Current	V <sub>OUT</sub> =6V, V <sub>CE</sub> =0V			0.5	μA
I <sub>LXleak</sub>	Lx Leakage Current	V <sub>OUT</sub> =V <sub>LX</sub> =8V			1	μA
f <sub>osc</sub>	Maximum Oscillator Frequency	V <sub>OUT</sub> =V <sub>CE</sub> =Set V <sub>OUT</sub> ×0.96	80	100	120	kHz
$\frac{\Delta f_{osc}}{\Delta T_{opt}}$	Frequency Temperature Coefficient	-40°C ≤ T <sub>opt</sub> ≤ 85°C		0.41		kHz/°C
Maxduty	Oscillator Duty Cycle (xx1A)	V <sub>OUT</sub> =V <sub>CE</sub> =Set V <sub>OUT</sub> ×0.96, ON (V <sub>LX</sub> "L" side)	70	77	85	%
	Oscillator Duty Cycle (xx1B)		47	55	63	%
V <sub>LXlim</sub>	V <sub>LX</sub> Voltage Limit	V <sub>OUT</sub> =V <sub>CE</sub> =1.95V, Lx Switch ON	0.4	0.6	0.8	V
V <sub>CEH</sub>	CE "H" Input Voltage	V <sub>OUT</sub> =V <sub>CE</sub> =Set V <sub>OUT</sub> ×0.96, Judgment is made by the Lx waveform	0.9			V
V <sub>CEL</sub>	CE "L" Input Voltage				0.3	V
I <sub>CEH</sub>	CE "H" Input Current	V <sub>OUT</sub> =6.0V, V <sub>CE</sub> =6.0V	-0.5	0	0.5	μA
I <sub>CEL</sub>	CE "L" Input Current	V <sub>OUT</sub> =6.0V, V <sub>CE</sub> =0V	-0.5	0	0.5	μA
I <sub>DD1</sub>	Supply Current1 *2	2.0V ≤ Set V <sub>OUT</sub> ≤ 2.4V		25	50	μA
		2.5V ≤ Set V <sub>OUT</sub> ≤ 2.9V		30	55	
		3.0V ≤ Set V <sub>OUT</sub> ≤ 3.4V		35	60	
		3.5V ≤ Set V <sub>OUT</sub> ≤ 3.9V		40	65	
		4.0V ≤ Set V <sub>OUT</sub> ≤ 4.4V		45	75	
		4.5V ≤ Set V <sub>OUT</sub> ≤ 4.9V		50	80	
		5.0V ≤ Set V <sub>OUT</sub> ≤ 5.5V		55	90	

**RN5RK**

NO.EA-045-181012

Symbol	Item	Conditions	Min.	Typ.	Max.	Unit
I <sub>LX</sub>	Lx Switching Current	$2.0V \leq \text{Set } V_{\text{OUT}} \leq 2.4V, V_{\text{LX}}=0.4V$	80			mA
		$2.5V \leq \text{Set } V_{\text{OUT}} \leq 2.9V, V_{\text{LX}}=0.4V$	100			
		$3.0V \leq \text{Set } V_{\text{OUT}} \leq 3.4V, V_{\text{LX}}=0.4V$	120			
		$3.5V \leq \text{Set } V_{\text{OUT}} \leq 3.9V, V_{\text{LX}}=0.4V$	140			
		$4.0V \leq \text{Set } V_{\text{OUT}} \leq 4.4V, V_{\text{LX}}=0.4V$	160			
		$4.5V \leq \text{Set } V_{\text{OUT}} \leq 4.9V, V_{\text{LX}}=0.4V$	180			
		$5.0V \leq \text{Set } V_{\text{OUT}} \leq 5.5V, V_{\text{LX}}=0.4V$	200			

\*1)Condition: An Output load resistor R<sub>L</sub> is connected between V<sub>OUT</sub> and GND.

Note that the resistor R<sub>L</sub> has a resistance which makes an output current 1mA after step-up operation.

\*2)The Supply Current I (I<sub>DD1</sub>) for IC itself is measured when the internal oscillator works continuously.

If the oscillator works intermittently, the supply current becomes smaller than the value which is written on the above table.

#### RECOMMENDED OPERATING CONDITIONS (ELECTRICAL CHARACTERISTICS)

All of electronic equipment should be designed that the mounted semiconductor devices operate within the recommended operating conditions. The semiconductor devices cannot operate normally over the recommended operating conditions, even if when they are used over such conditions by momentary electronic noise or surge. And the semiconductor devices may receive serious damage when they continue to operate over the recommended operating conditions.

## ● RN5RKxx2A

T<sub>opt</sub>=25°C

Symbol	Item	Conditions	Min.	Typ.	Max.	Unit
V <sub>OUT</sub>	Output Voltage	V <sub>OUT</sub> =V <sub>CE</sub> =0V→6V, Judgment is made by the EXT waveform	×0.975		×1.025	V
V <sub>IN</sub>	Input Voltage				8.0	V
ΔV <sub>OUT</sub> / ΔT <sub>opt</sub>	Output Voltage Temperature Coefficient	-40°C ≤ T <sub>opt</sub> ≤ 85°C		±100		ppm /°C
V <sub>start</sub>	Start-Up Voltage	V <sub>OUT</sub> =V <sub>CE</sub> =0V→2V		0.7	0.8	V
I <sub>DD2</sub>	Supply Current2	V <sub>OUT</sub> =V <sub>CE</sub> =Set V <sub>OUT</sub> +0.5V		2	5	μA
I <sub>standby</sub>	Standby Current	V <sub>OUT</sub> =6V, V <sub>CE</sub> =0V			0.5	μA
f <sub>osc</sub>	Maximum Oscillator Frequency	V <sub>OUT</sub> =V <sub>CE</sub> =Set V <sub>OUT</sub> ×0.96	80	100	120	kHz
Δf <sub>osc</sub> / ΔT <sub>opt</sub>	Frequency Temperature Coefficient	-40°C ≤ T <sub>opt</sub> ≤ 85°C		0.41		kHz /°C
Duty	Oscillator Duty Cycle	V <sub>OUT</sub> =V <sub>CE</sub> =Set V <sub>OUT</sub> ×0.96, ON (V <sub>LX</sub> "H" side)	70	77	85	%
V <sub>CEH</sub>	CE "H" Input Voltage	V <sub>OUT</sub> =V <sub>CE</sub> =Set V <sub>OUT</sub> ×0.96, Judgment is made by the EXT waveform	0.9			V
V <sub>CEL</sub>	CE "L" Input Voltage					0.3
I <sub>CEH</sub>	CE "H" Input Current	V <sub>OUT</sub> =6.0V, V <sub>CE</sub> =6.0V	-0.5	0	0.5	μA
I <sub>CEL</sub>	CE "L" Input Current	V <sub>OUT</sub> =6.0V, V <sub>CE</sub> =0V	-0.5	0	0.5	μA
I <sub>DD1</sub>	Supply Current1 *1	2.0V ≤ V <sub>OUT</sub> ≤ 2.9V, EXT no load		20	40	μA
		3.0V ≤ V <sub>OUT</sub> ≤ 3.9V, EXT no load		25	50	
		3.0V ≤ V <sub>OUT</sub> ≤ 3.4V, EXT no load		30	60	
		3.5V ≤ V <sub>OUT</sub> ≤ 3.9V, EXT no load		35	70	
I <sub>EXTH</sub>	EXT "H" Output Current	2.0V ≤ V <sub>OUT</sub> ≤ 2.4V, EXT no load			-1.0	mA
		2.5V ≤ V <sub>OUT</sub> ≤ 2.9V, EXT no load			-1.5	
		4.0V ≤ V <sub>OUT</sub> ≤ 5.5V, EXT no load			-2.0	
I <sub>EXTL</sub>	EXT "L" Output Current	2.0V ≤ V <sub>OUT</sub> ≤ 2.9V, EXT no load	1.0			
		3.0V ≤ V <sub>OUT</sub> ≤ 3.9V, EXT no load	1.5			
		4.0V ≤ V <sub>OUT</sub> ≤ 5.5V, EXT no load	2.0			

\*1) The Supply Current 1 (I<sub>DD1</sub>) for IC itself is measured when the internal oscillator works continuously.

If the oscillator works intermittently, the supply current becomes smaller than the value which is written on the above table.

#### RECOMMENDED OPERATING CONDITIONS (ELECTRICAL CHARACTERISTICS)

All of electronic equipment should be designed that the mounted semiconductor devices operate within the recommended operating conditions. The semiconductor devices cannot operate normally over the recommended operating conditions, even if when they are used over such conditions by momentary electronic noise or surge. And the semiconductor devices may receive serious damage when they continue to operate over the recommended operating conditions.

**TYPICAL APPLICATIONS AND TECHNICAL NOTES**

**RN5RKxx1x**

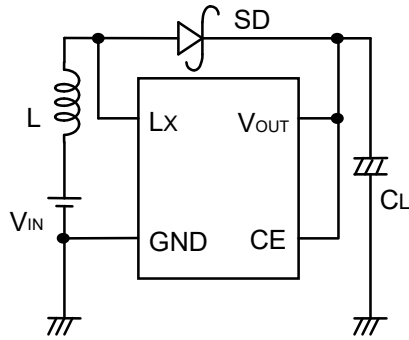

- L : 100 $\mu$ H (Sumida, CD54NP)
- SD : MA721 (Matsushita Electronics, Schottky Type)
- CL : 47 $\mu$ F (Tantalum Type)

**RN5RKxx2A**

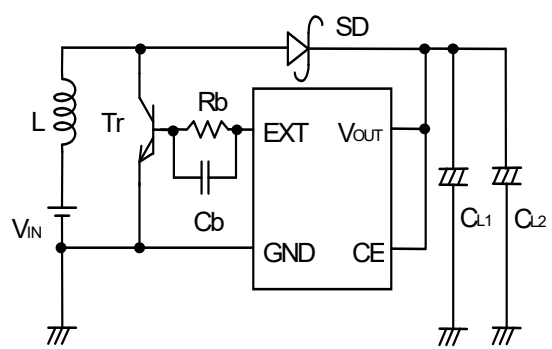

- L : 27 $\mu$ H (Sumida, CD105NP)
- SD : RB111C (Rohm, Schottky Type)
- CL1 : 47 $\mu$ F (Tantalum Type)
- CL2 : 47 $\mu$ F (Tantalum Type)
- Tr : 2SD1628G
- Rb : 300 $\Omega$
- Cb : 0.01 $\mu$ F

When you use these ICs, consider the following issues;

- Set external components as close as possible to the IC and minimize the connection between the components and the IC. In particular, a capacitor should be connected to V<sub>OUT</sub> pin with the minimum connection.
  - Make sufficient grounding. A large current flows through GND pin by switching. When the impedance of the GND connection is high, the potential within the IC is varied by the switching current. This may result in unstable operation of the IC.
  - Use capacitors with a capacity of 22 $\mu$ F or more, and with good high frequency characteristics such as tantalum capacitors.  
We recommend you to use output capacitors with an allowable voltage at least 3 times as much as setting output voltage. This is because there may be a case where a spike-shaped high voltage is generated by an inductor when an L<sub>x</sub> transistor is off.
  - Choose an inductor that has sufficiently small D.C. resistance and large allowable current and is hard to reach magnetic saturation.  
And if the value of inductance of an inductor is extremely small, the I<sub>Lx</sub> may exceed the absolute maximum rating at the maximum loading.  
Use an inductor with appropriate inductance.
  - Use a diode of a Schottky type with high switching speed, and also pay attention to its current capacity.
- \*The performance of power circuit with using this IC depends on external components. Choose the most suitable components for your application.



## TEST CIRCUITS

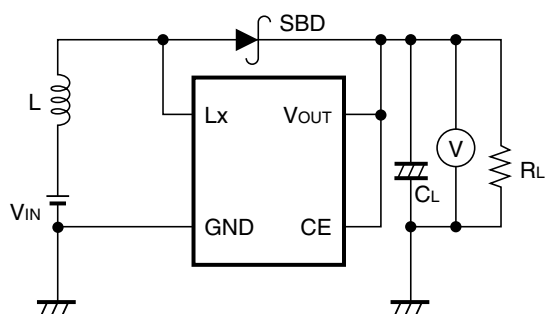

Test Circuit 1

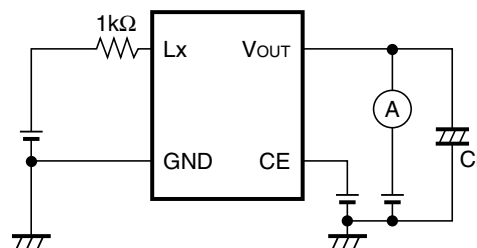

Test Circuit 2

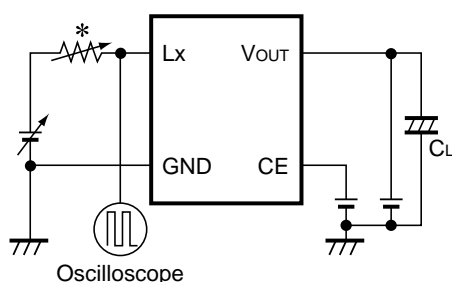

Test Circuit 3

\*)When  $V_{Lxlim}$  and  $I_{Lx}$  are measured, the  $5\Omega$  resistor is used. Otherwise  $1k\Omega$  is used.

Components Inductor (L) : 100 $\mu$ H, 220 $\mu$ H (Sumida Electric Co., Ltd; CD-54)  
 Diode (SBD) : MA721 (Matsushita Electronics Corporation; Schottky Type)  
 Capacitor (CL) : 47 $\mu$ F (Tantalum Type)

Using these test circuits characteristics data has been obtained as shown on the following pages.

Test Circuit 1: Typical Characteristics (1)-(7)

Test Circuit 2: Typical Characteristics (9)-(11)

Test Circuit 3: Typical Characteristics (8), (12)-(16)

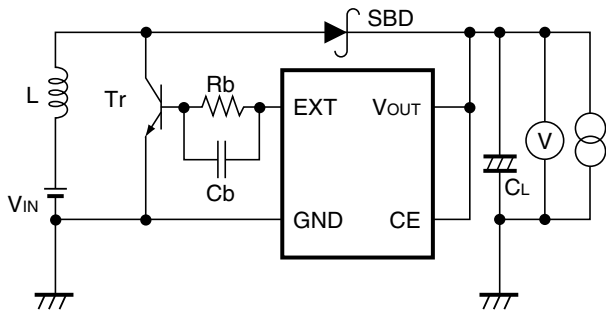

**Test Circuit 1**

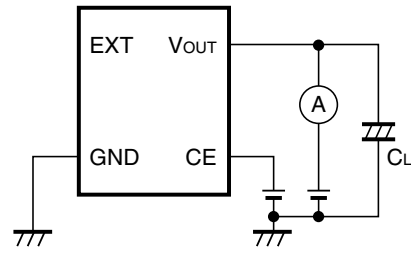

**Test Circuit 2**

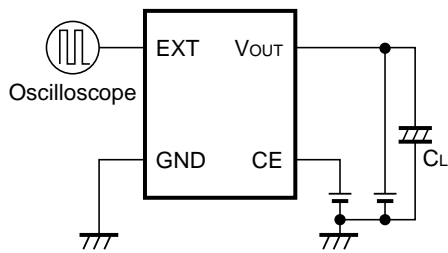

**Test Circuit 3**

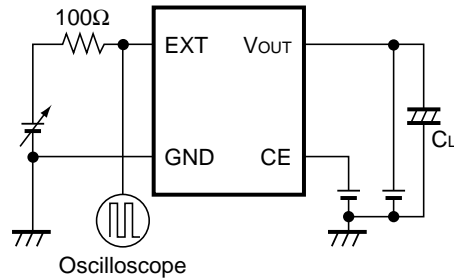

**Test Circuit 4**

Components Inductor	(L)	: 27 $\mu$ H (Sumida Electric Co., Ltd; CD-104)
Diode	(SBD)	: RB111C (Rohm Co., Ltd; Schottky Type)
Capacitor	(CL)	: 47 $\mu$ F $\times$ 2(Tantalum Type)
Transistor	(Tr)	: 2SD1628G
Base Resistor	(Rb)	: 300 $\Omega$ Base Capacitor (Cb): 0.01 $\mu$ F

The typical characteristics were obtained with using these test circuits.

- Test Circuit 1: Typical Characteristics (1)-(5)
- Test Circuit 2: Typical Characteristics (8)-(10)
- Test Circuit 3: Typical Characteristics (11)-(14)
- Test Circuit 4: Typical Characteristics (6), (7)

## TYPICAL CHARACTERISTICS

### • RN5RKxx1A/B

1) Output Voltage vs. Output Current (Topt=25°C)

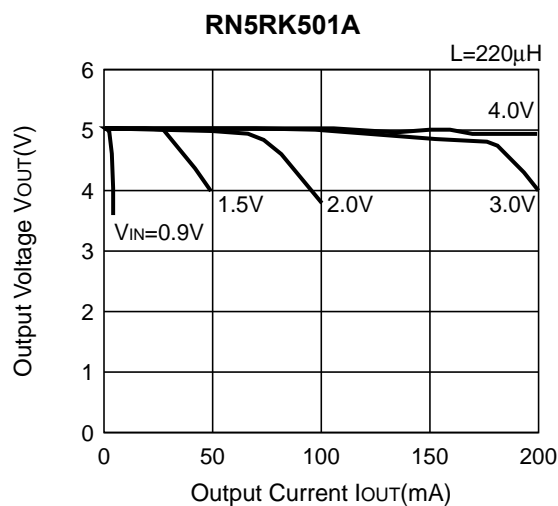
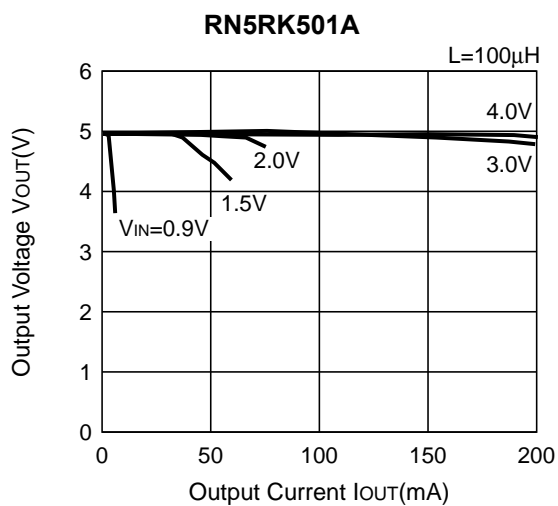
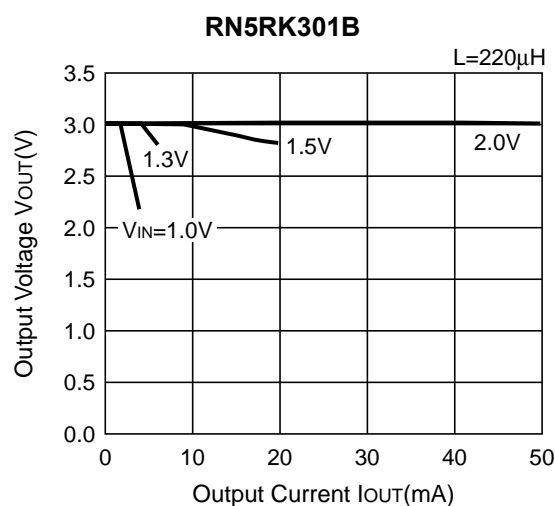
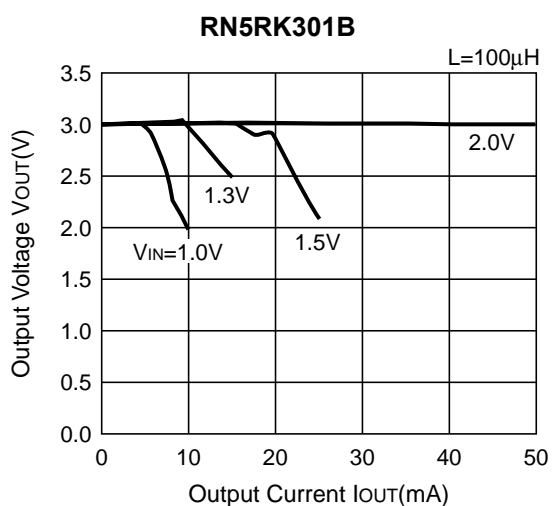
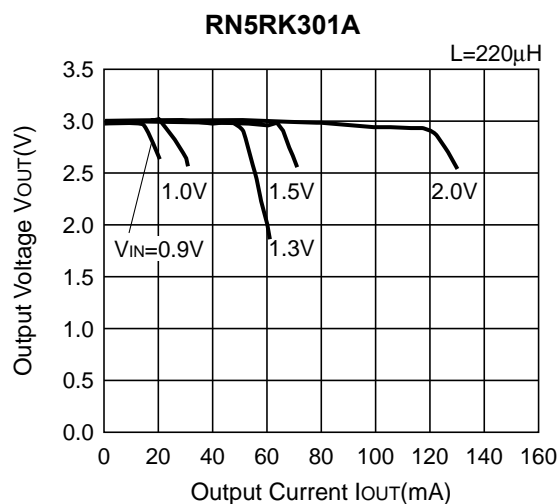
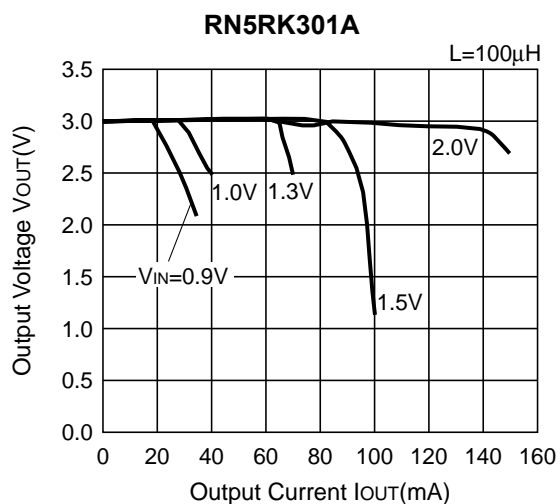

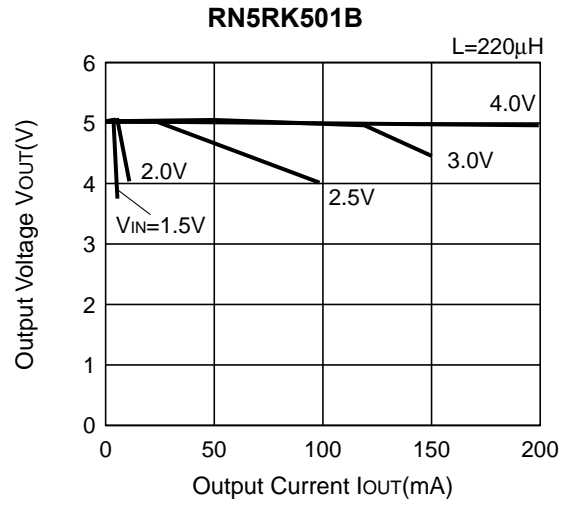
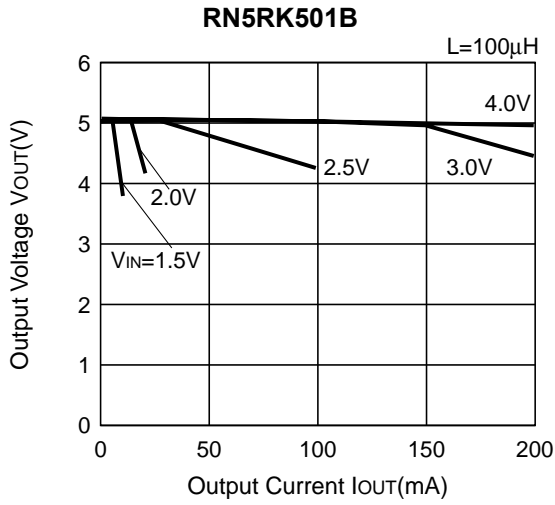

2) Efficiency vs. Output Current ( $T_{opt}=25^{\circ}C$ )

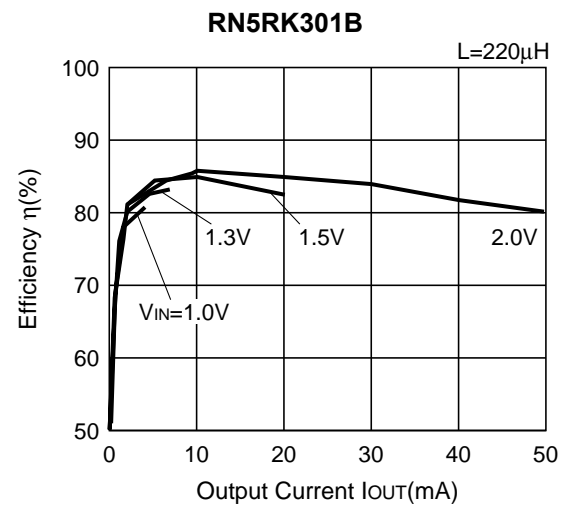
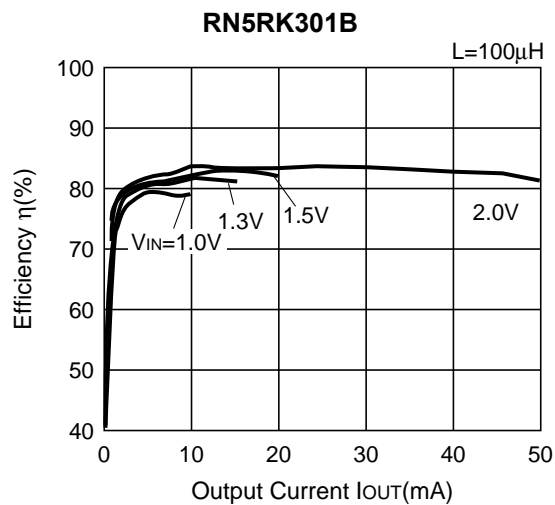
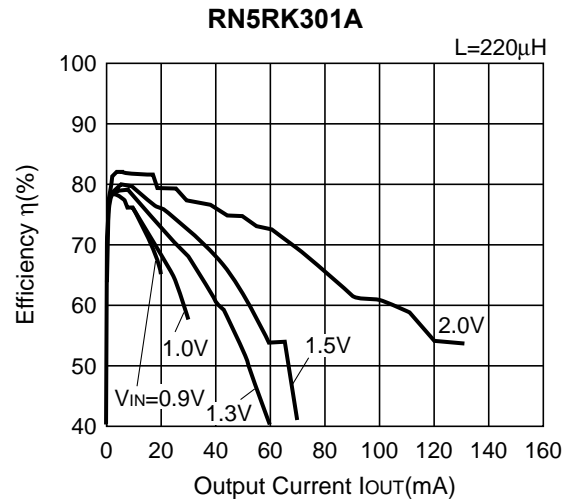
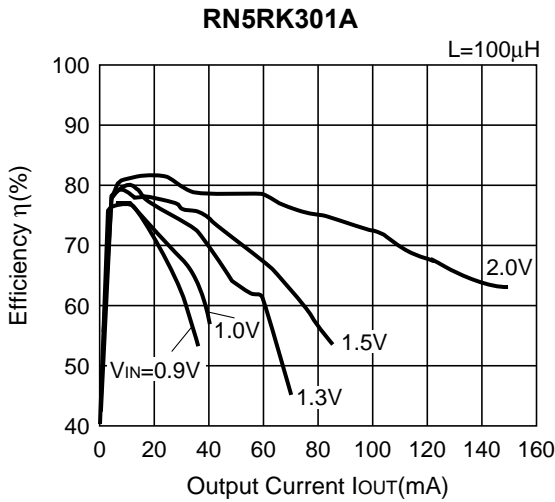

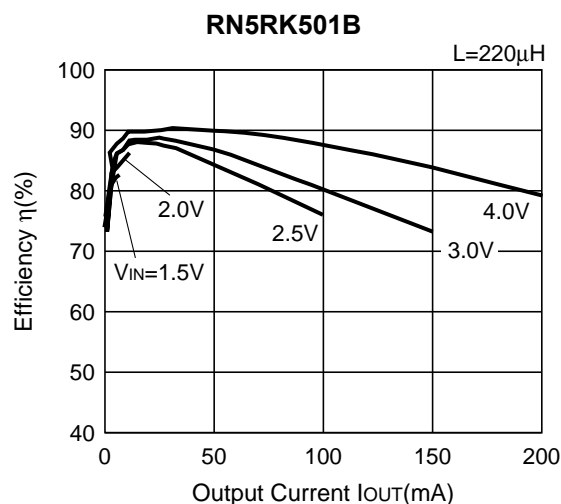
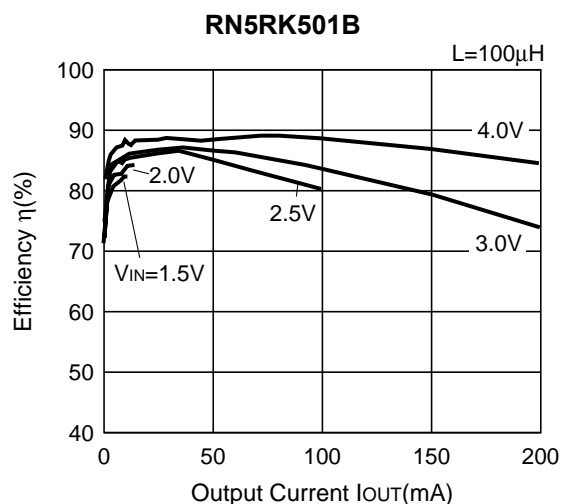
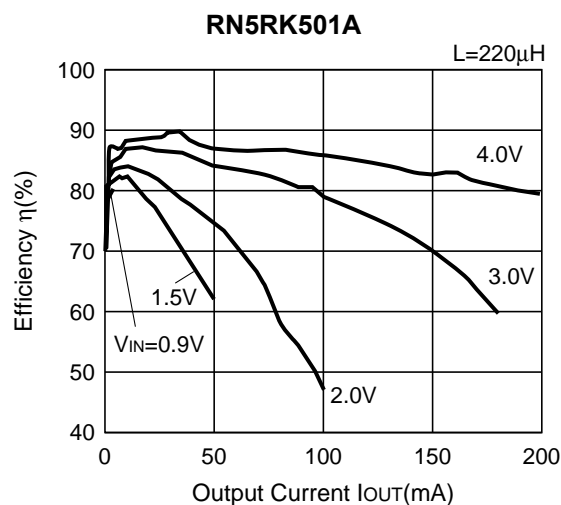
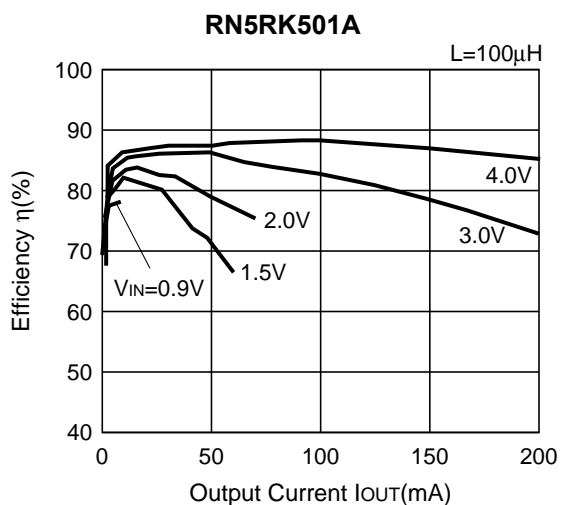

3) Ripple Voltage vs. Output Current (Topt=25°C)

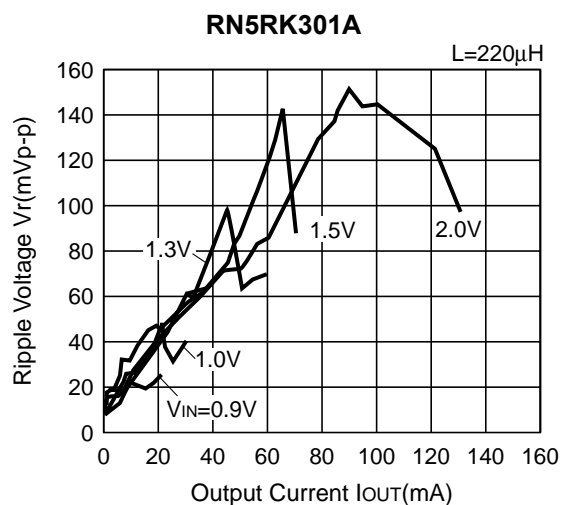
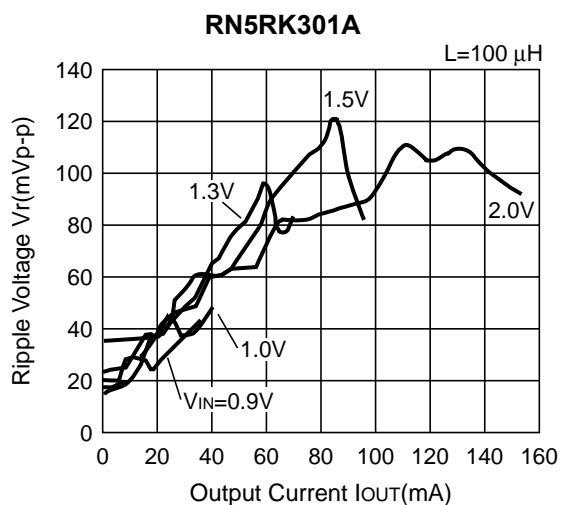

# RN5RK

NO.EA-045-181012

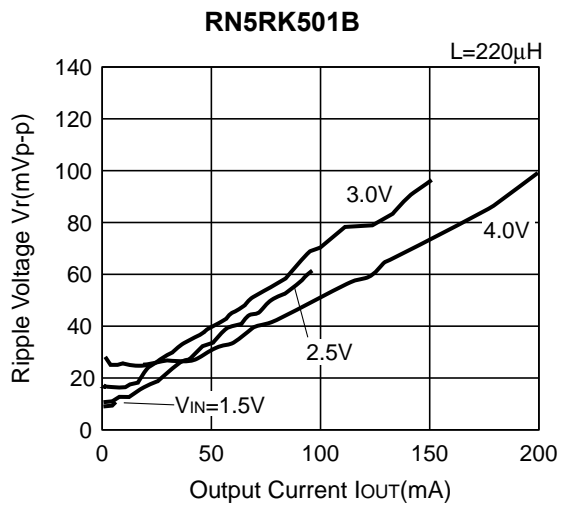
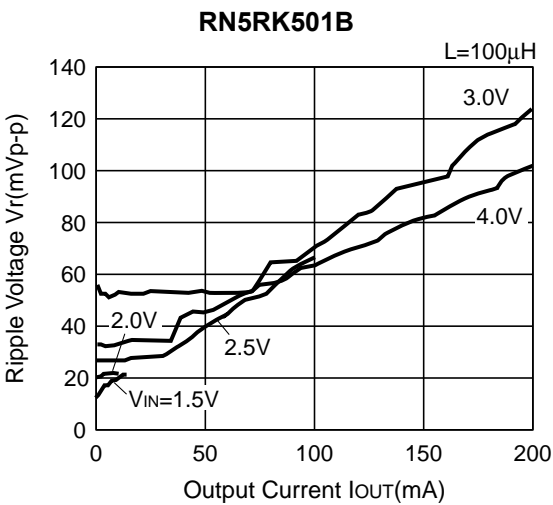
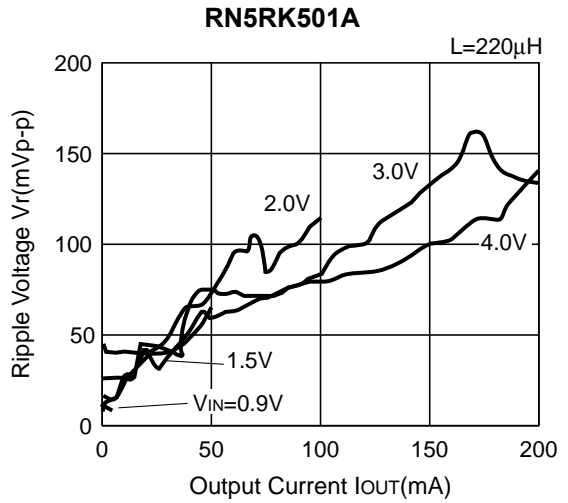
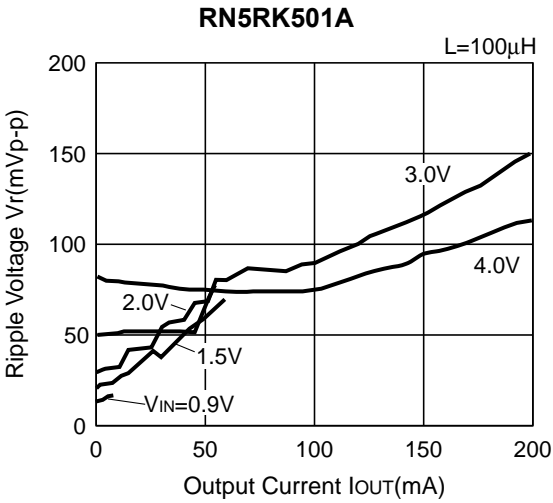
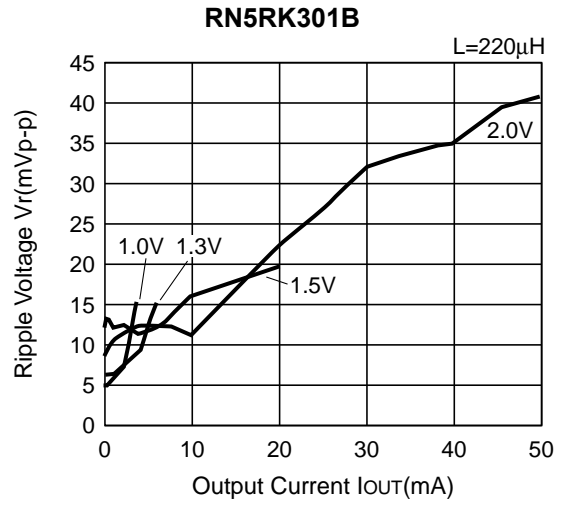
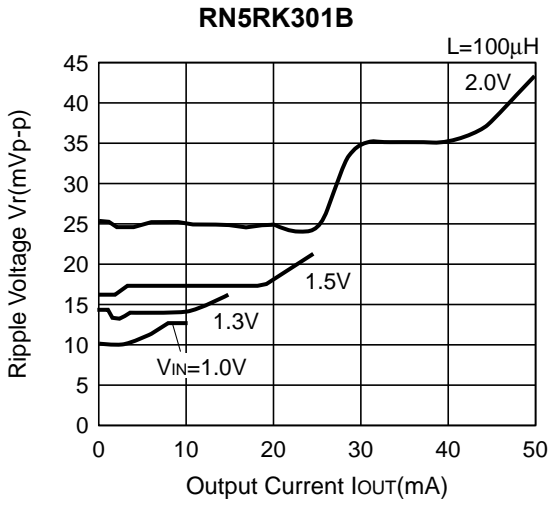

4) Start-up/Hold-on Voltage vs. Output Current (Topt=25 °C)

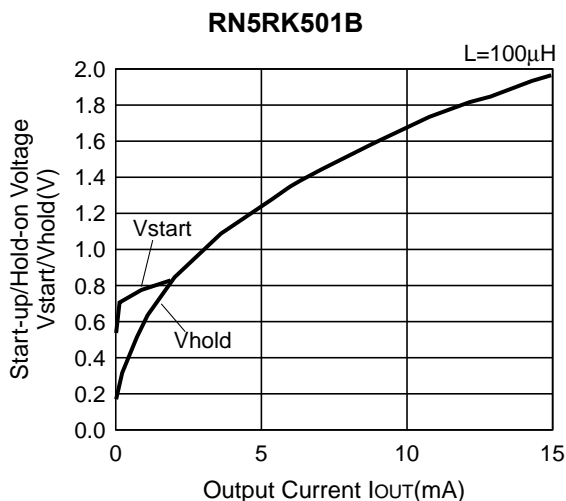
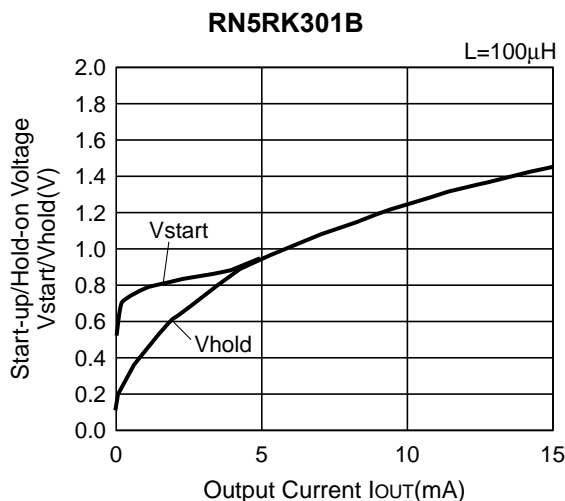
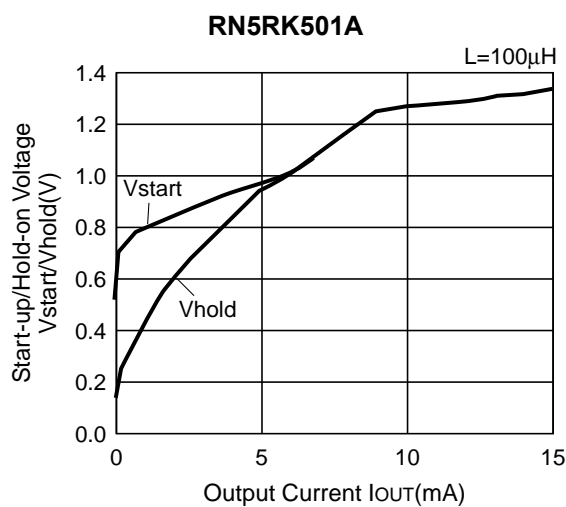
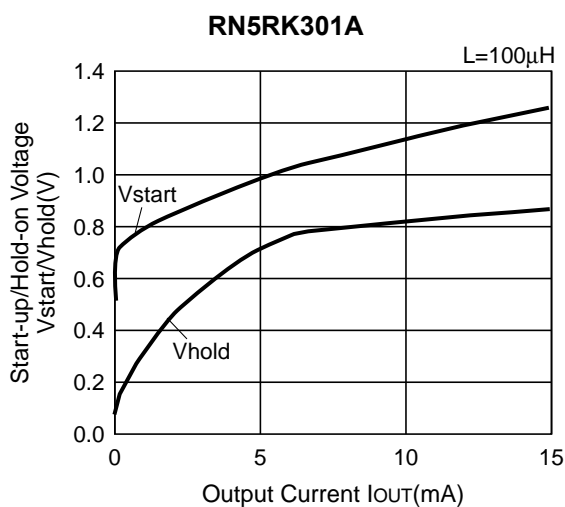

5) Output Voltage vs. Temperature

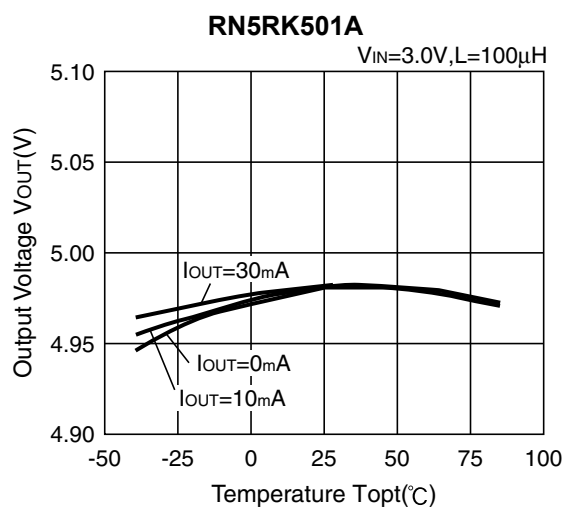
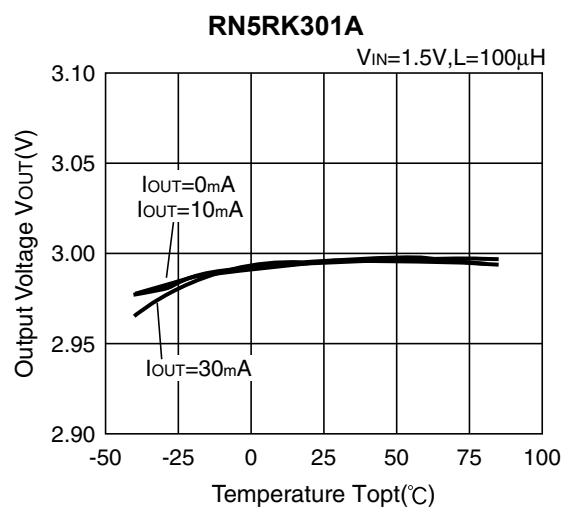

---

**RN5RK**NO.EA-045-181012

---

## 6) Start-up Voltage vs. Temperature

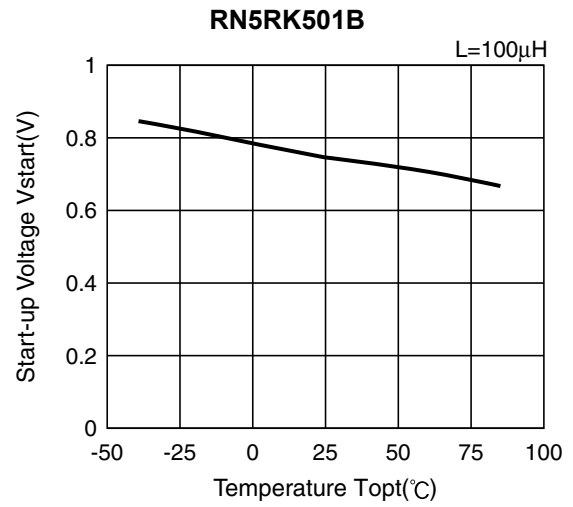
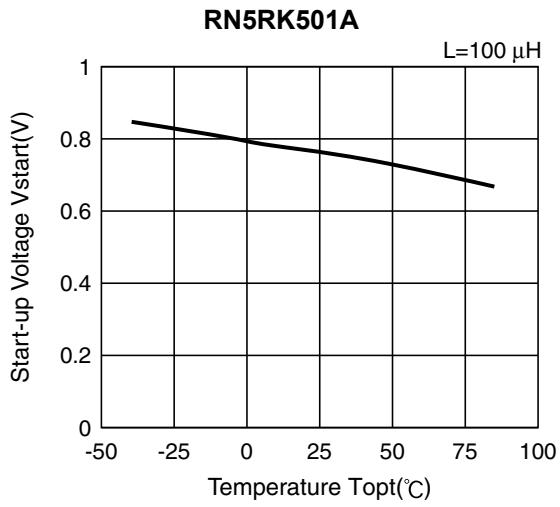

## 7) Hold-on Voltage vs. Temperature

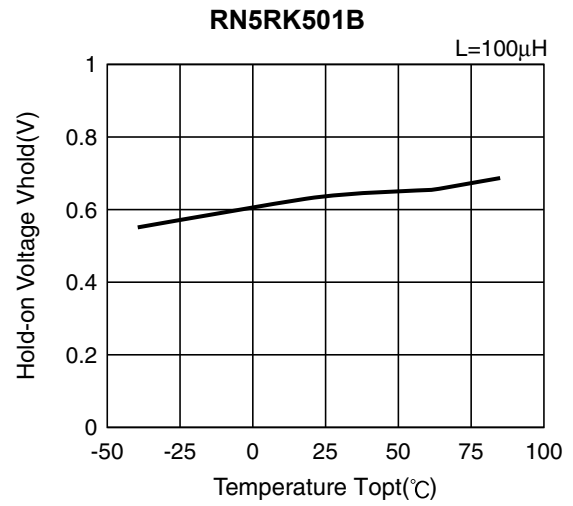
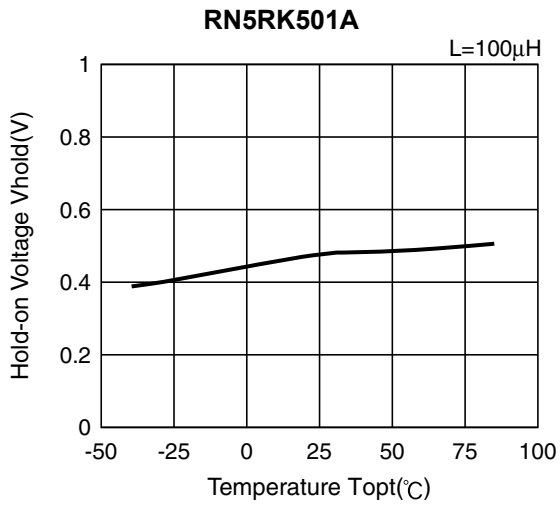

## 8) Lx Switching Current vs. Temperature

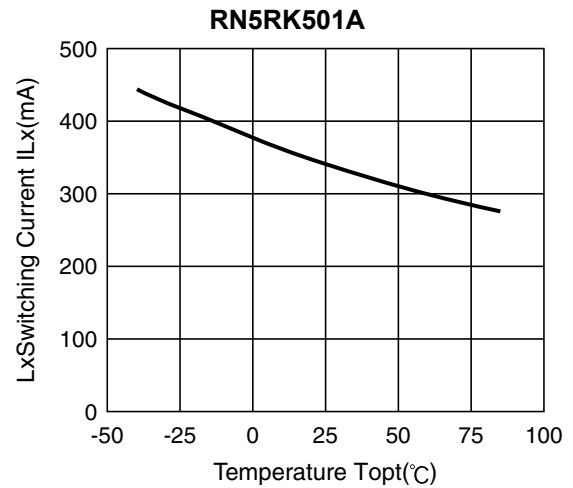
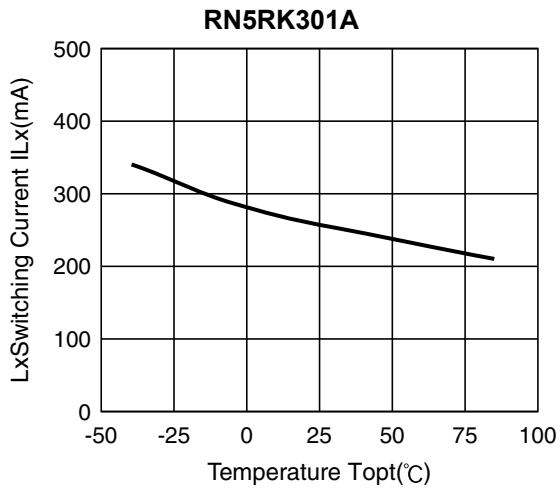



9) Supply Current 1 vs. Temperature

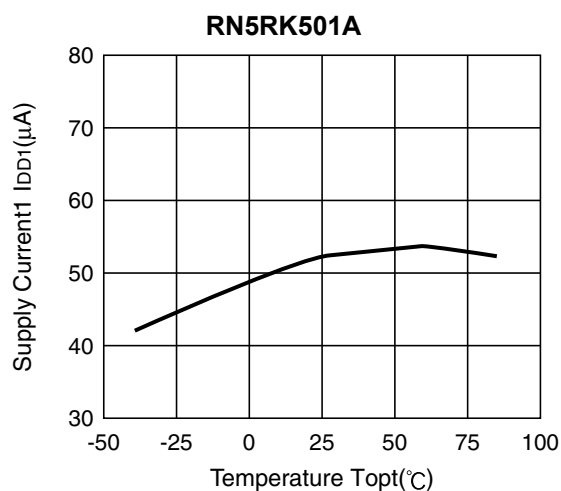
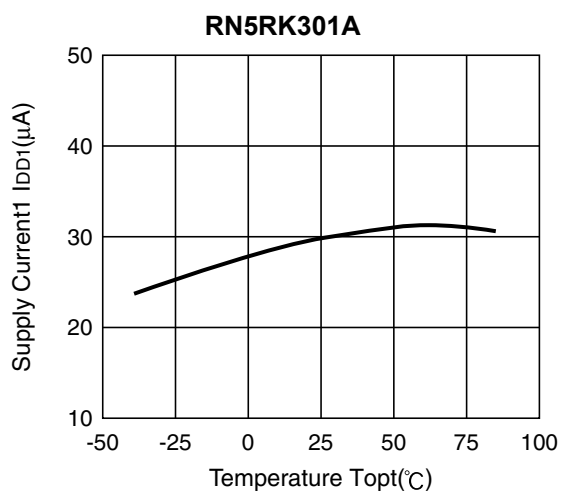

10) Supply Current 2 vs. Temperature

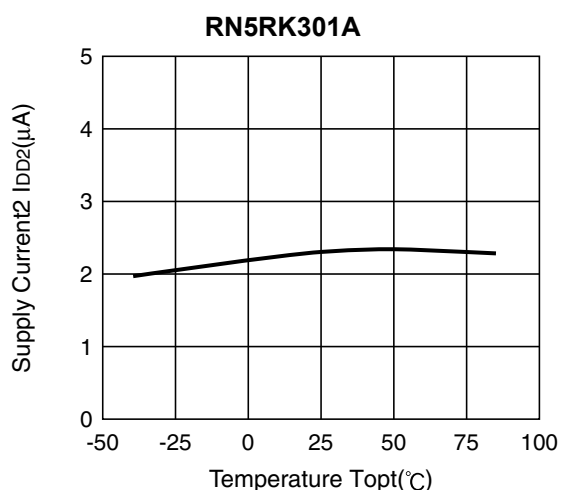

11) Standby Current 3 vs. Temperature

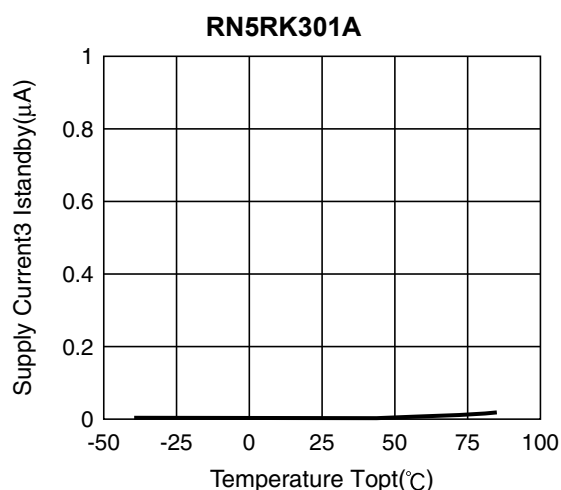

12) Oscillator Duty Cycle vs. Temperature

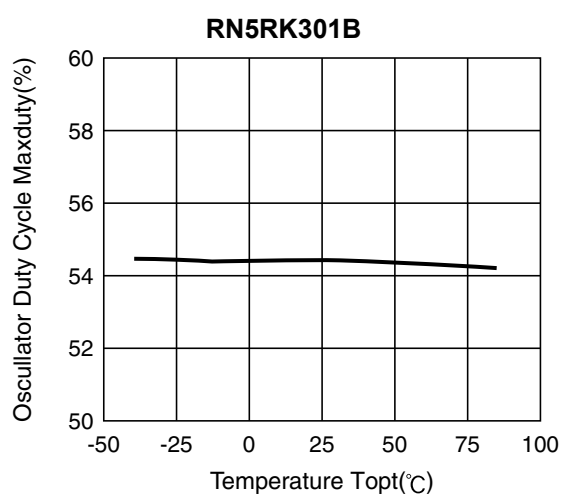
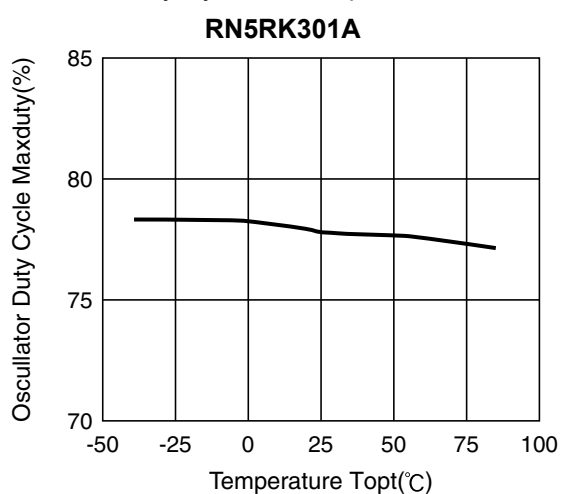

13) CE "H" Input Voltage vs. Temperature

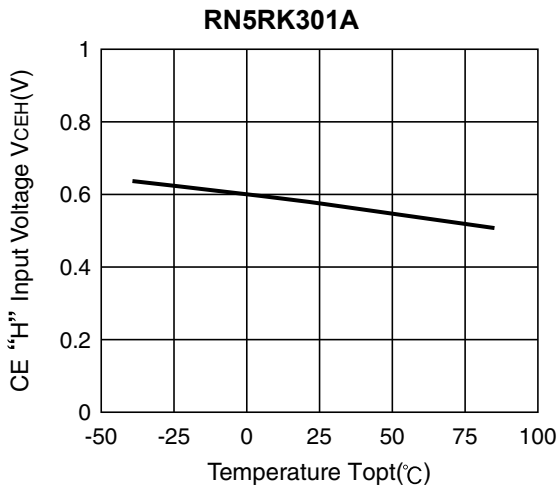

14) CE "L" Input Voltage vs. Temperature

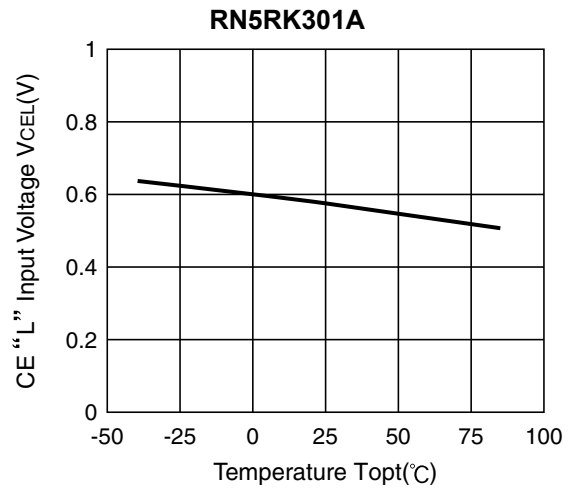

15) Maximum Oscillator Frequency vs. Temperature

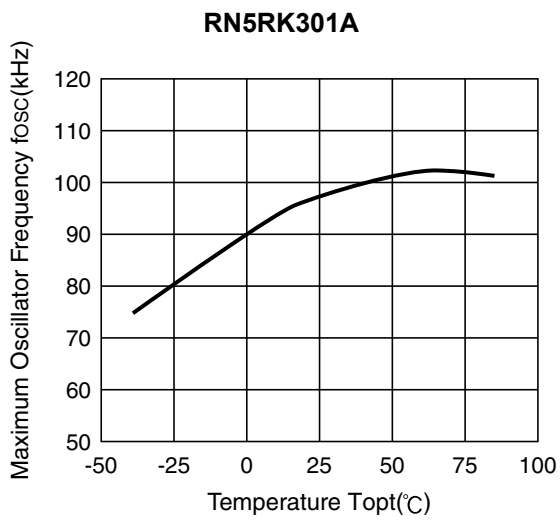

16) VLx Voltage Limit vs. Temperature

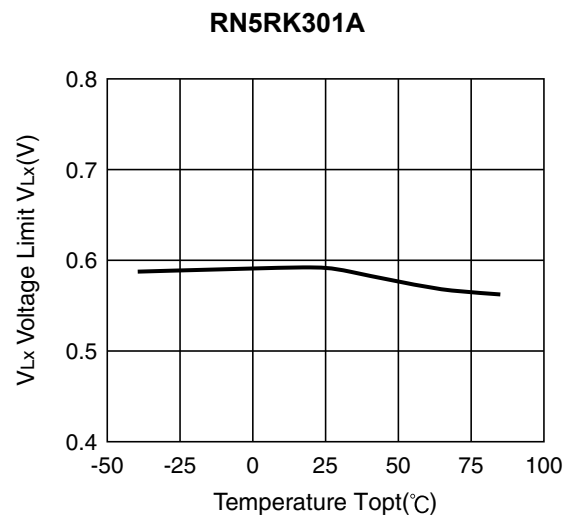

● **RN5RKxx2A**

1) Output Voltage vs. Output Current (Topt=25°C)

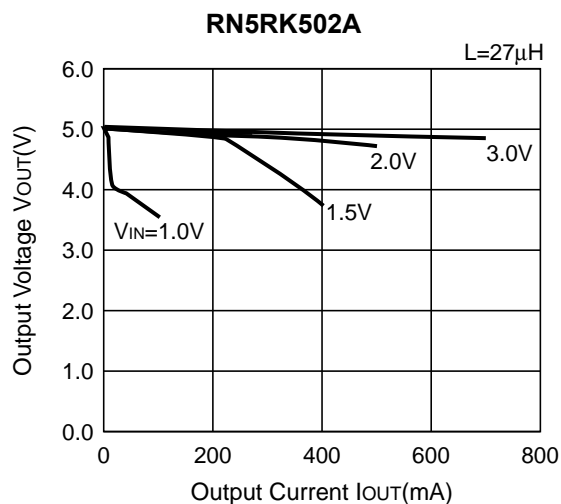
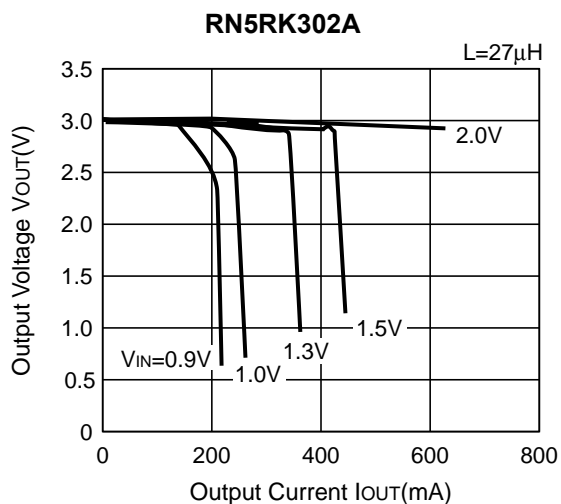

2) Efficiency vs. Output Current (Topt=25°C)

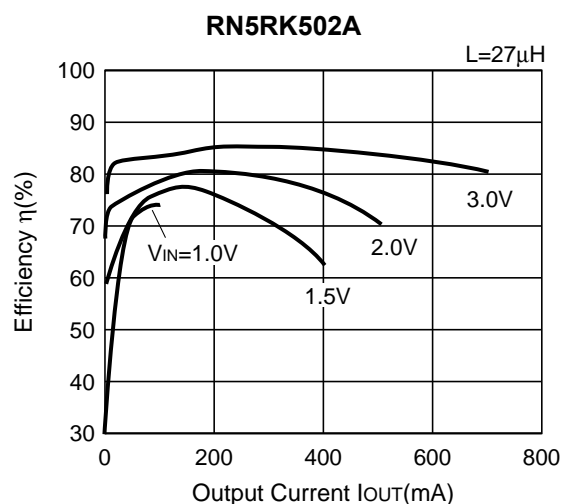
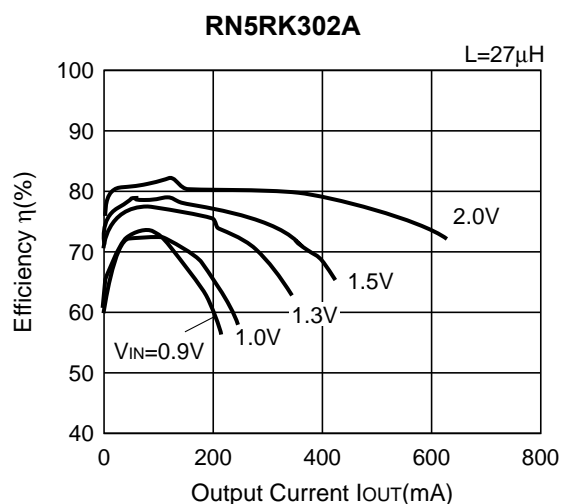

3) Ripple Voltage vs. Output Current (Topt=25°C)

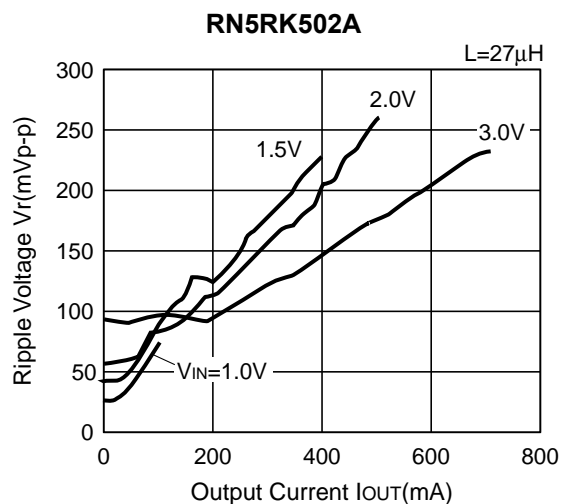
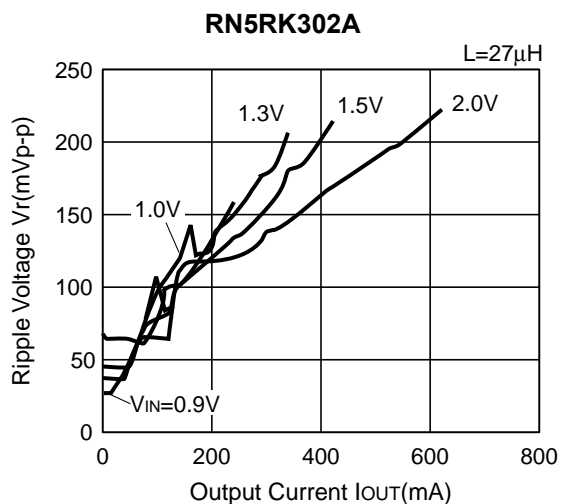

# RN5RK

NO.EA-045-181012

## 4) Start-up/Hold-on Voltage vs. Output Current (T<sub>opt</sub>=25°C)

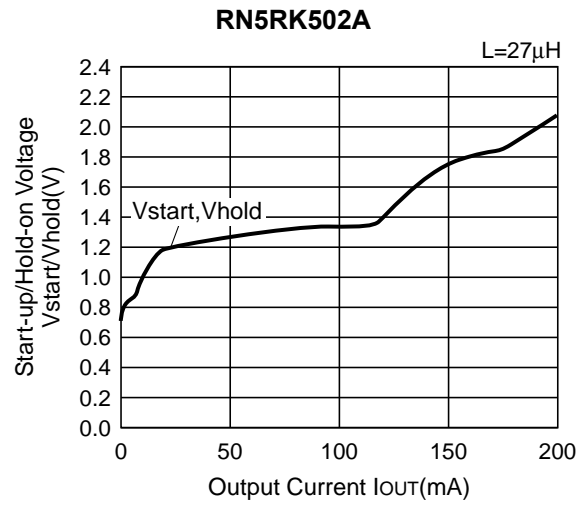
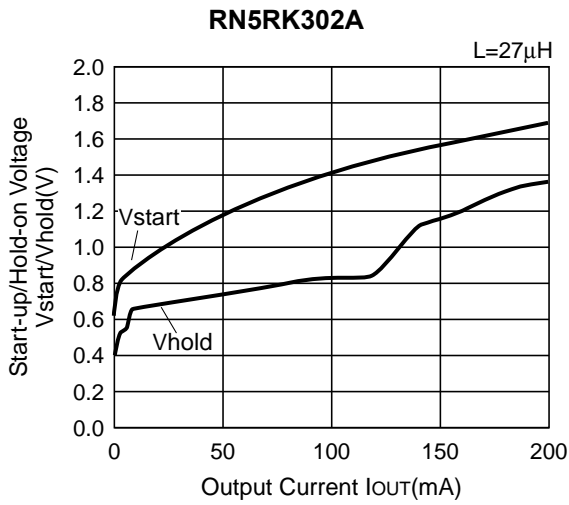

## 5) Output Voltage vs. Temperature

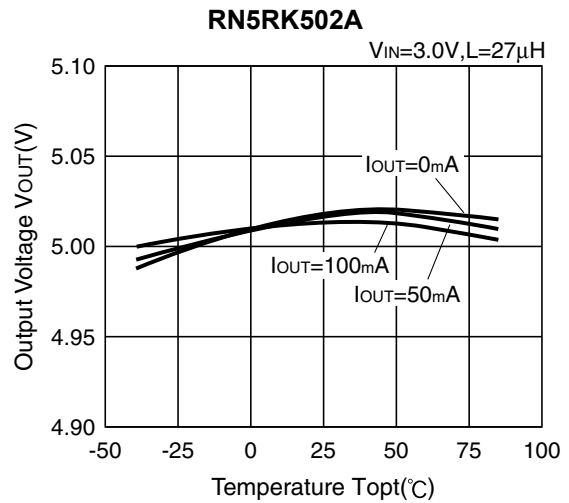
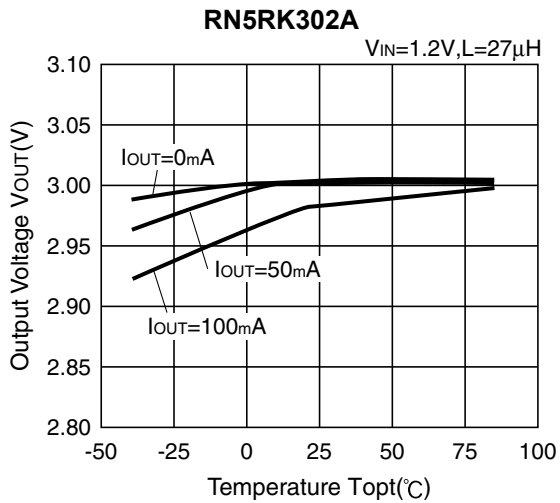

## 6) EXT "H" Output Current vs. Temperature

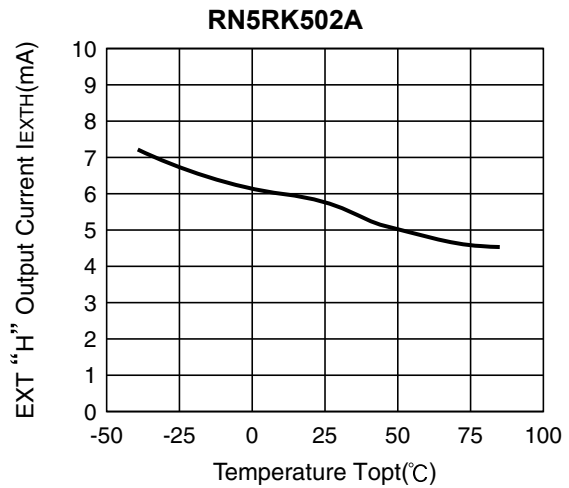
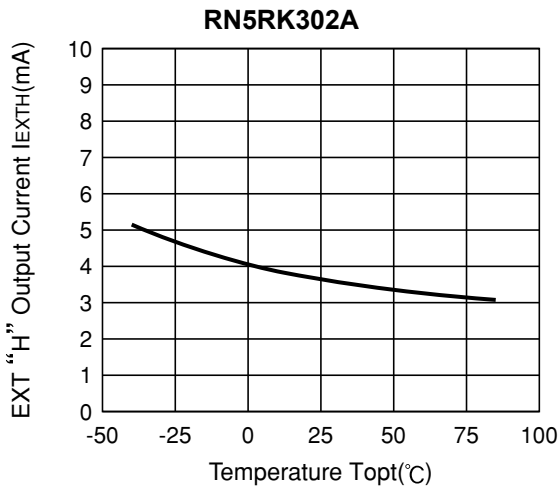

7) EXT "L" Output Current vs. Temperature

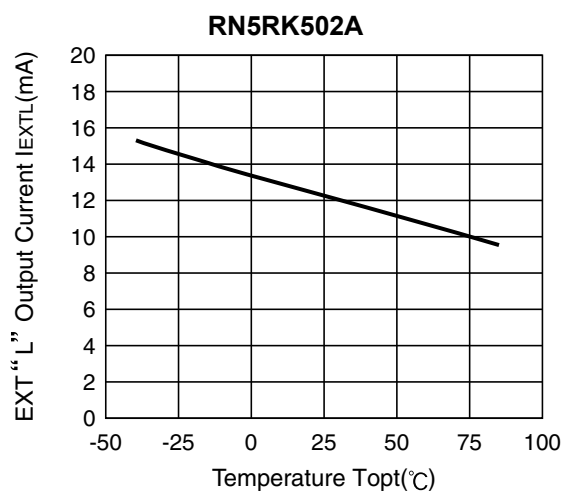
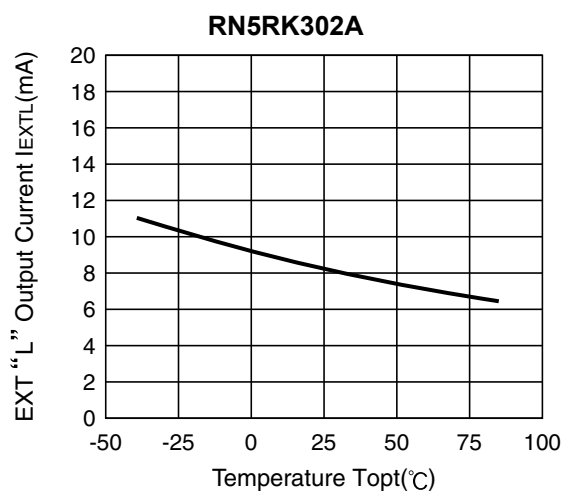

8) Supply Current 1 vs. Temperature

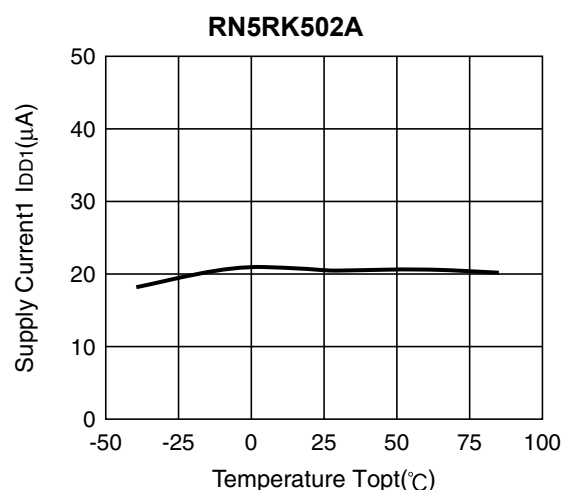
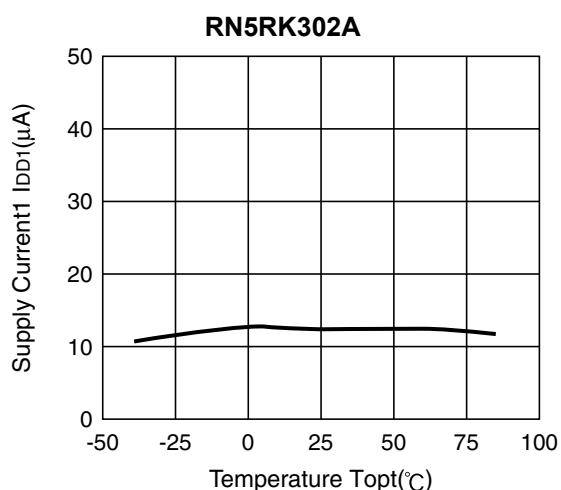

9) Supply Current 2 vs. Temperature

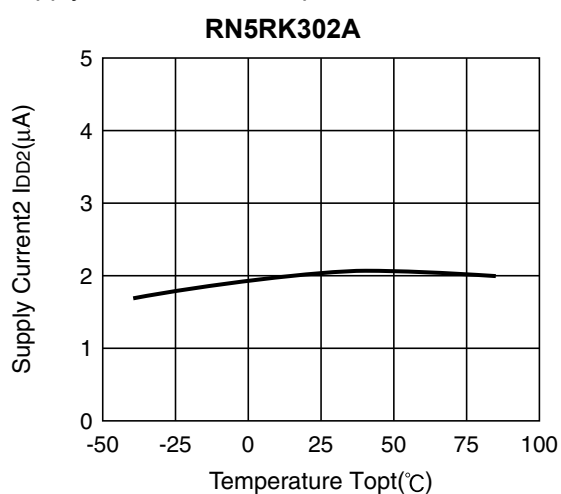

10) Standby Current vs. Temperature

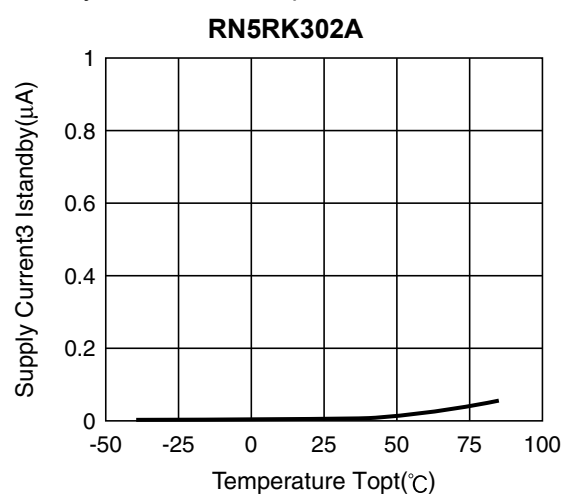

11) Oscillator Duty Cycle vs. Temperature

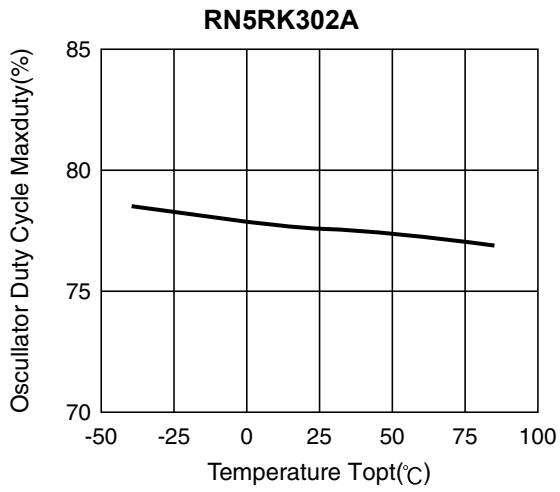

12) Maximum Oscillator Frequency vs. Temperature

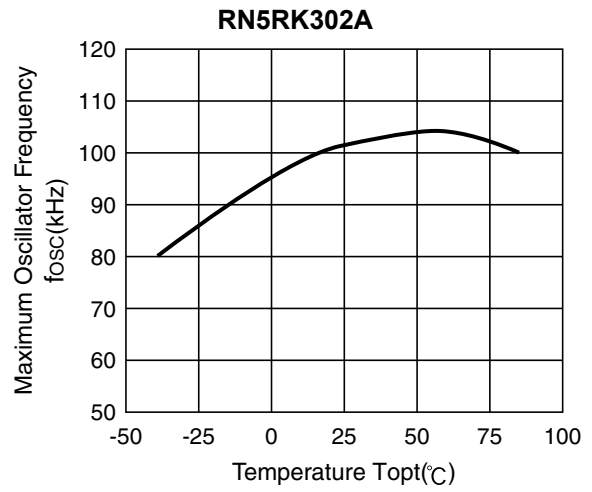

13) CE "H" Input Voltage vs. Temperature

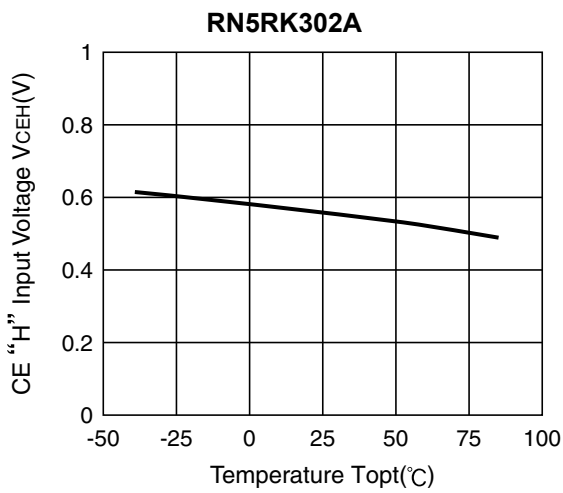

14) CE "L" Input Voltage vs. Temperature

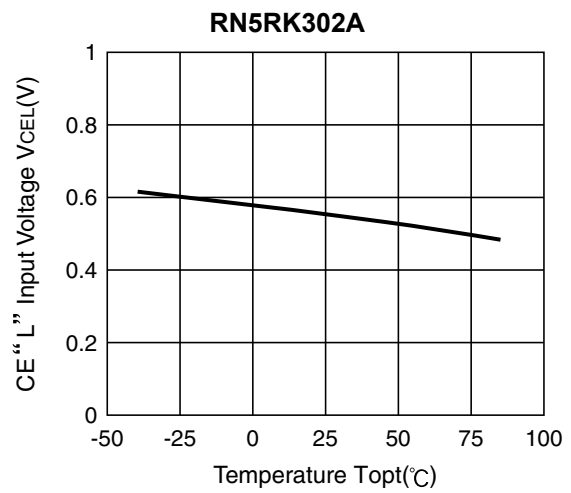



1. The products and the product specifications described in this document are subject to change or discontinuation of production without notice for reasons such as improvement. Therefore, before deciding to use the products, please refer to Ricoh sales representatives for the latest information thereon.
2. The materials in this document may not be copied or otherwise reproduced in whole or in part without prior written consent of Ricoh.
3. Please be sure to take any necessary formalities under relevant laws or regulations before exporting or otherwise taking out of your country the products or the technical information described herein.
4. The technical information described in this document shows typical characteristics of and example application circuits for the products. The release of such information is not to be construed as a warranty of or a grant of license under Ricoh's or any third party's intellectual property rights or any other rights.
5. The products listed in this document are intended and designed for use as general electronic components in standard applications (office equipment, telecommunication equipment, measuring instruments, consumer electronic products, amusement equipment etc.). Those customers intending to use a product in an application requiring extreme quality and reliability, for example, in a highly specific application where the failure or misoperation of the product could result in human injury or death (aircraft, spacevehicle, nuclear reactor control system, traffic control system, automotive and transportation equipment, combustion equipment, safety devices, life support system etc.) should first contact us.
6. We are making our continuous effort to improve the quality and reliability of our products, but semiconductor products are likely to fail with certain probability. In order to prevent any injury to persons or damages to property resulting from such failure, customers should be careful enough to incorporate safety measures in their design, such as redundancy feature, fire containment feature and fail-safe feature. We do not assume any liability or responsibility for any loss or damage arising from misuse or inappropriate use of the products.
7. Anti-radiation design is not implemented in the products described in this document.
8. The X-ray exposure can influence functions and characteristics of the products. Confirm the product functions and characteristics in the evaluation stage.
9. WLCSP products should be used in light shielded environments. The light exposure can influence functions and characteristics of the products under operation or storage.
10. There can be variation in the marking when different AOI (Automated Optical Inspection) equipment is used. In the case of recognizing the marking characteristic with AOI, please contact Ricoh sales or our distributor before attempting to use AOI.
11. Please contact Ricoh sales representatives should you have any questions or comments concerning the products or the technical information.



**Ricoh is committed to reducing the environmental loading materials in electrical devices with a view to contributing to the protection of human health and the environment.**

Ricoh has been providing RoHS compliant products since April 1, 2006 and Halogen-free products since April 1, 2012.

**RICOH** RICOH ELECTRONIC DEVICES CO., LTD.

<https://www.e-devices.ricoh.co.jp/en/>

#### Sales & Support Offices

##### **Ricoh Electronic Devices Co., Ltd.**

##### **Shin-Yokohama Office (International Sales)**

2-3, Shin-Yokohama 3-chome, Kohoku-ku, Yokohama-shi, Kanagawa, 222-8530, Japan  
Phone: +81-50-3814-7687 Fax: +81-45-474-0074

##### **Ricoh Americas Holdings, Inc.**

675 Campbell Technology Parkway, Suite 200 Campbell, CA 95008, U.S.A.  
Phone: +1-408-610-3105

##### **Ricoh Europe (Netherlands) B.V.**

##### **Semiconductor Support Centre**

Prof. W.H. Keesomlaan 1, 1183 DJ Amstelveen, The Netherlands  
Phone: +31-20-5474-309

##### **Ricoh International B.V. - German Branch**

##### **Semiconductor Sales and Support Centre**

Oberrather Strasse 6, 40472 Düsseldorf, Germany  
Phone: +49-211-6546-0

##### **Ricoh Electronic Devices Korea Co., Ltd.**

3F, Haesung Bldg, 504, Teheran-ro, Gangnam-gu, Seoul, 135-725, Korea  
Phone: +82-2-2135-5700 Fax: +82-2-2051-5713

##### **Ricoh Electronic Devices Shanghai Co., Ltd.**

Room 403, No.2 Building, No.690 Bibo Road, Pu Dong New District, Shanghai 201203,  
People's Republic of China  
Phone: +86-21-5027-3200 Fax: +86-21-5027-3299

##### **Ricoh Electronic Devices Shanghai Co., Ltd.**

##### **Shenzhen Branch**

1205, Block D (Jinlong Building), Kingkey 100, Hongbao Road, Luohu District,  
Shenzhen, China  
Phone: +86-755-8348-7600 Ext 225

##### **Ricoh Electronic Devices Co., Ltd.**

##### **Taipei office**

Room 109, 10F-1, No.51, Hengyang Rd., Taipei City, Taiwan  
Phone: +886-2-2313-1621/1622 Fax: +886-2-2313-1623

# Mouser Electronics

Authorized Distributor

Click to View Pricing, Inventory, Delivery & Lifecycle Information:

## Ricoh Electronics:

[RN5RK551A-TR-FE](#) [RN5RK502A-TR-FE](#) [RN5RK501A-TR-FE](#) [RN5RK452A-TR-FE](#) [RN5RK331A-TR-FE](#)  
[RN5RK331B-TR-FE](#) [RN5RK501B-TR-FE](#) [RN5RK332A-TR-FE](#) [RN5RK301A-TR-FE](#) [RN5RK251B-TR-FE](#)  
[RN5RK201B-TR-FE](#) [RN5RK202A-TR-FE](#) [RN5RK211A-TR-FE](#) [RN5RK221A-TR-FE](#) [RN5RK221B-TR-FE](#)  
[RN5RK241A-TR-FE](#) [RN5RK552A-TR-FE](#) [RN5RK462A-TR-FE](#) [RN5RK472A-TR-FE](#) [RN5RK511A-TR-FE](#)  
[RN5RK522A-TR-FE](#) [RN5RK532A-TR-FE](#) [RN5RK551B-TR-FE](#) [RN5RK391B-TR-FE](#) [RN5RK401A-TR-FE](#)  
[RN5RK401B-TR-FE](#) [RN5RK402A-TR-FE](#) [RN5RK421B-TR-FE](#) [RN5RK451A-TR-FE](#) [RN5RK352A-TR-FE](#)  
[RN5RK361A-TR-FE](#) [RN5RK361B-TR-FE](#) [RN5RK362A-TR-FE](#) [RN5RK381B-TR-FE](#) [RN5RK391A-TR-FE](#)  
[RN5RK302A-TR-FE](#) [RN5RK311A-TR-FE](#) [RN5RK321A-TR-FE](#) [RN5RK321B-TR-FE](#) [RN5RK351A-TR-FE](#)  
[RN5RK351B-TR-FE](#) [RN5RK251A-TR-FE](#) [RN5RK252A-TR-FE](#) [RN5RK271A-TR-FE](#) [RN5RK271B-TR-FE](#)  
[RN5RK272A-TR-FE](#) [RN5RK301B-TR-FE](#)