

1 Channel Compact High Side Switch ICs

Output OFF Latch High Side Switch ICs

BD6538G-LB

General Description

This product guarantees long time support in Industrial market.

BD6538G is single channel high side powers switch with low ON resistance Nch power MOSFET.

Rich safety functions such as Over current detection, Thermal shutdown (TSD), Under Voltage Lock Out(UVLO) and Soft start function which are required for the power supply port protection are integrated into 1chip.

Features

- Long time support a product for Industrial applications.
- Single channel of low ON resistance (Typ = 150mΩ) Nch power MOSFET built in
- 500mA Continuous current load
- Active"High"Control Logic
- Soft start function
- Over current detection (Output Off-latch Operating
- Thermal shutdown
- Open drain error flag output
- Under voltage lockout

Key Specifications

- Input voltage range: 2.7V to 5.5V
- ON resistance : 150mΩ(Typ.)
- Over current threshold: 0.5A min., 1.0A max.
- Standby current: 0.01μA (Typ.)
- Operating temperature range: -40°C to +85°C

Package

SSOP5

W(Typ.) D(Typ.) H (Max.)

2.90mm x 2.80mm x 1.25mm

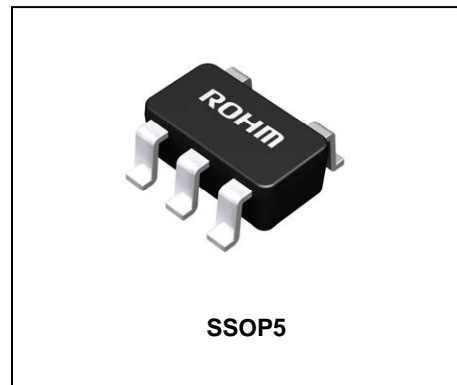

Applications

Industrial Equipment,

Typical Application Circuit

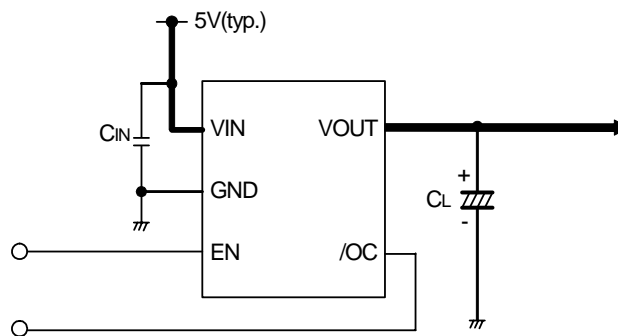

Lineup

Over current detection			Control input logic	Package		Orderable Part Number
Min.	Typ.	Max.				
0.5A	-	1.0A	High	SSOP5	Reel of 3000	BD6538G – LBTR

Block Diagram

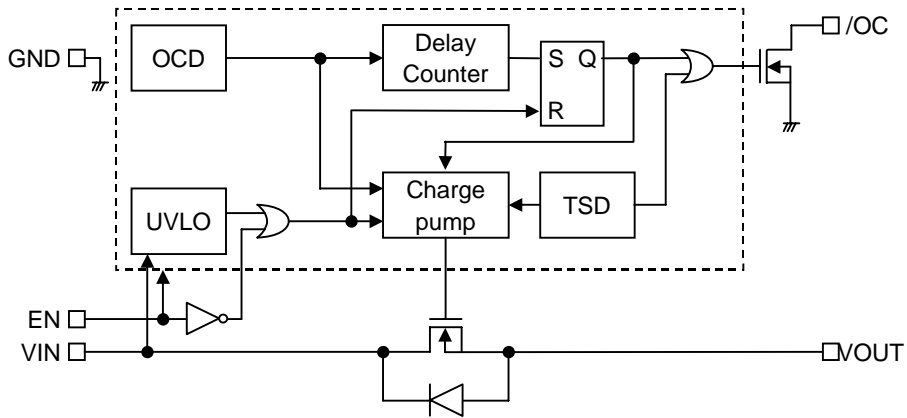

Pin Configuration

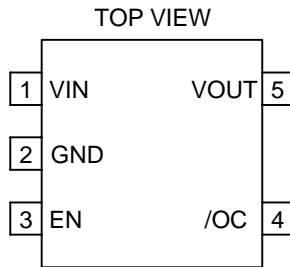

Pin Description

Pin No.	Symbol	I/O	Pin function
1	VIN	-	Power supply input. Input terminal to switch and power supply input terminal of the internal circuit.
2	GND	-	Ground.
3	EN	I	Enable input. Power switch on at High level.
4	/OC	O	Over current output. Low level at over current detection. Open drain output.
5	VOUT	O	Switch output.

Absolute Maximum Ratings(Ta=25°C)

Parameter	Symbol	Ratings	Unit
Supply voltage	V _{IN}	-0.3 to 6.0	V
Enable voltage	V _{EN}	-0.3 to 6.0	V
/OC voltage	V _{/OC}	-0.3 to 6.0	V
/OC current	I _{/OC}	5	mA
OUT voltage	V _{OUT}	-0.3 to V _{IN} + 0.3	V
Storage temperature	T _{STG}	-55 to 150	°C
Power dissipation	PD	675 ^{*1}	mW

*1 1 Mounted on 70mm * 70mm * 1.6mm grass-epoxy PCB. Derating : 5.4mW / °C for operating above Ta=25°C.

Recommended Operating Ratings

Parameter	Symbol	Ratings			Unit
		Min	Typ	Max	
Operating voltage	V _{IN}	2.7	-	5.5	V
Operating temperature	T _{OPR}	-40	-	85	°C
Continuous output current	I _{OUT}	0	-	0.5	A

Electrical Characteristics

Unless otherwise specified V_{IN} = 5.0V, Ta = 25°C

DC characteristics

Parameter	Symbol	Limits			unit	Condition
		Min.	Typ.	Max.		
Operating Current	I _{DD}	-	110	160	μA	V _{EN} = 5.0V, V _{OUT} = Open
Standby Current	I _{STB}	-	0.01	5	μA	V _{EN} = 0V, V _{OUT} = Open
EN input voltage	V _{EN}	2.0	-	-	V	High input
	V _{EN}	-	-	0.8	V	Low input
EN input current	I _{EN}	-1.0	0.01	1.0	μA	V _{EN} = 0V or 5V
ON resistance	R _{ON}	-	150	200	mΩ	I _{OUT} = 50mA
Over current threshold	I _{TH}	0.5	-	1.0	A	-
Output current at short	I _{SC}	0.35	-	-	A	V _{OUT} = 0V (RMS)
/OC output IOW voltage	V _{/OC}	-	-	0.4	V	I _{/OC} = 0.5mA
UVLO Threshold	V _{TUVH}	2.1	2.3	2.5	V	Increasing V _{IN}
	V _{TUVL}	2.0	2.2	2.4	V	Decreasing V _{IN}

AC characteristics

Parameter	Symbol	Limits			unit	Condition
		Min.	Typ.	Max.		
Output rise time	T _{ON1}	-	1	6	ms	R _L = 20Ω, Figure 2. Ref.
Output rise delay time	T _{ON2}	-	1.5	10	ms	R _L = 20Ω, Figure 2. Ref.
Output fall time	T _{OFF1}	-	1	20	μs	R _L = 20Ω, Figure 2. Ref.
Output fall delay time	T _{OFF2}	-	3	40	μs	R _L = 20Ω, Figure 2. Ref.
Blanking time	T _{BLANK}	10	15	20	ms	-

Measurement Circuit

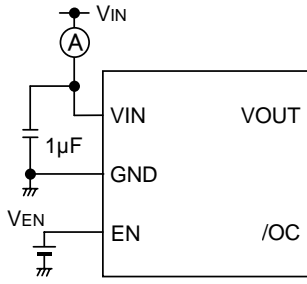

A. Operating current

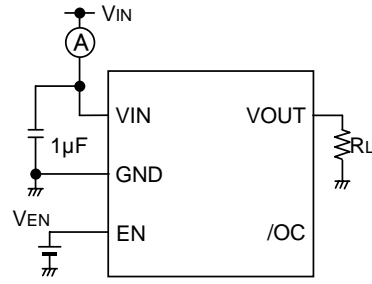

B. EN input voltage, Output rise, fall time

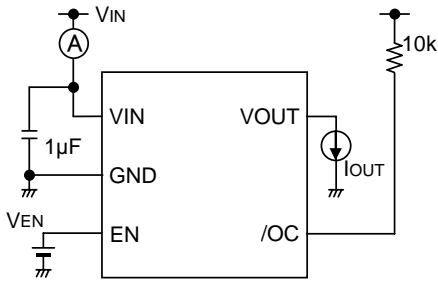

C. ON resistance, Over current detection

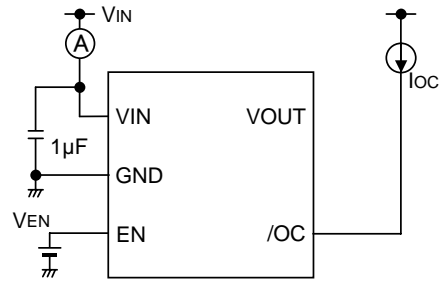

D. /OC output LOW voltage

Figure 1. Measurement circuit

Timing Diagram

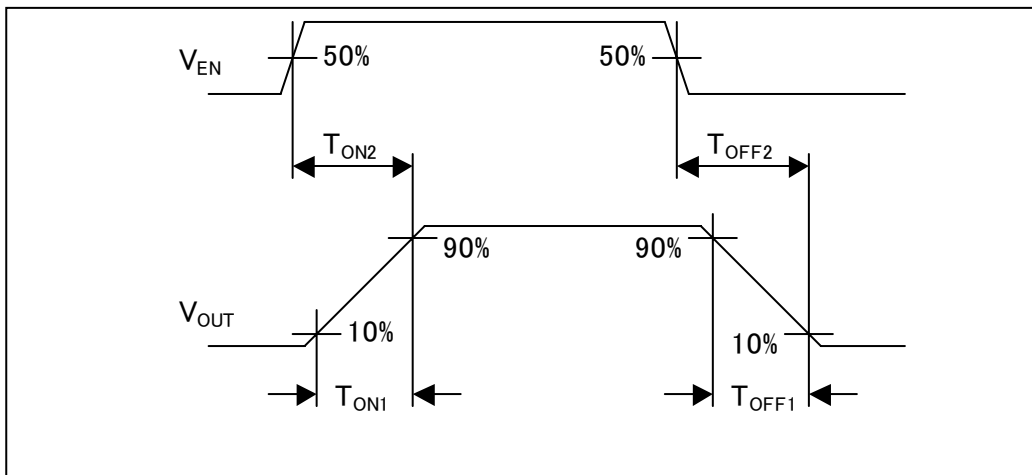

Figure 2. Timing chart at output rise / fall time

Typical Performance Curves

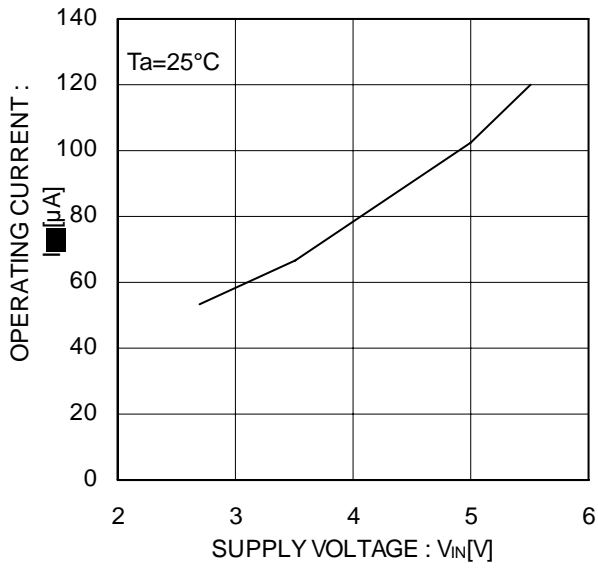

Figure 3. Operating current EN Enable

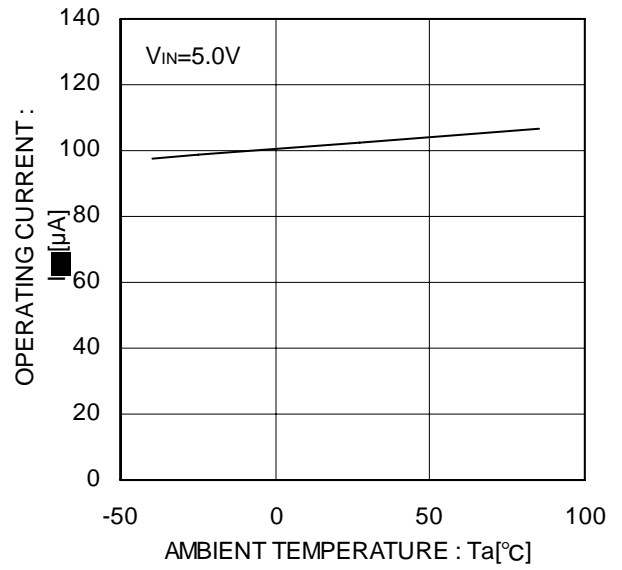

Figure 4. Operating current EN Enable

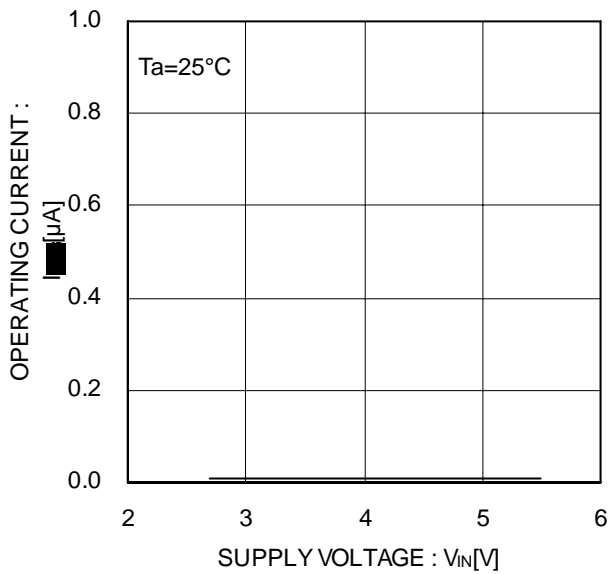

Figure 5. Operating current EN Disable

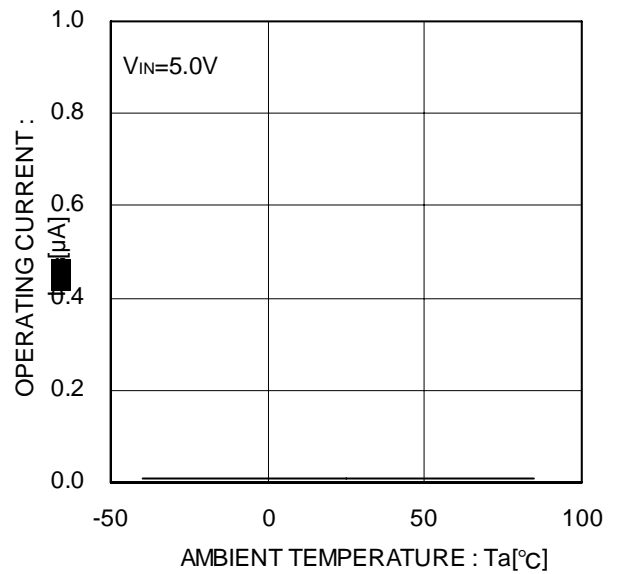

Figure 6. Operating current EN Disable

Typical Performance Curves - continued

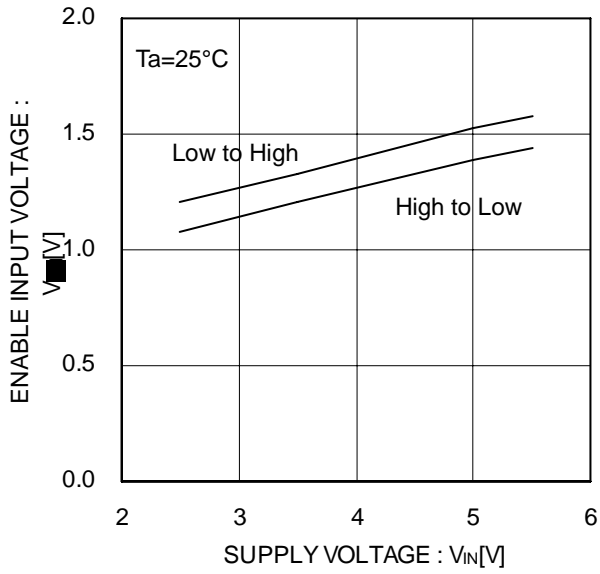

Figure 7. EN input voltage

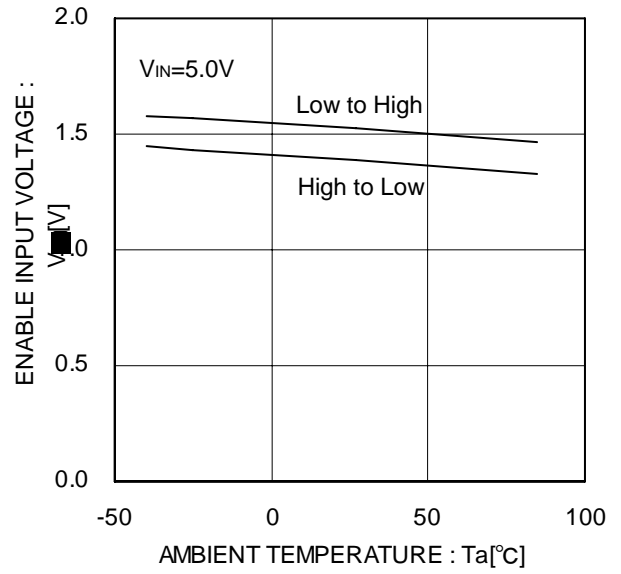

Figure 8. EN input voltage

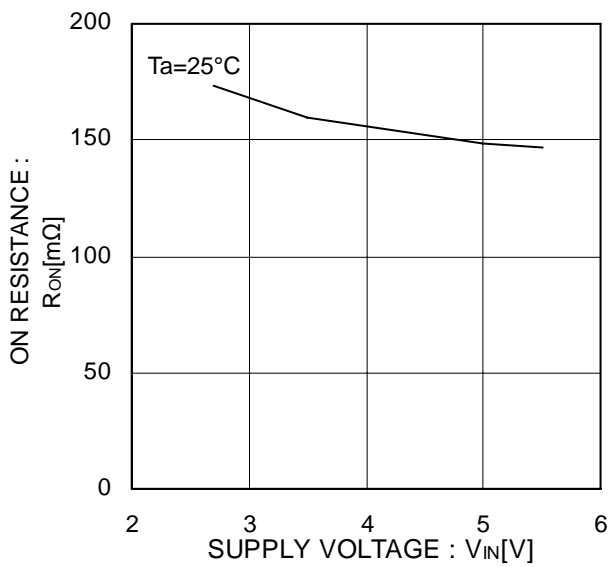

Figure 9. ON resistance

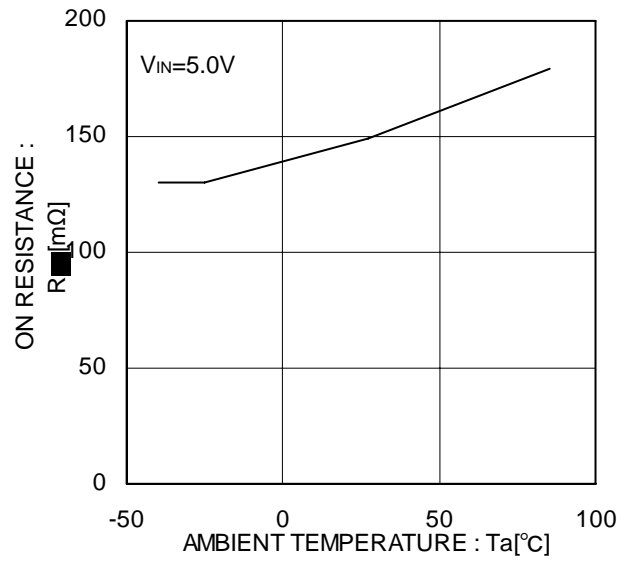

Figure 10. ON resistance

Typical Performance Curves - continued

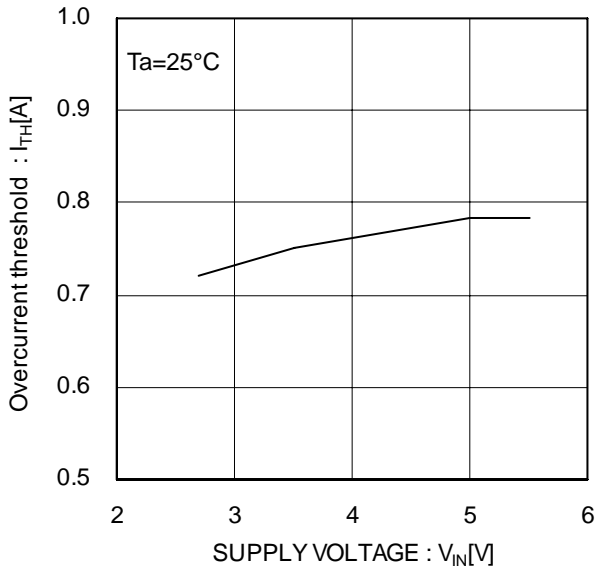

Figure 11. Over current detection

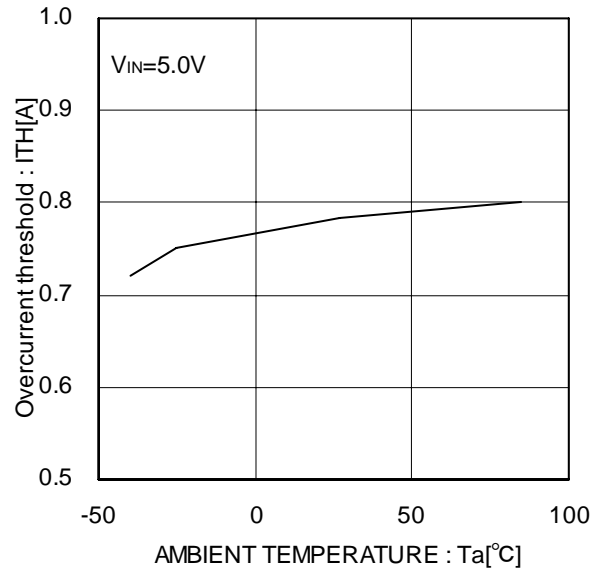

Figure 12. Over current detection

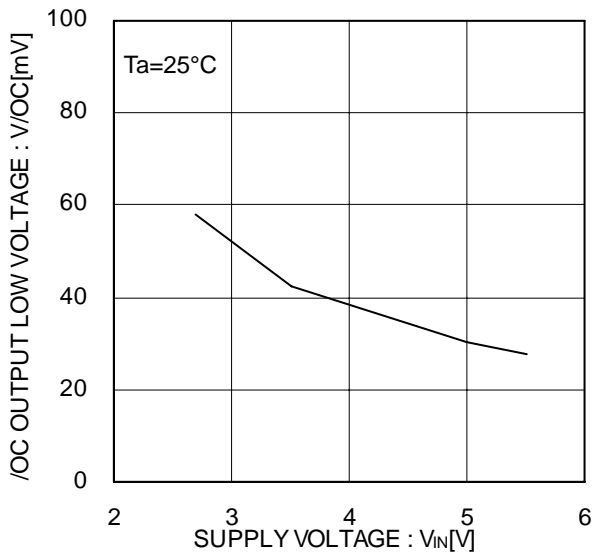

Figure 13. /OC output LOW voltage

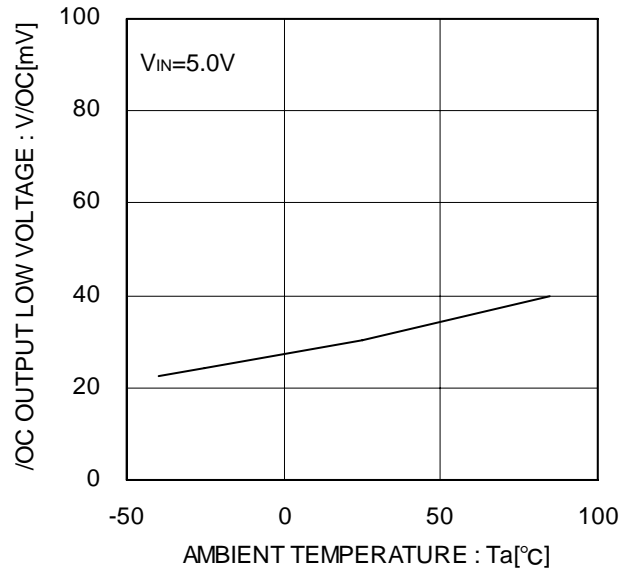

Figure 14. /OC output LOW voltage

Typical Performance Curves - continued

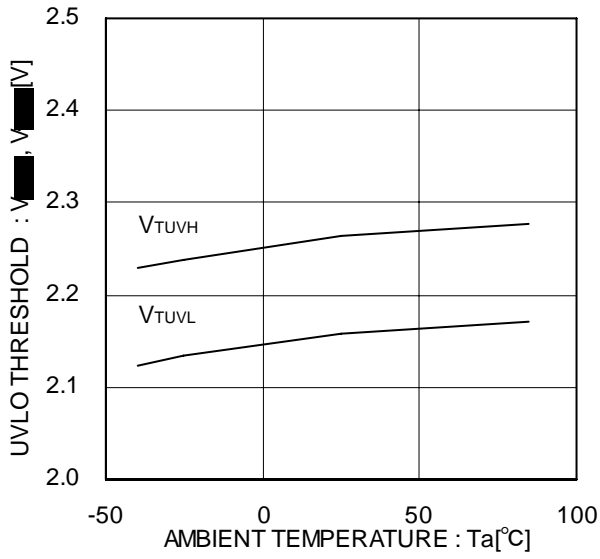

Figure 15. UVLO Threshold

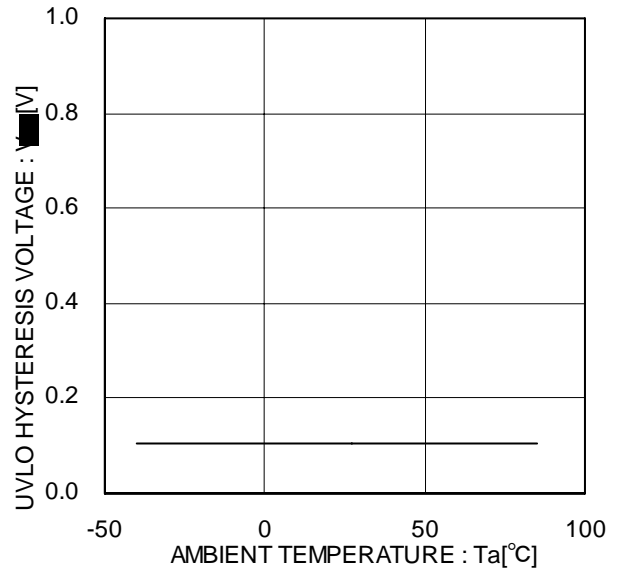

Figure 16. UVLO hysteresis voltage

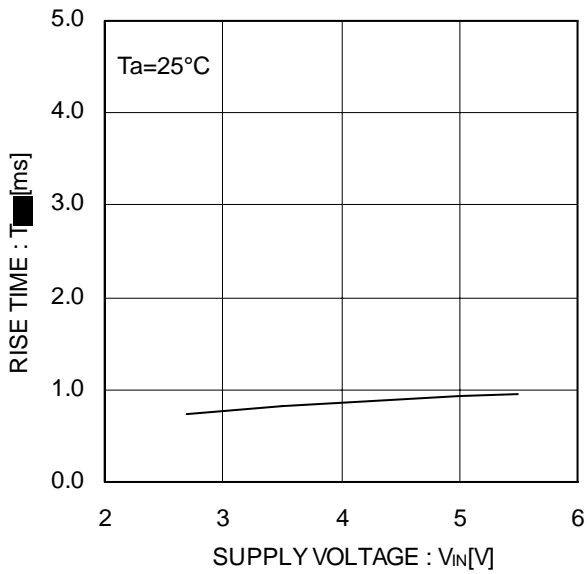

Figure 17. Output rise time

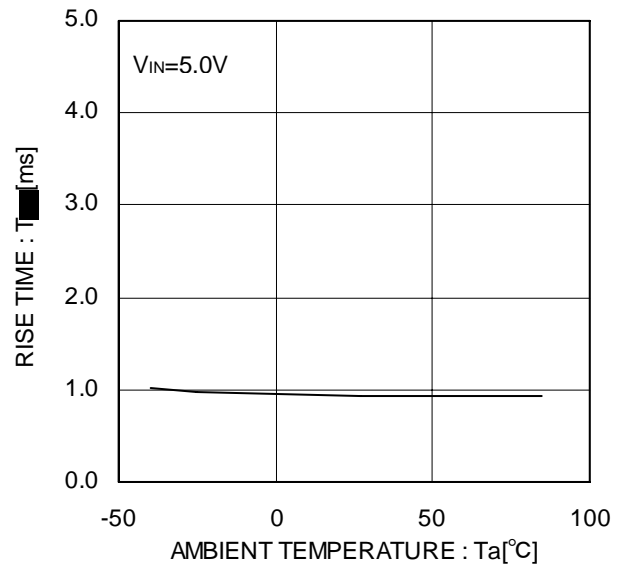

Figure 18. Output rise time

Typical Performance Curves - continued

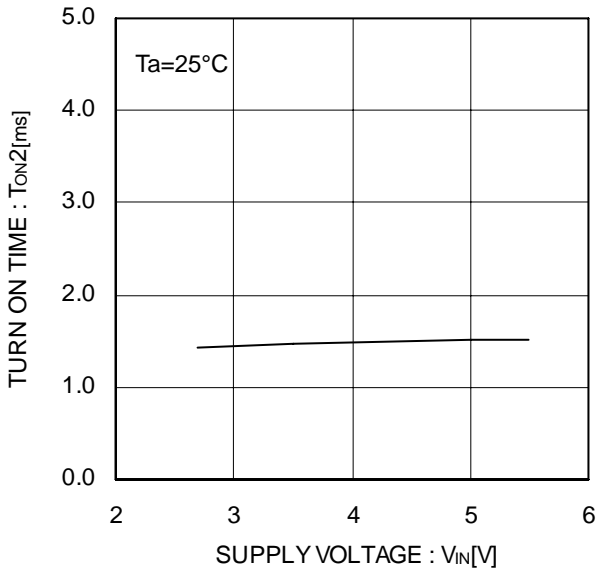

Figure 19. Output turn on time

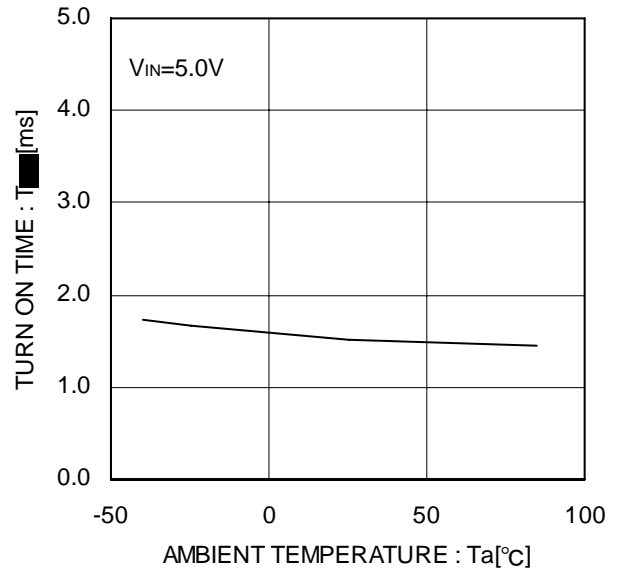

Figure 20. Output turn on time

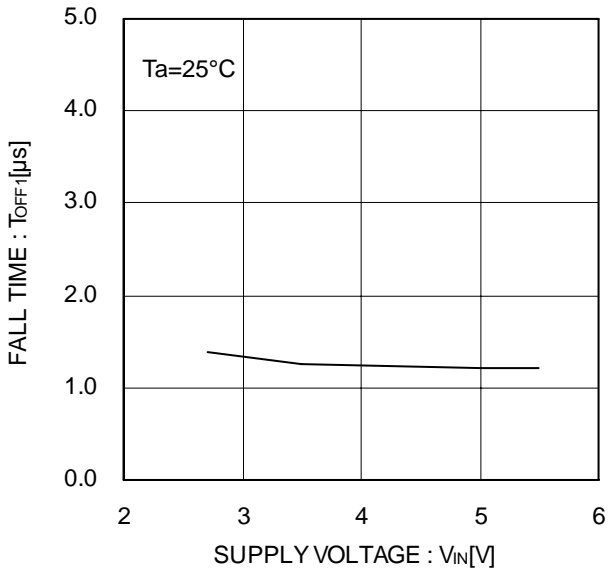

Figure 21. Output fall time

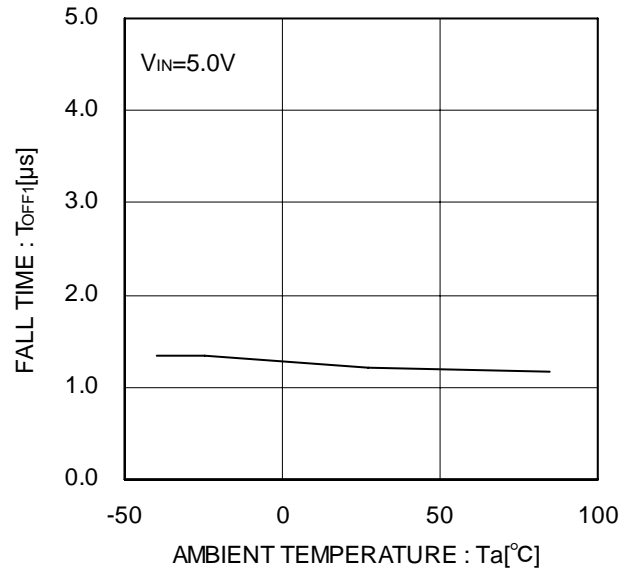

Figure 22. Output fall time

Typical Performance Curves - continued

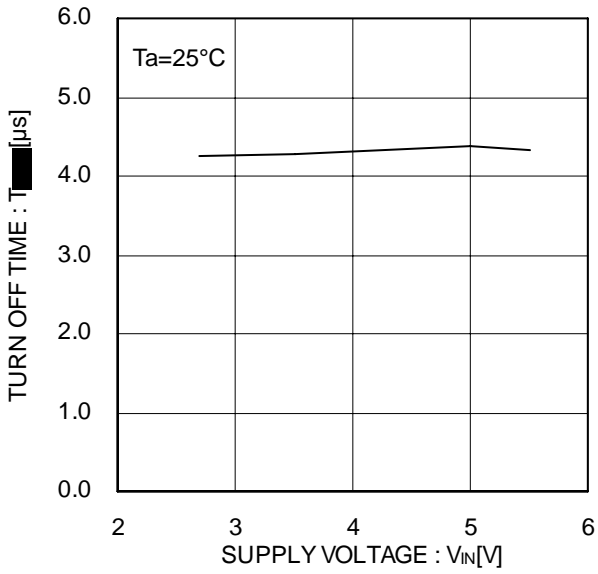

Figure 23. Output turn off time

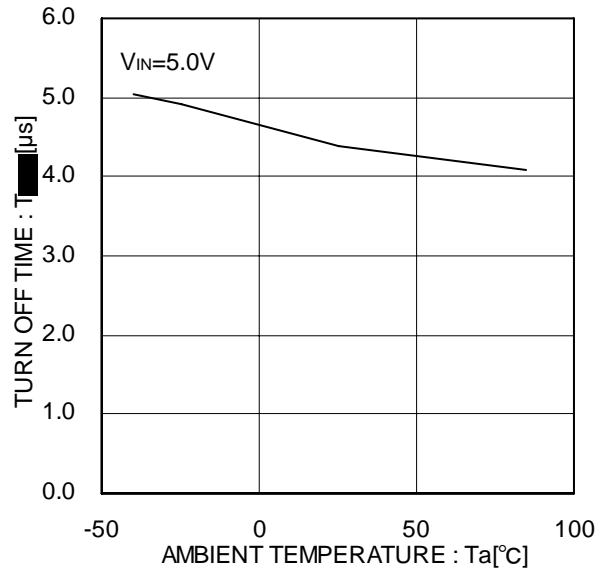

Figure 24. Output turn off time

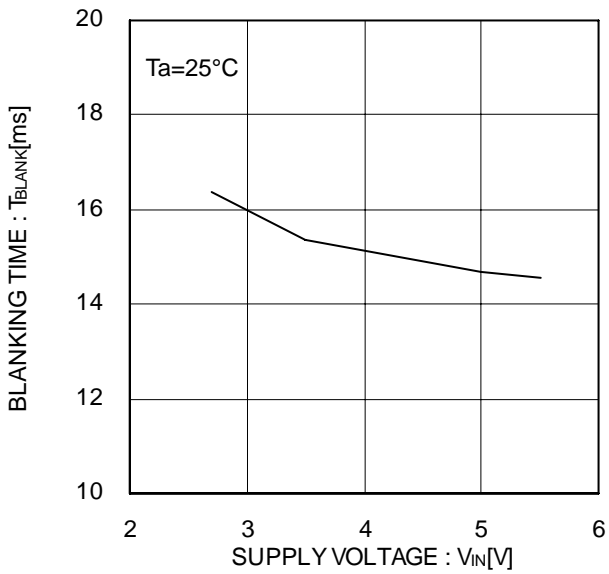

Figure 25. Blanking time

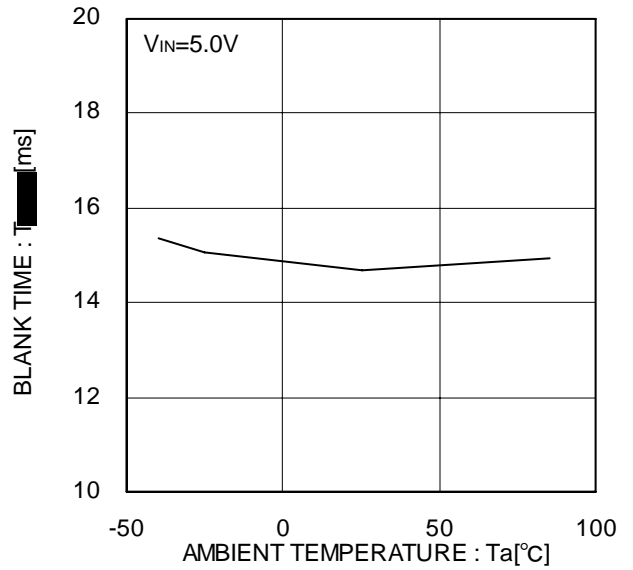

Figure 26. Blanking time

Typical Wave Forms

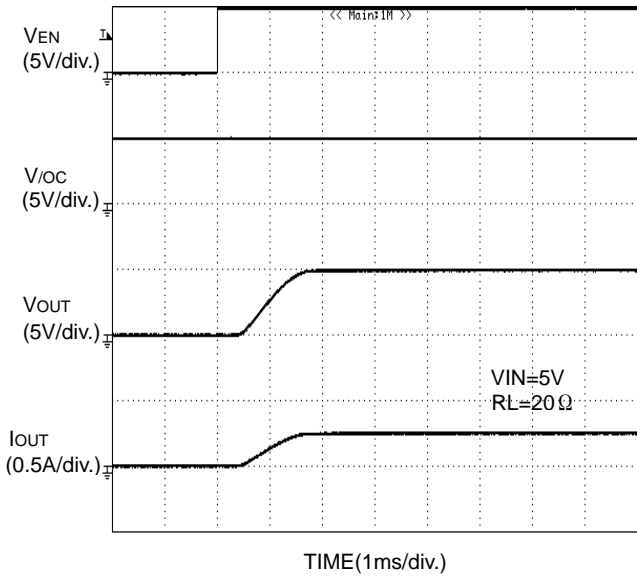

Figure 27. Output rise characteristic

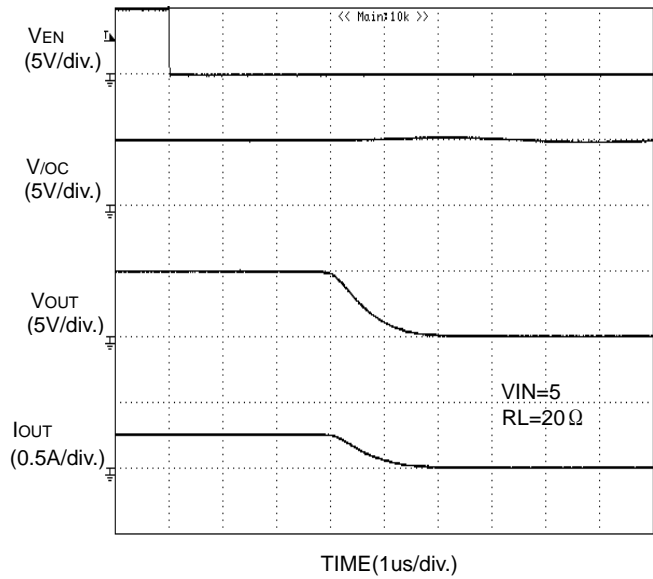

Figure 28. Output fall characteristic

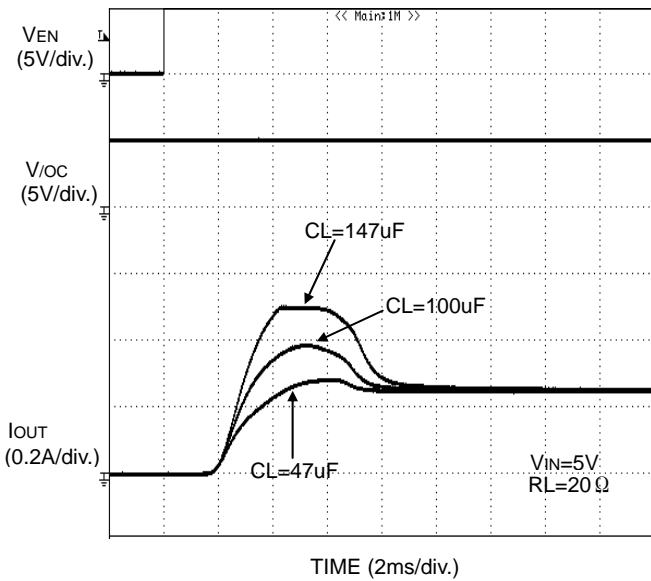

Figure 29. Inrush current response

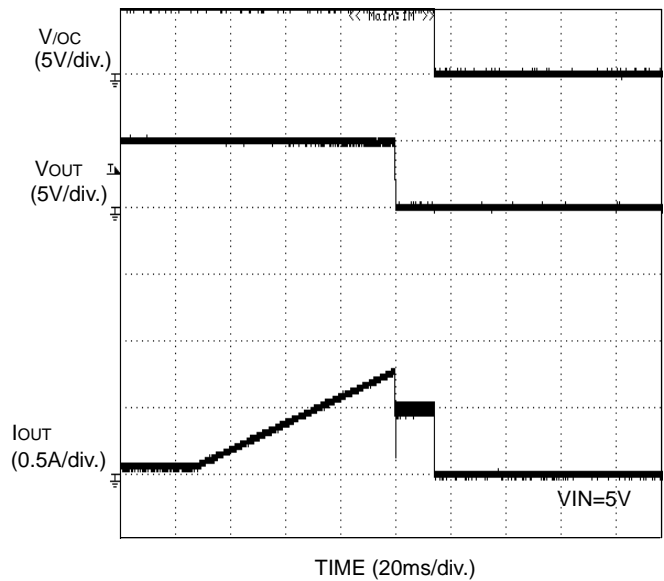

Figure 30. Over current response Ramped load

Typical Wave Forms - continued

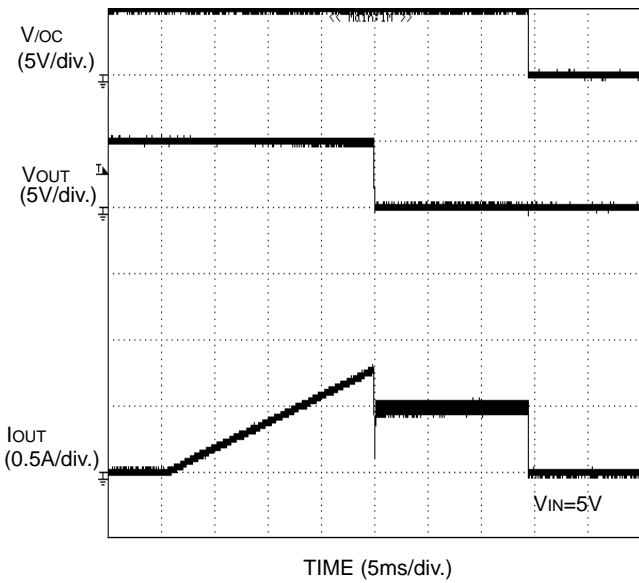

Figure 31. Over current response
Ramped load

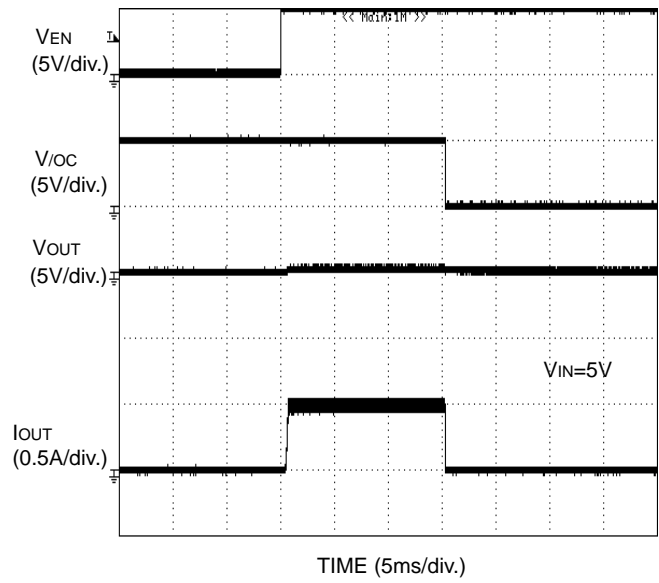

Figure 32. Over current response
Enable to short circuit

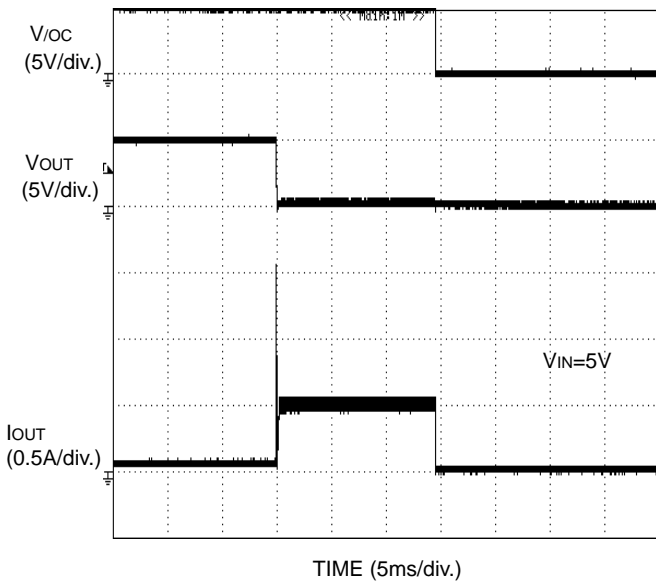

Figure 33. Over current response
Output shortcircuit at Enable

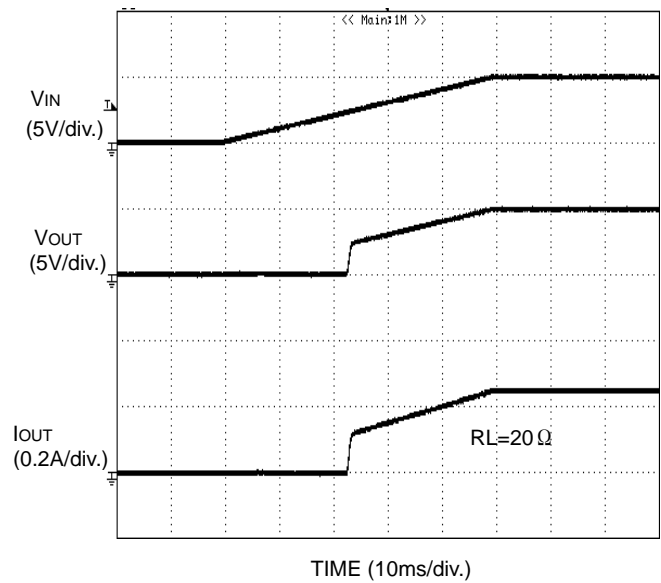

Figure 34. UVLO response
V_{IN} Increasing

Typical Wave Forms - continued

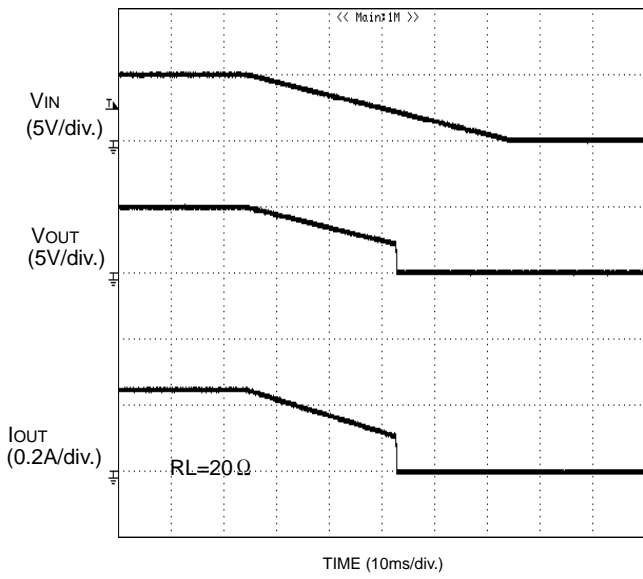
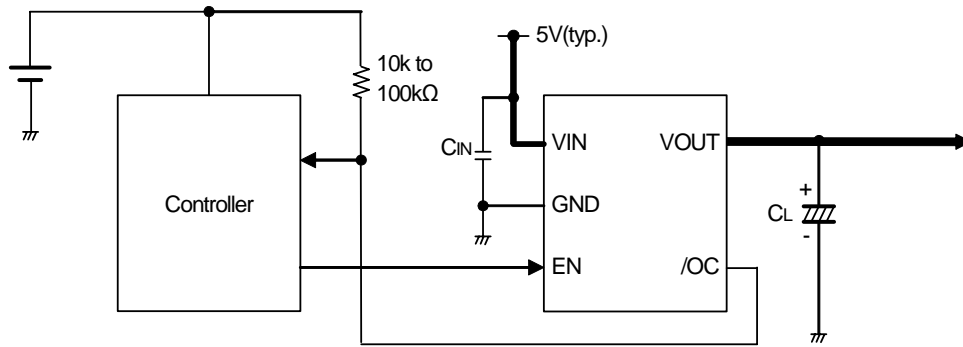

Figure 35. UVLO response
 V_{IN} Decreasing

Typical Application Circuit



Application Information

When excessive current flows owing to output shortcircuit or so, ringing occurs by inductance of power source line to IC, and may cause bad influences upon IC actions. In order to avoid this case, connect a bypass capacitor by IN terminal and GND terminal of IC. 1 μ F or higher is recommended.

Pull up /OC output by resistance 10k Ω to 100k Ω .

Set up value which satisfies the application as CL.

This system connection diagram doesn't guarantee operating as the application.

The external circuit constant and so on is changed and it uses, in which there are adequate margins by taking into account external parts or dispersion of IC including not only static characteristics but also transient characteristics.

Functional Description

1. Overcurrent protection (OCD)

The over-current detection circuit limits current (Isc) and outputs error flag (/OC) when current flowing in each switch MOSFET exceeds a specified value.

The timer is reset when the state of the overcurrent is terminated before passing of T_{BLANK} . After a state of overcurrent is passed at blanking time, the switch is shut down and the overcurrent signal (/OC) changes to Low level.

The latch is reset through its input Low to EN or detects UVLO. Normal operation is returned by EN signal is set to High or UVLO is off. (Figure 36, Figure 37).

There are three types of response against over-current. The over-current detection circuit works when the switch is on (EN, /EN signal is active).

1-1. When the switch is turned on while the output is in shortcircuit status

When the switch is turned on while the output is in shortcircuit status or so, the switch gets in current limit status soon.

1-2. When the output shortcircuits while the switch is on

When the output shortcircuits or large capacity is connected while the switch is on, very large current flows until the over-current limit circuit reacts. When the current detection, limit circuit works, current limitation is carried out.

1-3. When the output current increases gradually

When the output current increases gradually, current limitation does not work until the output current exceeds the over-current detection value. When it exceeds the detection value, current limitation is carried out.

2. Thermal shutdown circuit (TSD)

Thermal shutdown circuit turns off the switch and outputs an error flag (/OC) when the junction temperature exceeds 170°C (typ.). Therefore, when the junction temperature goes down to 150°C (typ), the switch output and an error flag (/OC) are recovered automatically. This operating is repeated until cause of junction temperature increase is removed or EN signal is set Disable. Thermal shutdown circuit works when EN signal is enable.

3. Under voltage lockout (UVLO)

UVLO circuit prevents the switch from turning on until the V_{IN} exceeds 2.3V (Typ.). If the V_{IN} drops below 2.2V (Typ.) while the switch turns on, then UVLO shuts off the power switch. UVLO has hysteresis of a 100mV (Typ.).

Under-voltage lockout circuit works when the switch is on (EN, /EN signal is active).

4. Error flag (/OC) output

Error flag output is N-MOS open drain output. At detection of over-current, thermal shutdown, low level is output.

Over-current detection has delay filter. This delay filter prevents instantaneous current detection such as inrush current at switch on, hot plug from being informed to outside.

Over Current Shutdown Operating

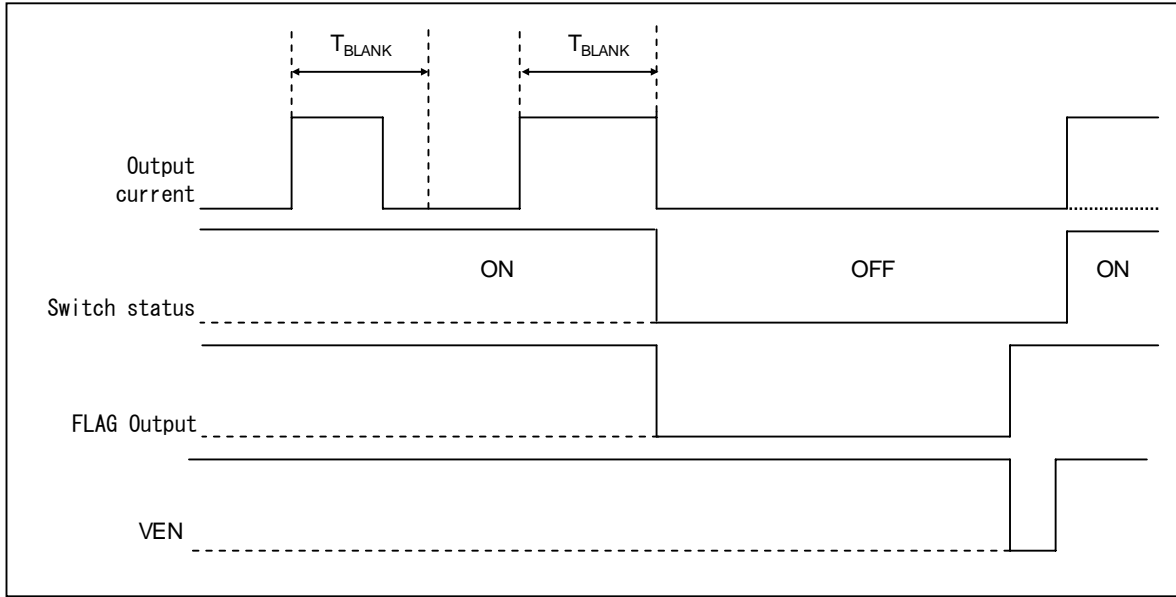

Figure 36. Overcurrent shutdown operation (Reset at toggle of EN)

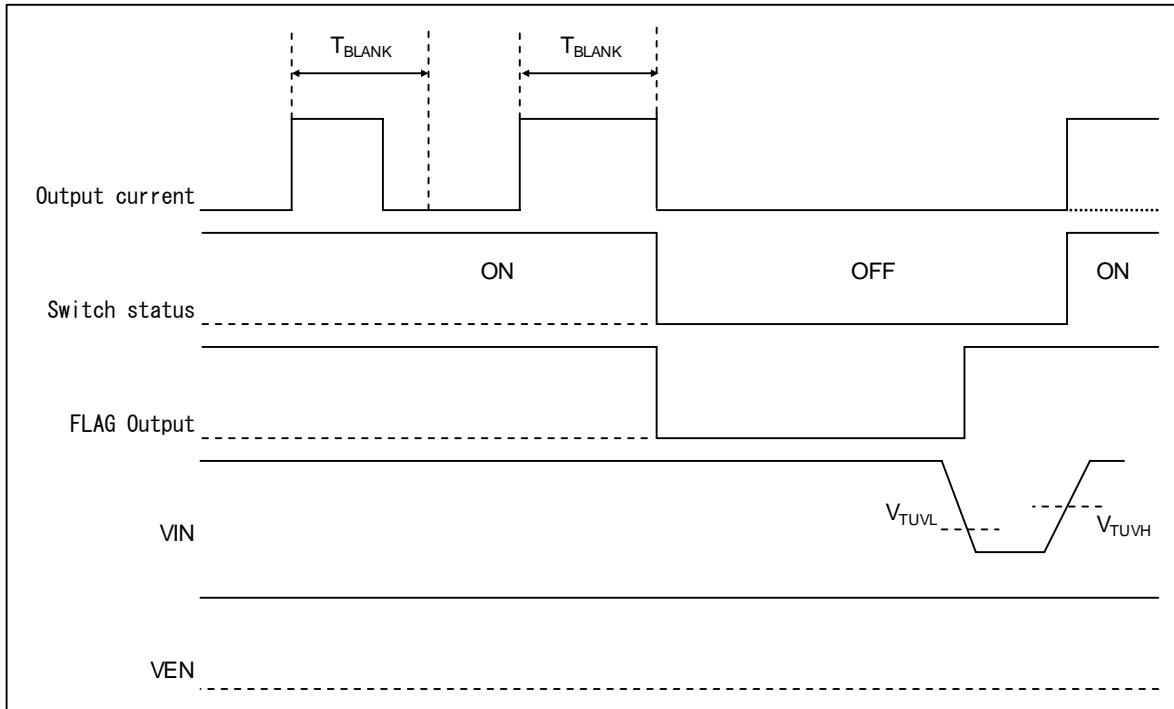
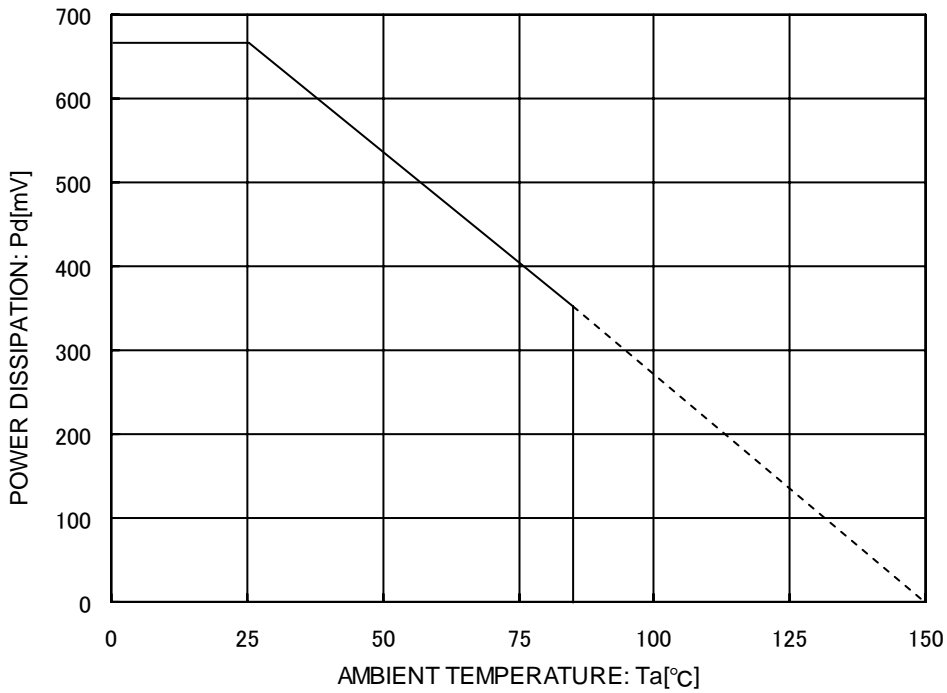

Figure 37. Overcurrent shutdown operation (Reset at reclosing of power supply VIN)

Power Dissipation
(SSOP5 package)



* 70mm * 70mm * 1.6mm : glass epoxy board mounting

Figure 38. Power dissipation curve (Pd-Ta Curve)

I/O Equivalence Circuit

Symbol	Pin No.	Equivalence circuit
EN	3	
VOUT	5	
/OC	4	

Operational Notes

- (1) Absolute Maximum Ratings
An excess in the absolute maximum ratings, such as supply voltage, temperature range of operating conditions, etc., can break down devices, thus making impossible to identify breaking mode such as a short circuit or an open circuit. If any special mode exceeding the absolute maximum ratings is assumed, consideration should be given to take physical safety measures including the use of fuses, etc.
- (2) Operating conditions
These conditions represent a range within which characteristics can be provided approximately as expected. The electrical characteristics are guaranteed under the conditions of each parameter.
- (3) Reverse connection of power supply connector
The reverse connection of power supply connector can break down ICs. Take protective measures against the breakdown due to the reverse connection, such as mounting an external diode between the power supply and the IC's power supply terminal.
- (4) Power supply line
Design PCB pattern to provide low impedance for the wiring between the power supply and the GND lines. In this regard, for the digital block power supply and the analog block power supply, even though these power supplies has the same level of potential, separate the power supply pattern for the digital block from that for the analog block, thus suppressing the diffraction of digital noises to the analog block power supply resulting from impedance common to the wiring patterns. For the GND line, give consideration to design the patterns in a similar manner.
Furthermore, for all power supply terminals to ICs, mount a capacitor between the power supply and the GND terminal. At the same time, in order to use an electrolytic capacitor, thoroughly check to be sure the characteristics of the capacitor to be used present no problem including the occurrence of capacity dropout at a low temperature, thus determining the constant.
- (5) GND voltage
Make setting of the potential of the GND terminal so that it will be maintained at the minimum in any operating state.
Furthermore, check to be sure no terminals are at a potential lower than the GND voltage including an actual electric transient.
- (6) Short circuit between terminals and erroneous mounting
In order to mount ICs on a set PCB, pay thorough attention to the direction and offset of the ICs. Erroneous mounting can break down the ICs. Furthermore, if a short circuit occurs due to foreign matters entering between terminals or between the terminal and the power supply or the GND terminal, the ICs can break down.
- (7) Operation in strong electromagnetic field
Be noted that using ICs in the strong electromagnetic field can malfunction them.
- (8) Inspection with set PCB
On the inspection with the set PCB, if a capacitor is connected to a low-impedance IC terminal, the IC can suffer stress. Therefore, be sure to discharge from the set PCB by each process. Furthermore, in order to mount or dismount the set PCB to/from the jig for the inspection process, be sure to turn OFF the power supply and then mount the set PCB to the jig. After the completion of the inspection, be sure to turn OFF the power supply and then dismount it from the jig. In addition, for protection against static electricity, establish a ground for the assembly process and pay thorough attention to the transportation and the storage of the set PCB.
- (9) Input terminals
In terms of the construction of IC, parasitic elements are inevitably formed in relation to potential. The operation of the parasitic element can cause interference with circuit operation, thus resulting in a malfunction and then breakdown of the input terminal. Therefore, pay thorough attention not to handle the input terminals, such as to apply to the input terminals a voltage lower than the GND respectively, so that any parasitic element will operate. Furthermore, do not apply a voltage to the input terminals when no power supply voltage is applied to the IC. In addition, even if the power supply voltage is applied, apply to the input terminals a voltage lower than the power supply voltage or within the guaranteed value of electrical characteristics.
- (10) Ground wiring pattern
If small-signal GND and large-current GND are provided, It will be recommended to separate the large-current GND pattern from the small-signal GND pattern and establish a single ground at the reference point of the set PCB so that resistance to the wiring pattern and voltage fluctuations due to a large current will cause no fluctuations in voltages of the small-signal GND. Pay attention not to cause fluctuations in the GND wiring pattern of external parts as well.
- (11) External capacitor
In order to use a ceramic capacitor as the external capacitor, determine the constant with consideration given to a degradation in the nominal capacitance due to DC bias and changes in the capacitance due to temperature, etc.
- (12) Thermal shutdown circuit (TSD)
When junction temperatures become detected temperatures or higher, the thermal shutdown circuit operates and turns a switch OFF. The thermal shutdown circuit, which is aimed at isolating the LSI from thermal runaway as much as possible. Do not continuously use the LSI with this circuit operating or use the LSI assuming its operation.
- (13) Thermal design
Perform thermal design in which there are adequate margins by taking into account the power dissipation (Pd) in actual states of use.

Ordering Information

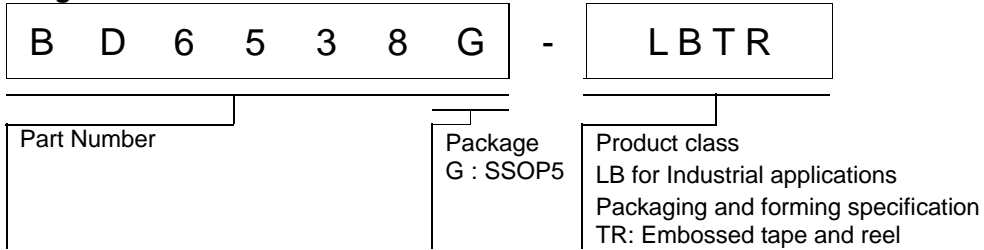

Marking Diagram

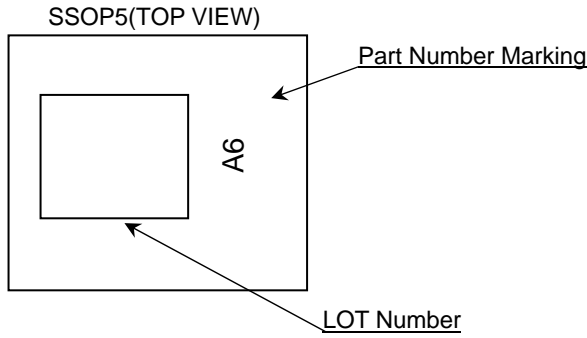

Physical Dimension Tape and Reel Information

Package Name	SSOP5
--------------	-------

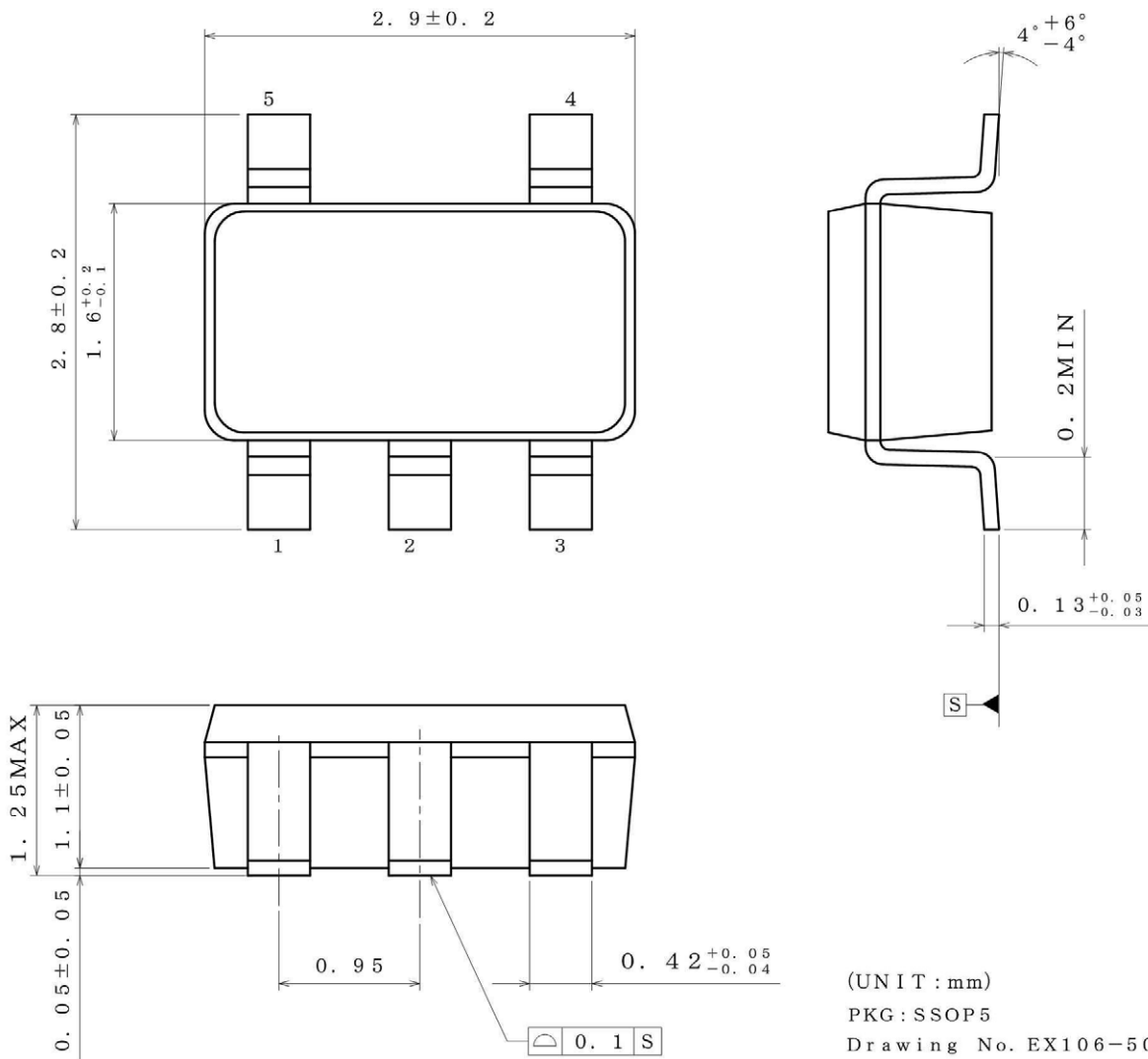

< Tape and Reel Information >

Tape	Embossed carrier tape
Quantity	3000pcs
Direction of feed	TR (The direction is the 1pin of product is at the upper right when you hold) reel on the left hand and you pull out the tape on the right hand



Revision History

Date	Revision	Changes
13.Mar.2013	001	New Release
21.Feb.2014	002	Delete sentence "and log life cycle" in General Description and Futures (page 1). Change "Industrial Applications" to "Industrial Equipment" in Applications (page 1). Applied new style ("title" and "Ordering Information").

Notice

Precaution on using ROHM Products

1. If you intend to use our Products in devices requiring extremely high reliability (such as medical equipment ^(Note 1), aircraft/spacecraft, nuclear power controllers, etc.) and whose malfunction or failure may cause loss of human life, bodily injury or serious damage to property ("Specific Applications"), please consult with the ROHM sales representative in advance. Unless otherwise agreed in writing by ROHM in advance, ROHM shall not be in any way responsible or liable for any damages, expenses or losses incurred by you or third parties arising from the use of any ROHM's Products for Specific Applications.

(Note1) Medical Equipment Classification of the Specific Applications

JAPAN	USA	EU	CHINA
CLASS III	CLASS III	CLASS II b	CLASS III
CLASS IV		CLASS III	

2. ROHM designs and manufactures its Products subject to strict quality control system. However, semiconductor products can fail or malfunction at a certain rate. Please be sure to implement, at your own responsibilities, adequate safety measures including but not limited to fail-safe design against the physical injury, damage to any property, which a failure or malfunction of our Products may cause. The following are examples of safety measures:
 - [a] Installation of protection circuits or other protective devices to improve system safety
 - [b] Installation of redundant circuits to reduce the impact of single or multiple circuit failure
3. Our Products are not designed under any special or extraordinary environments or conditions, as exemplified below. Accordingly, ROHM shall not be in any way responsible or liable for any damages, expenses or losses arising from the use of any ROHM's Products under any special or extraordinary environments or conditions. If you intend to use our Products under any special or extraordinary environments or conditions (as exemplified below), your independent verification and confirmation of product performance, reliability, etc, prior to use, must be necessary:
 - [a] Use of our Products in any types of liquid, including water, oils, chemicals, and organic solvents
 - [b] Use of our Products outdoors or in places where the Products are exposed to direct sunlight or dust
 - [c] Use of our Products in places where the Products are exposed to sea wind or corrosive gases, including Cl₂, H₂S, NH₃, SO₂, and NO₂
 - [d] Use of our Products in places where the Products are exposed to static electricity or electromagnetic waves
 - [e] Use of our Products in proximity to heat-producing components, plastic cords, or other flammable items
 - [f] Sealing or coating our Products with resin or other coating materials
 - [g] Use of our Products without cleaning residue of flux (even if you use no-clean type fluxes, cleaning residue of flux is recommended); or Washing our Products by using water or water-soluble cleaning agents for cleaning residue after soldering
 - [h] Use of the Products in places subject to dew condensation
4. The Products are not subject to radiation-proof design.
5. Please verify and confirm characteristics of the final or mounted products in using the Products.
6. In particular, if a transient load (a large amount of load applied in a short period of time, such as pulse. is applied, confirmation of performance characteristics after on-board mounting is strongly recommended. Avoid applying power exceeding normal rated power; exceeding the power rating under steady-state loading condition may negatively affect product performance and reliability.
7. De-rate Power Dissipation (Pd) depending on Ambient temperature (Ta). When used in sealed area, confirm the actual ambient temperature.
8. Confirm that operation temperature is within the specified range described in the product specification.
9. ROHM shall not be in any way responsible or liable for failure induced under deviant condition from what is defined in this document.

Precaution for Mounting / Circuit board design

1. When a highly active halogenous (chlorine, bromine, etc.) flux is used, the residue of flux may negatively affect product performance and reliability.
2. In principle, the reflow soldering method must be used; if flow soldering method is preferred, please consult with the ROHM representative in advance.

For details, please refer to ROHM Mounting specification

Precautions Regarding Application Examples and External Circuits

1. If change is made to the constant of an external circuit, please allow a sufficient margin considering variations of the characteristics of the Products and external components, including transient characteristics, as well as static characteristics.
2. You agree that application notes, reference designs, and associated data and information contained in this document are presented only as guidance for Products use. Therefore, in case you use such information, you are solely responsible for it and you must exercise your own independent verification and judgment in the use of such information contained in this document. ROHM shall not be in any way responsible or liable for any damages, expenses or losses incurred by you or third parties arising from the use of such information.

Precaution for Electrostatic

This Product is electrostatic sensitive product, which may be damaged due to electrostatic discharge. Please take proper caution in your manufacturing process and storage so that voltage exceeding the Products maximum rating will not be applied to Products. Please take special care under dry condition (e.g. Grounding of human body / equipment / solder iron, isolation from charged objects, setting of ionizer, friction prevention and temperature / humidity control).

Precaution for Storage / Transportation

1. Product performance and soldered connections may deteriorate if the Products are stored in the places where:
 - [a] the Products are exposed to sea winds or corrosive gases, including Cl₂, H₂S, NH₃, SO₂, and NO₂
 - [b] the temperature or humidity exceeds those recommended by ROHM
 - [c] the Products are exposed to direct sunshine or condensation
 - [d] the Products are exposed to high Electrostatic
2. Even under ROHM recommended storage condition, solderability of products out of recommended storage time period may be degraded. It is strongly recommended to confirm solderability before using Products of which storage time is exceeding the recommended storage time period.
3. Store / transport cartons in the correct direction, which is indicated on a carton with a symbol. Otherwise bent leads may occur due to excessive stress applied when dropping of a carton.
4. Use Products within the specified time after opening a humidity barrier bag. Baking is required before using Products of which storage time is exceeding the recommended storage time period.

Precaution for Product Label

QR code printed on ROHM Products label is for ROHM's internal use only.

Precaution for Disposition

When disposing Products please dispose them properly using an authorized industry waste company.

Precaution for Foreign Exchange and Foreign Trade act

Since our Products might fall under controlled goods prescribed by the applicable foreign exchange and foreign trade act, please consult with ROHM representative in case of export.

Precaution Regarding Intellectual Property Rights

1. All information and data including but not limited to application example contained in this document is for reference only. ROHM does not warrant that foregoing information or data will not infringe any intellectual property rights or any other rights of any third party regarding such information or data. ROHM shall not be in any way responsible or liable for infringement of any intellectual property rights or other damages arising from use of such information or data.:
2. No license, expressly or implied, is granted hereby under any intellectual property rights or other rights of ROHM or any third parties with respect to the information contained in this document.

Other Precaution

1. This document may not be reprinted or reproduced, in whole or in part, without prior written consent of ROHM.
2. The Products may not be disassembled, converted, modified, reproduced or otherwise changed without prior written consent of ROHM.
3. In no event shall you use in any way whatsoever the Products and the related technical information contained in the Products or this document for any military purposes, including but not limited to, the development of mass-destruction weapons.
4. The proper names of companies or products described in this document are trademarks or registered trademarks of ROHM, its affiliated companies or third parties.

General Precaution

1. Before you use our Products, you are requested to carefully read this document and fully understand its contents. ROHM shall not be in any way responsible or liable for failure, malfunction or accident arising from the use of any ROHM's Products against warning, caution or note contained in this document.
2. All information contained in this document is current as of the issuing date and subject to change without any prior notice. Before purchasing or using ROHM's Products, please confirm the latest information with a ROHM sales representative.
3. The information contained in this document is provided on an "as is" basis and ROHM does not warrant that all information contained in this document is accurate and/or error-free. ROHM shall not be in any way responsible or liable for any damages, expenses or losses incurred by you or third parties resulting from inaccuracy or errors of or concerning such information.

Mouser Electronics

Authorized Distributor

Click to View Pricing, Inventory, Delivery & Lifecycle Information:

[ROHM Semiconductor:](#)

[BD6538G-LBTR](#)