

PMC Panel Mount Power Supply

24V / 5V 100W Dual Output / PMC-DSPV100W1A

PMC

Highlights & Features

- Universal AC input voltage range
- Power will not de-rate for the entire input voltage range
- Full corrosion resistant aluminium casing
- Conforms to harmonics current IEC/EN 61000-3-2, Class A
- High MTBF > 700,000 hrs as per Telcordia SR-332
- Safety approval according to IEC/EN/UL 60950-1, IEC/EN/UL 62368-1 and EMI to EN 55022, Class B

Safety Standards



CB Certified for worldwide use



Model Number: PMC-DSPV100W1A
Unit Weight: 0.52 kg (1.15 lb)
Dimensions (L x W x D): 178 x 97 x 38 mm
 (7.01 x 3.82 x 1.50 inch)

General Description

Delta's PMC series of panel mount power supply offers dual output voltage 24V & 5V, a wide temperature range from -10°C to +70°C and a highly dependable minimum hold-up time. The state-of-the-art design is made to withstand harsh industrial environments. What makes the product stands out from the crowd is its lightweight full aluminium body design, which can withstand shock and vibration according to IEC60068-2. The PMC series also offers overvoltage and overload protection. Using a wide input voltage range design, it is compatible worldwide. The input also includes DC operating voltage from 125-375Vdc. Best of all, this excellent design and quality does not come with a big price tag.

Model Information

PMC Panel Mount Power Supply

Model Number	Input Voltage Range	Rated Output Voltage	Rated Output Current
PMC-DSPV100W1A	85-264Vac (125-375Vdc)	V1: 24V V2: 5V	V1: 2.7A V2: 7.0A

Model Numbering

PMC –	D	SPV	100W	1	A
PMC Series	Dual O/P	S: 24V Output Voltage P: 5V Output Voltage V: Voltage	Output Power	Single Phase	Delta Standard

PMC Panel Mount Power Supply

24V / 5V 100W Dual Output / PMC-DSPV100W1A

Specifications

Input Ratings / Characteristics

Nominal Input Voltage	100-240Vac
Input Voltage Range	85-264Vac
Nominal Input Frequency	50-60Hz
Input Frequency Range	47-63Hz
Nominal DC Input Voltage	125-250Vdc
DC Input Voltage Range	125-375Vdc
Input Current	< 2.0A @ 115Vac, < 1.1A @ 230Vac
Efficiency at 100% Load	> 84% @ 115Vac, > 86% @ 230Vac
Max Inrush Current (Cold Start)	< 50A @ 115Vac, < 100A @ 230Vac
Leakage Current	< 1mA @ 240Vac

Output Ratings / Characteristics

Nominal Output Voltage	V1: 24V, V2: 5V
Output Voltage Tolerance	V1: $\pm 2\%$ (initial set point tolerance from factory) V2: fixed
Output Voltage Adjustment Range	V1: 22.8-26.4Vdc, V2: 5V fixed
Output Current	V1: 2.7A rated (0.3-4.0A), V2: 7.0A rated (0.8-7.0A)
Output Power*	100W
Line Regulation	0.5% typ. (@ 85-264Vac input, 100% load)
Load Regulation	1% typ. (@ 85-264Vac input, V1: 100% rated load and V2: 60% rated load and vice versa)
PARD** (20MHz)	V1: <200mVpp, V2: <80mVpp
Rise Time	V1: <30ms, V2: <20ms @ nominal input (100% load)
Start-up Time	< 1000ms @ nominal input (100% load)
Hold-up Time	> 15ms @ 115Vac, > 80ms @ 230Vac (100% load)
Dynamic Response (Overshoot & Undershoot O/P Voltage)	$\pm 5\%$ @ V1: 0-100% rated load and V2: 60% rated load and vice versa (Slew Rate: 0.1A/ μ S)
Start-up with Capacitive Loads	V1: 4,000 μ F Max

* Combination of output power at V1 + V2 shall keep within 100W. For example: V1: 24V/4A (96W), V2: 5V/0.8A (4W) or V1: 24V/2.7A (65W), V2: 5V/7A (35W).

** PARD is measured with an AC coupling mode, and in parallel with 0.1 μ F ceramic capacitor & 47 μ F electrolytic capacitor.

Mechanical

Case Cover	Aluminium
Dimensions (L x W x D)	178 x 97 x 38 mm (7.01 x 3.82 x 1.50 inch)
Unit Weight	0.52 kg (1.15 lb)
Indicator	Green LED DC OK
Cooling System	Convection
Terminal	Input and Output M3.5 x 7 Pins (Rated 300V/15A)
Wire	AWG 20-14
Noise (1 Meter from power supply)	Sound Pressure Level (SPL) <40dBA

PMC Panel Mount Power Supply

24V / 5V 100W Dual Output / PMC-DSPV100W1A

Environment

Surrounding Air Temperature	Operating	-10°C to +70°C
	Storage	-25°C to +85°C
Power De-rating		> 50°C de-rate power by 2.5% / °C
Operating Humidity		5 to 95% RH (Non-Condensing)
Operating Altitude		0 to 3,000 Meters (9,840 ft.)
Shock Test	Non-Operating	IEC60068-2-27, 30G (300m/S ²) for a duration of 18ms 3 times per direction, 18 times in total
Vibration	Non-Operating	IEC60068-2-6, 10Hz to 150Hz @ 50m/S ² (5G peak); 20 min per axis for all X, Y, Z direction
Pollution Degree		2

Protections

Overvoltage	V1: < 32.4V, V2: 6.75V, Hiccup Mode, Non-Latching (Auto recovery).
Overload / Overcurrent	OLP: > 150% of total rated output power, Hiccup Mode, Non-Latching (Auto recovery). OCP: Hiccup Mode, Non-Latching (Auto recovery) <ul style="list-style-type: none"> V1: 3-6A, V2: rated current, protect both V1&V2 V2: 8-12A, V1: rated current, protect only V2 and V1 still remain
Over Temperature	< 75°C Surrounding Air Temperature @ 100% load, Non-Latching (Auto-recovery).
Short Circuit	Hiccup Mode, Non-Latching (Auto-recovery when the fault is removed)
Protection Against Shock	Class I with PE* connection

*PE: Primary Earth

Reliability Data

MTBF	> 700,000 hrs. per Telcordia SR-332 I/P: 115Vac, O/P: 100% load, Ta: 25°C
Expected Cap Life Time	10 years (115Vac & 230Vac, 50% load @ 40°C)

PMC Panel Mount Power Supply

24V / 5V 100W Dual Output / PMC-DSPV100W1A

Safety Standards / Directives

Electrical Safety	TUV Bauart to	EN 60950-1, EN 62368-1
	cRUus	UL 60950-1 and CSA C22.2 No. 60950-1 (File No. E191395), UL 62368-1 and CSA C22.2 No. 62368-1 (File No. E191395)
	CB scheme	IEC 60950-1, IEC 62368-1
CCC		GB4943
CE		In conformance with EMC Directive 2014/30/EU and Low Voltage Directive 2014/35/EU
Galvanic Isolation	Input to Output	3.0KVac
	Input to Ground	1.5KVac
	Output to Ground	0.5KVac

EMC

Emissions (CE & RE)		CISPR32, EN55032, FCC Title 47: Class B, GB9254
Immunity to		EN 55024
Electrostatic Discharge	IEC61000-4-2	Level 4 Criteria A ¹⁾ Air Discharge: 15kV Contact Discharge: 8kV
Radiated Field	IEC61000-4-3	Level 2 Criteria A ¹⁾ 80MHz-1GHz, 3V/M with 1kHz tone / 80% modulation
Electrical Fast Transient / Burst	IEC61000-4-4	Level 3 Criteria A ¹⁾ 2kV
Surge	IEC61000-4-5	Level 3 Criteria A ¹⁾ Common Mode ²⁾ : 2kV Differential Mode ³⁾ : 2kV
Conducted	IEC61000-4-6	Level 2 Criteria A ¹⁾ 150kHz-80MHz, 3Vrms
Power Frequency Magnetic Fields	IEC61000-4-8	Criteria A ¹⁾ 1A/Meter
Voltage Dips	IEC61000-4-11	100% dip; 1 cycle (20ms); Self Recoverable
Low Energy Pulse Test (Ring Wave)	IEC61000-4-12	Level 3 Criteria A ¹⁾ Common Mode ²⁾ : 2kV Differential Mode ³⁾ : 1kV

1) Criteria A: Normal performance within the specification limits

2) Asymmetrical: Common mode (Line to earth)

3) Symmetrical: Differential mode (Line to line)

PMC Panel Mount Power Supply

24V / 5V 100W Dual Output / PMC-DSPV100W1A

Block Diagram

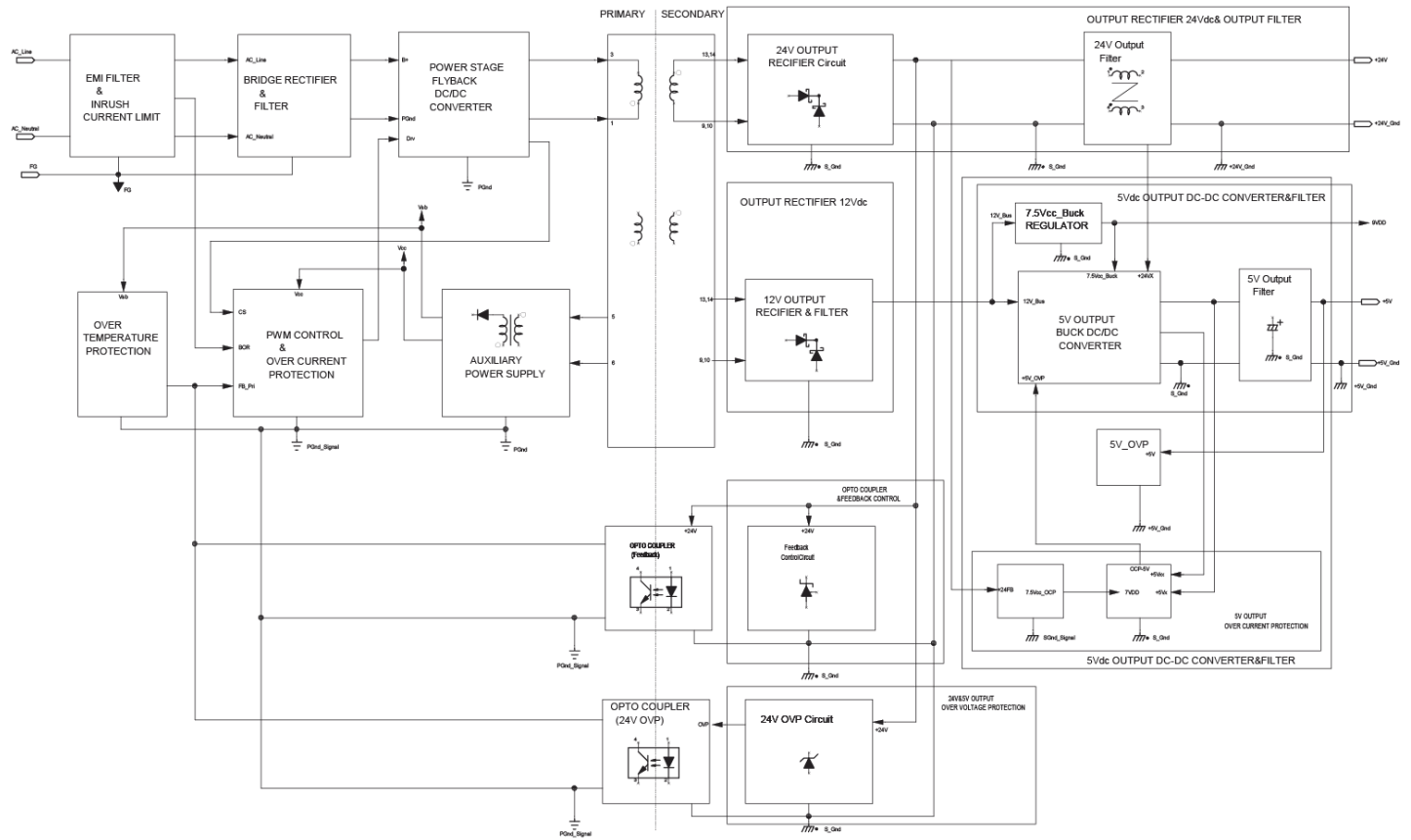

Device Description

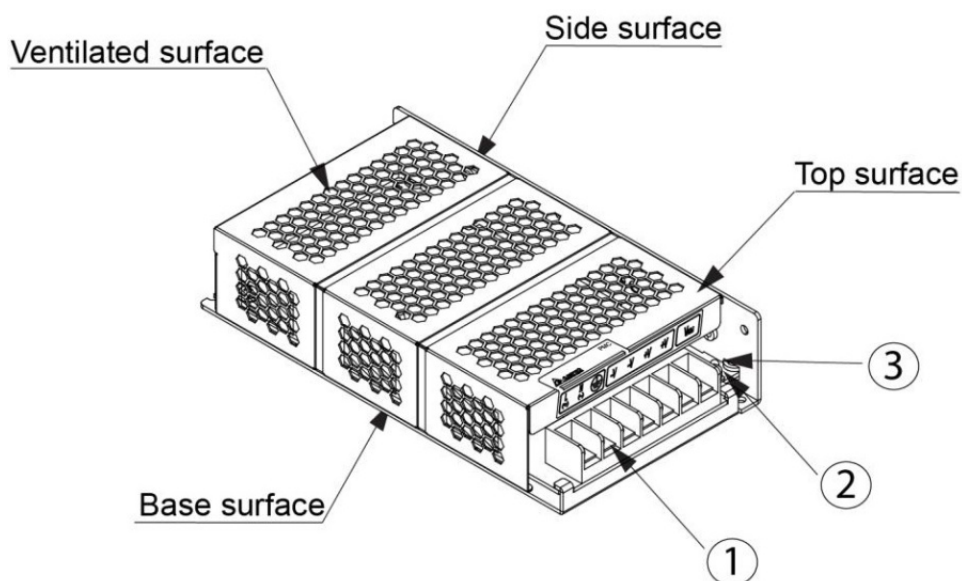

- 1) Input & Output terminal block connector
- 2) DC Voltage adjustment potentiometer of V1: 24V
- 3) DC OK control LED (Green) of V1: 24V

PMC Panel Mount Power Supply

24V / 5V 100W Dual Output / PMC-DSPV100W1A

Dimensions

- **PMC-DSPV100W1A:** Terminal Block
L x W x H: 178 x 97 x 38 mm (7.01 x 3.82 x 1.50 inch)

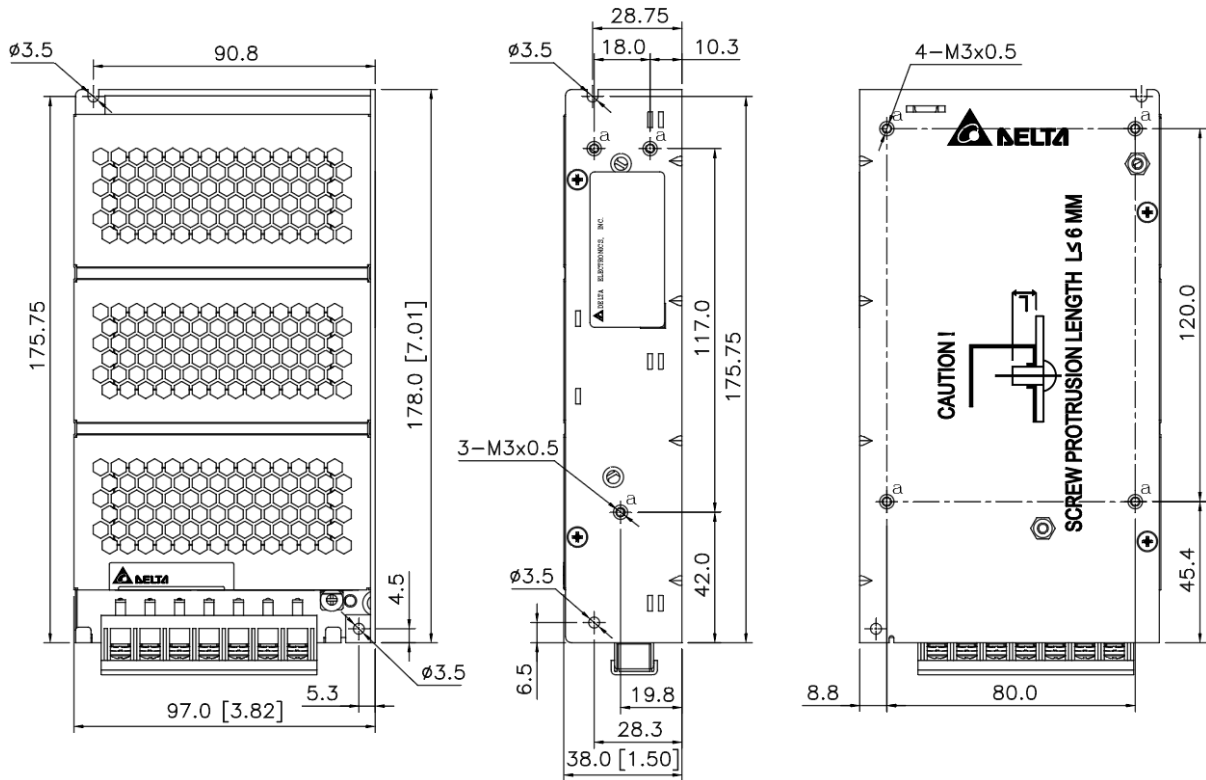

Engineering Data

Output Load De-rating VS Surrounding Air Temperature

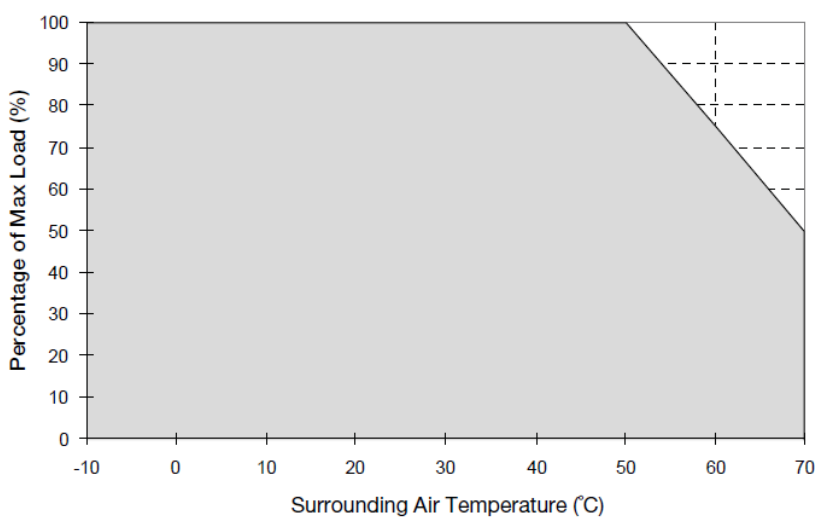

Fig. 1 De-rating for Vertical and Horizontal Mounting Orientation
> 50°C de-rate power by 2.5% / °C

Note

1. Power supply components may degrade, or be damaged, when the power supply is continuously used outside the shaded region, refer to the graph shown in Fig. 1.
2. If the output capacity is not reduced when the surrounding air temperature > 50°C, the device may run into Over Temperature Protection. When activated, the output voltage will go into bouncing mode and will recover when the surrounding air temperature is lowered or the load is reduced as far as necessary to keep the device in working condition.
3. In order for the device to function in the manner intended, it is also necessary to keep a safety distance as recommended in the safety instructions while the device is in operation.
4. Depending on the surrounding air temperature and output load delivered by the power supply, the device housing can be very hot!
5. If the device has to be mounted in any other orientation, please do not hesitate to contact info@deltapsu.com for more details.

PMC Panel Mount Power Supply

24V / 5V 100W Dual Output / PMC-DSPV100W1A

Output Load De-rating VS Input Voltage

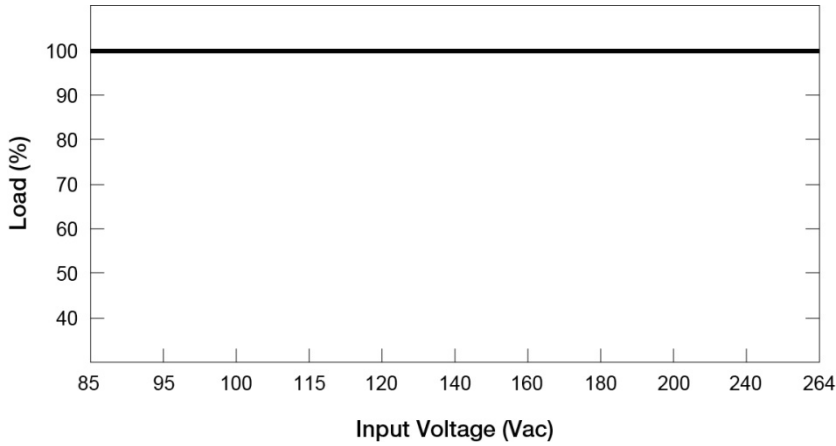

■ No output power de-rating across the entire input voltage range

Assembly & Installation

- Ⓐ Mounting holes for power supply assembly onto the mounting surface.
Power supply shall be mounted on minimum 2 mounting holes using M3 screw minimum 5 mm length.
- Ⓑ This surface belongs to customer's end system or panel where the power supply is mounted.
- Ⓒ Connector.

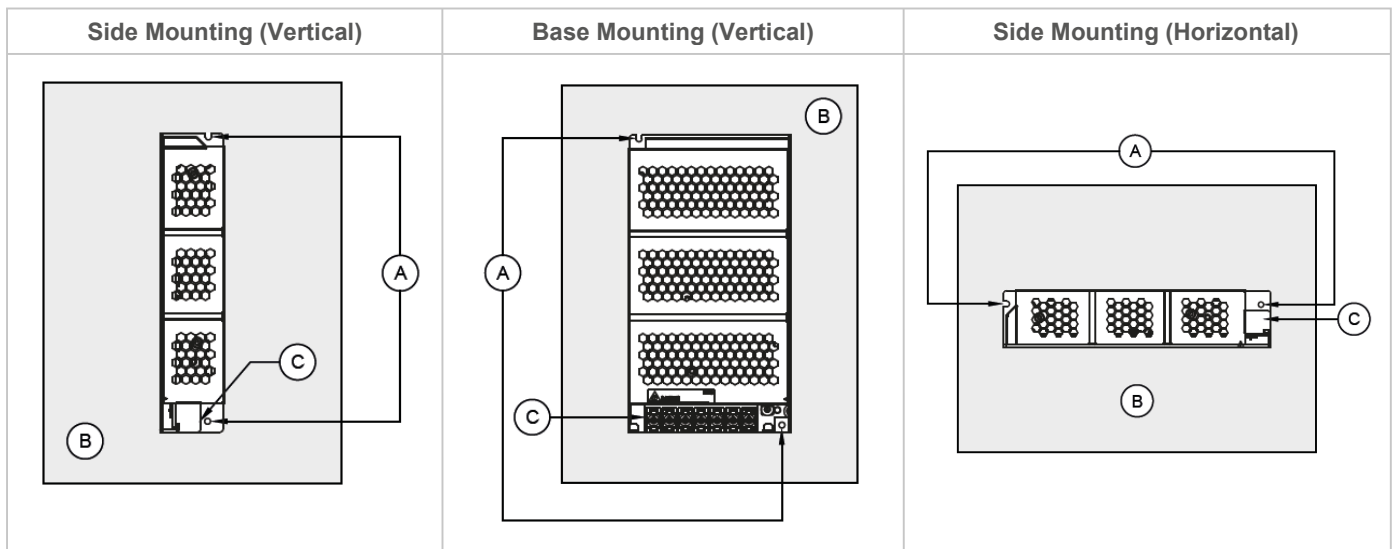

Fig. 2 Mounting Orientation

- Use flexible cable (stranded or solid) of AWG 20-14.
- The torque at the Connector shall not exceed 13Kgf.cm. The insulation stripping length should not exceed 0.275" or 7mm.

PMC Panel Mount Power Supply

24V / 5V 100W Dual Output / PMC-DSPV100W1A

Installation of Mounting Accessories

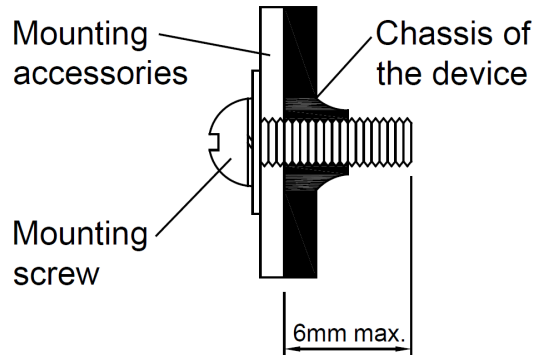

- Only use M3 screw ≤ 6 mm (0.23 inch) through the base mounting holes. This is to keep a safe distance between the screw and internal components.
- Recommended mounting tightening torque : 4~8Kgf.cm

Safety Instructions

- To ensure sufficient convection cooling, always maintain a safety distance of >20 mm (0.78 inch) from all ventilated surfaces while the device is in operation.
- The device is not recommended to be placed on low thermal conductive surface, for example, plastics.
- Note that the enclosure of the device can become very hot depending on the ambient temperature and load of the power supply. Do not touch the device while it is in operation or immediately after power is turned OFF. Risk of burning!
- Do not touch the terminals while power is being supplied. Risk of electric shock.
- Prevent any foreign metal, particles or conductors to enter the device through the openings during installation. It can cause: Electric shock; Safety Hazard; Fire; Product failure
- Warning: When connecting the device, secure Earth connection before connecting L and N. When disconnecting the device, remove L and N connections before removing the Earth connection.

Accessories

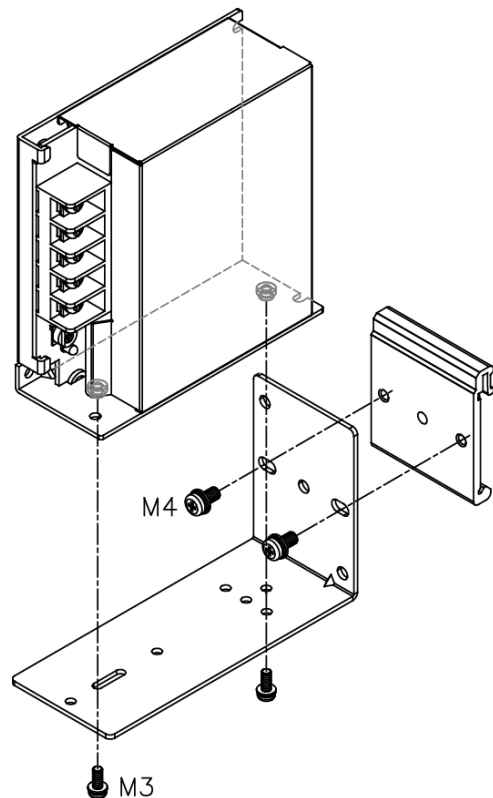

L-02: Latch
P-03: Bracket

These accessories are used to mount the panel mount power supply onto a DIN rail.

PMC Panel Mount Power Supply

24V / 5V 100W Dual Output / PMC-DSPV100W1A

Functions

■ Graph illustrating the Start-up Time, Rise Time, and Hold-up Time

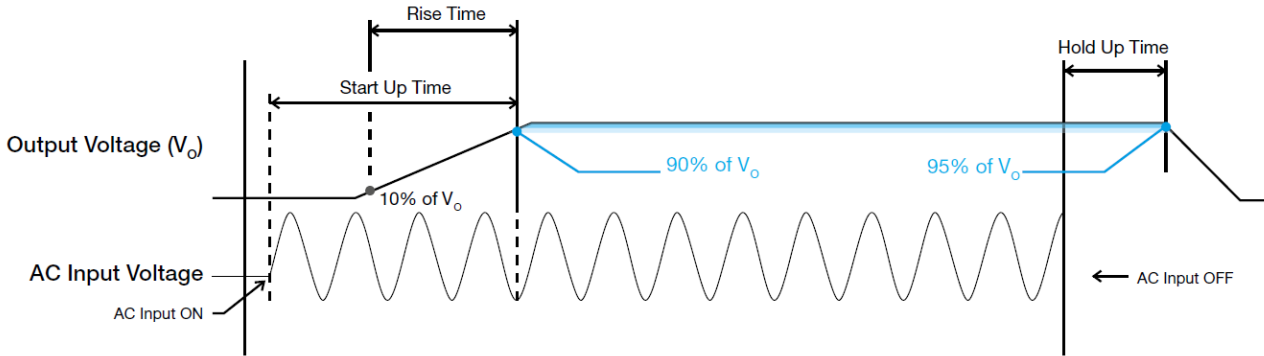

Start-up Time

The time required for the output voltage to reach 90% of its final steady state set value, after the input voltage is applied.

Rise Time

The time required for the output voltage to change from 10% to 90% of its final steady state set value.

Hold-up Time

Time between the collapse of the AC input voltage, and the output falling to 95% of its steady state set value.

Inrush Current

Inrush current is the peak, instantaneous, input current measured and, occurs when the input voltage is first applied. For AC input voltages, the maximum peak value of inrush current will occur during the first half cycle of the applied AC voltage. This peak value decreases exponentially during subsequent cycles of AC voltage.

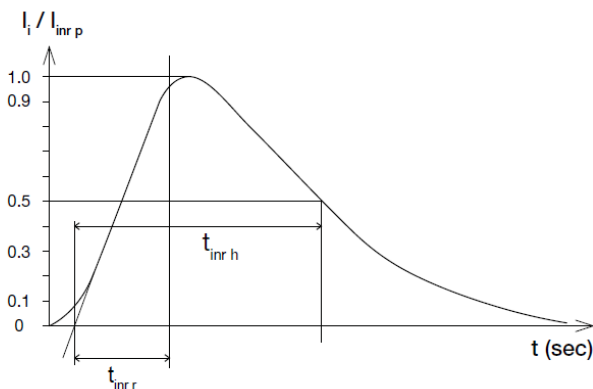

Dynamic Response

The power supply output voltage will remain within $\pm 5\%$ of its steady state value, when subjected to a dynamic load from 0 to 100% of its rated current.

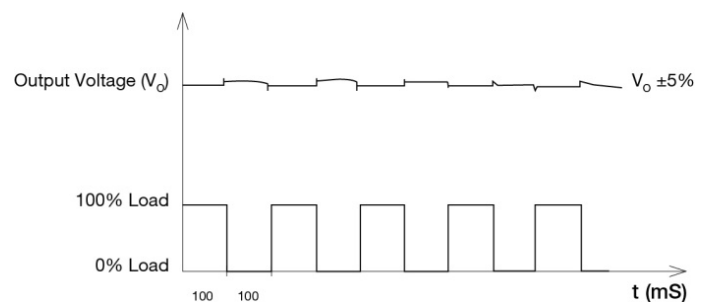

PMC Panel Mount Power Supply

24V / 5V 100W Dual Output / PMC-DSPV100W1A

Overload & Overcurrent Protections (Auto-Recovery)

The power supply's Overload (OLP) and Overcurrent (OCP) Protections will be activated when output current exceeds 150% of I_O (Max load). In such occurrence, the V_O will start to droop and once the power supply has reached its maximum power limit, the protection is activated and the power supply will go into "Hiccup mode" (Auto-Recovery). The power supply will recover once the fault condition of the OLP and OCP is removed and I_O is back within the specifications.

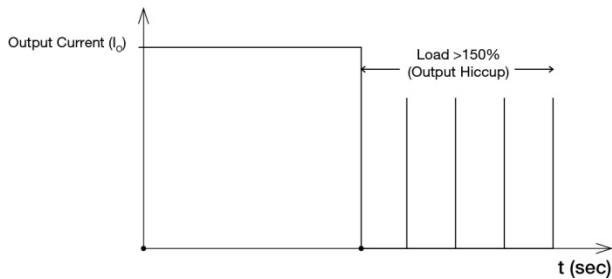

It is not recommended to prolong the duration of I_o when it is $<150\%$ but $>100\%$, since it may cause damage to the PSU.

Short Circuit Protection (Auto-Recovery)

The power supply's output OLP/OCP function also provides protection against short circuits. When a short circuit is applied, the output current will operate in "Hiccup mode", as shown in the illustration in the OLP/OCP section on this page. The power supply will return to normal operation after the short circuit is removed.

Overvoltage Protection (Auto-Recovery)

The power supply's overvoltage circuit will be activated when its internal feedback circuit fails. The output voltage shall not exceed its specifications defined on Page 3 under "Protections".

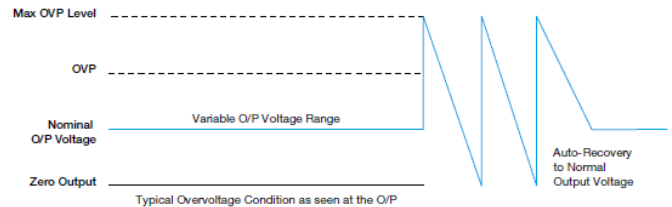

Over Temperature Protection (Auto-Recovery)

As mentioned above, the power supply also has Over Temperature Protection (OTP). In the event of a higher operating temperature at 100% load, the power supply will run into OTP when the operating temperature is beyond what is recommended in the de-rating graph. When activated, the output voltage will go into bouncing mode until the temperature drops to its normal operating temperature as recommended in the de-rating graph.

PMC Panel Mount Power Supply

24V / 5V 100W Dual Output / PMC-DSPV100W1A

Others

PFC – Norm EN 61000-3-2

Line Current harmonic

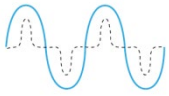

Typically, the input current waveform is not sinusoidal due to the periodical peak charging of the input capacitor. In industrial environment, complying with EN 61000-3-2 is only necessary under special conditions. Complying to this standard can have some technical drawbacks, such as lower efficiency as well as some commercial aspects such as higher purchasing costs. Frequently, the user does not profit from fulfilling this standard, therefore, it is important to know whether it is mandatory to meet this standard for a specific application.

This product conforms to this standard.

Attention

Delta provides all information in the datasheets on an “AS IS” basis and does not offer any kind of warranty through the information for using the product. In the event of any discrepancy between the information in the catalog and datasheets, the datasheets shall prevail (please refer to www.DeltaPSU.com for the latest datasheets information). Delta shall have no liability of indemnification for any claim or action arising from any error for the provided information in the datasheets. Customer shall take its responsibility for evaluation of using the product before placing an order with Delta.

Delta reserves the right to make changes to the information described in the datasheets without notice.